

**SANYO**

INSTRUCTION MANUAL

**SFX-107**

Facsimile Transceiver

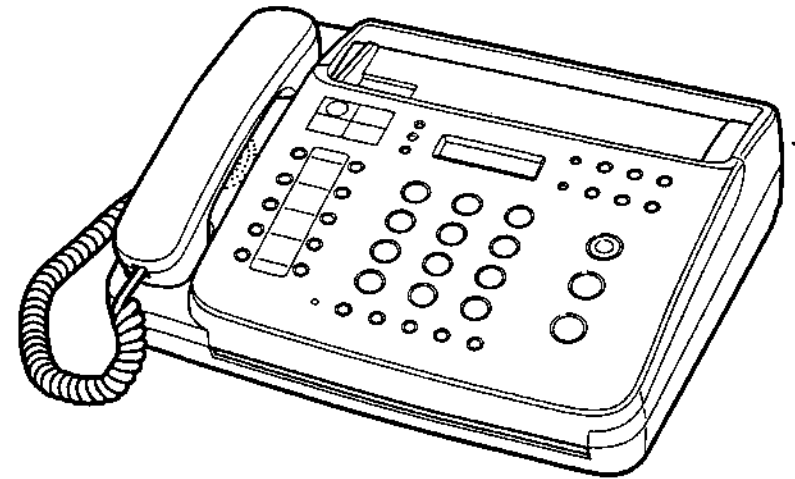

**SANYO**

SANYO Electric Co., Ltd.

# Precautions

---

## Placement precautions

- Avoid placing the unit in humid or dusty places, or in places where it will be exposed to excessive heat (direct sunlight, heaters, etc.).
- Do not step on or set anything on the AC cord. **DAMAGE TO THE AC CORD IS A SAFETY RISK AND CAN CAUSE A FIRE.**
- Install the unit only on a stable surface.
- Do not connect the unit in the same AC power wall outlet as appliances that generate large amounts of interference (heaters with thermostats, appliances with motors, etc.). It is best to use a completely separate electrical outlet.
- Keep the unit away from water. If water accidentally enters the unit, unplug the power cord immediately. **DO NOT PLUG THE UNIT AGAIN.** Contact an authorized Sanyo service center or dealer.

## Handling precautions

- Do not remove any parts that are held in place with screws. (The unit does not contain any user-serviceable items.)
- Maintain standard room temperature 5°C-35°C (41°F-95°F) during use. Do not subject the unit to shock or vibration. Do not move the unit while it is in use.
- A rapid increase in room temperature in cool weather can cause condensation to form inside the unit. If this happens, wait at least 15 minutes after turning the unit on before attempting to operate it. Failure to do so may result in paper jams and/or poor print quality.
- When cleaning the cover or operation panel of the unit, wipe gently using a damp cloth to which a small amount of a neutral detergent has been added. **NEVER USE SOLVENTS OR CHEMICALLY TREATED CLOTHS.**

# Introduction

Thank you for purchasing the SFX-107. This facsimile transceiver has many outstanding features, including:

## Fax features

- 5-page automatic document feed
- 3 resolution modes (fine/superfine/standard)
- 16-shade halftone
- Timer transmission
- Polling reception
- Overseas transmission mode
- Automatic redial
- Accept/refuse selective reception
- 30-meter roll of recording paper
- Compatible with plain-paper quality thermal paper

## Phone/Dialing Features

- 30-number automatic dialing memory
- Dial Bank to store the 20 most frequently called numbers
- Answering System connection ready
- Automatic switching between telephone, fax and answering system
- LCD display with 16-character line
- Built-in telephone handset

In order to use the SFX-107 effectively and keep it in good working order, read this instruction manual thoroughly and keep it for future reference.

# Table of contents

<b>Before use</b>	
Unpacking and accessories .....	5
Part names and functions .....	6
Operation panel .....	8
Installation .....	10
Telephone line and AC power connections .....	10
Dialing mode .....	11
Recording paper .....	12
Copying (Confirming proper operation) .....	14
<b>Phone use</b>	
Phone calls .....	15
Hold .....	16
Redial .....	17
One-touch dial .....	18
Speed dial .....	19
Dial Bank .....	20
<b>Fax use</b>	
Original documents .....	21
Transmission.....	22
Placing original documents .....	22
Contrast/Resolution .....	23
Manual transmission .....	24
Automatic transmission .....	25
Redial .....	26
Overseas transmission .....	27
Timer transmission .....	28
Reception .....	30
Auto reception mode .....	31
Manual reception mode .....	33
Answer reception mode .....	34
Remote reception .....	35
Polling reception .....	36
Selective reception.....	37
Phone reservation .....	39
Diagnostic reports .....	40
<b>Duplex ringing</b> .....	41

## Programming Functions

Entering names .....	42
Programming dialing memory .....	44
One-touch dial programming .....	44
Speed-dial programming .....	46
Printing a number list .....	49
Dial Bank editing .....	50
Calendar and clock .....	52
Header print (Setting your station name and fax number) .....	53
Activity report .....	55
Feature switches .....	57
Feature switch list .....	59
Printing a feature switch list .....	61
<b>Maintenance</b>	
Thermal paper handling .....	62
Jammed original .....	63
Mechanical error .....	64
Cleaning .....	65
Troubleshooting .....	67
<b>Specifications</b> .....	69

## Unpacking and accessories

### To unpack the SFX-107:

1. Remove the accessories (handset, recording paper roll, etc.) from carton.
2. Remove the fax machine along with the foam braces on both sides.
3. Remove the plastic wrapping around the fax machine.
4. Remove the transportation tapes.
5. Save the carton and the foam braces for later storage and/or shipping.
6. Place the unit where there is access to an AC outlet and a modular phone jack.  
(Be sure to observe the precautions found on page 1.)

### Accessories

Make sure the accessories listed below are included with the unit.

#### Accessories (included with machine)

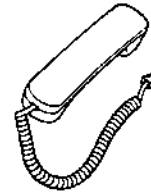

- Handset
- Instruction manual

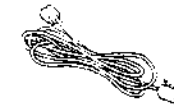

- Telephone line cord

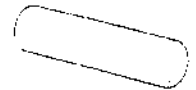

- Thermal paper

# Part names and functions

## Front view

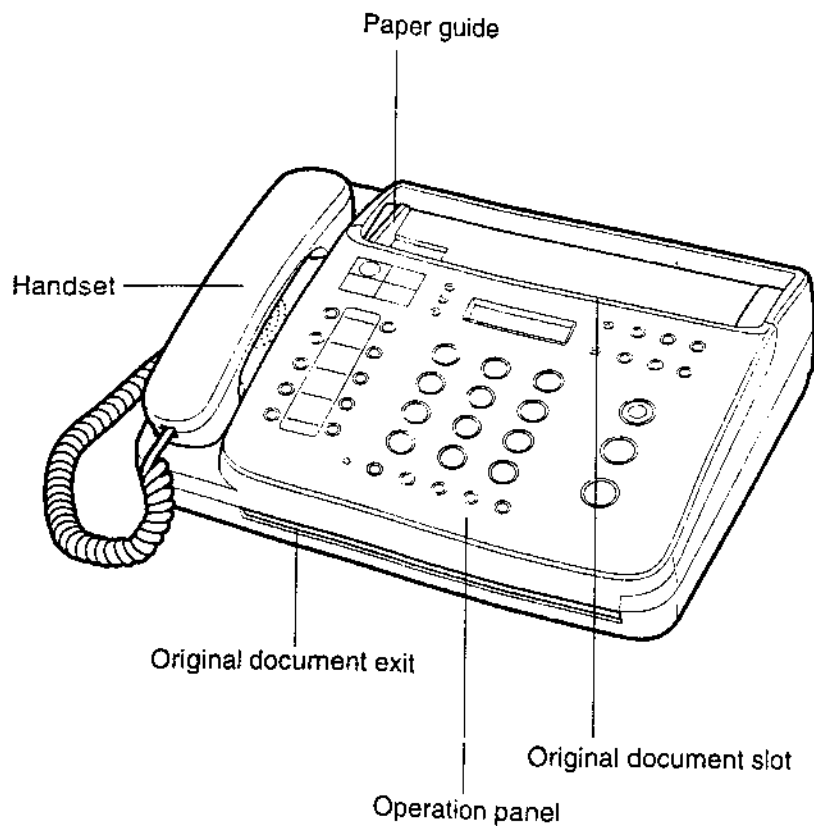

## Rear view and left side

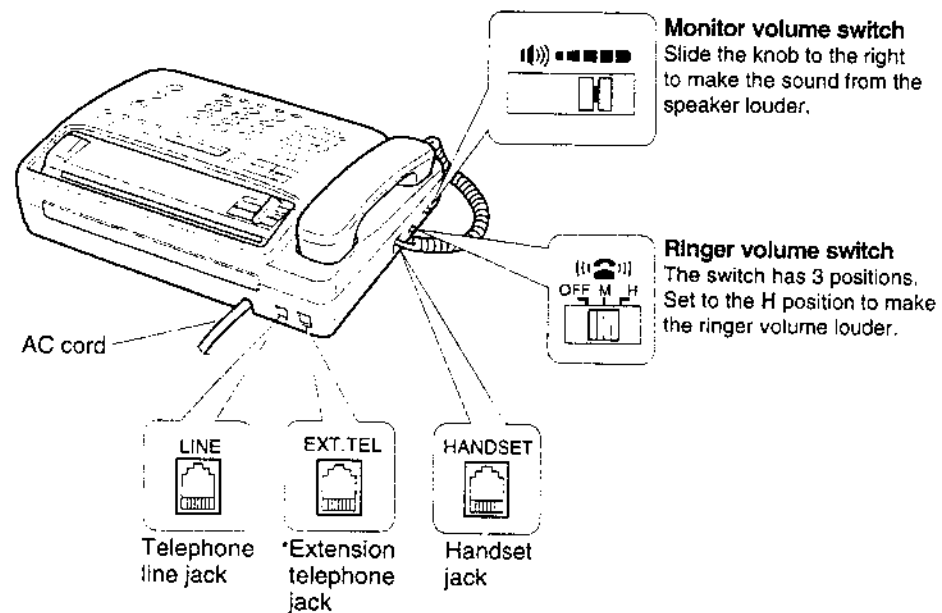

\* An extension phone or an answering machine can be connected to the EXT.TEL jack on the back of the unit.

## Inner view

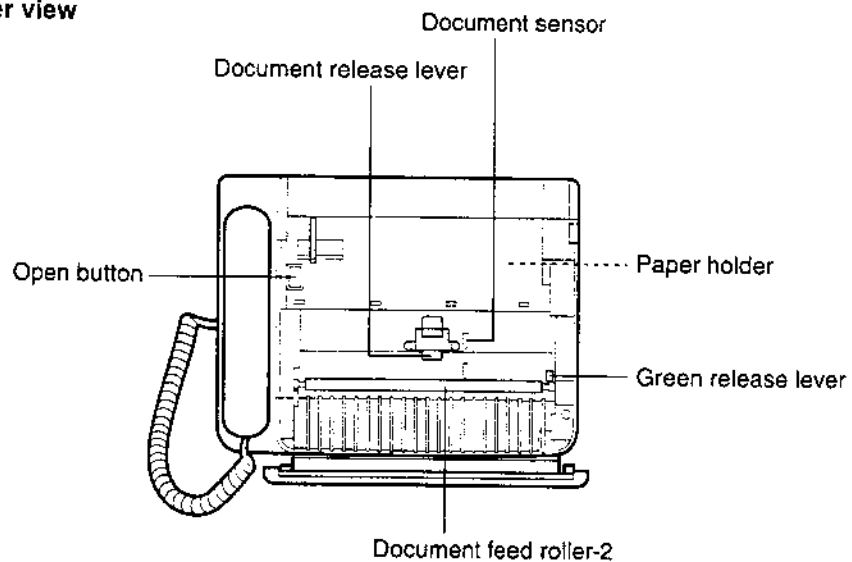

Before use

# Operation panel

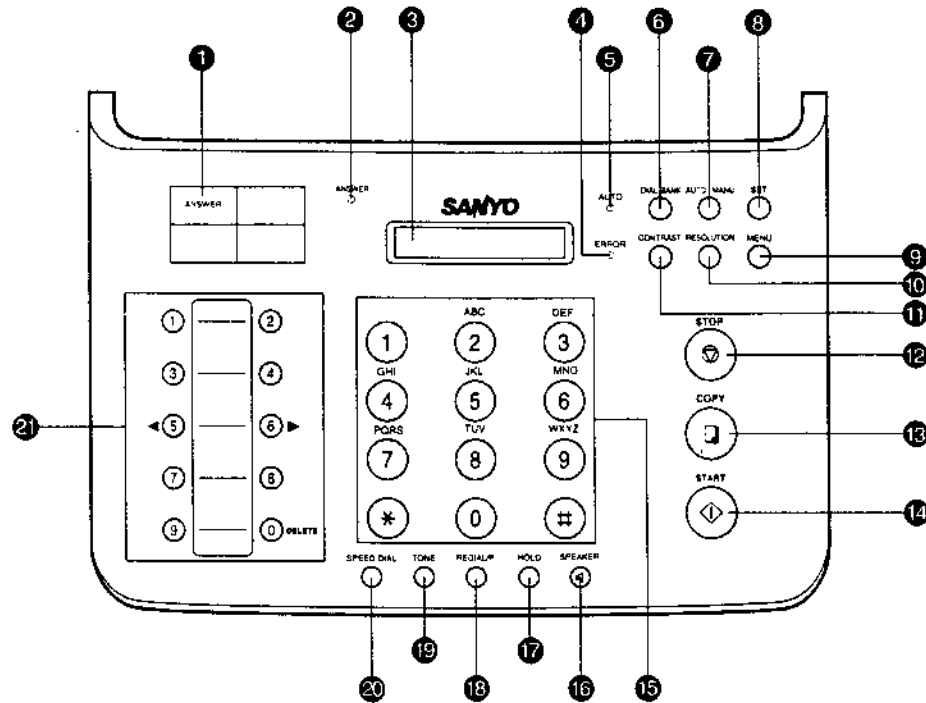

1. <b>[ANSWER]</b> key	• Press this key to set reception mode to ANSWER.
2. ANSWER lamp	• Lights when the unit sets to ANSWER mode.
3. Display	• Shows calendar and clock functions, operation guidance, machine status, etc.
4. ERROR lamp	• Lights if a communication error occurs.
5. AUTO lamp	• Lights when the unit sets to AUTO mode.
6. <b>[DIAL BANK]</b> key	• Press this key to dial the number stored in dial bank memory.
7. <b>[AUTO/MANU]</b> key	• Press this key to select a reception mode AUTO or MANUAL.

8. <b>[SET]</b> key	• Press this key to confirm selections.
9. <b>[MENU]</b> key	• Press this key when selecting various functions.
10. <b>[RESOLUTION]</b> key	• Press this key to select resolution settings.
11. <b>[CONTRAST]</b> key	• Press this key to select contrast settings.
12. <b>[STOP]</b> key	<ul style="list-style-type: none"> <li>• Press to interrupt transmission/reception/copying or to stop the ERROR lamp lighting.</li> <li>• Press to cancel various setting and dialing functions and to remove an original document that has been placed in the unit.</li> </ul>
13. <b>[COPY]</b> key	• Press this key to make a copy.
14. <b>[START]</b> key	• Press to start transmission or manual reception.
15. Number keys 0-9, #, *	• These keys are used to dial fax and phone numbers and to change various functions.
16. <b>[🔊]</b> (Speaker key)	• Allows you to monitor a call without using the handset.
17. <b>[HOLD]</b> key	• Temporarily places a call on hold.
18. <b>[REDIAL/P]</b> key	<ul style="list-style-type: none"> <li>• Press this key to redial the last number dialed.</li> <li>• Press this key to insert a pause between two digits in a number being dialed.</li> </ul>
19. <b>[TONE]</b> key	• Press this key to switch from pulse dialing to Touch-Tone dialing.
20. <b>[SPEED DIAL]</b> key	• Press this key when using speed dial.
21. One-touch keys	<ul style="list-style-type: none"> <li>• Frequently dialed numbers can be stored in memory using these 10 keys.</li> <li>• Also used in programming.</li> <li>[5]: ◀ (moves cursor 1 to the left.)</li> <li>[6]: ▶ (moves cursor 1 to the right. Also functions as ENTER key in name programming.)</li> <li>[0]: DELETE (functions as DELETE key.)</li> </ul>

# Telephone line and AC power connections

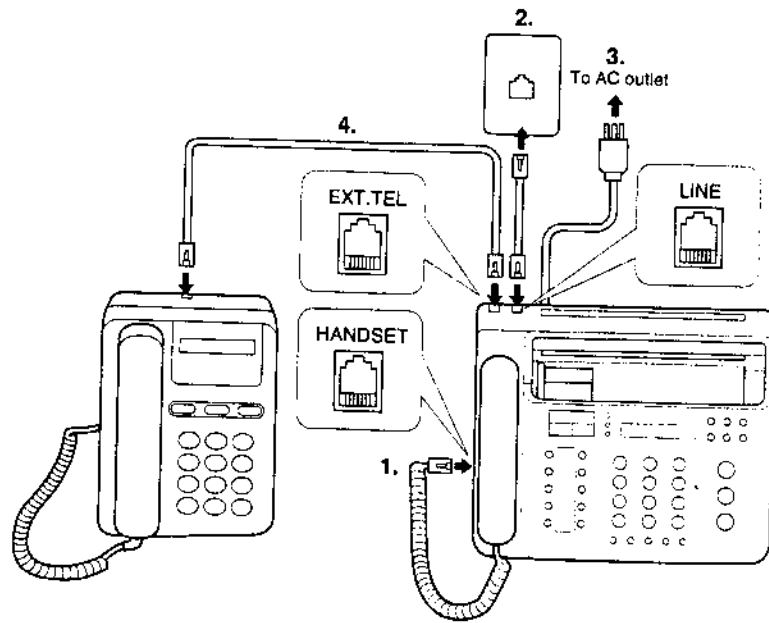

1. Connect the handset cord into the **HANDSET** jack.
2. Connect the telephone line to the **LINE** jack using the supplied line cord.
  - The SFX-107 should not share a modular jack with other communication equipment, as this may obstruct the proper functioning of the unit.
3. Connect AC power cord of the SFX-107 into an AC wall outlet.
  - The AC outlet shall be installed near the equipment and shall be easily accessible.
4. An extension telephone or an answering machine can be connected to the **EXT.TEL** jack.

**Note:**

- If you have custom calling services that produce tones or clicks during line use (such as Call Waiting), some difficulty may be experienced in the operation of your fax unit. Consult your telephone company.

**Caution:**

- Never install telephone wiring during a lightning storm.
- Never install telephone jacks in wet locations unless the jack is specifically designed for wet locations.
- Never touch uninsulated telephone wires or terminals unless the telephone line has been disconnected at the network.
- Use caution when installing or modifying telephone lines.
- Avoid using a telephone (other than a cordless type) during an electrical storm. There may be a remote risk of electric shock from lightning.
- Do not use the telephone to report a gas leak in the vicinity of the leak.

# Dialing mode

The SFX-107 has been factory-set to the PULSE dialing (10PPS) mode. If your telephone line uses TONE dialing, you must change the dialing mode setting using the feature switch No. 00.

Before use

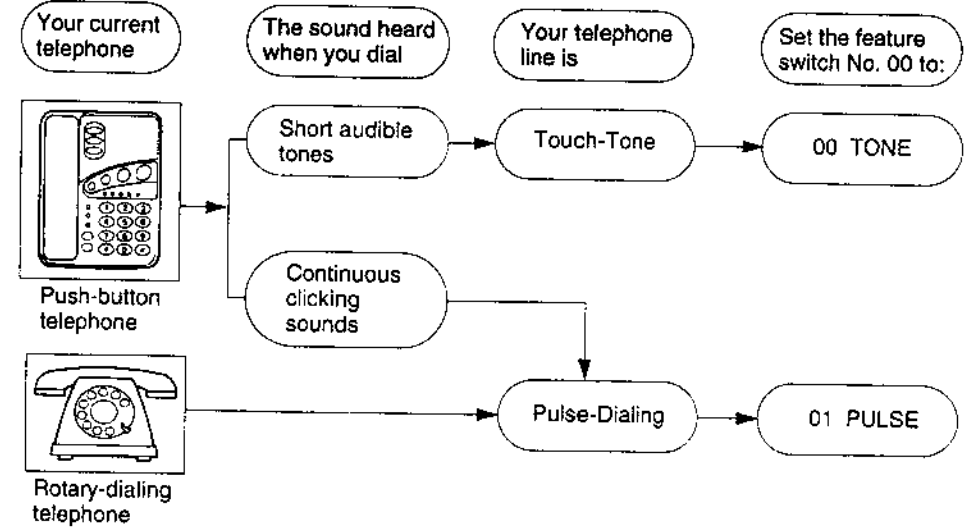

• If you are still not sure which dialing system your telephone line uses, contact your telephone company.

**To change dialing mode to TONE:**

- |                                                                                                                                                                                                                                                                      |                                                                                                                                                                                                                                                                                                                       |
|----------------------------------------------------------------------------------------------------------------------------------------------------------------------------------------------------------------------------------------------------------------------|-----------------------------------------------------------------------------------------------------------------------------------------------------------------------------------------------------------------------------------------------------------------------------------------------------------------------|
| <ol style="list-style-type: none"> <li>1. Press <b>[MENU]</b> 4 times.<br/>4: SET MODE ?</li> <li>2. Press <b>[SET]</b>.<br/>1: SET TIME ?</li> <li>3. Press <b>[MENU]</b> twice.<br/>3: FEATURE SW. ?</li> <li>4. Press <b>[SET]</b>.<br/>(00) DIAL MODE</li> </ol> | <ol style="list-style-type: none"> <li>5. Press <b>[SET]</b>.<br/>10PPS (00)</li> <li>6. Enter <b>[0]</b> and <b>[0]</b> to select the TONE mode.<br/>TONE (00)</li> <li>7. Press <b>[SET]</b>.<br/>(00) PAUSE TIME</li> <li>8. Press <b>[STOP]</b> twice to return to standby mode.<br/>26 Jun. '97 12:00</li> </ol> |
|----------------------------------------------------------------------------------------------------------------------------------------------------------------------------------------------------------------------------------------------------------------------|-----------------------------------------------------------------------------------------------------------------------------------------------------------------------------------------------------------------------------------------------------------------------------------------------------------------------|

# Recording paper

## How to install the recording paper roll:

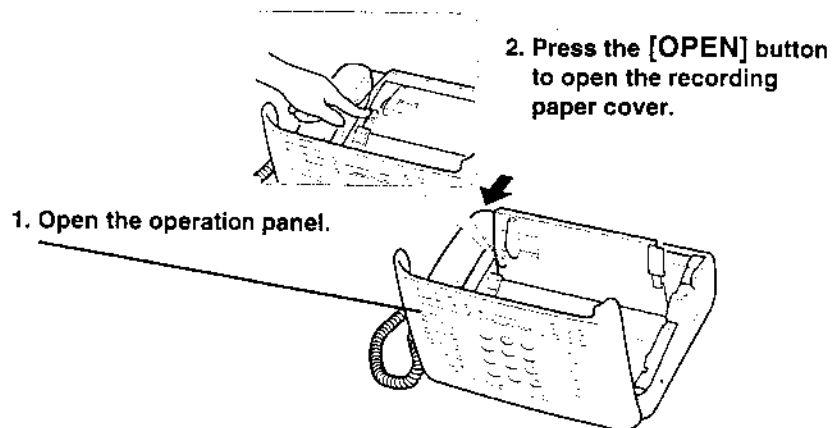

1. Open the operation panel.

2. Press the [OPEN] button to open the recording paper cover.

3. Insert the supplied roll of recording paper in the paper holder with both sides seated securely.

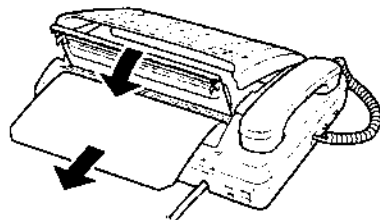
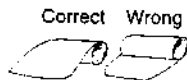

4. Pull out the end of the recording paper from the recording paper exit until extends 10cm (4").

5. Close the recording paper cover by pressing both left and right corners of the far end of the cover firmly.

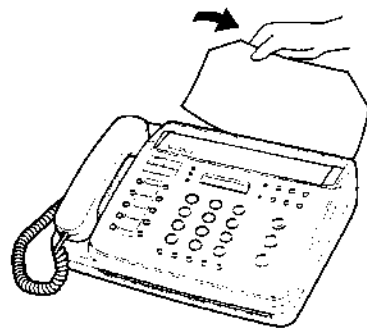

6. Cut the recording paper by tearing while lifting it.

• Use only the recording paper specified for the SFX-107.

### High-grade thermal paper

The SFX-107 is compatible with high-grade thermal paper, a new type of fax recording paper that has plain-paper quality. Unlike regular thermal paper, the high-grade thermal paper does not fade with time, can be written on with pencil and can be erased.

**SANYO Type: 3RE2182800450**, 216 mm (8.5") wide and 25 m (82') long.

### Thermal paper

**SANYO Type: R-4079448-1**, 216 mm (8.5") wide and 30 m (98') long.

To purchase, contact your dealer.



## Copying (Confirming proper operation)

Make a copy to confirm that the unit is operating properly.

1. Place the original document face down.

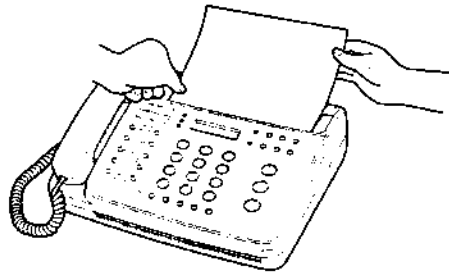

STD      NORMAL

2. Press [COPY].

\*\*\*      COPY      \*\*\*

3. After copying is completed, cut the recording paper.

26 Jun. '97 12:00

### • MEMO sheet

You can issue a blank sheet to write a memo.

Press [COPY] with no original inserted in the original document slot. The SFX-107 produces a blank memo sheet of about 10-cm (4") long. The MEMO sheet feature can also be used while the telephone is in use.

## Phone calls

### Making phone call (using the speaker key)

1. Press [ ] (speaker key) or lift the handset.

26 Jun. '97 12:00

2. Dial to the number you want to call.

**Example:** 1112222

- To dial a number, you can use any of the following dialing methods:

One-touch dial (page 18)

Speed dial (page 19)

Using Dial bank (page 20)

Using the [REDIAL/P] key (page 17)

Using the number keys

1112222

3. When the call is answered, lift the handset and talk.

### Answering a telephone call

1. The telephone rings.  
Lift the handset.
2. Hang up when the conversation is completed.

### Temporary Touch-Tone dialing access

Even if you have a pulse dialing line, you can temporarily change to Touch-Tone dialing to access special services such as electronic banking and remote-control answering machines.

1. Dial the number you want to call.
2. When your call is answered, press [TONE].
3. Enter the number required to access special services.
  - The SFX-107 stays in tone mode until the call ends. Then it returns automatically to pulse mode.

## Hold

---

1. Press [**HOLD**] during a telephone conversation.  
The call is put on hold.

\*\*\* HOLD \*\*\*

2. If you are using handset, you can replace it.
3. Press [**HOLD**] or lift the handset to continue the conversation.

- 
- An extension phone user cannot talk with the caller while a call is on hold.
  - The SFX-107 has been factory-set with a music-on-hold feature (The music is Greensleeves). Use the feature switch No. 10 to turn off this feature (no music while a call is on hold). See pages 57-59 for detailed instructions.

## Redial

---

The [**REDIAL/P**] key redials the last number dialed.

1. Press [ ] (or lift the handset).

26 Jun. '97 12:00

2. Press [**REDIAL/P**].  
→ The last number dialed is redialed.

123

3. When the call is answered, lift the handset and talk.

## One-touch dial

This feature allows you to dial a stored number at the touch of a single key. Before one-touch dialing can be used, the phone numbers of the parties must be programmed into memory. A maximum of 10 one-touch dialing numbers can be stored in memory. (See pages 44-45 for programming instructions.)

### To place a call using one-touch dialing buttons:

1. Press [  ] (or lift the handset).

26 Jun. '97 12:00

2. Press the one-touch key (0-9) for the party you want to call.

➔ The phone number programmed in the one-touch dialing memory is dialed out. The programmed name appears on the display.

DEALER A

3. When the call is answered, lift the handset and talk.

26 Jun. '97 12:00

## Speed dial

This feature allows you to place a call without dialing the entire number. Before speed dialing can be used, the phone numbers of the parties must be programmed into memory. A maximum of 20 speed-dialing numbers can be stored in memory. (See pages 46-47 for programming instructions.)

### To place a call using speed dialing:

1. Press [  ] (or lift the handset).

26 Jun. '97 12:00

2. Press [SPEED DIAL].

S. D : ■

3. Enter the speed-dialing number (01-20) for the number you want to call.

DEALER A

The programmed phone number is dialed out, and the programmed name appears on the display.

4. When the call is answered, lift the handset and talk.

26 Jun. '97 12:00

## Dial Bank

1. Press [ ] (or lift the handset).

26 Jun. '97 12:00

2. Press [DIAL BANK].

- A number stored in the Dial Bank appears on the display.

112233

3. Press [DIAL BANK] again to scroll down the number list.

- Numbers are shown starting from the most frequently called one.

112233

4. Press [START] when the desired number is displayed.

- ➔ The SFX-107 dials the number.

26 Jun. '97 12:00

- Numbers dialed using the one-touch or speed dialing will not be stored in the Dial bank.

### Editing numbers in the Dial Bank

- Stored numbers in the Dial Bank can be edited to add a name. See pages 50-51.
- When the name of a receiving party appears on your display when you send a fax, the name and the number you dialed will be stored in the Dial Bank.
- A maximum of 16 characters or 32 digits can be stored in each Dial Bank number.

## Original documents

### ■ Transmittable original size

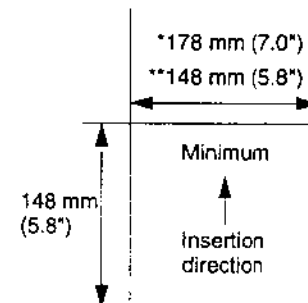
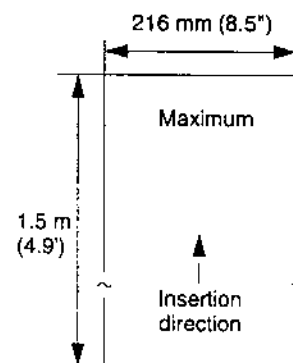

\*: multi-page documents  
\*\*: single-page document

### ■ Effective text width

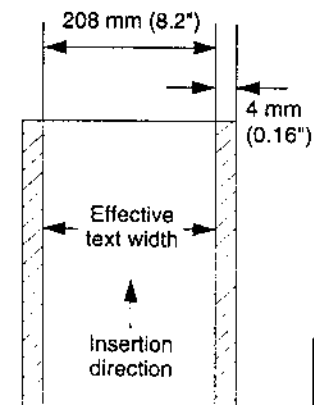

**Note:** If an original document is larger or smaller than the sizes specified above, it should be reduced or enlarged by a photocopier, and the copy can be used as an original document.

### ■ Effective thickness

	1 original sheet	multiple sheets
thickness (per sheet)	0.05 - 0.15 mm (0.002" - 0.006")	0.08 - 0.13 mm (0.003" - 0.005")

#### Notes on the suitability of documents:

- Allow ink and/or glue to dry completely before inserting a document.
- Do not transmit curled or folded documents.
- Make sure that any paper clips, staples or pins have been removed from documents.
- When an original is carbon paper, waxed paper or vinyl-coated paper, use a photocopy of the original.
- Never use documents thicker than 0.15 mm(0.006"), metal sheets or cloth. Use a photocopy instead.

## Placing original documents

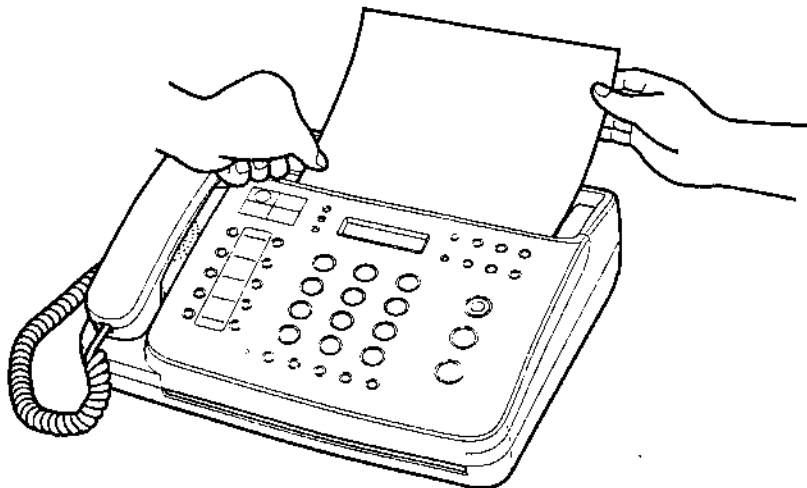

1. Adjust the paper guide to the width of the document.
2. Place the document face down between the guides and gently insert it in the original slot. The document advances slightly.

### When transmitting multiple-page documents:

Stack the sheets with the front edges of all sheets aligned straight.

### Note:

- Up to 5 sheets can be placed in the original document tray at one time. When transmitting more than 5 sheets, place the first 5 and then add more during transmission.

## Contrast/Resolution

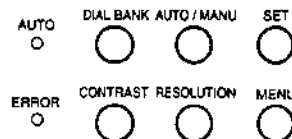

The SFX-107 allows you to select different contrast/halftone and resolution modes for fax transmission and copying. Select the most suitable mode for your original document after placing in the original tray. You can also set the SFX-107 either to remain in the selected mode until another selection is made, or to return to the default mode after each transmission/copying. Use the feature switches No. 27 and 28 to switch between **Not return** and **Return home** modes. The initial factory setting is in the **Not return** position. (See pages 57-58 and 60.)

1. Place the original document in the original document tray. The first page advances slightly, and the display changes to:

STD      NORMAL

This indicates that the unit is currently set to standard resolution (STD) and normal contrast (NORMAL) mode.

2. Press the [CONTRAST] and [RESOLUTION] keys 1 to 3 times to select the desired mode.

### [CONTRAST]

NORMAL

For normal contrast documents.



LIGHT

For low contrast documents which need to be transmitted or copied darker.



HALFTONE

For transmitting or copying halftone documents. (photographs, for example).

When HALFTONE is selected, the resolution mode is automatically set to FINE.

### [RESOLUTION]

STD

For text in standard typefaces.



FINE

For text with fine type and for drawings.



SUPERFINE

For text with very small characters and/or graphics.

The superfine communication mode is possible only with Sanyo fax models with the superfine feature and with non-Sanyo models that have international standard (ITU-T) superfine feature.

## Manual transmission

Manual transmission is like placing a call and then sending a fax. When your call is answered by a fax tone, the SFX-107 automatically starts fax transmission. Using the handset, you can monitor the line activity.

1. Place the original document face down.  
Adjust the paper guide to the width of the document.

STD NORMAL

2. Select a contrast/resolution mode if necessary. (See page 23.)

STD NORMAL

3. Lift the handset (or press **speaker** key).

4. Dial the number.  
**Example:** 1112222

1 1 1 2 2 2 2

You can also use one of the following dialing methods:

### One-touch dialing

Press a one-touch key (0-9). Programming is required in advance. See pages 44-45.

### Speed dialing

Press **[SPEED DIAL]** and enter the speed dial number (01-20). Programming is required in advance. See pages 46-47.

### Dial Bank dialing

Press **[DIAL BANK]** to select a number from the 20 most frequently dialed number list stored in Dial Bank. Then press **[START]**. See page 20.

### Direct dialing

Dial the number using the number keys.

5. When the SFX-107 detects a fax tone sent by the receiving unit, transmission begins automatically.  
➔ The name/number of the receiving party appears on your display if their fax machine has a station ID programmed.

Allison McNab

6. Replace the handset.

- If a person answers your fax call at step 5, you can send a fax by pressing **[START]** after the conversation.
- Press **[STOP]** to interrupt a transmission or to remove a document set for transmission.
- If you make a mistake when entering a number, replace the handset and lift it again (or press **speaker** key twice), then enter the correct number.
- The feature switch No. 54 must be set to the ON (01) position for auto progress transmission to take place at step 5. (This feature is factory-set to ON) See page 60.  
If it is set to the OFF (00) position, the **[START]** key has to be pressed to initiate transmission.

## Automatic transmission

You can send a fax without using the handset or speaker key. This is called "automatic transmission" since your unit automatically sends a fax signal to the party if you do not use the handset or speaker key.

1. Place the original document face down.  
Adjust the paper guide to the width of the document.

STD NORMAL

2. Select a contrast/resolution mode if necessary. (See page 23.)

STD NORMAL

3. Dial the number.

**Example :** 123456

1 2 3 4 5 6

You can use one of the following dialing methods:

### One-touch dialing

Press a one-touch key (0-9). Programming is required in advance. See pages 44-45.

### Speed dialing

Press **[SPEED DIAL]** and enter the speed dial number (01-20). Programming is required in advance. See pages 46-47.

### Dial Bank dialing

Press **[DIAL BANK]** to select a number from the 20 most frequently dialed number list stored in Dial Bank. Then press **[START]**. See page 20.

### Direct dialing

Dial the number using the number keys and press **[START]**.

4. When the line is connected, transmission begins automatically.  
➔ The name/number of the receiving party appears on your display if their fax machine has a station ID programmed.

Allison McNab

- If the line is busy or there is no answer, the unit automatically redials the number 2 times. (See page 26.)
- Press **[STOP]** to interrupt a transmission or to remove a document set for transmission.
- If you make a mistake when dialing a number, press **[STOP]**, then enter the correct number.

## Redial

### Automatic redial

When an automatic fax transmission attempt fails due to a busy phone line (no answer), the SFX-107 automatically redials the number 2 more times.

Display shows:

WAITING REDIAL

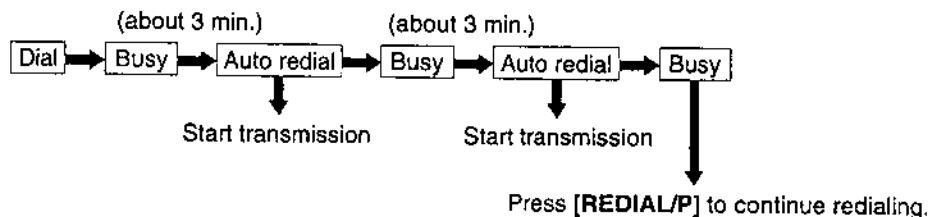

- If the document has been removed, automatic redialing is canceled.
- The SFX-107 is set to redial a number twice (three times for a number dialed using the timer transmission) at three minute intervals. These settings can be changed using the features switches No. 05 and No. 06. (See pages 57-59.)

### Manual redial

1. Press **[REDIAL/P]**.  
The number is redialed.

## Overseas transmission

When you transmit a fax to an overseas party, poor telephone line connection may cause a transmission error to occur. The overseas transmission feature may be used to reduce communication errors with overseas parties.

1. Place the original document face down.  
Adjust the paper guide to the width of the document.

STD NORMAL

2. Select a contrast/resolution mode if necessary. (See page 23.)

STD NORMAL

3. Press **[SPEED DIAL]**.

S. D : ■

4. Press **[#]**.  
→ A beep sounds.

OVERSEAS Tx. SET

5. Enter the overseas access code.  
**Example:** 011

011

6. Press **[REDIAL/P]** to enter a 3-second\* pause.

011;

7. Dial the country code and fax number.  
**Example:** 49111222333

011;49111222333

8. Press **[START]**.  
→ When the line is connected, transmission begins automatically.

011;49111222333

- A pause time is initially set to 3 seconds. This can be changed between 2 to 12 seconds using the feature switch No. 01. See pages 57-59.
- The overseas transmission feature may also be used for local communications when a transmission error occurs.

## Timer transmission

The SFX-107 can be programmed for delayed fax transmission. The delayed start time can be set up to 24 hours in advance. A maximum of 5 pages can be sent to one destination using the timer feature.

1. Place the original document face down.

Adjust the paper guide to the width of the document.

STD      NORMAL

2. Select a contrast/resolution mode if necessary. (See page 23.)

STD      NORMAL

3. Press [MENU] 3 times.

3 : TIMER Tx. ?

4. Press [SET].

START TIME : ■

5. Enter a delayed start time using the number keys.  
(The start time must be entered using the 24-hour system.)  
**Example:** 13:30

START TIME 13:30

6. Press [SET].

PARTY ?

7. Enter the fax number.  
You can use one-touch dial, speed dial or number keys.  
**Example:** One-touch dial 1.

Alison McNab

8. Press [SET].  
→ A beep sounds.

<TIMER Tx. 13:30>

- Press [STOP] to interrupt a transmission or to remove a document set for transmission.
- If you make a mistake when entering start time at step 5, press [DELETE] then enter the correct time.
- If you make a mistake when entering the number at step 7, press [STOP], then enter the correct number.

### Canceling timer transmission

To cancel a programmed timer transmission:

1. Press [MENU] 3 times.
2. Press [SET].  
→ The display shows "CANCEL ?".
3. Press [SET].  
→ A beep sounds.  
• To remove inserted documents, press [STOP].

### Changing programmed timer transmission

1. Press [MENU] 3 times.
2. Press [SET].  
→ The display shows "CANCEL ?".
3. Press [MENU] to select "CHANGE ?".  
→ The display shows "CHANGE ?"
4. Press [SET].
5. Press [DELETE] to clear the wrong start time.
6. Enter a correct delayed start time.
7. Press [SET].
8. Press [STOP] to delete the wrong number.
9. Enter a correct fax number.
10. Press [SET].  
→ A beep sounds.

### Timer transmission report

Using the feature switch No.32, you can program the SFX-107 to automatically issue a timer transmission report (See pages 57-58 and 59):

00	OFF (No report issued)
01	ON (after each timer transmission)
02	ON (when an error occurs)

- The switch is initially factory-set to the OFF (no report) position.
- If a fax number is busy when a timer transmission is attempted, the number is automatically redialed three times.

The number of redials can be changed using the feature switch No. 05. (See pages 57-59.)



# Reception

## Selecting the reception modes

The SFX-107 provides three reception modes: AUTO, MANUAL and ANSWER.

The [AUTO/MANU] key switches between AUTO and MANUAL modes. The AUTO lamp lights when AUTO mode is selected.

To set to ANSWER mode, press the [ANSWER] key. The ANSWER lamp lights. Once ANSWER mode is turned on, this overrides the setting of the AUTO/MANUAL key.

Press [ANSWER] again to turn off the ANSWER mode. The unit returns to the mode previously selected.

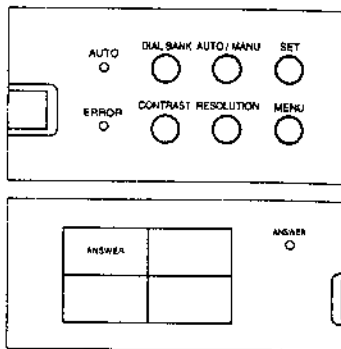

### AUTO mode

Receiving faxes is automatic in AUTO mode. No operation is required on the SFX-107 or an extension telephone connected to the EXT.TEL jack on the back of the unit to receive faxes.

Select this mode when you have a dedicated fax line. Ring delay resetting may be desirable.

With the user-selectable ring delay feature, the AUTO mode is suitable for single line users who receive both fax and voice calls on the same number.

#### Ring delay in AUTO mode

When the unit is in the AUTO mode, the SFX-107 rings 3 times\* before it connects to the line.

And, if the call is not answered, it issues certain simulated rings\* after the line is connected.

\*Both first and second sets of ring counts are user-selectable.

#### Notice to Hong Kong users

Default setting of the simulated rings is no rings. As soon as the line is connected, the SFX-107 answers the call with fax tone.

See the next 2 pages for more details on the AUTO reception mode.

### MANUAL mode

Select this mode if you use the SFX-107 mainly for fax transmission, and wish to receive faxes with your control only. Incoming faxes can be received only after you answer the call.

### ANSWER mode

Select this mode when you want the SFX-107 to automatically receive both fax and voice messages while you are away.

All voice calls are directed to the connected telephone answering machine.

See page 34 for more details.

# Auto reception mode

## AUTO reception operation sequence

1. When a call arrives, the SFX-107 connects to the line after it rings 3 times\*.  
(\*User-selectable ring delay. See **IMPORTANT** below.)

➔ From this moment, callers will be charged for the phone call.

2A. The call is an automatic fax transmission:

The SFX-107 detects incoming fax signals and begins receiving fax.

\*\* RECEIVING \*\*

2B. The call is a voice call or manual fax transmission:

The SFX-107 switches to fax reception mode according to the ring delay setting of feature switch No. 09\*\*.  
(\*\*User-selectable. See **IMPORTANT** below.)

### IMPORTANT

When you select AUTO mode, you may wish to change the ring delay settings to best suit your fax and telephone use — whether you have a dedicated fax number or you use a single line for both fax and voice calls. Use the feature switches No.07 and No.09.

\* **Feature switch No. 07** (first set of rings) can be set to a short ring or regular rings. Default setting is 3 rings.

\*\* **Feature switch No. 09** (second set of rings) can be set to no rings or 3-11 rings. Default setting is no rings.

See pages 57-59 for feature switch resetting procedures.

### FAX/TEL use

If you use a single line for both fax and telephone use, it is recommended to change the second ring counts (Feature switch No. 09) to 3-11 rings (code # 01-05).

### FAX only use

If you have a dedicated fax line, it is recommended to change the first ring counts (Feature switch No. 07) to one short ring (code # 00).

## Manual reception mode

When set in MANUAL mode, the SFX-107 rings just like a telephone. When a call arrives, the unit and an extension telephone connected ring until you answer the call using one of them. Incoming faxes can be received with your initiation only.

1. Lift the handset when the telephone rings.

2A. The call is a voice call:  
Talk.

3A. If caller wants to send a fax after the conversation is complete, press [START]. Your caller can send a fax after hearing a fax tone.

2B. The call is an incoming fax :  
You hear an incoming fax tone. The SFX-107 receives the incoming fax automatically\*.

\*You may need to press the [START] key to initiate fax reception, if you have a noisy line or if the feature switch No. 54 has been turned OFF(00). The switch is initially factory-set to ON(01).

3B. Replace the handset.

\*\* RECEIVING \*\*

4B. When reception is complete, the display shows date and time.

26 Jun. '97 12:00

### What to do if you answer a fax call before the SFX-107 connect to the line.

- If you use the handset of SFX-107, fax reception starts automatically. Replace the handset.
- If you pick up the call from an extension telephone connected to the SFX-107, press [3] and then [3] firmly on the extension phone to activate fax reception.

See **Remote reception** on page 35.

Remote reception activation number can be changed to any 2-digit number from 10 to 99.

(The default setting of the remote reception number is set to [3], [3] by feature switch No. 08)

- Pressing the [START] key on the SFX-107 will always initiate fax reception.

### If you answer a fax call on an extension phone:

- If you pick up the call from an extension phone connected to the SFX-107, press [3] twice firmly on the extension phone to activate fax reception.

See **Remote reception** on page 35.

## Answer reception mode

Use this mode if you want to receive both phone messages and faxes while you are away. (Connect an answering machine to the EXT.TEL jack on the back of the unit.)

### When a call arrives:

1. The SFX-107 (and an extension telephone connected) rings according to the ring delay setting of your answering machine.
2. The line connects and your answering machine answers the call with your greeting.

**3A. The call is an incoming fax (by automatic transmission):**  
The SFX-107 automatically receives the fax after your greeting is played.

**\*\* RECEIVING \*\***

**3B. The call is a phone call (or a manual fax call):**

Your answering machine starts recording after the beep following your greeting. Callers can now leave a message.

Advise your callers, in your greeting, that a fax can be received during or after the greeting.

**Example: If you are sending a fax, start transmission now. Or please leave a voice message after the tone.**

- ➔ If no voice is heard for 6 seconds after the beep following your greeting, the SFX-107 automatically switches over to the fax receiving mode and sends a fax tone to the caller.
- ➔ The answering machine must be set to answer a call within 4 rings.
- ➔ When the SFX-107 is set to ANSWER mode, there may be some difficulties in remote message retrieval operation of the connected answering machine. If you need to access the answering machine by remote, the SFX-107 must be set to MANUAL mode.

## Remote reception

The remote reception feature allows a fax reception after a telephone call is answered by an extension telephone connected to the SFX-107.

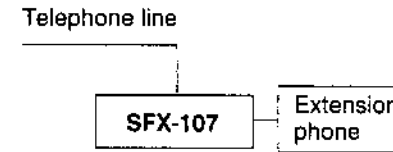

The feature switch No. 08 (Remote receiving) must be set to ON. (The initial factory setting is ON).

1. When an incoming call is received, lift the handset of the extension phone.
2. Talk if it is a voice call. If it is a fax, then:
3. Enter **[3]** twice on the extension phone to activate a fax reception.
4. Replace the handset.

- **Remote reception activation number** is initially set to 33. To change this number, use the feature switch No. 08. (See pages 57-59.)

### Notes:

- For SFX-107, remote reception does not work when the reception mode is set to ANSWER mode.
- Remote reception may not function properly on certain telephones.

## Polling reception

The polling reception feature allows you to call another party and instruct the other party's machine to transmit a document to your number. (The other party's fax machine must be set to polling transmission mode.)

The cost of the call is billed to the receiving party.

1. Press [MENU] once.

1: POLLING Rx. ?

2. Press [SET].

PARTY ?

3. Dial the other party's fax number.

**Example:** 1112222

You can use one-touch, speed dial or number keys.

1 1 1 2 2 2 2 ■

4. Press [SET].

➔ The unit begins dialing.

• When the line is connected, reception begins automatically.

1 1 1 2 2 2 2

• Press [STOP] to interrupt a reception.

**Note:**

• The other fax machine must be using international standard (ITU-T) polling.

## Selective reception

This feature allows you to restrict reception to certain parties. Using the feature switch No. 26, you can select either ACCEPT mode, REFUSE mode or OFF. (The initial factory-set position is OFF.) See page 60.

### Accept

Reception is possible only when the other party's fax number is programmed in the one-touch or speed dial memory of your SFX-107.

- If a fax arrives from other numbers than those programmed in the memory of your unit, the SFX-107 will disconnect from the line after the display shows RECEIVING.
- If a party's fax machine does not have a station identification feature or the station number has not been programmed in their fax machine, no faxes will be received from this number (even if the number is programmed in your unit.)

### Refuse

The SFX-107 allows you to create a Refuse list and store up to 20 fax numbers in its memory. The SFX-107 will not receive faxes sent from the parties whose numbers are programmed in the Refuse list.

- The Refuse feature checks the last 4 digits of a number.
- When the Refuse mode is selected, the SFX-107 will not receive faxes from any party whose unit has no station identification feature or whose station number is not programmed in their unit.

### Programming the Refuse list

1. Press [MENU] 4 times.

4: SET MODE ?

2. Press [SET].

1: SET TIME ?

3. Press [MENU] 4 times.

5: REFUSE LIST ?

4. Press [SET].

1: SET 2: DELETE

5. Press [SET].

(01) ■ : SET

6. Press **[MENU]** to select a Refuse list number from 01 to 20.  
• The number display scrolls one at a time as you press **[MENU]**.

(01) ■ :SET

7. Enter the last 4 digits of the number you want to refuse.  
**Example:**1234

(01) 1234 :SET

8. Press **[SET]**.  
➔ A beep sounds.  
• To program other numbers, repeat steps 6-8.

(01) 1234 :SET

9. Press **[STOP]** twice to return to stand-by mode.

26 Jun. '97 12:00

- If you make a mistake when entering the number, press **[DELETE]** and then re-enter the correct number.
- When a caller whose name is programmed in your Refuse list calls you, the SFX-107 rings and you can talk to the caller.
- To turn off selective reception feature, change the feature switch No. 26 setting to OFF.

#### To change a number programmed in the Refuse list:

1. Operate steps 1-5 above.
2. Press **[MENU]** to select the Refuse list number you want to change.
3. Press **[DELETE]**.
4. Enter the new 4 digits.
5. Press **[SET]**.  
➔ A beep sounds.
6. Press **[STOP]** twice.

#### To delete a number programmed in the Refuse list:

1. Operate steps 1-4 of the programming procedure.
2. Press **[MENU]** to select "2:DELETE".
3. Press **[SET]**.
4. Press **[MENU]** to select the Refuse list number you want to delete.
5. Press **[SET]**.  
➔ A beep sounds. Repeat steps 4-5.
6. Press **[STOP]** twice.

## Phone reservation

This feature allows you to start a phone conversation after sending or receiving a fax.

#### To start a phone conversation after sending a fax:

1. Lift the handset during fax transmission.
  - When the fax transmission is completed, a beep sounds at the other side for 7 seconds.
2. When the other party picks up the handset, you hear a beep. Talk to the other party.

#### To start a phone conversation after receiving a fax:

1. Lift the handset during fax reception.
  - When the reception is completed, a beep sounds at the other side for 14 seconds.
2. When the other party picks up the handset, you hear a beep. Talk to the other party.

- If you lift the handset and replace it, phone reservation is canceled.
- If the other party does not pick up the handset while the beep sounds, the phone line will be disconnected.
- If the other unit does not have phone reservation function, the phone line will be disconnected.

#### Phone reservation reception

If the other party initiates phone reservation, a beep sounds and the display shows **PHONE CALLING**. Lift the handset and talk to the calling party.

## Diagnostic reports

The codes shown below appear on the activity and timer transmission reports to help you diagnose any problems quickly and accurately.

ERROR CODE	DESCRIPTION
OK:	• Transmission/reception satisfactory.
10:	• No response from other party. Contact other party to make sure their machine is ready to receive. • Make sure the telephone line is connected to the <b>LINE</b> jack of the unit.
12:	• No response to timer transmission.
16:	• Mechanical error (See page 64).
20:	• <b>[STOP]</b> key pressed during transmission/reception.
21:	• Original document jammed. Remove and replace correctly.
23:	• Recording paper ran out during reception. Replace recording paper.
24:	• Recording paper jammed during reception. Check the recording paper.
25:	• Cutter did not work during reception. Contact an authorized Sanyo service center.
27:	• Timer transmission is canceled or no original inserted for timer transmission.
30:	• Printing quality poor due to poor telephone line connection. If this code appears frequently, contact an authorized Sanyo service center.
40:	• Other party's fax machine in abnormal condition (no recording paper, etc.) Contact the other party.
50:	• Transmission was halted by the other party. (Line was disconnected during transmission/reception.)
60:	• Communication impossible due to poor telephone line.
71:	• Communication impossible due to compatibility problems. Contact other party. Make sure the feature switch No. 26 is set to OFF.

## Duplex ringing

You can set the SFX-107 to duplex ringing by feature switch No.56. To change setting, see pages 57-58 and 60.

Initial factory setting of feature switch No.56 is OFF (No duplex ringing).

Set to ON when this service is applied by H.K telecom (application is required).

Once this mode is selected, the SFX-107 operates as follows.

In case of normal ring: No ring detection is carried out, only phone rings until the operator lifts the handset.

In case of Fax ring: The SFX-107 detects the ring after 2 rings and releases the Fax tone to the caller.

### Note

- Once duplex ring is set to ON, the SFX-107 operates according to the ring as described above, no matter what the reception mode is set.

# Entering names

Before programming the dialing memory or your station name, you need to know to enter names using number keys and one-touch keys. The number keys [2], [4], [5], [6], [8] and [0], the one-touch keys [5], [6] and [0] are used for name programming.

The characters are grouped as shown below:

Group 1	Group 2	Group 3
ABCDE	abcde	12345
FGHIJ	fghij	67890
KLMNO	klmno	. . . ; :
PQRST	pqrst	+ - / & *
UVWXY	uvwxy	# ' " ( )
Z	z	< > ! ? =

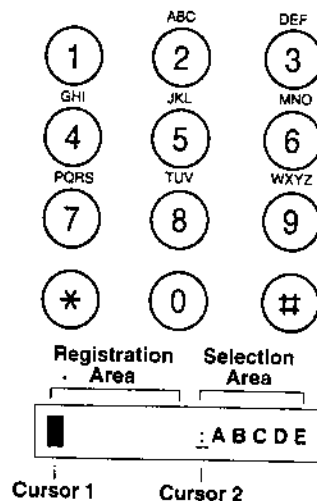
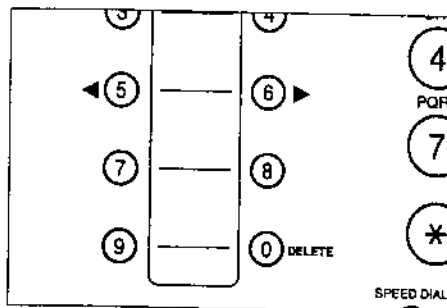

The LCD display is divided into 2 sections: The registration area (left) shows the name being entered, and in the selection area (right), a set of 5 characters appears as you scroll up or down the display. Each area has a separate cursor.

## Selecting a character

- Use number key [5] to select the desired character group.  
The first line of the selected group appears each time the number key [5] is pressed.
- Use number keys [2] or [8] to scroll up or down the display.
- Use number keys [4] or [6] to move the cursor 2 to select a character.
- Press [▶] (one-touch key 6) to enter the selected character into registration area.  
The cursor 1 moves to the right.
- Repeat steps 1 - 4 to finish writing a name.

- To leave a blank space in the name, press number key [0].
- To backspace the cursor 1, press [◀] (one-touch key 5).
- To advance the cursor 1 to the right, press [▶] (one-touch key 6).
- To erase a character, move the cursor 1 over the character to be erased, and then press the [DELETE] (one-touch key 0).

**Example:** To enter SFX 107

- To write S:  
Press [8] to scroll up the display and select PQRST.  
Press [6] to move the cursor 2 over the S.  
Press [▶] to enter S.  
The cursor 1 moves to the next position.

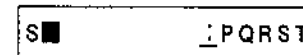

- To write F:  
Press [2] to scroll down the display and select FGHIJ.  
The cursor 2 is already on the F.  
Press [▶] to enter F.

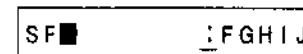

- To write X:  
Press [8] to scroll up the display and select UVWXY.  
Press [6] to move the cursor 2 over the X.  
Press [▶] to enter X.

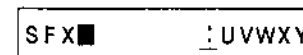

- To leave a space:  
Press [0].

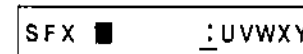

- To write 107:  
Press [5] to call up the group 3.

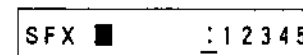

- Press [6] to select 1, and press [▶].  
Press [8] to scroll up the display and select 67890.  
Press [4] to select 0, and then press [▶].  
Press [6] to select 7, and press [▶].

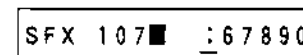

- To make a correction, move the cursor 1 over the wrong letter and delete it, and then write the right letter.
- If the procedure is interrupted for more than one minute, the display returns to standby mode. To restart, begin from step 1.

## Programming dialing memory

Up to 30 telephone or fax numbers (and corresponding names) can be stored in the memory. The fax/phone numbers stored to each of the 10 one-touch dialing keys (0-9) can be dialed out at the touch of a single key.

An additional 20 numbers can be stored using the speed-dialing numbers (01-20).

### One-touch dial number programming

1. Press [MENU] twice.

2 : O. T & S. D SET ?

2. Press [SET].

O. T No. = 1 ?

3. Press one-touch dialing key (0-9).

**Example:** To program a number in the one-touch key 2, press [one-touch key 2].

O. T No. = 2 ?

4. Press [SET].

█ : ABCDE

5. Enter the party's name (to a maximum of 16 characters).

See pages 42-43 for detailed instructions.

EDWARD █ : ABCDE

6. Press [SET].

█

7. Enter the fax (or telephone) number.

(A maximum of 32 digits can be entered including pauses and hyphens.)

**Example:** 1-222-3333

1-222-3333 █

8. Press [SET].

➔ A beep sounds.

• To program other one-touch numbers, repeat steps 3-8 above.

O. T No. = 3 ?

9. Press [STOP] to finish one-touch number programming.

26 Jun. '97 12:00

• For instructions on printing out a numerical list of programmed names and numbers, see page 49.

• To interrupt programming, press [STOP].

• To enter a hyphen (-), press [SPEED DIAL].

• To enter a three-second pause between two digits of a number, press [REDIAL/P] in the appropriate place. A semicolon (;) in the display indicates a pause.

• If you make a mistake in entering fax/phone number, position the cursor over the digit to be changed using the cursor keys [▶] key (one-touch key 6) or [◀] key (one-touch key 5), and press [DELETE] (one-touch key 0) to delete the digit. Then enter the correct digit.



### Speed-dial number programming

1. Press [MENU] twice.

2 : O. T & S. D SET ?

2. Press [SET].

O. T No. = 1 ?

3. Enter a speed-dial location number using the number keys.

**Example:** To store a fax number in the speed-dial location number 10, press [1] and then [0].

S. D No. = 10 ?

4. Press [SET].

█ :ABCDE

5. Enter the party's name (to a maximum of 16 characters).  
(See pages 42-43 for detailed instructions.)

EDWARD █ :ABCDE

6. Press [SET].

█

7. Enter the fax (telephone) number to be stored.

A maximum of 32 digits can be entered, including pauses and hyphens.

**Example:** 1-222-3333

1-222-3333 █

8. Press [SET].

➔ A beep sounds.

Repeat steps 3-8 to program other numbers.

S. D No. = 11 ?

9. Press [STOP] to finish speed-dial number programming.

26 Jun. '97 12:00

- For instructions on printing out a list of programmed names and numbers, see page 49.
- To interrupt programming, press [STOP].
- To enter a hyphen (-), press [SPEED DIAL].
- To enter a three-second pause between two digits of a number, press [REDIAL/P] in the appropriate place. A semicolon (;) in the display indicates a pause.
- If you make a mistake in entering fax/phone number, position the cursor over the digit to be changed using the cursor shift keys ([▶] and [◀]), and press [DELETE] key to delete the digit. Then enter the correct digit.

### Changing programmed one-touch dialing/speed dialing numbers

1. Press **[MENU]** twice.
2. Press **[SET]**.
3. Press the one-touch dialing key or enter the speed dialing location number of the number you want to change.

**Example:** To change the number and name programmed in the speed dial number 10, press **[1]** and then **[0]**.

4. Press **[SET]**.  
➔ The display shows "CHANGE".
5. Press **[SET]**.
6. Position the cursor over the character to be erased, press **[DELETE]**, and then enter the new name.  
(See "Entering names" on pages 42-43.)
7. Press **[SET]**.
8. Position the cursor over the digit to be erased, press **[DELETE]**, and then enter the new number.
9. Press **[SET]**.  
➔ A beep sounds.  
Repeat steps 3-9 to change other one-touch dialing/speed dialing numbers.
10. Press **[STOP]** to finish.

### Canceling programmed one-touch dialing/speed dialing numbers

1. Press **[MENU]** twice.
2. Press **[SET]**.
3. Press the one-touch dialing key or enter the speed dialing number of the number you want to cancel.  
**Example:** To cancel one-touch dialing number 2, press the one-touch key 2.
4. Press **[SET]**.
5. Press **[MENU]** to select "CANCEL".
6. Press **[SET]**.  
➔ A beep sounds.  
Repeat steps 3-6 to cancel other one-touch dialing/speed dialing numbers.
7. Press **[STOP]** to finish.

## Printing a number list

You can print a list of the programmed one-touch dialing and speed-dialing numbers.

### Printing one-touch dial/speed dial list

1. Press **[MENU]** twice.

2: O. T & S. D SET ?

2. Press **[COPY]**.

O. T & S. D LIST

3. After the list is printed, press **[STOP]** to return to standby mode.

26 Jun. '97 12:00

### Sample of one-touch dialing/speed dialing number list

*** ONETOUCH, SPEED DIAL LIST ***			
26 Jun. '97 12:00			
	No.	PARTY'S NAME	NUMBER
ONETOUCH DIAL	1	AAA	111222333
	2	BBB	444555666
	3	CCC	777888999
SPEED DIAL	01	DDD	111444666
	02	EEE	333222111
	03	FFF	555777999

## Dial Bank editing

You can edit the data stored in the Dial Bank — adding a name or erase a number. You can also transfer Dial Bank data to the one-touch or speed dial memory.

### Attaching a name

1. Press [MENU] 4 times.

4 : SET MODE ?

2. Press [SET].

1 : SET TIME ?

3. Press [MENU] 5 times.

6 : DIAL BANK ?

4. Press [SET].

➔ The first number in the Dial Bank appears.

1 1 1 2 2 2

5. Press [DIAL BANK] to select the number you want to add a name to.

1 1 1 3 3 3

6. Press [SET].

█ : ABCDE

7. Enter the name (to a maximum of 16 characters).

See pages 42-43 for detailed instructions.

- To transfer this name and number to one-touch dial or speed dial memory, proceed to step 6 of **Transferring to one-touch dial/speed dial** memory on next page.

EDWARD █ : ABCDE

8. Press [SET].

➔ The display shows the next Dial Bank.

- Repeat steps 5-8 to attach a name to other phone numbers of Dial Bank.

1 1 1 4 4 4

9. Press [STOP] twice to finish editing.

26 Jun. '97 12:00

- The Dial Bank memory holds 20 numbers you dialed most often. When a new number is added, the Dial Bank bumps out the oldest number with the least frequency. Once a number in the Dial Bank gets a name, the number will not be bumped out until you intentionally erase by erasing operation (see next page).

### Transferring to one-touch dial/speed dial memory

Perform steps 1-4 of **Adding a name**, and follow the instructions below:

5. Press [DIAL BANK] to select the number to be transferred.

1 1 1 2 2 2 3 3 3

6. Press [MENU].

DESTINATION ?

7. Press a one-touch dial key (0-9) or press [SPEED DIAL] and enter a 2-digit speed dial number for the destination.

O. T : 3

**Example:** You select the one-touch key 3.

8. Press [SET].

➔ A beep sounds.

- Repeat steps 5-8 to transfer other numbers.

TRANSFERRED

9. Press [STOP] twice to finish transferring.

26 Jun. '97 12:00

### Erasing a number in dial bank

Perform steps 1-4 of **Adding a name**, and follow the instructions below:

5. Press [DIAL BANK] to select the number to be erased.

1 1 1 2 2 2 3 3 3

6. Press [DELETE].

DELETE DATA ?

7. Press [SET].

➔ A beep sounds.

➔ The display shows the next number stored in the Dial Bank.

- Repeat steps 5-7 to delete other numbers.

DELETED

8. Press [STOP] twice to finish erasing.

26 Jun. '97 12:00

## Calendar and clock

To set the date and the clock time.

1. Press **[MENU]** 4 times.

4 : SET MODE ?

2. Press **[SET]**.

1 : SET TIME ?

3. Press **[SET]**.

23 04. ' 97 15:00

4. Enter the day, month, year and time using the number keys.

- The time must be entered using 24-hour system.

- The day, month and year should be entered as 2 digits each.

**Example:** to enter 26 June, 1997, 12:00,  
press [2], [6], [0], [6], [9], [7], [1],  
[2], [0] and [0].

26 06. ' 97 12:00

5. Press **[SET]**.

➔ A beep sounds.

2 : STATION CODE ?

6. Press **[STOP]** to finish calendar/clock setting.

26 Jun. ' 97 12:00

• If you make a mistake, move the cursor to the appropriate place, then enter the correct number.

Press **[▶]** to move the cursor right.

Press **[◀]** to move the cursor left.

## Header print (Setting your station name and fax number)

Once you have programmed your station name and fax number into the SFX-107 memory, this information appears at the top of all faxes you send.

1. Press **[MENU]** 4 times.

4 : SET MODE ?

2. Press **[SET]**.

1 : SET TIME ?

3. Press **[MENU]**.

2 : STATION CODE ?

4. Press **[SET]**.

■ : ABCDE

5. Enter your station name.

A maximum of 24 characters can be entered.

(See "Entering names" on pages 42-43.)

CHARLES ■ : PQRST

6. Press **[SET]**.

■

7. Enter your fax number.

Your fax number can be entered up to 20 digits in length.

Example: 111-2222

111-2222

8. Press [SET].

→ A beep sounds.

3: FEATURE SW. ?

9. Press [STOP] to finish header programming.

26 Jun. '97 12:00

- To interrupt programming, press [STOP] twice.
- If you make a mistake in entering a number, move the cursor over the wrong digit using the [▶] (one-touch key 6) or [◀] (one-touch key 5). Press [DELETE] (one-touch key 0) to erase it. Then enter the right digit.

- To enter a hyphen (-) between two digits, press [SPEED DIAL].
- To enter a plus sign (+) preceding your fax number, press [HOLD].
- The header can be printed either outside the original document (in the top margin) or inside the document itself. You can select the desired setting using feature switch No. 20 (See pages 57-58 and 60) Default setting is printing outside of the original.

**NOTE:** If you choose to print the header inside the document, the top of the original document (about 1 cm/0.4") may not be reproduced.

Printing header outside of the original.

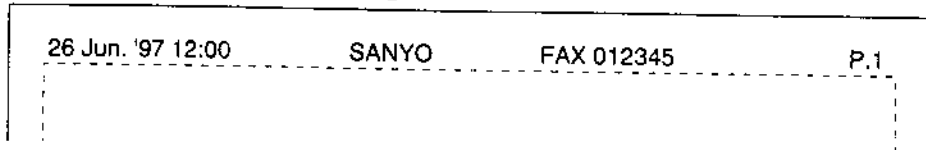

Printing header inside of the original.

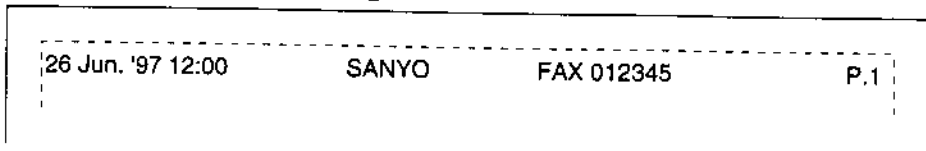

# Activity report

You can program the SFX-107 to issue an activity report once everyday or after about 20 transmissions/receptions have been performed. It can also be set to issue no activity report.

1. Press [MENU] 4 times.

4: SET MODE ?

2. Press [SET].

1: SET TIME ?

3. Press [MENU] 3 times.

4: ACT. REPORT ?

4. Press [SET].

ACT. REPORT ON

5. Press [MENU] to select ON or OFF.

- If you choose OFF, proceed to step 8.

Example: ON

ACT. REPORT ON

6. Press [SET].

PRINT TIME : ■

7. Enter the desired issue time using the number keys.

- The time must be entered using 24-hour system.

Example: 16:00

PRINT TIME 16:00

8. Press [SET].

- A beep sounds.

5: REFUSE LIST ?

9. Press [STOP] to return to standby mode.

26 Jun. '97 12:00

Programming

- If you make a mistake when entering the issue time, press **[DELETE]** to clear the incorrect time, and then enter the correct time.
- If the issuing time is not entered at step 7, an activity report is printed automatically when the number of activities (transmission and reception) reaches about 20.
- The initial factory setting is ON with no issue time set.
- If your activities have not been performed, an activity report is not issued at setting time.

#### Sample of activity report

*** ACTIVITY REPORT ***						
26 Jun. '97 12:00						
			TRNS. TOTAL PAGE 000003			
			RECV. TOTAL PAGE 000002			
TRNS.						
No.	DATE	START	TIME	PARTNER	PAGE	RESULT ERROR CODE
1	26 Jun.	9:00	1'23	AAA	2	OK
2	26 Jun.	10:00	0'45	BBB	1	OK
RECV.						
No.	DATE	START	TIME	PARTNER	PAGE	RESULT ERROR CODE
1	26 Jun.	9:30	1'02	CCC	1	OK
2	26 Jun.	10:30	0'38	DDD	1	OK

## Feature switches

The various feature switches on the SFX-107 were factory-preset to standard (default) settings. To provide you with more choices, the SFX-107 allows you to change these feature switch settings.

The feature switches and their functions are listed on pages 59-60.

#### To change feature switch settings:

1. Press **[MENU]** 4 times.

4 : SET MODE ?

2. Press **[SET]**.

1 : SET TIME ?

3. Press **[MENU]** twice.

3 : FEATURE SW. ?

4. Press **[SET]**.

(0 0) DIAL MODE

5. Enter the number of the switch you want to change.

(0 1) PAUSE TIME

**Example:** To change the pause time, press **[0]** and **[1]** to select feature switch No. 01.

6. Press **[SET]**.

3 sec (0 3)

7. Enter the code of your choice.  
 (See pages 59-60 for available codes.)  
**Example:** To change the pause time to 4-second, enter [0] and [4].

4 s e c (04)

8. Press [SET].  
 Repeat steps 5-8 to make additional changes (as required).

(05) TIMER REDIAL

9. Press [STOP] twice to finish feature switch programming.

26 Jun. '97 12:00

10. Print a feature switch list (see page 61) for your confirmation.

• To interrupt the feature switch setting procedure, press [STOP] twice.

## Feature switch list

Switch No.	Switch description	Code No.	Code description	Factory setting
00	Dial mode	00	TONE	01
		01	PULSE (10 PPS)	
01	Pause time	02	2 sec.	03
		03	3 sec.	
		04	4 sec.	
		05	5 sec.	
		06	6 sec.	
		07	7 sec.	
		08	8 sec.	
		09	9 sec.	
		10	10 sec.	
		11	11 sec.	
		12	12 sec.	
		05	Number of redial attempts after timer transmission attempt. (3 to 4-minute intervals)	
01	once			
02	twice			
03	3 times			
06	Number of automatic redial attempts for regular fax transmission after busy signal is detected using manual, one-touch or speed dialing. (2-3 minutes intervals)	00	OFF(No redial)	02
		01	once	
		02	twice	
		03	3 times	
07	Ring delay Number of rings the unit issues before connecting to the line when the unit is set to the AUTO mode.	00	One short ring	03
		01	1 ring	
		02	2 rings	
		03	3 rings	
		11	11 rings	
08	Remote reception activation number	00	OFF	33
		10 to 99	ON(Select a 2-digit number of your choice)	
09	The simulated ring count that the SFX-107 issues after connecting to the line during the AUTO reception mode, but before switching to fax reception mode for an incoming manual fax (or voice call).	00	OFF(No rings/No auto switching)	00
		01	3 rings(Auto switching)	
		02	5 rings(Auto switching)	
		03	7 rings(Auto switching)	
		04	9 rings(Auto switching)	
		05	11 rings(Auto switching)	
10	Music-on-hold	00	OFF(No music)	01
		01	ON (Green sleeves)	

Switch No.	Switch description	Code No.	Code description	Factory setting
17	Key operation beeps	00	OFF	02
		01	LOW	
		02	HIGH	
20	Header print Determines whether your station name, fax number and date/time are printed on the header.	00	OFF	01
		01	ON (Printing outside of original)	
		02	ON (Printing inside of original)	
26	Selective reception Determines whether reception is controlled by your ACCEPT or REFUSE list.	00	OFF	00
		01	ACCEPT	
		02	REFUSE	
27	Home position of the resolution mode	00	STD	03
		01	FINE	
		02	SUPER FINE	
		03	Not return	
28	Home position of the contrast mode	00	NORMAL	03
		01	LIGHT	
		02	HALFTONE	
		03	Not return	
32	Timer transmission report	00	OFF (No report)	00
		01	ON (after each timer transmission)	
		02	ON (when an error occurs)	
36	Haiftone quality (relative to transmission speed)	00	Faster transmission	01
		01	Better haiftone quality at slower speed	
54	Auto progress transmission/reception	00	OFF (need to press [START] key for manual transmission/reception)	01
		01	ON (no need to press [START] key for manual transmission/reception)	
56	Duplex ringing	00	OFF	00
		01	ON	

## Printing a feature switch list

You can print a list of all feature switches and their current settings.

1. Press [MENU] 4 times.

4:SET MODE ?

2. Press [SET].

1:SET TIME ?

3. Press [MENU] twice.

3:FEATURE SW. ?

4. Press [COPY].

FEATURE SW. LIST

5. Press [STOP] after printing to return to standby mode

26 Jun. '97 12:00

### Sample of the feature switch list

```

* * * FEATURE SW. LIST * * *
26 Jun. '97 12:00

No. SWITCH NAME          SET CODE      INITIAL SET
[00] DIAL MODE            (01) 10PPS    (01) 10PPS
[01] PAUSE TIME           (03) 3sec     (03) 3sec
[05] TIMER REDIAL         (03) 3 TIMES  (03) 3 TIMES
[06] AUTO REDIAL          (02) 2 TIMES  (02) 2 TIMES
[07] No. OF RINGS         (03) 3 TIMES  (03) 3 TIMES
[08] REMOTE Rx.           (33) 33       (33) 33
[09] F/T SW. OVER         (00) OFF      (00) OFF
[10] MELODY                (01) GREENSLEEVES (01) GREENSLEEVES
[17] KEY SOUND             (02) HIGH     (02) HIGH
[20] HEADER PRINT          (01) ON:OUTSIDE (01) ON:OUTSIDE
[26] SELECTIVE R.         (00) OFF      (00) OFF
[27] RESOLUTION           (03) NOT RETURN (03) NOT RETURN
[28] CONTRAST              (03) NOT RETURN (03) NOT RETURN
[32] TIMER REPORT          (00) OFF      (00) OFF
[36] HALFTONE              (01) HIGH QUALITY (01) HIGH QUALITY
[54] AUTO PROG.           (01) ON       (01) ON
[56] DUPLEX RING.         (00) OFF      (00) OFF

```



## Thermal paper handling

Thermal paper is heat-sensitive. Follow the precautions below while handling it.

### Storage precautions

Thermal paper will start to discolor gradually at about 70°C (158°F).

It should not be exposed to heat, humidity or light, even when not in use.

Take the following storage precautions.

1. Store in a dark, cool and dry place.

Avoid storing near heat-generating appliances or in enclosed places subject to high temperatures (the trunk of a car, for example.)

2. Once the package is opened, use the paper as soon as possible.

### Handling precautions

1. If thermal paper is touched with sweaty hands, fingerprints or smeared images may result.

2. If thermal paper is rubbed against a hand, coloring may be caused by heat due to friction.

3. Coloring or erasure may occur if oil or other chemicals are allowed to come into contact with the paper.

Be careful in the following cases:

- When gluing, use only water-soluble glue (commercially available).

- When some adhesive tapes are used, coloring may result. The use of double-sided tapes on the back of the paper is recommended.

- When storing the paper in plastic cases, use those made of polyethylene, polypropylene or polyester.

(Do not use PVC cases.)

- Do not stack the paper along with polyvinyl chloride (PVC) films or heat-sensitive wax-type paper. The recorded images will fade, as these materials contain plastics.

- Do not stack the paper with diazo- or wet-type photocopies immediately after they have been copied on. Ammonia, etc., may cause discoloring.

- The paper will discolor if it comes into contact with alcohol or other volatile organic solutions.

4. Avoid exposing the paper to direct sunlight, as this tends to cause yellowing.

## Jammed original

A beep sounds and display shows "ORIGINAL JAM", if an original document jams.

(If the **ERROR** lamp lights when the original jams, press **[STOP]** before operating below.)

1. Lift the operation panel forward.

2. Raise the document release lever.

3. Remove the jammed paper while pressing the green release lever.

4. Reposition the release lever and close the operation panel.

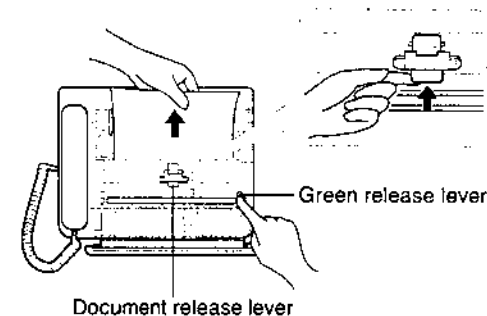

## Mechanical error

When the display shows "MECHANICAL ERROR", operate the following procedure to clear the error.

(If the **ERROR** lamp also lights, press [**STOP**] before operating below.)

1. Open the original document tray.

2. Lift the operation panel.

3. Press [**OPEN**] button to open the recording cover.

4. If the cogwheel ① is stuck in the cogwheel ② as shown figure 1, lift the cogwheel ①. (See figure 2)

- The correct position of cogwheel ① and ② shows in the figure 3.

5. Reinsert the end of recording paper roll to recording paper exit.

6. Close the recording paper cover securely by pressing on the left and right front corners of the far end of the cover.

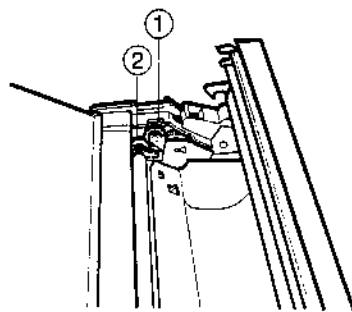

Figure 1

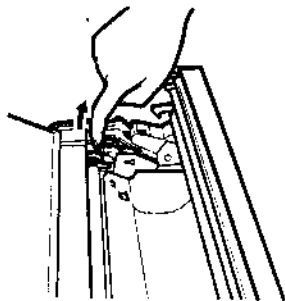

Figure 2

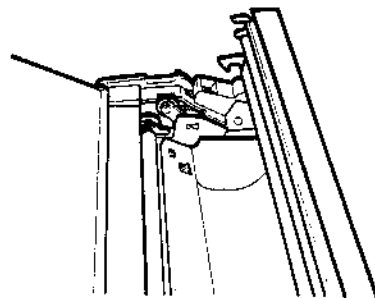

Figure 3

- If the "MECHANICAL ERROR" display cannot still be cleared, contact an authorized Sanyo service center.

## Cleaning

### Cleaning the housing (exterior plastic parts)

Gently wipe the housing with a soft, clean cloth dampened with a small amount of a neutral detergent.

- Do not use a cleaning agent such as alcohol or benzene.

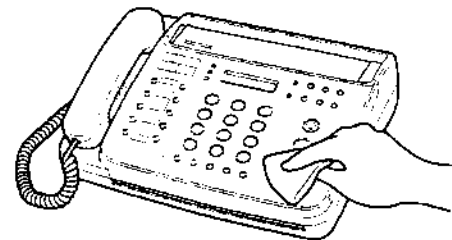

### Cleaning the document feed roller-2

If a streak or dirty pattern appears on a copy or a fax you have sent, clean the document feed roller-2 with a soft, clean cloth dampened with a small amount of neutral detergent.

1. Open the original document tray.

2. Open the operation panel.

3. In order to rotate the document feed roller-2, press the document sensor as shown in the illustration.

4. Clean the document feed roller-2, then dry it thoroughly to prevent the document from jamming.

5. Close the operation panel.

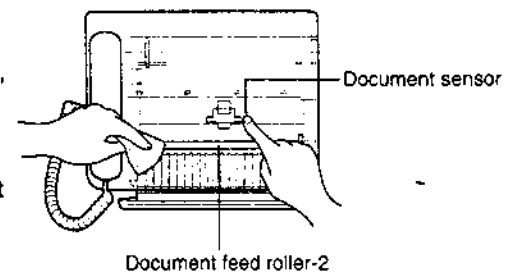

### Cleaning the document feed roller-1

If the document jamming or overlapping frequently occurs, clean the document feed roller-1 with a cotton swab dampened with a small amount of a neutral detergent.

1. Open the original document tray.
2. Open the operation panel, and then raise the document release lever.
3. In order to rotate the document feed roller-1, press the document sensor as shown in the illustration.
4. Clean the document feed roller-1, then dry it thoroughly to prevent a document from jamming.
5. Reposition the release lever and close the operation panel.

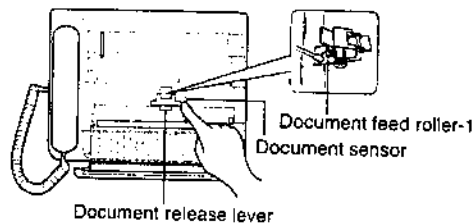

## Troubleshooting

If problems occur during operation, check below before taking the unit for service. If the problem cannot be corrected, contact the dealer from whom the unit was purchased.

	Symptoms	Possible causes/solution	Page
General	Unit does not operate.	AC plug may not be connected to electrical outlet.	10
	The display indicates <b>CHECK PAPER ROLL</b>	Recording paper may not be set properly.	12
		Recording paper may have run out.	-
	Document cannot be inserted.	Document may be too thin or too thick.	21
Another document may be jammed inside. Open operation panel and remove jammed document.		63	
You may have placed more than 5 sheets.		22	
Transmitting	Transmission is not possible.	Document may not be inserted far enough into the slot.	22
		Recording paper may have run out on receiving unit.	-
		Receiving unit may be set for manual reception.	-
Reception	Reception is not possible.	Unit may be set for manual reception. Lift the handset and incoming fax transmission can be received without pressing [START] key.	33
		Power cord may not be connected.	10
		Recording paper may have run out.	-
		Selective reception may be set to on. Check feature switch No. 26.	37
	Received copy is not dark enough.	The recommended recording paper is not used.	13
		Transmitted original may be light.	23
	Received copy is blank.	Recording paper may have been inserted upside down.	12
		Transmitted original may have been upside down.	-
Received copy contains illegible/distorted characters.	Phone connection may have been poor. (If problem continues, contact dealer.)	-	
Red line appears on recording paper	Recording paper has almost run out. Install a new recording paper roll.	12	

	Symptoms	Possible Causes/Solution	Page
Error lamp	Error lamp lights.	Press [STOP] to turn off the error light. May be a communication error due to a poor line connection.	-
Phone call	No dial tone when handset is picked up.	Telephone code may not be connected properly.	10
	Sound from speaker is too low.	Monitor volume switch may be set to lower position.	7
	No rings are heard.	Ringer volume switch may be set to "OFF".	7
Extension phone	Fax/phone call does not connect to other party.	Wrong dialing mode may be set. Check the feature switch No.00.	11
	Impossible to place phone call.	Fax possibly being transmitted or received.	-
	Telephone does not ring.	Too many phones may have been connected to the same line.	10
	Remote reception does not work.	Remote reception feature switch (No. 08) may have been set to off. If you have initiated the call from the extension phone, remote reception will not work.	59 -

## Specifications

Model	SFX-107
Type	Desktop type transceiver
Line connected	Public switched telephone network
Size of recording paper	216 mm (8.5") x 30 m (98') / 25 m (82')*
Effective scanning width	208 mm (8.2")
Effective recording width	212 mm (8.3")
Transmission speed	9600/7200/4800/2400 BPS
Main scanning density	8 pels
Sub scanning density	3.85 lines/mm (Standard mode) 7.7 lines/mm (Fine mode) 15.4 lines/mm (Super fine mode)
Compression mode	MH (Modified Huffman) and Sanyo original
Reading method	Flat-bed by contact image sensor
Recording method	Flat-bed by thermal printing head
Power supply	AC 220V, 50/60 Hz
Power consumption	Stand-by: 7 W, Transmission: 20W, Reception: 85W, Copy: 75W
Overall dimensions	337(W) x 104(H) x 255(D) mm 13.3"(W) x 4.1"(H) x 10.1"(D)
Weight	Approx. 3.4 kg (7.7 lb)
Ambient temperature	5°C -35°C (41°F - 95°F)

\* High-grade thermal paper comes as 25-m roll.

### Optional accessories:

Part name	Part No.
Thermal paper (30m/98')	R-4079448-1
High-grade thermal paper (25m/82')	3RE2182800450