

AIPTEK[®]

POCKETCAM X

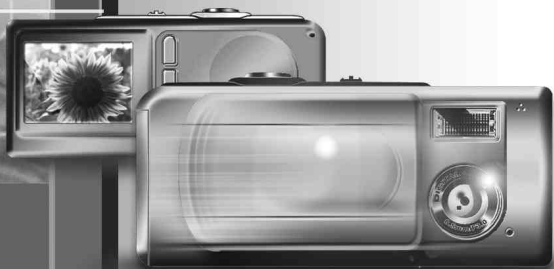

POCKETCAM X

PocketCam X

User Manual

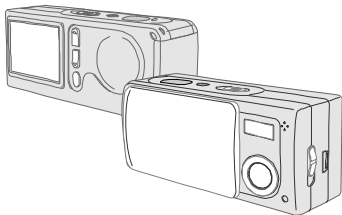

AIPTEK Service

AIPTEK, Inc.
51 Discovery, Suite 100
Irvine, CA 92618, USA
TEL: 949-585-9600
FAX: 949-585-9345
<http://www.aiptek.com>

Online registration
<http://www.aiptek.com/registration/registration.htm>

(Online registration entitles you to special services, downloads and promotions.)

| WELCOME |

Dear user, thanks for purchasing this product. Much investment in time and effort has gone into its development, and it is our hope that it will give you many years of trouble-free service.

CAUTION

1. Do not drop, puncture or disassemble the camera; otherwise the warranty will be voided.



2. Avoid all contact with water and dry hands before using.



3. Do not expose the camera to high temperature or leave it in direct sunlight. Doing so may damage the camera.



5. Use the camera with care. Avoid pressing hard on the camera body.

6. For your own safety, avoid using the camera when there is a storm or lightning.



Avoid using batteries of different brands or types at the same time.

7. There is potential of explosion by doing that.



8. Remove batteries during long periods between usage, as deteriorated batteries may affect the functionality of the camera.

9. Remove batteries if they show signs of leaking or distortion.





We suggest using only the accessories supplied by the manufacturer.

WELCOME CAUTION

Getting Started 3

- 1. Your camera parts 3
- 2. Loading the battery 4
- 3. Inserting and removing the SD/MMC card (optional) 5
 - Inserting the card 5
 - Removing the card 5
- 4. Attaching the strap (optional) 6
- 5. Using the tripod (optional) 6



Basic operation 7

- 1. Powering on and off 7
 - Using the Lens cover 7
 - Using the Power button 7
- 2. Setting the Mode switch 7
- 3. Taking still pictures 8
 - Snapshot 8
 - Focus 8
 - Zoom in/out 8
 - Flash strobe and self-timer 9
 - The LCD display under  mode 9
- 4. Recording movies 10
 - The LCD display under  mode 10

Playing Your Images on the LCD at Once 11

- 1. Viewing pictures and movies 11
 - The LCD display under  mode 11
- 2. Deleting the picture and movie 12



Advanced Operation and Settings 13

- 1. Using the MENU button 13
 - MENU under  mode 13
 - MENU under  mode 14
 - MENU under  mode 15
- 2. Configuring settings 16

Enjoying Viewing Your Images on a PC 17

- 1. Installing the PocketCam X driver 17
- 2. Connecting your camera to your computer 20
- 3. Copying pictures and movies to your computer 21
- 4. Viewing on your computer 23

Using the PC Camera Function for Fun 24

- 1. Installing the PocketCam X driver 24
- 2. Connecting your camera to your computer 24
- 3. Capturing immediate images to your computer 26
- 4. Advanced settings 28
 -  Format settings 28
 -  Properties settings 29

Troubleshooting 30

Other Information 32

- 1. Life of battery 32
- 2. LED indicator events 32
- 3. Storage Capacity 33
- 4. More on flicker 33
- 5. Specification 34

1. Your camera parts

Knowing your camera parts well before using it will help you operate it more easily.

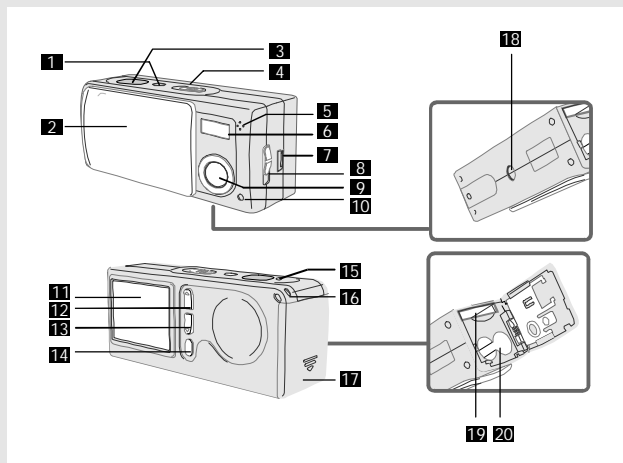

- | | |
|-------------------------------------|---------------------------------------|
| 1 Power button | 11 LCD display |
| 2 Lens cover | 12 Control button ▲ (Zoom in) |
| 3 Shutter /Quick Exit button | 13 Control button ▼ (Zoom out) |
| 4 Mode switch | 14 MENU/OK button |
| 5 Microphone | 15 LED indicator |
| 6 Flash strobe | 16 Strap holder |
| 7 USB port | 17 Battery/ SD/MMC card cover |
| 8 Focus switch | 18 Tripod port |
| 9 Lens | 19 SD/MMC card slot |
| 10 Self-Timer LED indicator | 20 Battery section |

2. Loading the battery

Please use two AAA 1.5V batteries.

! We recommend you to use alkaline batteries.

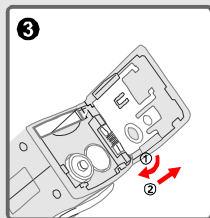
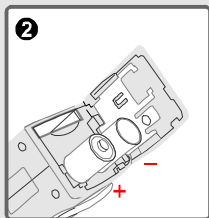
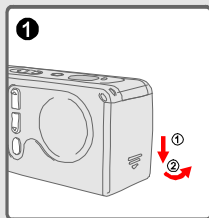

1 Slide the battery/card cover in the direction of the indication to open it.

2 Follow the indication to load two AAA batteries.

3 Close inward and slide upward the battery/card cover to lock it.

✓ For details of the battery life, see the "Life of battery" section on page 32.

3. Inserting and removing the SD/MMC card (Optional)

! Never eject the SD/MMC card while the camera is processing data. (The LED indicator lights red while the camera is processing data. For more information on the LED messages, please see the "LED indicator events" section on page 32)

► Inserting the card

- 1 Open the battery/card cover.
- 2 Insert the card in the direction of the indicator and push it in till the end of the card slot.
- 3 Close the battery/card cover.

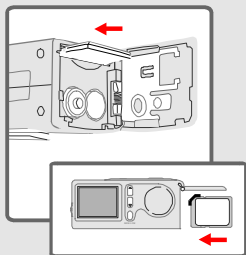

► Removing the card

Push in and release the card to remove it.



The camera comes with 16MB flash memory built inside for storage. If you do not insert a SD/MMC card, the data will be saved in the built-in flash memory automatically.

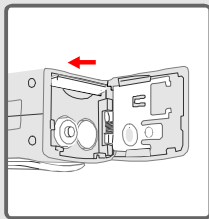

- ✓** For details of the storage capacity of the SD/MMC card and internal memory (16MB flash memory), please see the "Storage capacity" section on page 33.

4. Attaching the strap (Optional)

For convenience and safety, you may wish to attach the carrying strap.

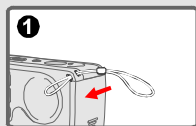

- 1 Thread the strap loop through the holder in the direction indicated.

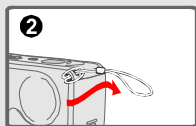

- 2 Fasten the strap as indicated.

5. Using the tripod (Optional)

The tripod can be attached to your camera to minimize camera movement and ensure optimal image quality, particularly while taking self-portraits, longer movies or in a macro mode.

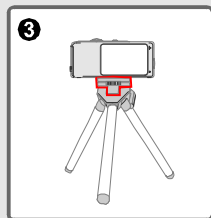
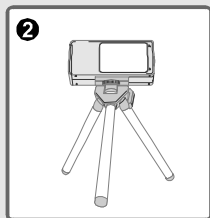
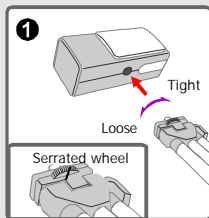

- 1 Attach the tripod to the port on the bottom of the camera and rotate the serrated wheel to lock it.
- 2 Unfold the legs to set up.
- 3 Adjust the alignment to the desired position.

1. Powering on and off

Slide the Lens cover or press the Power button to power on or off the camera.

▶ Using the Lens cover

Slide the Lens cover in the direction of the arrow to turn the power on or off.

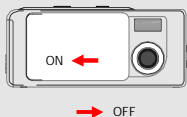

- ✔ While the Lens cover is open, you can also press the Power button to deactivate your camera.

▶ Using the Power button

Press the Power button to turn the power on or off.

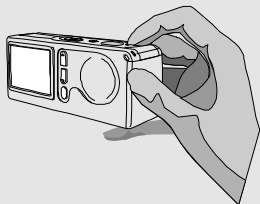

If the camera is idle for over 60 seconds, the LCD display will be turned off to conserve battery power; press any key to wake up the camera. If it is idle for over 3 minutes, the camera will shut down automatically.

2. Setting the Mode switch

This camera provides three modes to use. Push the Mode switch to select the mode that you want to use.

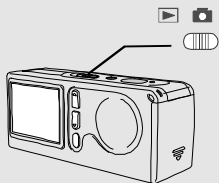

 Movie mode

 Still Picture mode

 Playback mode

3. Taking still pictures

Follow the steps to snap stills. Also use the Focus switch to set the focus and the Control buttons \blacktriangle \blacktriangledown to adjust zoom in or zoom out so that you can get best result.

► Snapshot

- 1 Set the Mode switch to .

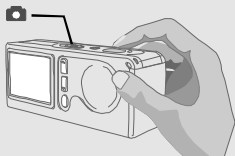



- 2 Press the Shutter button to take pictures.

- While the LED indicator is flashing red, the image is being captured; while the LED turns green, the picture processing is done. (For more information of the LED message, please see the "LED indicator events" section on page 32.)

► Focus

Adjust the focus before taking the still picture. Push the Focus switch, then select the mode best for your picture. The following table tells you which focus mode you may choose with the distance from the object.



	Macro	12"~24" (30cm~60cm)
	Micro	24"~∞ (60cm~∞)

► Zoom in/out

Press the Control button \blacktriangle to zoom in or the Control button \blacktriangledown to zoom out.

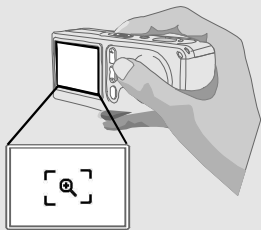

► Flash strobe and self-timer

The strobe and self-timer are provided to offer more convenient utilities when taking pictures. You can use the strobe if the light is not adequate. The self-timer function is useful in certain situations (ex. taking self-portrait photo). There are other settings in the MENU under mode to affect the result of image, including size, exposure, white balance, and effect. For details on operation and information, please see page 13-14.

► The LCD display under mode

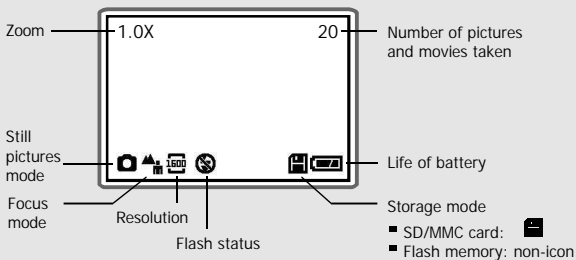

4. Recording movies

- ① Set the Mode switch to .

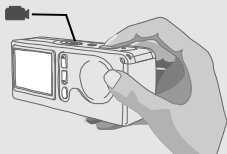

- ② Press the Shutter button to start recording.

- ③ Press the Shutter button again to stop the recording.

- ✓ You can also adjust the Focus switch under  mode. (Please refer to the "Focus" section on page 8.)
- ✓ The resolution of movie is 320*240 pixels.

► The LCD display under mode

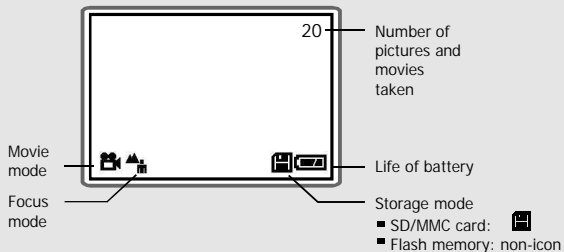

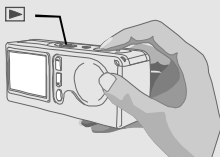

1. Viewing pictures and movies

- ① Set the Mode switch to .



- ② The last image taken will be highlighted first on the LCD display.

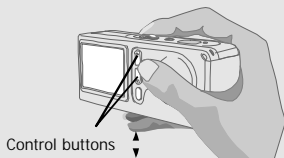

- ③ Press the Control buttons   to select the previous or the next image, then view it on the LCD display.

- While playing a movie on the camera, sound playback is not available. Please copy the movie to your computer (for details, see page 17) to view it with sound playback.



▶ The LCD display under mode

The type you are viewing

- Picture: 
- Movie: 

Playback mode



Picture and movie number

Number of pictures and movies taken

Life of battery

- It appears under the status of low battery only.





Storage mode

- SD/MMC card: 
- Flash memory: non-icon

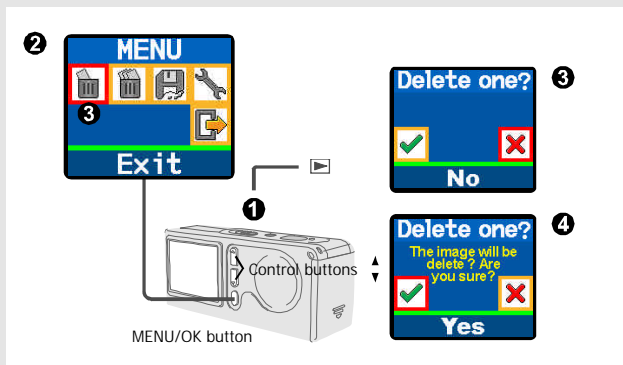
2. Deleting the picture and movie

Follow the steps if you want to delete one picture or movie.



- 1** Push the Mode switch to , then press the Control buttons  to pick the image you want to delete.
 - 2** Press the MENU/OK button to enter the MENU.
 - 3** Press the Control buttons  to choose "Delete One", then press the MENU/OK button.
 - 4** Pick "Yes" with the Control buttons , then press the MENU/OK button to complete the action of deletion.
- Press the Shutter/Quick Exit button if you want to quick exit the MENU at anytime.













1. Using the MENU button



The MENU provides more advanced features for you to fine-tune the camera. Use the MENU/OK button to enter the MENU. Press the Control buttons \blacktriangle to highlight the item. Use the MENU/OK button to confirm. Then use the Shutter/Quick Exit button to exit immediately.

► MENU under  mode





- ✓ The MENU/OK button is for either entering the MENU or executing an action.
- ✓ Select the  icon to exit; or press the Shutter/Quick Exit button to quick exit.

Item	Option	Icon		Description
		MENU	LCD display	
① Size	2048x1536 1600x1200 1280x960	  	  	This item allows you to change the resolution of the picture. Select the "1600x1200" or "2048x1536" type when you want to develop 4x6 photos; select the "1280x960" when you want to develop 3x5 photos.
② Strobe	Auto Off	 	 	This item allows you to set the flash strobe. When you are not sure if the light is adequate, select the "Auto" mode. The strobe will fire automatically if more light is needed. If you have problems when using the strobe, please refer to "Troubleshooting".
③ Self-Timer	On Off	 	 N/A	This item allows you to specify the delay for 10 seconds before the shutter fires. If you want to use the self-timer, set the "On" mode, press the Shutter button, then wait for 10 seconds with Self-Timer LED indicator flashing red.

4 Exposure	Auto Back Light		N/A	This item allows you to set the exposure-metering mode. When you are not sure the source of light or when the object faces the light, select the "Auto" mode. When the object is against the light, select the "Back Light" mode.
5 White Balance [WB]	Auto Sunny Cloudy Fluorescent Tungsten		N/A	This item allows you to set the color temperature with the light in the certain environment. If you know the color conditions of your shooting environment, such as the "sunny" (bright), "cloudy" (dim), "fluorescent" (high color condition) and "tungsten" (low color condition) situations, select the mode you consider most appropriate. Select the "Auto" mode if you are not sure the color condition of the environment.
6 Effect	Normal B&W Classic Solarize		N/A	This item offers four scenes of photo imaging, such as the "Normal" (no effect), "B&W" (black and white), "Classic" (old picture), and "Solarize" (over-exposed) effects.
7 Setting	See page 16 for details.			

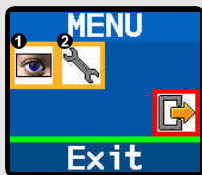





▶ MENU under  mode



Item	Option	Icon		Description
		MENU	LCD display	
1 Effect	Normal B&W		N/A	This item allows you to set the effect of the image, such as the "Normal" (no effect) and "B&W" (black and white) effects.
2 Setting	See page 16 for details.			

▶ MENU under  mode



Item	Option	Icon		Description
		MENU	LCD display	
❶ Delete One	Yes		N/A	This item allows a picture or a movie stored in your built-in flash memory or the SD/MMC card to be deleted.
	No			
❷ Delete All	Yes		N/A	This item allows all files stored in your built-in flash memory or the SD/MMC card to be deleted.
	No			
❸ Format	Yes		N/A	This item allows all files stored in your built-in flash memory or the SD/MMC card will be deleted and formatted. Note that all stored files will be gone and cannot be restored.
	No			
❹ Setting	See page 16 for details.			

2. Configuring settings

Highlight the  icon with the Control buttons \updownarrow in the MENU for configuration. The following figures are the Setting displays under the three modes. The table is the description of all items in the Setting.

Setting under  mode









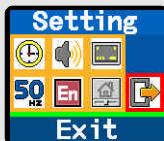

Setting under  mode



Setting under  mode



The description of the Setting items

Item	Option	Icon	Function
1 Time	Year Month Day Hour Minute	N/A	This item allows you to set the time of the camera. Use the Control buttons \updownarrow to change the number of settings. Press the MENU/OK button to confirm.
2 Beep	On Off		This item determines whether the beep sounds when operating the camera.
3 Display	On Off		This item determines whether the small icons for illustration will appear on the LCD screen.
4 Date Stamp	On Off		This item determines whether a date stamp will appear on the pictures taken.
5 Flicker	50HZ 60HZ	 	This item allows you to set the flicker to prevent noise and get the best image. The default flicker value is based on your country. See the "More on flicker" section on page 33 for details.
6 Language	English Duestch	 	This item allows you to set the usage of language on the LCD display.
7 Default	Yes No	 	This item determines whether all your settings will be returned to the original factory default.

1. Installing the PocketCam X driver

Install the PocketCam X driver before connecting your camera to your computer for the first time. Please follow the steps to complete the installation.

! For Windows XP users: Skip step 1. (Installing the PocketCam X driver) and go to step 2. (Connecting your camera to your computer) if you do not use the PC Camera function.

1 Turn on your computer.

! Do not connect the USB cable to your computer at this stage.

! Turn off other applications running on your computer.

2 Place the supplied CD into the CD-ROM drive.

3 Move the mouse to "PocketCam X Driver" and click it.

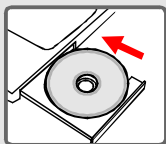

The title appears on the screen in a few seconds.



Click the "PocketCam X Driver" item.



If no title appears on the screen

Please follow the steps:

- ① Double-click the "My computer" icon.
- ② Double-click the CD-ROM drive icon ("PocketCam X (E:)*").
*The name of CD-ROM drive changes depending on how your computer is set up.

- 4 The "Install Shield Wizard" dialog box is occurring and the automatic installation begins. When a window as Fig1 appears, click "Next".

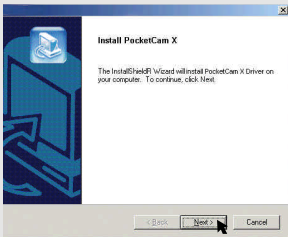
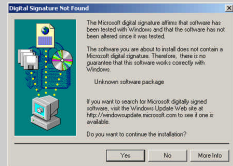

Fig 1



Notice for Windows 2000 users

- ① The "Digital Signature Not Found" dialog box might show twice. Please simply click "Yes". This camera works well for Windows 2000.



- ② Follow the on-screen instructions and click "Finish".

! Do not restart your computer at this step.

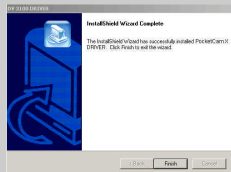

- 5** When a window as Fig2 appears, please click "Yes" or "No" according to your circumstance.
- ① If you are not a Windows XP user, or never install DirectX 8.0 or above, click "Yes".
 - ② If you are a Windows XP user, or you already installed DirectX 8.0 or above, click "No".

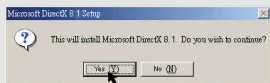

Fig 2

- 6** When a window as Fig3 or Fig4 appears, please click "Finish" or "Ok" to complete the installation.

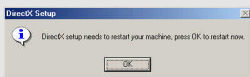

Fig 3

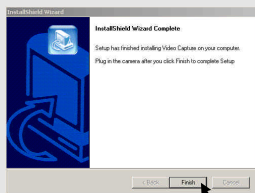
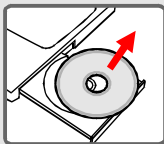



Fig4

- The driver will be available after restarting your computer.

- 7** Take the CD out.



2. Connecting your camera to your computer

- 1 Turn on your computer.
 - 2 Set the Mode switch on your camera to  or  .
 - 3 Insert the USB cable to the USB port on your computer.
-

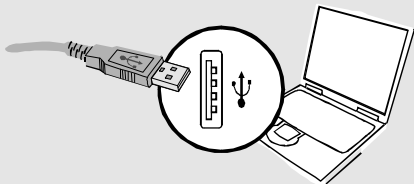

- 4 Insert the other end of the USB cable to the USB port on your camera.

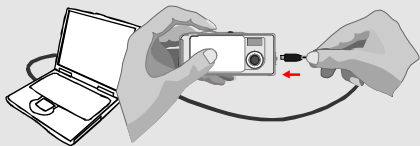

3. Copying pictures and movies to your computer

1 ■ For Windows XP users

After connecting your camera with the computer, a window will automatically appear (as Fig 5). Select the "Open folder to view files using Windows Explorer" item and click "Ok".

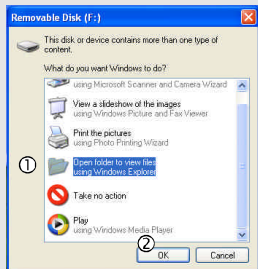

Fig 5

■ For Windows 2000/ ME/ 98SE users

Double-click "My computer", then double-click the new "Removable Disk" icon.



2 Double-click the "DCIM" file folder.

■ For Windows XP users

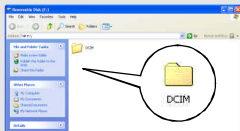

■ For Windows 2000/ ME/ 98SE users

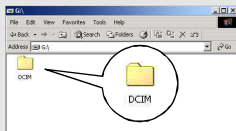

3 Double-click the "100MEDIA" file folder.

■ For Windows XP users

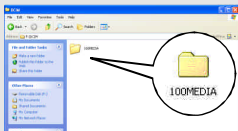

■ For Windows 2000/ ME/ 98SE users

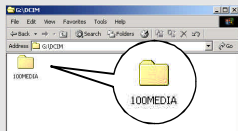

4 Drag the picture to the "My Documents" file folder to copy your picture or movie to the computer.

■ For Windows XP users

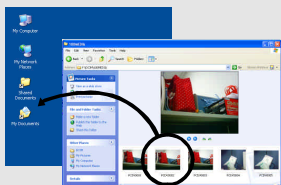

■ For Windows 2000/ ME/ 98SE users

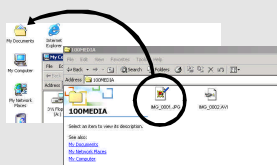

The storage positions of the pictures and movies

You can find the files of your pictures and movies as Fig 6.

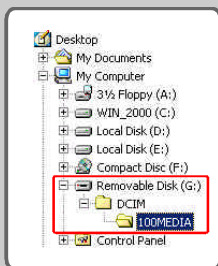

Fig 6

4. Viewing on your computer

① Double-click "My Documents".

■ For Windows XP users



■ For Windows 2000/ ME/ 98SE users

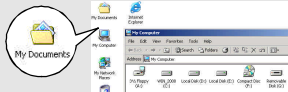

② Select the desired file and double-click it to view your picture or movie.

■ For Windows XP users

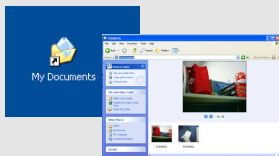

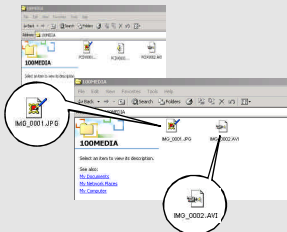

■ For Windows 2000/ ME/ 98SE users



Notice on disconnecting the camera from the computer for Windows 2000/ ME users

To disconnect your camera from the computer, please follow these steps:

- ① Double-click  on the task bar.
- ② Click  (USB Disk), then click "Stop".
- ③ Confirm the device (PocketCam X) on the confirmation screen and click "Ok".
- ④ Follow the on-screen instruction to disconnect your camera from your computer correctly and safely.

1. Installing the PocketCam X driver

You need to install PocketCam X driver before using PC Camera or Video Conferencing function.

- ❗ Skip step 1. (Installing the PocketCam X driver) and go to step 2. (Connecting your camera to your computer) if you have already installed PocketCam X driver.
- ❗ If you never install PocketCam X driver, please finish the installation first. For details, please see step 1. in the "Enjoying Viewing Your Image on a PC" section on page 17.

2. Connecting your camera to your computer

- 1 Turn on your computer.
- 2 Set the Mode switch on your camera to  .
- 3 Slide the Lens cover on your camera to prepare for capturing images.
- 4 Insert the USB cable to the USB port on your computer.

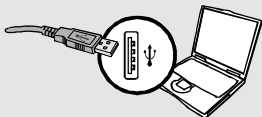

- 5 Insert the other end of the USB cable to the USB port on your camera.





Notice for Windows 2000/ ME/ 98SE users when using PC camera function for the first time

When using PC Camera function (or Video Conferencing) for the first time, please follow the steps below.

■ For Windows 2000 users

The dialog box "Digital Signature Not Found" might appear twice, please simply click "Yes". This camera works well for Windows 2000.

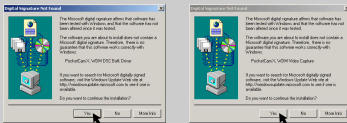

■ For Windows ME users

Please select "Automatic search for a better driver" when a window as Fig 7 appears.



Fig 7

■ For Windows 98SE users

Click "Next" when a window as Fig 8 appears.

→ Select "Search for a best driver for your device" and click "Next" when a window as Fig 9 appears.

→ Select the position where your Windows 98SE driver is. You might be asked to insert the licensed Windows 98SE CD-ROM in your CD-ROM drive.

Follow the on-screen instructions to complete the installation.



Fig 8

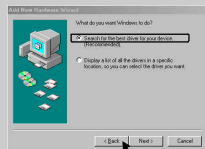
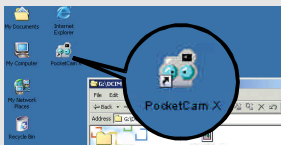

Fig 9

3. Capturing immediate images to your computer

- 1 After the installation of driver and hardware, you can start to use the PC Camera function or run other Video Conferencing applications. (This manual provides information related to PC camera function only.)

Double-click the "PocketCam X" icon on the desktop to execute the program, then you can begin to capture immediate images on your computer.



OR

Click the "Start" menu and go up to "Programs", then go to the folder named "PocketCam X" and click it.



If you want to use Video Conferencing function

Open the NetMeeting interface or other Video Conferencing application and then start to use it.

- ② Press the icon at the bottom on the PC camera panel to use the functions.

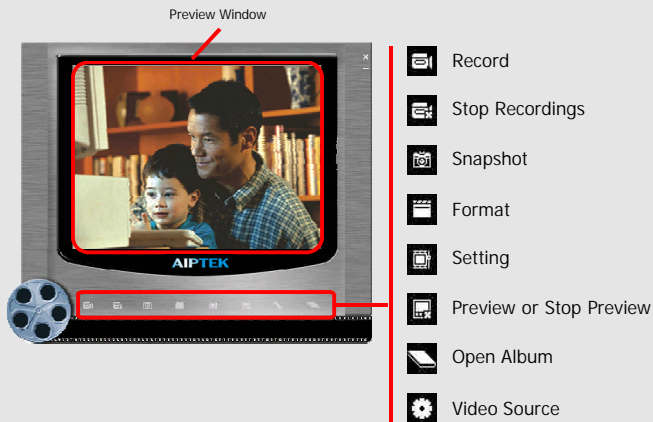

Viewing your pictures and movies with PC camera interface

Click the "Open Album" icon at the bottom on the PC camera panel, or go to the follow path to find the files.

C:\Program Files\PocketCam X\Work Temp

4. Advanced settings

Click the "Format" and "Setting" icon on the PC camera panel to bring up advanced settings.

► Format settings

1 Color Space / Compression

Select one of the following functions according to your needs.

RGB 24: Better image quality.

I420: The file will be compressed to add advantage for faster-speed transformation.

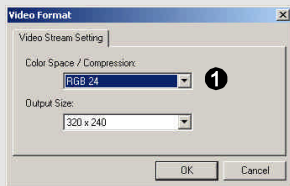

2 Output Size

Set output size to change the size of the preview window. The default size is 320x240. Select larger pixels when you need a larger preview window.

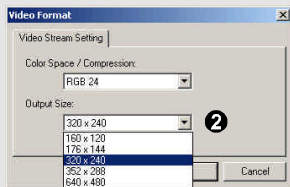

▶ Properties settings

① Video Setting

① Banding Filter

If the screen of your computer flickers when using PC Camera function, change the "Banding Filter" item on the "Video Setting" tab to avoid noise. Select "50Hz" or "60 Hz" until the screen stops flickering. If you want to restore the default setting, select "Normal AE".

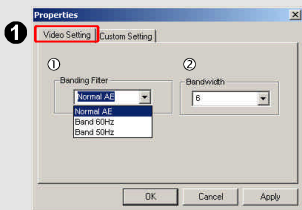





② Bandwidth

If the controller has no enough bandwidth available for the PocketCam X USB camera, select a smaller value in the "Bandwidth" item on the "Video Setting" tab. The smaller the bandwidth value is, the less the bandwidth is occupied.

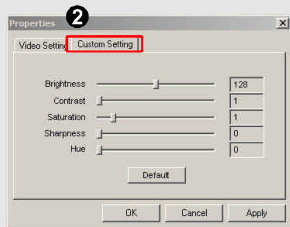
② Custom Setting

You can use the default settings or change the settings of brightness, contrast, saturation, sharpness, and hue on your own.



Question	Answer 
 When using the camera	
<p>The camera has no power.</p>	<ol style="list-style-type: none"> ❶ The batteries may be out of power, please change the batteries. ❷ Make sure that the battery is installed correctly.
<p>Cannot power on my camera even though batteries is installed.</p>	<ol style="list-style-type: none"> ❶ Make sure that the battery is installed correctly. ❷ If it is idle over 3 minutes, the camera will shut down automatically, please press the Power button or slide the Lens cover to power on the camera.
<p>Cannot take pictures and movies when pressing the Shutter button.</p>	<ol style="list-style-type: none"> ❶ Make sure that the Lens cover is open. ❷ The storage is full. Please free some space of the SD/MMC card or flash memory. ❸ Check if the camera is under the status of charging batteries. ❹ Check if the SD/MMC card is set to "protected". ❺ If the "MEMORY ERROR" message shows on the LCD display, please set the Mode switch to  mode format the card.
<p>I did not delete the picture and movie, but cannot find the data in the SD/MMC card.</p>	<p>Check if your files are stored in the  camera's built-in memory. If there is a icon at the right bottom section on the LCD display, it means you are using the camera with a SD/MMC card. Please remove the card to find the data in the flash memory. (For details, see the "Removing the card" section on page 6)</p>
<p>Cannot set the strobe to the "On" mode.</p>	<p>Charging the flash strobe requires more power of batteries. When the battery is under the status of low power, the strobe On cannot be set. Please change the batteries.</p>

The image is too blurred.	Please adjust the focus (see page 8).
The image on is too dark.	You may need to take pictures or movies in the place with adequate light or use the flash strobe.
Sound playback is not available when viewing the movie on the LCD display.	This situation is normal. If you want the movie with sound playback, please copy the movie to your computer and view it on the computer.
Noise occurs on my camera when viewing the image on the LCD display or on the computer.	Set the filter matching the place you are. Please refer to the "More on flicker" section on page 33.
 When connecting the camera to your computer	
The driver installation failed.	<ul style="list-style-type: none"> ❶ Please remove the driver and other related programs. Follow the installation steps in this manual to reinstall. ❷ Install the driver before inserting the USB cable.
A conflict with other installed camera or capture device.	If you have any other camera or capture device, completely remove the camera and its driver from the computer to avoid a driver conflict.
The movie cannot be played on my computer.	Please install DirectX 8.0 or above. (See the "Installing the PocketCam X driver" section on page 17 or download DirectX 8.0 and get more information on Microsoft website.)
Noise occurs on my computer when using Video Conferencing.	Set the filter matching the place you are. Please refer to the "Banding Filter" section on page 29.

1. Life of battery

Condition \ Number	Number of images	Battery life (minutes)
Taking Still Pictures 1600x1200 (without flash strobe)	650	45

* Data above is for using alkaline batteries and in 25°C, with pictures taken every four seconds.

- !** Notes:
- Life of battery will be shorten in the following conditions.
 - Taking snapshot at low temperature.
 - Turn on/off power repeatedly.
 - The table above is for reference only.
 - Using the flash light will decrease the number of pictures to be taken.

2. LED indicator events

Condition	LED color	Meanings
Status (LED indicator)	Red	Busy (mode change, storage, or capture)
	Green	Ready (waiting for command)
Flash (LED indicator)	Red	Charging flash
	Green	Ready (waiting for command)
Data transformation (LED indicator)	Red	Data transformation
	Green	Ready (waiting for command)
Self-Timer (Self-Timer indicator)	Red (regularly)	Counting
	Red (rapidly)	Capturing the picture

- !** Never eject the card or remove the batteries while the LED indicator is lit up red.

3. Storage capacity

Memory	Still picture			Movie
	2048x1536	1600x1200	1280x960	Maximum recording time
Flash memory (16MB)	20	30	48	2
SD/MMC card (32MB)	40	60	96	4
SD/MMC card (64MB)	80	120	192	8
SD/MMC card (128MB)	160	240	384	16
SD/MMC card (256MB)	320	480	768	32
SD/MMC card (512MB)	640	960	1536	64

- !** Notes: 1. Actual number of pictures stored may vary (up to + 30%) depending on the resolution and color saturation.
2. The table above is for reference only.

4. More on flicker

The default flicker setting of your camera is based on your country. When using the camera abroad, please refer to the table below to match the flicker setting with the place you go.

Country	England	Germany	France	Italy	Spain	Netherlands
Setting	50Hz	50Hz	60Hz	50Hz	50Hz	50Hz
Country	Portugal	America	Taiwan	China	Japan	Korea
Setting	50Hz	60Hz	60Hz	50Hz	50/ 60Hz	60Hz

5. Specification

Hardware resolution	2048x1536 (3.1MP)
Sensor effective resolution	1600x1200 (2MP)
Internal memory	Built-in 16MB SDRAM (buffer) 16 MB flash memory (storage)
External memory	Built-in SD/MMC slot (maximum: 512 MB)
Digital still camera	JPEG Format 2048x1536 (3.1MP); 1600x1200 (2MP); 1280x960 (1.3MP)
Digital video camcorder	Motion JPEG (AVI) Format QVGA (320x240 pixels) / up to 20 fps
Video conferencing	VGA (640x480 pixels) / up to 10 fps QVGA (320x240 pixels) / up to 20 fps
LCD display	1.5" Color TFT LCD
Digital zoom	4x (for still pictures only)
Exposure	Auto/Back light
White balance	Auto/Sunny/Cloudy/Fluorescent/Tungsten
Image effect	4 modes for still pictures and 2 modes for videos
Lens	F=3.5, 8.5mm
Self Timer	10 seconds
Interface	USB 1.1 (USB 2.0 compatible)
Power saving	Auto power-off if idle for over 3 minutes
Built-in microphone	Yes
Built-in speakers	No
Built-in flash strobe	Yes
Battery	AAAx2 (alkaline recommended)
Dimension	3.4"x1.6"x1.2"
Package	PocketCam X