

Quick Operation (English)

HITACHI
Inspire the Next

DZ-BD9H

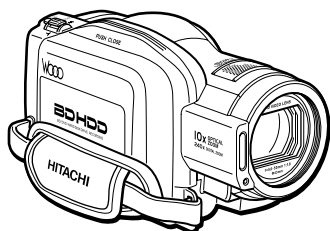

■ Setting up the battery pack

Charging status	CHARGE indicator
During charge	Lit
Charge complete	Unlit

CHARGE indicator

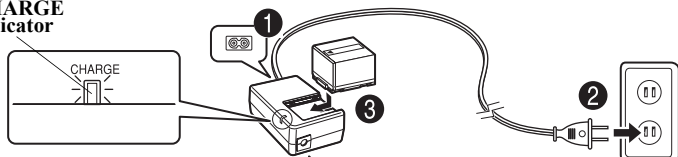

If the CHARGE indicator does not light, check that the connections (1, 2, and 3) are firmly made.

Note
Charging will not occur if the DC power cord is connected.

4 After charging is complete, attach the battery pack to the camcorder.

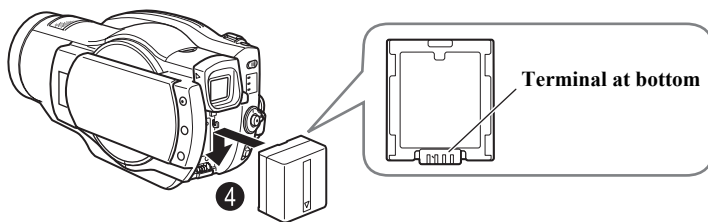

■ Removing the battery pack

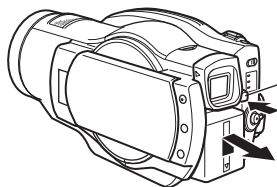

- 1 Always turn the power off before disconnecting the power supply.
- 2 While pressing and holding the BATT switch, slide the battery pack upward, then remove it.
 - Be careful not to drop the battery pack while detaching it.

Turning on the Power

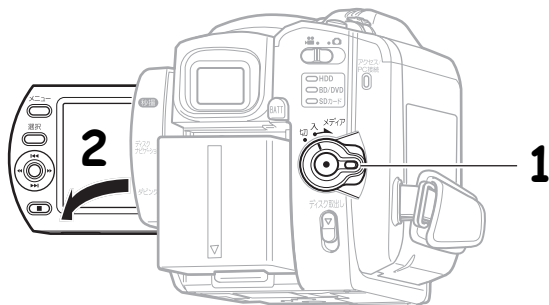

1 Turn on the power.

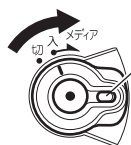

Press and hold the lock button, and turn the power switch to "入".

2 Open the LCD monitor.

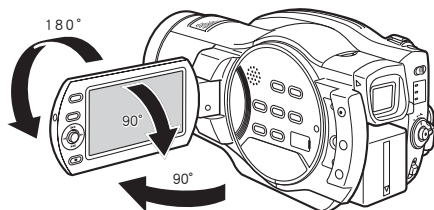

Changing the display language (LANGUAGE)

You can change the language used on screens and menus.
The following shows how to change from Japanese to English.

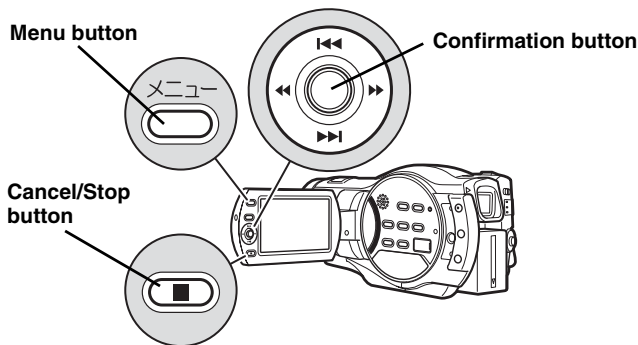

- 1 Press the menu button, then select "初期設定" by pressing **◀◀▶▶**. Then, press **▶▶** (or the confirmation button).

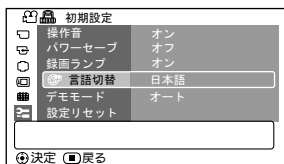

- 2 Select "言語切替" by pressing **◀◀▶▶**, then press **▶▶** (or the confirmation button).

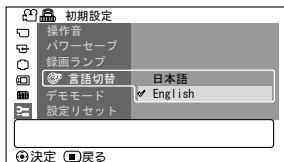

- 3 Select "English" by pressing **▶▶**, then press the confirmation button.

Setting the Date and Time

- 1 Press the menu button, then select "Date Setup" by pressing **◀◀▶▶**. Then, press **▶▶** to select "Date Set" and press **▶▶** again.

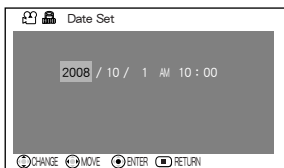

- 2 Select each item by pressing **◀/▶** and set the correct value by pressing **◀◀▶▶**.

- Repeat this step until year, month, date, hour, minute, and AM/PM are correctly set.

- 3 Press the confirmation button. The confirmation screen appears.

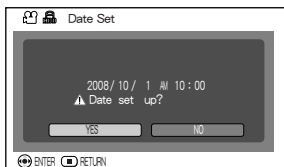

- 4 Press **◀◀** to select "YES", then press the confirmation button to confirm.

- If you select "No" and press **▶▶**, the screen returns to step 2.

Inserting a BD or DVD

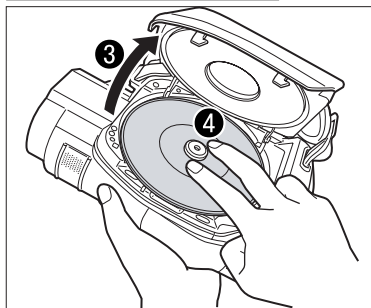
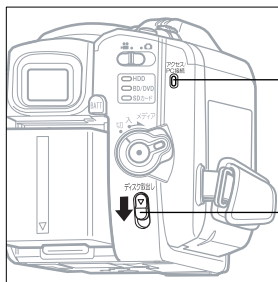

- 1 Attach the charged battery pack to the camcorder, or connect the camcorder to a power outlet.
- 2 Turn the power switch to " 切 ", then press down the disc eject switch until the access/PC indicator lights, then release.
- 3 After several seconds, the lid pops open. Open it fully with your hand.
- 4 Place the recording surface of the BD/DVD face down, then push down on the center of the BD/DVD until it clicks into place.
 - For single-sided discs, the side opposite the label is the recording surface.
 - To record on the other side for double-sided discs, remove the disc (p.6), flip it over, and then reload it.

5 Close the lid.

After the lid is closed all the way, the camcorder will attempt to recognize the BD/DVD. During this recognition process, the access/PC indicator flashes. While this is happening, do not remove the power source, shake the camcorder, or subject it to impact.

6 When a new BD-RE/BD-R/DVD-RW is loaded, the format confirmation screen will appear. See p.6.

Notes

- The disc mechanism may be quite hot immediately after use. Do not touch the metallic areas.
- Do not peer into the pickup. Doing so may cause damage to your eyesight.
- To prevent malfunction, never do any of the following:
 - touch the laser pickup
 - insert a disc that is not compatible with the camcorder
 - close the lid before setting the disc securely into place
- The power automatically turns off if the lid is left open for approx. 3 minutes.
- The lid will not open if the camcorder is not connected to a power source.

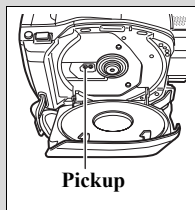
**Removing the BD/DVD**

Pressing slightly on the center hub with a finger, grip the edge of the disc with your thumb and lift the disc out as shown.

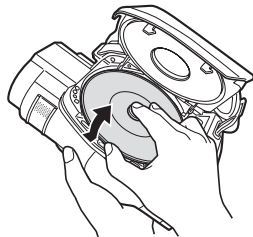
**■ When loading a new BD-RE/BD-R/DVD-RW**

The disc must be formatted before it can be used for recording. When the disc is loaded, the format confirmation screen will appear in the LCD monitor.

① Open the LCD monitor (p.2).

Confirmation button

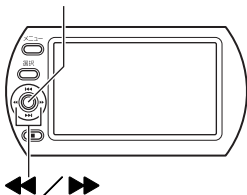
**Note**

Be careful that the power is not accidentally cut off while formatting, otherwise, the disc will become unusable.

- 2 Select "YES" by pressing ◀, then press the confirmation button.

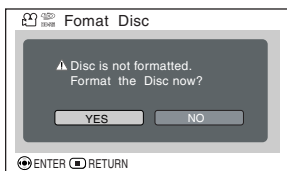

- When using a BD-RE/BD-R, formatting will start. Skip step 3.
- When using a DVD-RW, proceed to step 3.

- 3 (When using a DVD-RW)

The recording format selection screen appears.

Select "VR Mode" or "VF Mode" by pressing ◀▶▶, then press the confirmation button.

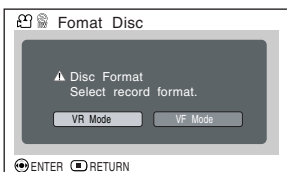

VR Mode

After recording, you can perform various editing functions, such as choosing or deleting scenes. You can play back the disc in a device that supports an 8cm DVD-RW (VR Mode) after finalizing the disc.

VF (Video) Mode

Although editing cannot be done on the camcorder, you can play back the disc on other DVD devices after finalizing the disc.

Inserting and Removing Card

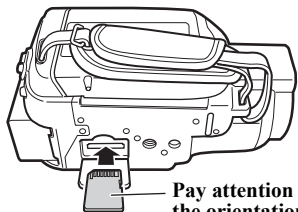

The terminals should face away from the LCD monitor.

- 1 Always turn off the power before inserting a card.
- 2 Open the cover.
- 3 Push the card in until it clicks into place.

(To remove the card, push it in slightly and release. The card will pop up, and you can remove it.)

- 4 Always close the cover.

Recording Movies

You can choose either HDD or BD/DVD to record movies.

1 Slide the Movie/Stills switch to "🎥".

2 Open the LCD monitor.

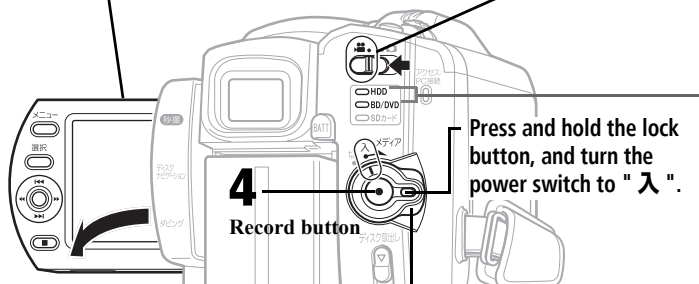

Press and hold the lock button, and turn the power switch to "入".

3 Turn the power switch to "入".

The HDD indicator lights and the camcorder enters recording pause mode. Movies will be recorded to HDD.

To switch between HDD and BD/DVD, turn the power switch to "メディア" and release the switch.

- The power switch will return to "入" automatically. Each time you turn the switch to "メディア", the active function will alternate as follows: HDD indicator lights ↔ BD/DVD indicator lights.
- Switch to "切", to turn off.

4 Press the record button.

- "●II" (recording pause) in the LCD monitor will change to "●REC" and recording will begin. The recording indicator beneath the lens will also light up red.
- To pause recording, press the record button again. The elapsed recording time will reset to "0:00:00".
- To resume recording, press the record button again.

Elapsed recording time
(hrs : mins : secs)

Remaining space on
HDD/BD/DVD/Card

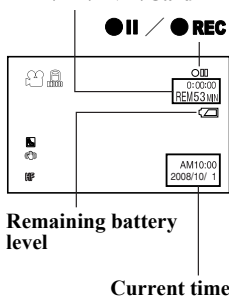

Recording Still Pictures

Still pictures are recorded on an SD memory Card.

1 Slide the Movie/Stills switch to "📷".

2 Open the LCD monitor.

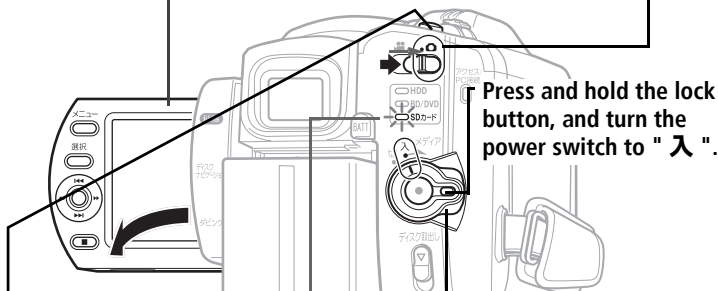

3 Turn the power switch to "入".

- The SD card indicator lights.
- Switch to "切", to turn off.

4 Press the "フォト" (photo) button halfway down.

A subject in the center of the screen will be focused. When focus is locked, the green "●" in the LCD monitor will turn purple.

5 Fully press the "フォト" (photo) button.

The image will be recorded. After a few seconds, the image shot will be displayed for about three seconds. You can shoot the next photo when "●" changes back to green.

Playback

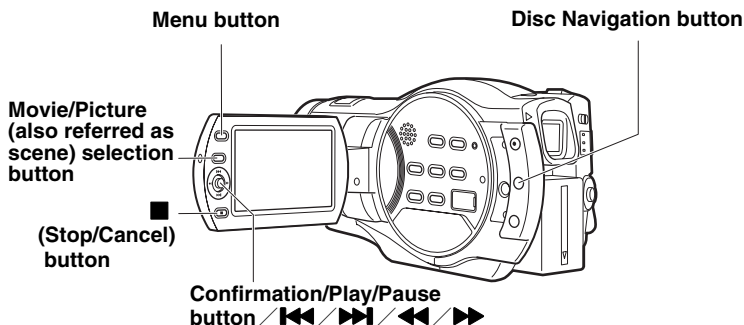

HDD BD-RE BD-R RAM RW (VR) RW (VF) R CARD

■ Choosing and playing back a scene

- 1 Press the Disc Navigation button while the media you want to play back is in recording pause mode.
The scenes thumbnails appear on the disc navigation screen.
- 2 Choose a scene by pressing (up/down, previous page/following page) and (left/right).
- 3 Press the confirmation button.
The chosen scene is played back.
 - To promptly return to the disc navigation screen, press or the Disc Navigation button. To return to recording pause mode, press or the Disc Navigation button again.

HDD BD-RE BD-R RAM RW (VR) RW (VF) R

■ Adjusting speaker volume during movie playback

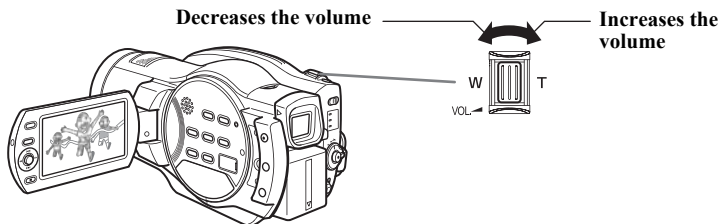

Useful Recording Techniques

HDD BD-RE BD-R RAM RW (VR) RW (VF) R CARD

Magnified Recording (Optical Zoom and Digital Zoom)

The zoom lever allows you to choose a range of magnifications from wide-angle to telephoto zooming.

Optical zooming up to ten times is the maximum telephoto magnification.

When using a card (recording stills), only optical zoom works.

Maximum zoom values will depend on the "Digital Zoom" settings.

off → 40 × → 240 ×



W:Wide-angle
(Shooting over a wide range)



T:Telephoto
(Magnifies shooting)

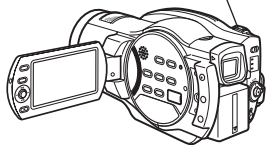

HDD BD-RE BD-R RAM RW (VR) RW (VF) R CARD

Selecting a Shooting Mode to Match the Conditions (Program AE)

The camcorder automatically gauges the subject and surrounding conditions and determines the optimal settings for recording (Auto). You can also select a shooting mode that may better suit the situation.

Shooting mode

Auto (No icon appears.)



Portrait

Makes the subject, such as a person or pet, stand out from a blurred background.



Spotlight

Prevents overexposure of the subject in strong light, such as at a wedding or on stage.



Sand&Snow

Prevents underexposure of the subject in very bright conditions, such as at the beach, or on a ski slope.



Low Light

Allows you to record in dark places with limited light. You can use the LCD monitor as a light source to shoot the scene by turning the LCD monitor 180°.

Selecting a shooting mode

1 During record pause, press the menu button.

2 Select "Camera Functions Setup" ▶ "Program AE" ▶ a shooting mode.

3 Press the confirmation button to confirm, then the menu button to end.

The selected shooting mode (other than Auto) appears in the LCD monitor.

- The shooting mode is retained in memory even when the power is turned off.

Note

When shooting in dark places, after-images may appear if the subject is moving or if camera shake occurs. Use a tripod for best results.

HDD BD-RE BD-R RAM RW(VRI) RW(VF) R CARD

Restoring all the Shooting Settings to Default (Full Auto)

You can reset the following manually adjusted shooting settings to their defaults with the press of a single button.

Function	Default
Focus	Auto
Exposure	Auto
BLC (Backlight)	Off
Program AE (shooting mode)	Auto
White Balance	Auto
EIS (Electronic Image Stabilizer)	On
Microphone Filter	Off

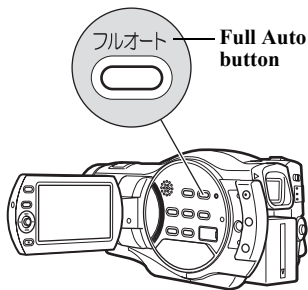

1 During record pause or recording, press the Full Auto button.
"FULL AUTO" appears in the LCD monitor for a moment and the settings return to their defaults.