

# SHARP®

LIQUID CRYSTAL DISPLAY CAMCORDER

MODEL

## VL-AH130U

■ OPERATION MANUAL ■

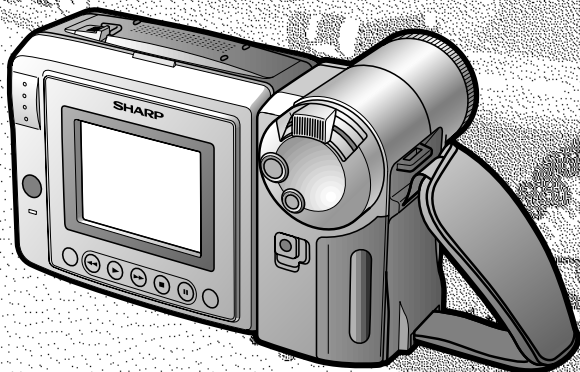

# SHARP VIEWCAM

**Hi 8** NTSC

Please read this operation manual carefully before using the VIEWCAM.

### Important

For assistance in reporting the theft or loss of this product, record on the line below the model number and serial number which are located on the bottom of the unit. Please retain this information.

Model No.:

Serial No.:

• See page 54 for use of Demo mode.

Operation Summary

Preparation

Basic Operations  
Camera Recording

Basic Operations  
Playback

Useful Features

Advanced Features

References

Thank you for purchasing this VIEWCAM from SHARP.  
The VIEWCAM will enhance your home video enjoyment and allow you to capture those special moments. Please read this operation manual to familiarize yourself with the VIEWCAM's features, so that you will get the most out of it. The video techniques section will help you fully enjoy the many features this VIEWCAM offers, and expand your video world.

## Important Information for Consumers in the U.S.

**WARNING: TO REDUCE THE RISK OF FIRE OR ELECTRIC SHOCK, DO NOT EXPOSE THIS APPLIANCE TO RAIN OR MOISTURE.**



**CAUTION:**  
TO REDUCE THE RISK OF ELECTRIC SHOCK, DO NOT REMOVE COVER. NO USER-SERVICEABLE PARTS INSIDE. REFER SERVICING TO QUALIFIED SERVICE PERSONNEL.

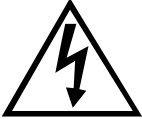

This symbol warns the user of uninsulated voltage within the unit that can cause dangerous electric shocks.



This symbol alerts the user that there are important operating and maintenance instructions in the literature accompanying this unit.

### CAUTION

**(applies to the supplied AC adapter)**

TO PREVENT ELECTRIC SHOCK, MATCH WIDE BLADE OF PLUG TO WIDE SLOT, FULLY INSERT.

### CAUTION

If the AC adapter is misplaced or needs to be replaced, obtain the same type of adapter from a SHARP service center of your dealer.

### PRODUCT DISPOSAL

This Product utilizes tin-lead solder, and a fluorescent lamp containing a small amount of mercury. Disposal of these materials may be regulated due to environmental considerations. For disposal or recycling information, please contact your local authorities or the Electronics Industries Alliance: [www.eiae.org](http://www.eiae.org).

### BATTERY DISPOSAL

CONTAINS NICKEL-METAL HYDRIDE RECHARGEABLE BATTERY. MUST BE RECYCLED OR DISPOSED OF PROPERLY. CONTACT LOCAL AGENCIES FOR INFORMATION ON RECYCLING AND DISPOSAL PLANS IN YOUR AREA.

**WARNING**—FCC Regulations state that any unauthorized changes or modifications to this equipment not expressly approved by the manufacturer could void the user's authority to operate this equipment.

This device complies with Part 15 of the FCC Rules. Operation is subject to the following two conditions: (1) This device may not cause harmful interference, and (2) this device must accept any interference received, including interference that may cause undesired operation.

### **INFORMATION**

This equipment has been tested and found to comply with the limits for a Class B digital device, pursuant to Part 15 of the FCC Rules. These limits are designed to provide reasonable protection against harmful interference in a residential installation. This equipment generates, uses, and can radiate radio frequency energy and, if not installed and used in accordance with the instructions, may cause harmful interference to radio communications. However, there is no guarantee that interference will not occur in a particular installation. If this equipment does cause harmful interference to radio or television reception, which can be determined by turning the equipment off and on, the user is encouraged to try to correct the interference by one or more of the following measures:

- Reorient or relocate the receiving antenna.
- Increase the separation between the equipment and receiver.
- Connect the equipment into an outlet on a circuit different from that to which the receiver is connected.
- Consult the dealer or an experienced radio/TV technician for help.

### **CAUTION ON LITHIUM BATTERY (MEMORY BACKUP BATTERY)**

If a battery is reversed (positive end where the negative end belongs and vice versa), it can overheat and rupture. This has happened when young children install batteries backwards. Warn children *not* to take out batteries or install them. *Parents should install the lithium battery in the VIEWCAM.*

Your VIEWCAM is designed to record in SP mode only. It will not perform normal playback for programs prerecorded in LP mode.

This VIEWCAM does not have a PCM recording or playback function. PCM recordings made using other VCRs or audio dubbing cannot be played back on this unit.

If you record on a tape on which PCM sound has already been recorded, the audio track of the new VIEWCAM recording may not come out if the tape is played back on a PCM-capable VCR. If this occurs, set the VCR's audio monitor select switch to the "STANDARD" position.

**COPYRIGHT WARNING:** It is the intent of SHARP that this unit be used in full compliance with the copyright laws of the United States and that prior permission be obtained from copyright owners whenever necessary.

### **NOTE**

The VIEWCAM's LCD panel is a very high technology product with close to 90,000 thin-film transistors\*, giving you fine picture detail. Occasionally, a pixel may appear on the screen as a fixed point of blue, green, red, or black. Please note that this does not affect your VIEWCAM's performance.

\*Specifications are subject to change without notice.

# IMPORTANT SAFEGUARDS

1. Read Instructions—All the safety and operating instructions should be read before the product is operated.
2. Retain Instructions—The safety and operating instructions should be retained for future reference.
3. Heed Warnings—All warnings on the product and in the operating instructions should be adhered to.
4. Follow Instructions—All operating and use instructions should be followed.
5. Cleaning—Unplug this product from the wall outlet before cleaning. Do not use liquid cleaners or aerosol cleaners. Use a damp cloth for cleaning.
6. Attachments—Do not use attachments not recommended by the product manufacturer as they may cause hazards.
7. Water and Moisture—Do not use this product near water—for example, near a bath tub, wash bowl, kitchen sink, or laundry tub; in a wet basement; or near a swimming pool; and the like.
8. Accessories—Do not place this product on an unstable cart, stand, tripod, bracket, or table.

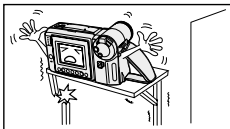

adult, and serious damage to the product. Use only with a cart, stand, tripod, bracket,

or table recommended by the manufacturer, or sold with the product. Any mounting of the product should follow the manufacturer's instructions, and should use a mounting accessory recommended by the manufacturer.

9. A product and cart combination should be moved with care. Quick stops, excessive force, and uneven surfaces may cause the product and cart combination to overturn.



10. Ventilation—Slots and openings in the cabinet are provided for ventilation and to ensure reliable operation of the product and to protect it from overheating, and these openings must not be blocked or covered. The openings should never be blocked by placing the

product on a bed, sofa, rug, or other similar surface. This product should not be placed in a built-in installation such

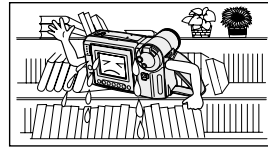

as a bookcase or rack unless proper ventilation is

provided or the manufacturer's instructions have been adhered to.

11. Power Sources—This product should be operated only from the type of power source indicated on the marking label. If you are not sure of the type of power supply to your home, consult your product dealer or local power company. For products intended to operate from battery power, or other sources, refer to the operating instructions.
12. Grounding or Polarization—This product may be equipped with a polarized alternating-current line plug (a plug having one blade wider than the other). This plug will fit into the power outlet only one way. This is a safety feature. If you are unable to insert the plug fully into the outlet, try reversing the plug. If the plug should still fail to fit, contact your electrician to replace your obsolete outlet. Do not defeat the safety purpose of the polarized plug.
13. Power-Cord Protection—Power-supply cords should be routed so that they are not likely to be walked on or pinched by items placed upon or against them, paying particular attention to cords at plugs, convenience receptacles, and the point where they exit from the product.
14. Lightning—For added protection for this product during a lightning storm, or when it is left unattended and unused for long periods of time, unplug it from the wall outlet and disconnect the antenna or cable system. This will prevent damage to the product due to lightning and power-line surges.

- 
15. Power Lines—An outside antenna system should not be located in the vicinity of overhead power lines or other electric light or power circuits, or where it can fall into such power lines or circuits. When installing an outside antenna system, extreme care should be taken to keep from touching such power lines or circuits as contact with them might be fatal.
  16. Overloading—Do not overload wall outlets, extension cords, or integral convenience receptacles as this can result in a risk of fire or electric shock.
  17. Object and Liquid Entry—Never push objects of any kind into this product

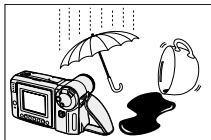

through openings as they may touch dangerous voltage points or short-out parts that could result in a fire or electric shock. Never spill liquid of any kind on the product.

18. Servicing—Do not attempt to service this product yourself as opening or removing covers may expose you to dangerous voltage or other hazards. Refer all servicing to qualified service personnel.
19. Damage Requiring Service—Unplug this product from the wall outlet and refer servicing to qualified service personnel under the following conditions:
  - a. When the power-supply cord or plug is damaged,
  - b. If liquid has been spilled, or objects have fallen into the product,
  - c. If the product has been exposed to rain or water,
  - d. If the product does not operate normally by following the operating instructions. Adjust only those controls that are covered by the operating instructions as an improper adjustment of other controls may result in damage and will often require extensive work by a qualified technician to restore the product to its normal operation,
  - e. If the product has been dropped or damaged in any way, and

- f. When the product exhibits a distinct change in performance—this indicates a need for service.
20. Replacement Parts—When replacement parts are required, be sure the service technician has used replacement parts specified by the manufacturer or have the same characteristics as the original part. Unauthorized substitutions may result in fire, electric shock, or other hazards.
21. Safety Check—Upon completion of any service or repairs to this product, ask the service technician to perform safety checks to determine that the product is in proper operating condition.
22. Wall or Ceiling Mounting—The product should be mounted to a wall or ceiling only as recommended by the manufacturer.
23. Heat—The product should be situated away from heat sources such as radiators, heat registers, stoves, or other products (including amplifiers) that produce heat.

# Precautions

- **When the VIEWCAM is not in use, remember to remove the cassette tape, turn off the power, and disconnect the VIEWCAM from the power source.**

- **Do not aim the lens at the sun.**  
Do not allow direct sunlight to strike the VIEWCAM lens or LCD monitor screen, whether or not recording is in progress, as it may damage the CCD sensor or LCD screen surface. Be particularly careful when recording outside.

- When shooting in dark places, avoid sudden brightly lit objects or light sources, such as the sun. Otherwise, the image may white out. Should this happen, point the lens in a different direction until the picture returns to normal.

- **Avoid magnetic sources.**

Using the VIEWCAM near strong fluorescent lights, motors, televisions, or other magnetic sources may adversely affect recorded images.



- **Using the VIEWCAM near a broadcasting station or other powerful transmission source may cause buzzing or picture deterioration.**

- **Avoid shocks and dropping.**

Do not drop or otherwise subject the VIEWCAM to hard shocks or strong vibrations. Bumping or striking the unit during recording will generate noise in the recorded image.

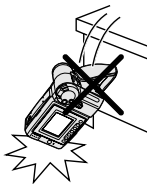

- **Avoid placing the VIEWCAM in close proximity to lighting equipment.**

The heat from incandescent lights may deform the VIEWCAM, or cause it to malfunction.

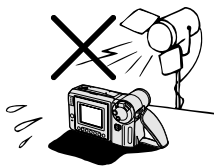

- **Always respect prohibitions or restrictions on the use of electronic equipment on commercial flights or in other sensitive areas.**

- **Be aware of the temperature and humidity.**  
You can use your VIEWCAM at 0°C to +40°C (32°F to 104°F), and at 30% to 80% relative humidity. Do not store the unit in an unventilated car in the summer, in direct sunlight, or near strong heat sources; this can result in severe damage to the unit casing and circuitry.



- **Avoid situations where water, sand, dust or other foreign matter could get on or inside the VIEWCAM, and do not use or leave your VIEWCAM in areas with excessive smoke, steam or moisture.**

Such environments can cause malfunctions or cause mildew to form on the lenses. Be sure to keep the unit in a well-ventilated location.

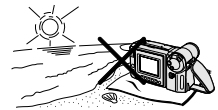

- **Some small, portable tripods may be difficult to attach and may not be sturdy enough to support your VIEWCAM. Be sure to use only a strong, stable tripod.**



- **When using your VIEWCAM in a cold environment, the LCD monitor screen often appears less bright immediately after the power is turned on. This is not a malfunction. To prevent the VIEWCAM from becoming too cold, wrap it in a thick cloth (a blanket, etc.).**

# About Your VIEWCAM

---

## Hi8 Recording Format

Hi8 is a high-performance extension of the ordinary 8 mm format. It uses advanced technology to achieve even higher resolution and picture quality. Use a video cassette with the **Hi8** mark for high-quality recording and playback, or with the **8** mark to enjoy ordinary 8 mm recording and playback.

- When you load a Hi8 tape, recording is in Hi8 format. (The **Hi8** indicator appears on the LCD screen.) When you load a normal 8 mm tape, recording is in ordinary 8 mm format. (The **Hi8** indicator does not appear.)
- During playback, the recorded format is automatically detected.
- Video equipment not for use with Hi8 is unable to play back a tape recorded in Hi8 format.
- If you want to record with a Hi8 tape in normal 8 mm format, set the **Hi8** menu item to "OFF" on the **5/3** (MENU 1) screen (Camera mode) before recording. (See page 25 for operation of the menu screen.)

## LCD Monitor Screen

The VIEWCAM is equipped with a large LCD monitor screen that allows you to record scenes while comfortably holding the camcorder. The LCD monitor screen can be rotated for easy recording at high or low angles. It also functions as a handy playback monitor so you can enjoy what you have just recorded.







### Cautions:

- Do not apply pressure to the screen.
- Do not expose the screen to shocks, as it may break.
- Do not place the VIEWCAM with the screen facing down.

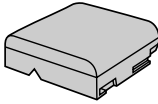
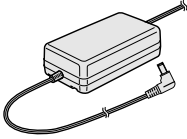
### Note:

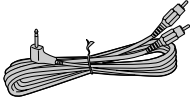
- Use a soft cloth to clean the screen.

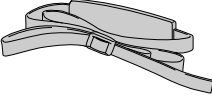
# Supplied Accessories

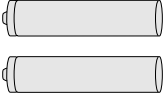
 <p>Battery pack *BT-H22□</p>	 <p>AC adapter *UADP-0312TAZZ</p>	 <p>Infrared remote control RRMCG0084TASA</p>	 <p>Audio/video cable QCNW-1448TAZZ or QCNW-1295TAZZ</p>
 <p>CR2025 type lithium battery</p>	 <p>Shoulder strap UBNDS0010TASA</p>	 <p>Lens cap GCOVH1225TASA</p>	 <p>AA battery for remote control × 2</p>

\* **Note:** The part numbers for the AC adapter and battery pack supplied with this VIEWCAM are valid only in the U.S. and Latin America. If this VIEWCAM was purchased outside of these areas, the part numbers may be different. Please refer to the part numbers printed on the labels of the supplied AC adapter and battery pack.



# Optional Accessories

---

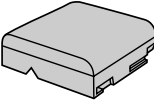
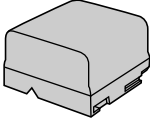
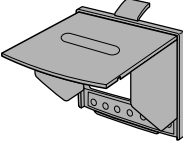
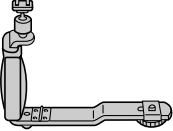
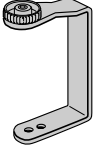
 <p>Standard type battery pack BT-H22☒</p>	 <p>Extended type battery pack BT-H32☒</p>	 <p>Sun hood VR-60BFN</p>	 <p>Accessory shoe adapter VR-30ADN</p>
 <p>Tripod adapter for 180° recording VR-33FAN</p>			

**Note:** The listed model names are for U.S. accessories.

**For optional and additional accessories, contact your local dealer, call the Sharp Accessories and Supply Center at 1-800-642-2122, or visit SHARP's website (<http://www.sharp-usa.com>).**

# Contents

---

<b><u>Operation Summary</u></b>	Part Names .....	3
	Quick Reference Index .....	5
	Warning Indicators .....	6

<b><u>Preparation</u></b>	Inserting and Removing the Battery Pack .....	7
	Charging the Battery Pack .....	8
	Powering the VIEWCAM from an AC Outlet .....	9
	Inserting and Removing a Cassette .....	10
	Installing the Lithium Memory Battery .....	11
	Selecting the Language for the On-screen Display .....	12
	Setting the Date and Time .....	16
	Using the Hand Strap and the Lens Cap .....	17
	Attaching the Shoulder Strap .....	17

<b><u>Basic Operations</u></b>	<b>Camera Recording</b>	
	Easy Camera Recording with Full Auto Mode ...	18
	Zooming .....	19
	Tips on Recording Positions .....	19
	Remaining Recording Time Display .....	20
	Remaining Battery Power Display .....	20
	<b>Playback</b>	
	Playback .....	21
	Volume Control .....	21
	Watching the Playback on a TV .....	22
	Video Search .....	23
	Still .....	23
	Slow .....	23

**Useful Features**

Operations of the On-screen Controls	
Using the Control Buttons .....	24
Selecting the Mode/Menu Screens .....	24
Adjusting the Menu Settings .....	25
Recording the Date and Time .....	26
Fade In and Fade Out .....	27
Quick Review .....	28
Quick Return .....	29
Edit Search .....	29
Gamma Brightness Compensation .....	30
Gain-up (Cat's Eye) .....	31
Wide Screen (16:9) .....	32
Macro Shots .....	32
Removing the Lens Hood .....	32
Self Recording .....	33
Setting the VIEWCAM to Full Auto Mode .....	35
Program Search .....	36
Tape Counter Feature .....	37
Using the Remote Control .....	39

**Advanced Features**

Digital Picture Effects .....	40
Scene Menu (Program AE) .....	41
Superimposing a Title .....	42
Changing the Preset Titles .....	43
Auto/Manual Focus .....	44
White Balance Lock .....	45
Manual Exposure .....	46
Picture/Backlight Adjustments .....	47
Gamma Playback .....	48
Turning Off the LCD Monitor Backlight .....	48
Editing .....	49

**References**

Useful Information .....	50
Demonstration Mode .....	54
Before Requesting Service .....	55
Specifications .....	57

• Guía de operación rápida en español .....	58
---	----

# Operation Summary

## Part Names

For details on the use of each part, refer to the page number indicated in the brackets.

### Front view

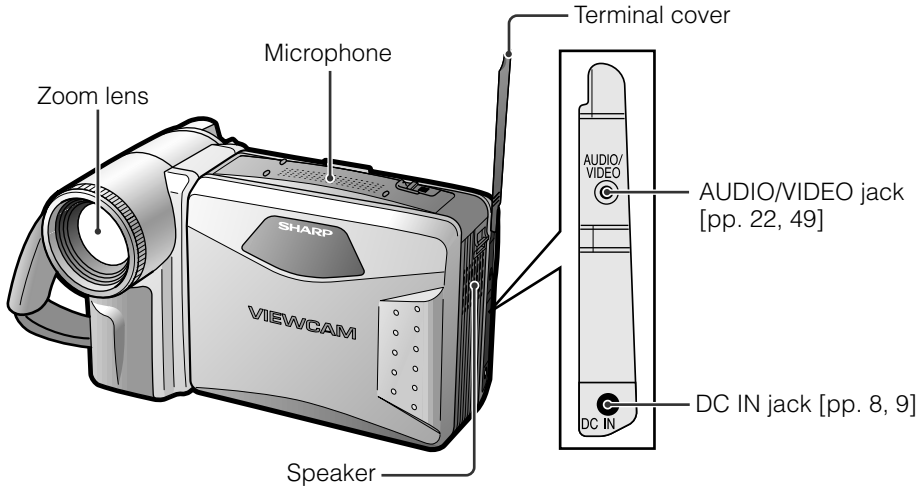

### When the cassette compartment door is open

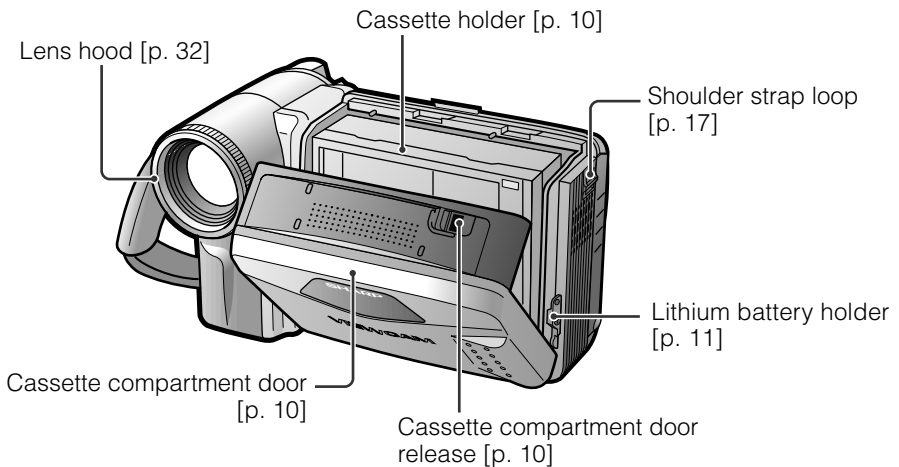

## Rear view

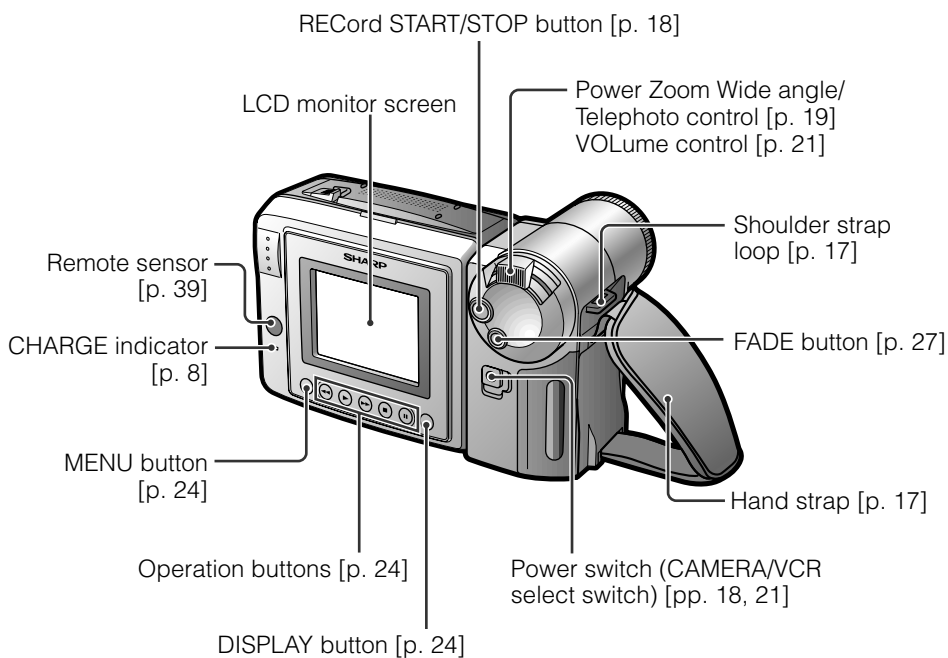

## Bottom view

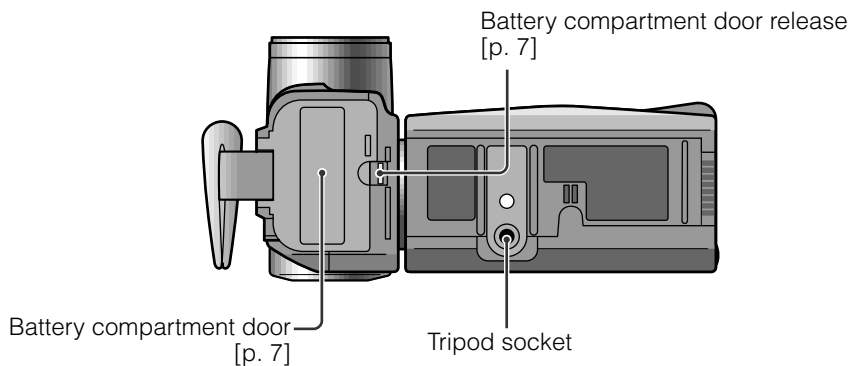

## Operation Summary

---

### Quick Reference Index

This index lists some example uses of the VIEWCAM's features.

- To record with a Hi8 tape in normal 8 mm format.  
—See page vi (**Hi8** Recording Format)
- To quickly check what you have just recorded.  
—See page 28 (Quick Review)
- To quickly return the tape to the end of the last recorded scene after playback.  
—See page 29 (Quick Return)
- To locate the point on the tape where to begin recording while in Camera mode.  
—See page 29 (Edit Search)
- To record a backlit subject.  
—See page 30 (Gamma Brightness Compensation) or page 46 (Manual Exposure)
- To record in a dark or poorly-illuminated location.  
—See page 31 (Gain-up)
- To record yourself while monitoring the shot.  
—See page 33 (Self Recording)
- To record a short video message for somebody.  
—See page 34 (Self-recording Message)
- To find the beginning of a recorded scene to be played back.  
—See page 36 (Program Search)
- To display the elapsed recording or playback time.  
—See page 37 (Tape Counter Feature)
- To focus on an off-centered subject.  
—See page 44 (Manual Focus)
- To increase the brightness of the subject during playback.  
—See page 48 (Gamma Playback)

## Warning Indicators

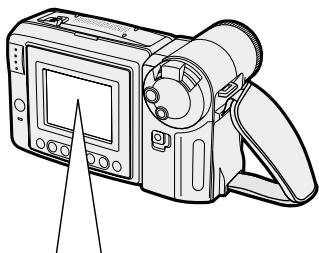

Displayed for the first 3 seconds	Displayed after 3 seconds	Description of warning
EJECT THE CASSETTE.	EJECT THE CASSETTE.	The video cassette is defective and should be removed (see page 10).
DEW	-DEW-	Dew has formed inside the VIEWCAM. Wait for a few hours until the dew disappears (see page 51). About 10 seconds after this warning appears, the VIEWCAM automatically turns off.
BATTERY IS TOO LOW.	-BATTERY-	The battery is almost depleted. Replace it with a fully charged battery pack (see page 7).
✘	✘	The video heads are clogged and should be cleaned (see page 51).
INSERT A CASSETTE.	-CASSETTE-	There is no video cassette in the VIEWCAM. Insert a cassette (see page 10).
CASSETTE NOT RECORDABLE.	-PROTECT. TAB-	The erasure protect tab on the video cassette has been slid to the record-protect position, preventing recording (see page 53).
THE TAPE ENDS SOON.	-TAPE END-	The tape is about to end. Prepare a new cassette (see page 10).
CHANGE THE CASSETTE.	TAPE END	The tape has reached the end. Replace it with a new cassette (see page 10).
◇	◇	In Self Recording mode, all warnings will be indicated by ◇ displayed in the center of the monitor. To check the type of warning, rotate the monitor back to the normal position.

**Note:** ✘ indicates a flashing display.

# Preparation

## Inserting and Removing the Battery Pack

### Inserting the Battery Pack

- 1 Make sure that the Power switch is set to OFF.

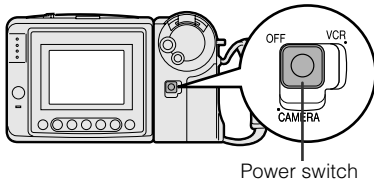

- 2 Slide the battery compartment door release on the bottom of the VIEWCAM in the direction of the arrow to open the battery compartment door.

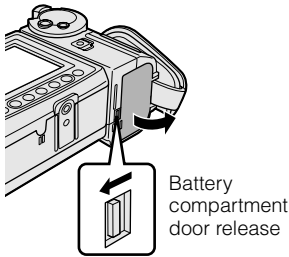

- 3 Insert the battery pack into the compartment as shown, and push it in completely until it locks into place.

#### Caution:

- Do not force the battery pack into the battery compartment if it does not go in easily.

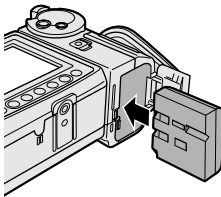

- 4 Close the door, pressing it firmly in the center until it clicks.

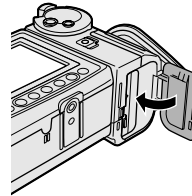

### Removing the Battery Pack

- 1 Perform steps 1 and 2 above.
- 2 Press the battery release as shown to remove the battery pack.

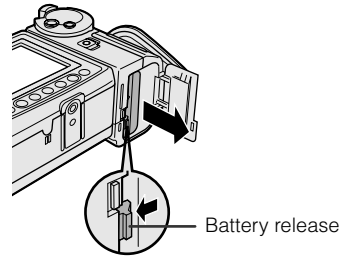

#### Cautions:

- **BEFORE REMOVING THE BATTERY PACK, ALWAYS STOP THE TAPE AND TURN THE POWER OFF.** If you remove the battery pack during recording or playback, the tape will remain wound around the video head drum, potentially causing damage to the tape.
- Make sure the battery compartment door is closed firmly during operation. If it is not, the battery pack may fall out or VIEWCAM operation may fail because of the poor contact pressure.
- Remove the battery pack from the VIEWCAM if the VIEWCAM will not be used for a long period of time.
- **When removing the battery pack, do not tilt the VIEWCAM so that the battery compartment faces down. The battery pack may fall out.**
- Do not expose the battery compartment door to strong force, as it may come off.
- Use only SHARP model BT-H22 or BT-H32 battery packs with this VIEWCAM. Use of other batteries may present a risk of fire or explosion.



## Charging the Battery Pack

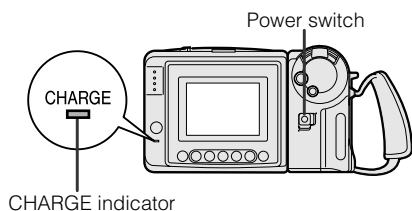

- 1 Insert the battery pack into the VIEWCAM (see page 7). Make sure that the Power switch is set to OFF.
  - The battery pack will not charge when the Power switch is set to CAMERA or VCR.
- 2 Insert the AC plug of the AC adapter into a power outlet.
- 3 Open the terminal cover on the VIEWCAM and insert the DC plug of the AC adapter into the DC IN jack on the VIEWCAM.
  - The CHARGE indicator will light up in red.

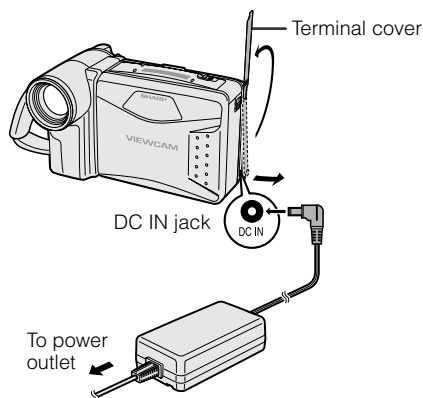

- 4 When the battery is fully charged, the CHARGE indicator will light up in green. Remove the DC plug from the VIEWCAM, and close the terminal cover.

### Caution:

- When removing the plugs, grasp the plug, not the cable.

## Charging time and maximum continuous recording and playback times

Battery pack	Charging time	Max. continuous recording time	Max. continuous playback time
BT-H22	approx. 3 hr.	approx. 1 hr. 35 min.	approx. 1 hr. 35 min.
BT-H32	approx. 6 hr.	approx. 3 hr. 10 min.	approx. 3 hr. 10 min.

### Notes:

- Using the zoom (see page 19) and other functions or turning the power on and off frequently will increase power consumption. This may result in a decrease of more than 50% in the actual recording time compared to the maximum continuous recording time listed above.
- The charging time and recording time may vary depending on the ambient temperature and the condition of the battery pack.
- It is recommended that you have enough battery packs on hand to provide two to three times your estimated recording time.
- See page 52 for more information on using the battery pack.

### Caution:

- Charge only SHARP model BT-H22 or BT-H32 battery packs. Other types of battery packs may burst, causing personal injury and damage.

## Preparation

### Powering the VIEWCAM from an AC Outlet

#### Caution:

- The supplied AC adapter is specially designed for use with this VIEWCAM, and should not be used as a power supply for other camcorders.

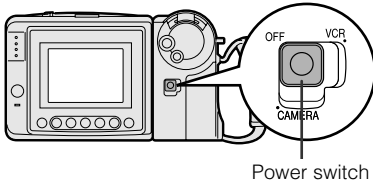

#### Cautions:

- **BEFORE REMOVING THE DC PLUG, ALWAYS STOP THE TAPE AND TURN THE POWER OFF.** If you remove the DC plug during recording or playback, the tape will remain wound around the video head drum, potentially causing damage to the tape.
- Remove the DC plug from the VIEWCAM if you will not use the VIEWCAM for a long period of time.
- When removing the plugs, grasp the plug, not the cable.

#### Note:

- Close the terminal cover after use.

- 1 Insert the AC plug of the AC adapter into a power outlet.
- 2 Make sure that the Power switch is set to OFF.
- 3 Open the terminal cover and insert the DC plug of the AC adapter into the DC IN jack on the VIEWCAM.

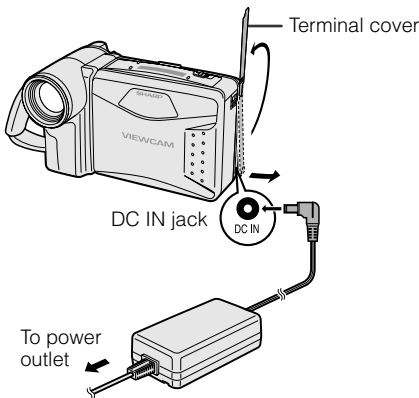

- 4 Hold down the Lock button and slide the Power switch to CAMERA or VCR.

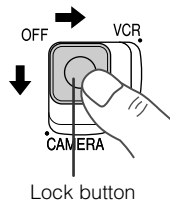

## Inserting and Removing a Cassette

### Inserting a Cassette

- 1 Supply power to the VIEWCAM, then slide the release and open the cassette compartment door.
  - The cassette holder extends and opens automatically.

Cassette compartment door release

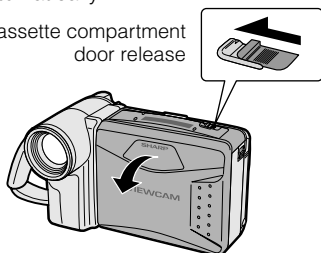

- 2 Insert the cassette fully with the window facing outwards, and with the erasure protect tab facing upwards.

Erasure protect tab

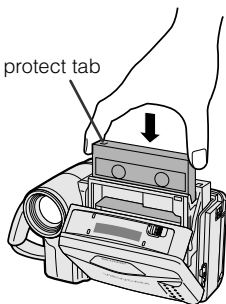

- 3 Press the PUSH mark gently until the cassette holder clicks into place.
  - The cassette holder retracts automatically.

PUSH mark

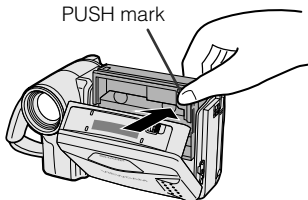

- 4 Wait for the cassette holder to fully retract. Close the compartment door by pressing the center until it clicks into place.

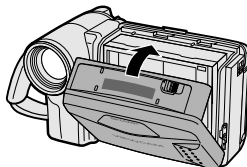

### Removing a Cassette

Perform step 1 above, then take out the cassette.

#### Cautions:

- Do not try to close the cassette compartment door while the cassette holder is extending or retracting.
- Be careful not to get your fingers caught in the cassette holder.
- Do not apply force to the cassette holder except when pressing the PUSH mark to close it.
- Do not tilt the VIEWCAM or hold it upside down when you are inserting or removing a cassette. It may damage the tape.
- Remove the cassette if you will not use the VIEWCAM for a long period of time.
- If you do not correctly close the cassette holder in step 3, the VIEWCAM's cassette protection mechanism might eject the cassette. If this happens, repeat the insertion procedure.
- Do not attempt to pick up the VIEWCAM by the cassette compartment door.

#### Notes:

- If the battery power is too low, you may not be able to eject the cassette. Replace the battery pack with a fully charged one.
- See page 53 for more information on the video cassette tapes for use with this VIEWCAM.

## Preparation

### Installing the Lithium Memory Battery

The supplied lithium battery is used to store the memory of the date and time settings.

- 1 Slide the cassette compartment door release and open the cassette compartment door.

Cassette compartment door release

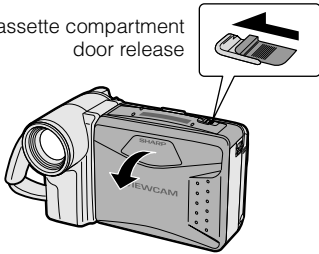

**Note:** The cassette holder will extend and open when the VIEWCAM is connected to a power source. Be sure to close the cassette holder before proceeding to the next step (see page 10).

- 2 Pull out the lithium battery holder using a pointed object such as the tip of a ballpoint pen.

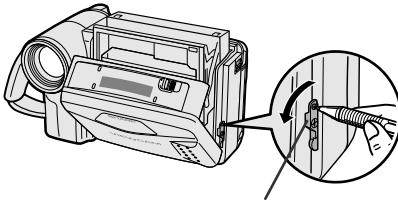

Lithium battery holder

- 3 Insert the lithium battery into the battery holder with the + side of the battery facing the ⊕ side of the holder.

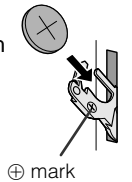

- 4 Push the battery holder back into position.



- 5 Close the cassette compartment door by pressing the center until it clicks into place.

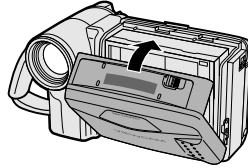

### Removing the Lithium Battery

Perform steps 1 and 2 above, then lift out the battery from the battery holder.

**Note:**

- Replace the battery with a new CR2025 battery when the date and time indicator starts to fall behind the correct time.

### Notes on the Use of the Lithium Battery

REPLACE BATTERY WITH TOSHIBA, MATSUSHITA OR HITACHI MAXELL TYPE CR2025 ONLY. USE OF A DIFFERENT BATTERY MAY PRESENT A RISK OF FIRE OR EXPLOSION.

**WARNING** KEEP THIS BATTERY AWAY FROM CHILDREN. IF SWALLOWED, CONSULT A PHYSICIAN IMMEDIATELY FOR EMERGENCY TREATMENT.

**CAUTION** BATTERY MAY EXPLODE IF MISUSED OR INSTALLED WITH POLARITY REVERSED. DO NOT RECHARGE, DISASSEMBLE OR DISPOSE OF IN FIRE.

- Do not short-circuit, recharge, disassemble, or heat the lithium battery.
- Should the lithium battery leak, wipe the battery compartment and holder clean, and then insert a new battery.
- The lithium battery will last about one year of normal usage.

## Selecting the Language for the On-screen Display

This VIEWCAM allows you to choose from among English, French or Spanish for the on-screen display language.

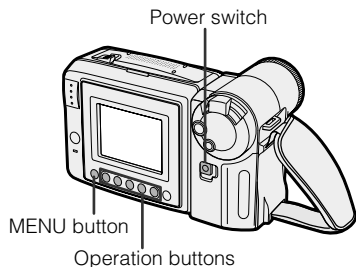

## Setting the Language

When using the VIEWCAM for the first time, select the desired language for the on-screen display by performing the procedure below.

- Hold down the Lock button and slide the Power switch to CAMERA.
  - The language selection screen appears.

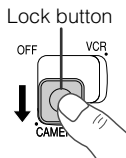

- Press the  $\blacktriangleleft$  or  $\blacktriangleright$  button ( $\blacktriangleleft$  or  $\blacktriangleright$ ) (1) to select the desired language, then press the SET (REGLAGE or AJUSTE) button ( $\blacktriangleright$ ) (2).

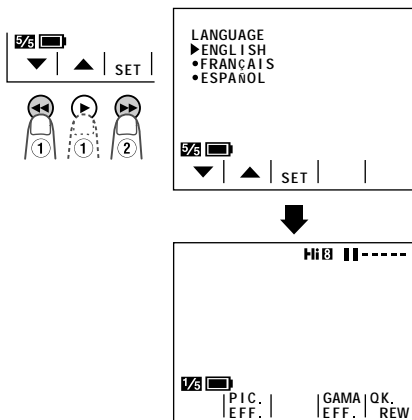

## Changing the Language

- In Recording Standby mode, press the MENU button until 5/6 appears.
- Press the PAGE (PAGE or PAGINA) button ( $\parallel$ ) to display MENU 1.
- Press the  $\blacktriangledown$  or  $\blacktriangle$  button (1) to select "LANGUAGE" ("LANGUE" or "IDIOMA"), then press the SET (REGLAGE or AJUSTE) button ( $\blacktriangleright$ ) (2).
  - The language selection screen appears.

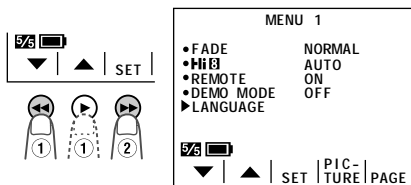

- Press the  $\blacktriangleleft$  or  $\blacktriangleright$  button ( $\blacktriangleleft$  or  $\blacktriangleright$ ) (1) to select the desired language, then press the AJUSTE (SET or REGLAGE) button ( $\blacktriangleright$ ) (2).
  - The menu screen is displayed in the language selected.

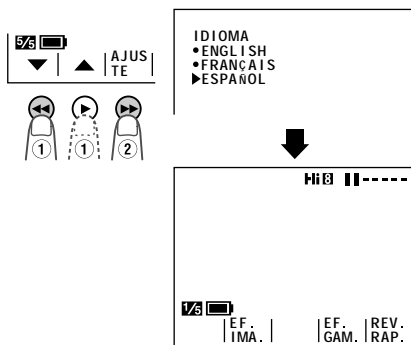

- Press the DISPLAY button to turn off the menu screen.

### Note:

- The operation procedures in the following sections of this operation manual are based on the use of on-screen displays in English.

# Preparation

## English On-screen Displays

The following on-screen displays appear when “ENGLISH” is selected as the on-screen display language (see page 12).

Preparation

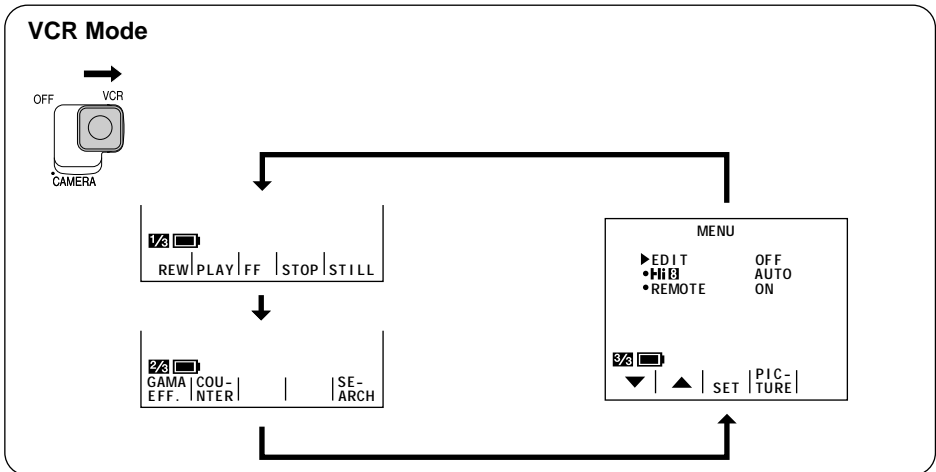
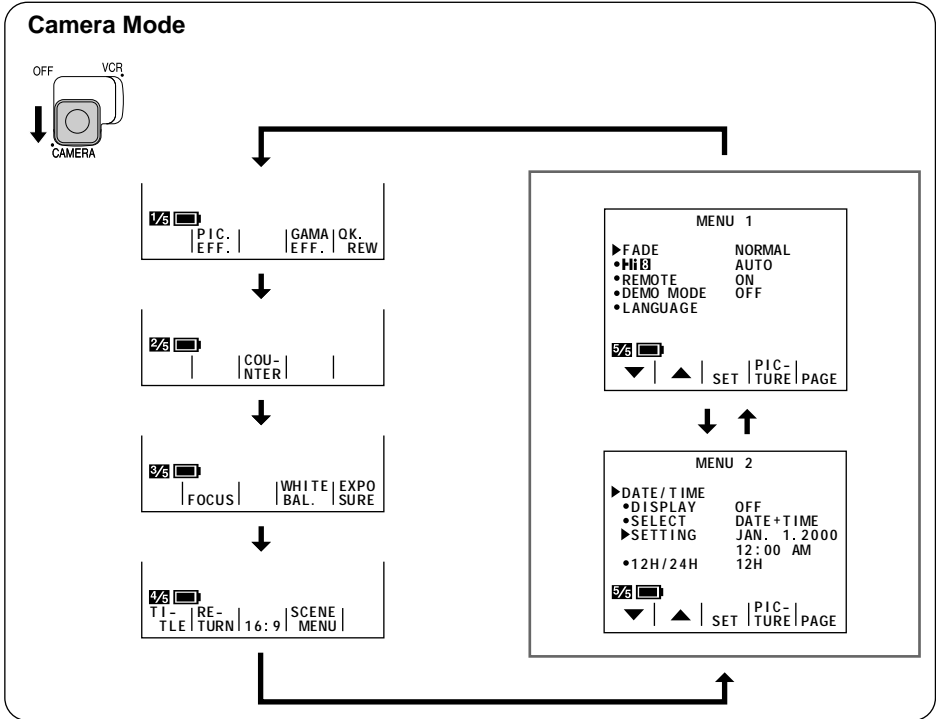

**13 Note:** See pages 24 and 25 for the procedure to display the desired screen.

## French On-screen Displays

The following on-screen displays appear when “FRANÇAIS” is selected as the on-screen display language (see page 12).

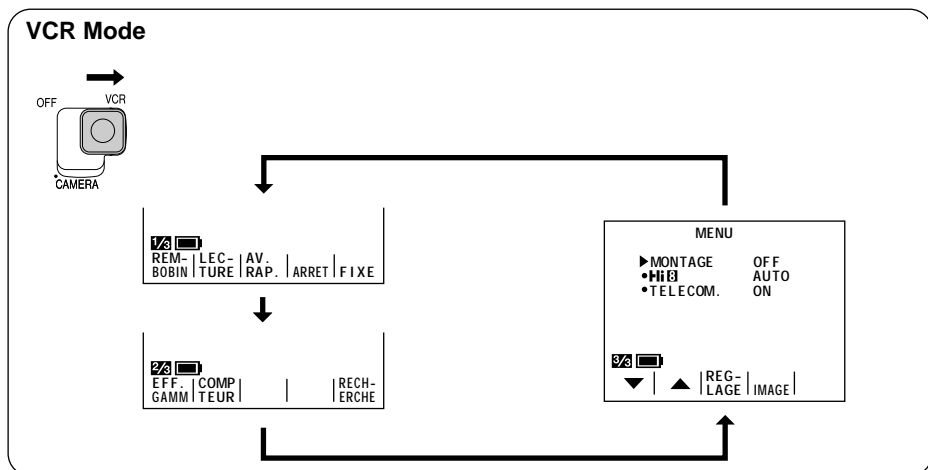
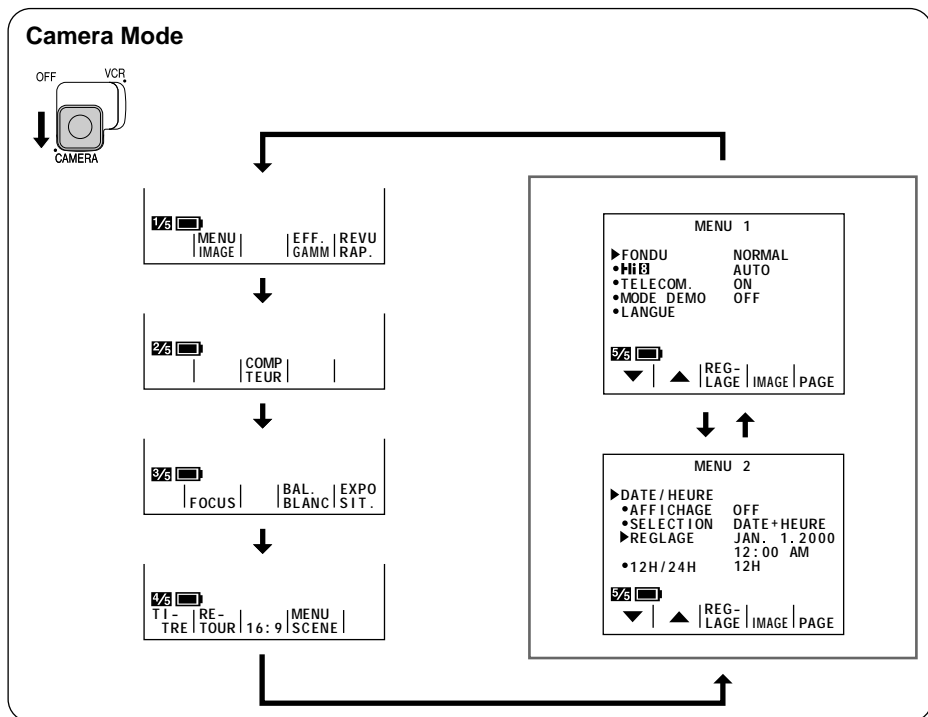

# Preparation

## Spanish On-screen Displays

The following on-screen displays appear when “ESPAÑOL” is selected as the on-screen display language (see page 12).

Preparation

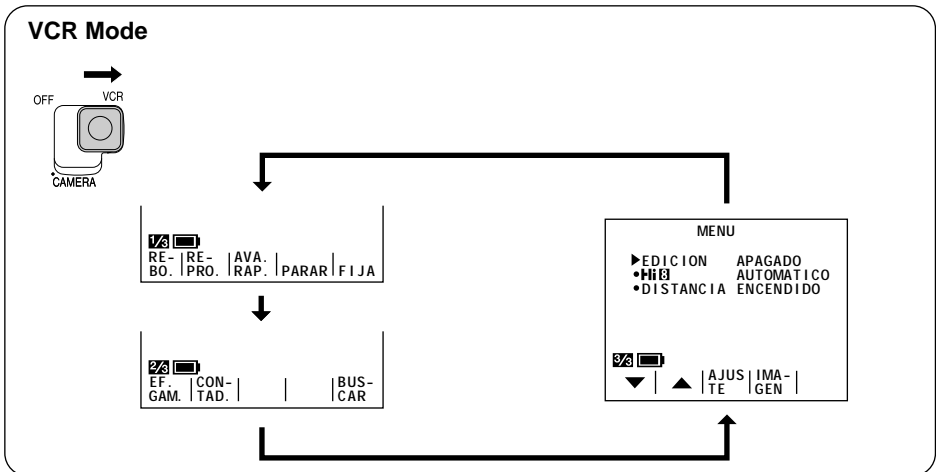
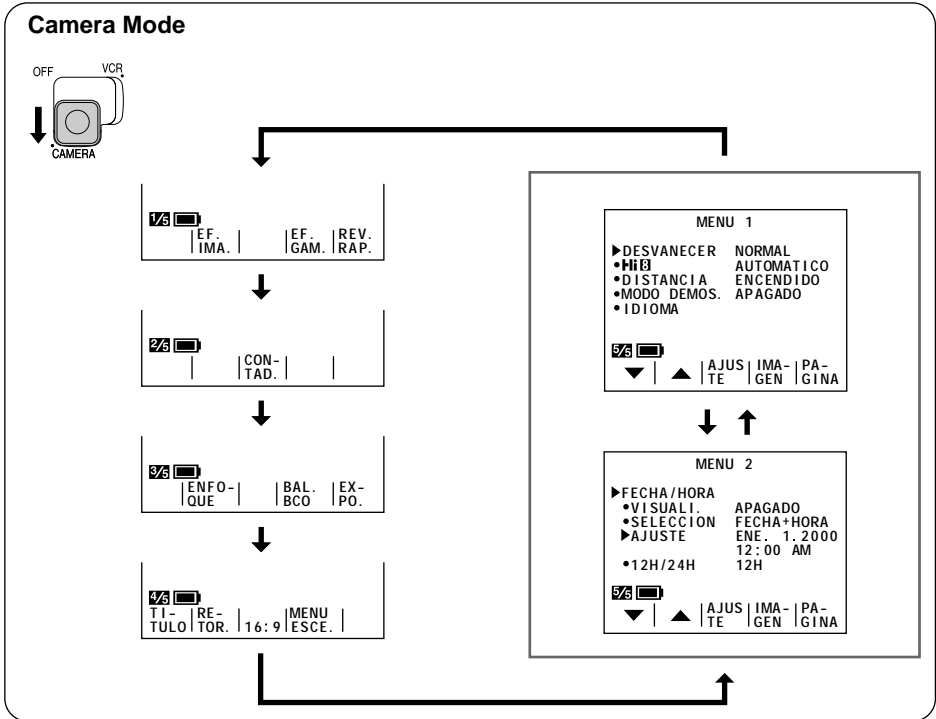



## Setting the Date and Time

**Example:** Setting the date to June 2, 2001 (JUN. 2. 2001) and the time to 10:30 am (10:30 AM).

**Note:**

- Check that the lithium memory battery has been installed before setting the date and time.

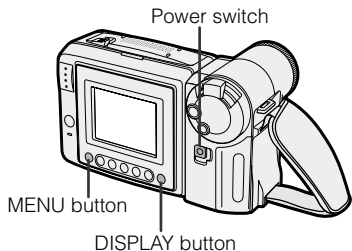

- 1 Hold down the Lock button and slide the Power switch to CAMERA.

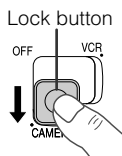

- 2 Press the MENU button until  $\frac{5}{5}$  (MENU 2) appears.

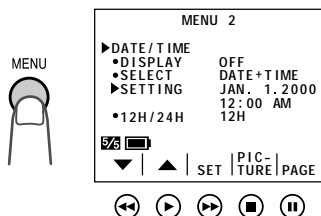

- If MENU 1 appears on the  $\frac{5}{5}$  screen, press the PAGE button (⏪) to display MENU 2.

- 3 Press the SET button (▶▶).

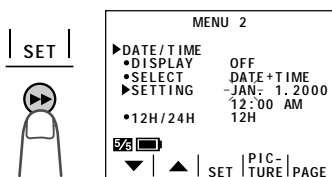

- When changing the date and time settings, press the ▼ or ▲ button (◀ or ▶) to select "SETTING", then press the SET button.

- 4 Press the ▼ or ▲ button (◀ or ▶) to select "JUN" (month), and press the SET button.

▶SETTING JUN. 1. 2000  
12:00 AM

- 5 Press the ▼ or ▲ button to select "2" (day), and press the SET button.

▶SETTING JUN. 2. 2000  
12:00 AM

- 6 Press the ▼ or ▲ button to select "2001" (year), and press the SET button.

▶SETTING JUN. 2. 2001  
12:00 AM

- 7 Press the ▼ or ▲ button to select "10 AM" (hour), and press the SET button.

▶SETTING JUN. 1. 2. 2001  
10:00 AM

- 8 Press the ▼ or ▲ button to select "30" (minute), and press the SET button.
  - The internal clock now starts operating.

▶SETTING JUN. 2. 2001  
10:30 AM

- 9 Press the DISPLAY button to turn off the menu screen.

### Changing to the 24-hour Time Mode

After performing step 8 above, press the ▼ or ▲ button (①) to select "12H/24H", then press the SET button (▶▶) (②) to select "24H".

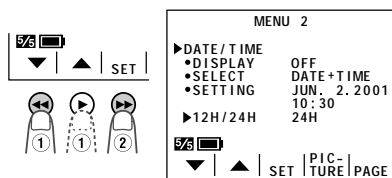

**Notes:**

- The date and time, once set, are stored in memory.
- The menu screen automatically turns off if no settings are made within 5 minutes.

## Preparation

### Using the Hand Strap and the Lens Cap

- 1 Open the hand strap flap (1) and grip strap (2), and pass the grip strap through the loop at the end of the lens cap cord (3).

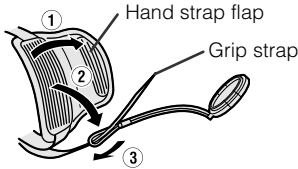

- 2 Pass your hand through the hand strap and put your thumb close to the Power Zoom control. Then pull the grip strap tight until it fits snugly, seal the Velcro® closures (1), and close the hand strap flap (2).

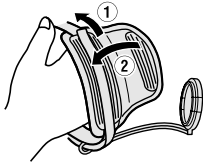

#### Caution:

- Do not swing the VIEWCAM by the hand strap.

### Attaching and Removing the Lens Cap

When attaching or removing the lens cap, press both tabs on the sides of the cap.

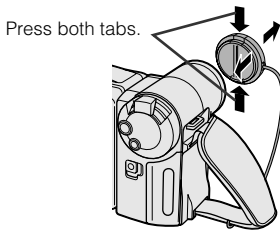

#### Notes:

- Always replace the lens cap on the lens when the VIEWCAM is not in use.
- Attach the lens cap to the hand strap so it will not get in the way during recording.

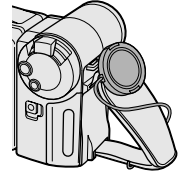

### Attaching the Shoulder Strap

- 1 Hold one end of the strap and thread it through the loop on the left side of the LCD screen.
- 2 Loosen the strap in the buckle, then feed the end of the strap through the buckle, as shown.
- 3 Draw the strap in the direction of the arrow to secure.
- 4-6 Use the same procedure to attach the other end of the strap to the loop on the lens side.

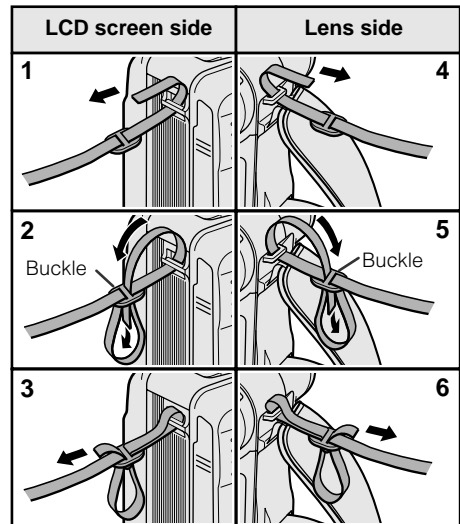

# Basic Operations

## Camera Recording

### Easy Camera Recording with Full Auto Mode

Before you start recording, perform the operations described on pages 7 through 17 to prepare your VIEWCAM for recording.

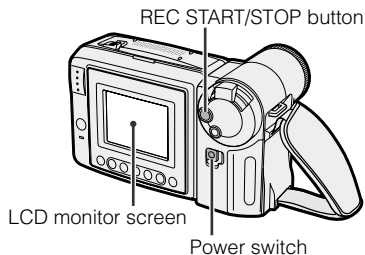

- 1 Remove the lens cap (see page 17).
- 2 Hold down the Lock button and slide the Power switch to CAMERA.
  - The picture from the lens is now displayed on the LCD monitor screen.
  - The VIEWCAM is now ready to record (Recording Standby mode).

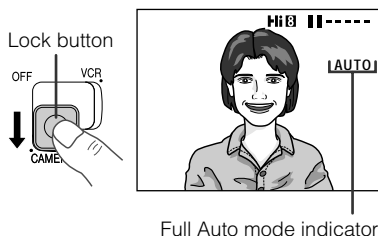

**Note:** If, at this time, "AUTO" does not appear, set the VIEWCAM to Full Auto mode by following the procedure described on page 35.

- 3 Press the REC START/STOP button to begin recording.

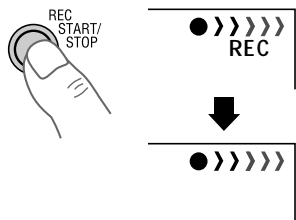

**Note:**

- When recording at the beginning of a tape, advance the tape about 15 seconds before you begin recording. This will prevent the beginning of the recording being cut off when it is played back.

### To Pause Recording

Press the REC START/STOP button again. Recording pauses, and the VIEWCAM enters the Recording Standby mode.

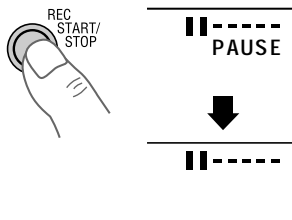

### To Turn the Power Off

Slide the Power switch to OFF.

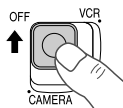

**Notes:**

- The speaker is off in Camera mode.
- Battery power is consumed in Recording Standby mode. Turn off the power if you will not be recording again soon.
- If the VIEWCAM is kept in Recording Standby mode for more than approximately 5 minutes, the power will automatically turn off to save battery power and to protect the tape from being damaged. To continue recording after this, set the Power switch to OFF, and then back to CAMERA.

### Maximum Continuous Recording and Actual Recording Times

Battery pack	Max. continuous recording time	Actual recording time
BT-H22	approx. 1 hr. 35 min.	approx. 45 min.
BT-H32	approx. 3 hr. 10 min.	approx. 1 hr. 30 min.

**Note:**

- Using the zoom (see page 19) and other functions or turning the power on and off frequently will increase power consumption. This may result in a decrease of more than 50% in the actual recording time compared to the maximum continuous recording time listed above.

# Basic Operations

## Camera Recording

### Zooming

Zooming allows you to move visually closer to or farther from a subject without physically changing your position.

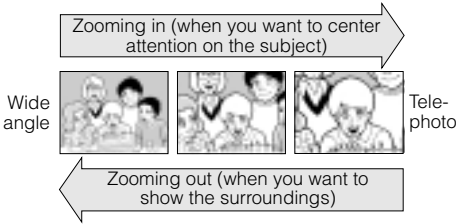

#### To Zoom In

Push the Power Zoom control to the T (telephoto) side to get a close-up view (①).

#### To Zoom Out

Push the Power Zoom control to the W (wide angle) side to get a wide field of view (②).

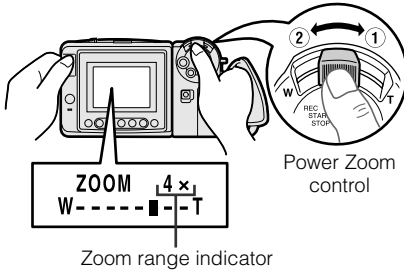

- The on-screen display shows you the current zoom setting.
- The zoom speed changes depending on how far you push the Power Zoom control.

#### Note:

- The VIEWCAM is unable to focus when zooming in on subjects within 5 feet (1.5 m). The VIEWCAM will automatically zoom out until it is able to focus on the subject. (See page 32 for recording macro shots.)

### Tips on Recording Positions

The rotating LCD monitor screen lets you enjoy easy video recording in a more relaxed posture without having to hold the VIEWCAM up to your eye. The LCD monitor also makes it easier to record high-angle and low-angle shots.

#### Holding the VIEWCAM

Put the fingers of your right hand through the hand strap, and place your right thumb close to the REC START/STOP button and Power Zoom control. Place your left thumb on the thumb rest on the left side of the LCD monitor.

#### Basic Posture

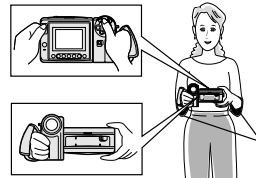

Press your elbows against your sides.

Place your feet at a 45° angle and balance your weight on both legs.



#### High Angle

You can record while still viewing the screen. This is convenient when you want to record over a crowd.

#### Low Angle

Put one knee on the ground for the best stability.



#### Notes:

- In hand-held recording, the VIEWCAM has to be steadied to prevent image shakes. For very stable recording, use a tripod.
- Take care not to touch the microphone with your fingers during recording. It will cause noise on the audio track.

## Remaining Recording Time Display

When the VIEWCAM is recording in Camera mode, about 10 minutes before the tape reaches the end, an on-screen indicator displays the approximate remaining recording time.

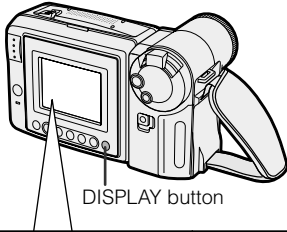

Approx. remaining recording time	On-screen indicator
10 min.–8 min.	<b>TAPE</b> █ █ █ █ █
8 min.–6 min.	<b>TAPE</b> █ █ █ █ █
6 min.–4 min.	<b>TAPE</b> █ █ █ █ █
4 min.–2 min.	<b>TAPE</b> █ █ █ █ █
2 min.–1 min.	<b>TAPE</b> █ █ █ █ █
1 min.–0 min.	THE TAPE ENDS SOON. ↓ -TAPE END-
0 min. (The tape has reached the end.)	CHANGE THE CASSETTE. ↓ TAPE END

To turn off the remaining recording time display, press the DISPLAY button.

### Notes:

- The remaining recording time displays only show the approximate time left. Also, they vary slightly depending on the length of tape used. (This function's design is based on the P6-120 tape standard.)
- If you turn off the remaining recording time display, it will reappear after a short interval to indicate the new time remaining.
- **The remaining recording time display appears 5 seconds after pressing the REC START/STOP button to begin recording.**

## Remaining Battery Power Display

When using the VIEWCAM with the battery pack as the power source, you can turn on and off the remaining battery power display by pressing the DISPLAY button.

If the battery power becomes very low, a warning indicator will appear. Replace the battery pack.

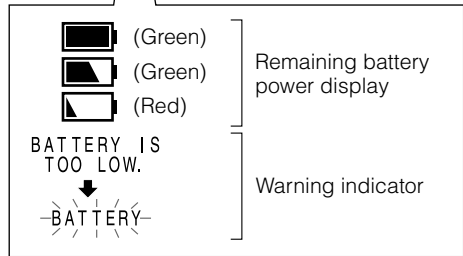
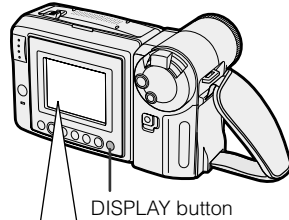

### Notes:

- Use the remaining battery power display only as an approximate indication.
- The battery power display may change to either a higher or lower level if you set the Power switch to OFF and then back to CAMERA or VCR.
- In cold environments, the red remaining battery power display may appear sooner. The battery pack, however, can be used until the warning indicator appears. Replace the battery pack at this time.
- Battery consumption may vary depending on the condition of use.
- Use of the zoom function when the warning indicator is displayed may cause the VIEWCAM to suddenly lose power.

# Basic Operations

## Playback

### Playback

The LCD monitor screen makes it possible to play back and see what you have just recorded. Nothing needs to be connected, allowing instant on-screen playback with the sound through the built-in speaker.

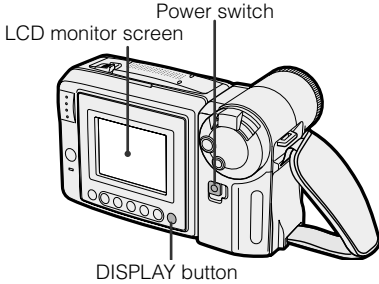

Basic Operations  
Playback

- 1 Hold down the Lock button and slide the Power switch to VCR.
  - The screen appears.

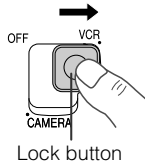

- 2 Press the REW (◀◀) (or FF [▶▶]) button to rewind (or fast forward) the tape to the desired point.



- 3 Press the PLAY button (▶) to begin playback.



### To Stop Playback

Press the STOP button (■).

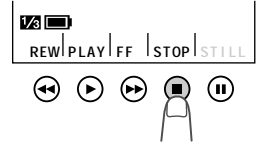

#### Notes:

- If you wish to turn the Operation button indicators on or off, press the DISPLAY button. The playback operation buttons will still function as indicated even after the indicators are turned off.
- To use the infrared remote control, make sure that the REMOTE menu item is set to "ON" (see page 39).

### Auto Tape Rewind

The tape is automatically rewound when playback reaches the end of the tape.

### To Turn the Power Off

Slide the Power switch to OFF.

### Volume Control

While the VIEWCAM is in VCR mode, push the Volume control to the + or - side to increase (①) or decrease (②) the volume to your preference.

The volume level indicator will appear on the screen during adjustment only. When the Volume control is released, the volume level indicator will disappear shortly afterwards.

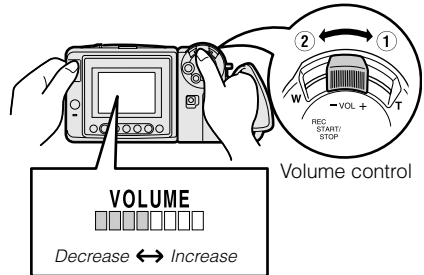

## Watching the Playback on a TV

You can also connect the VIEWCAM to a TV to allow a larger audience to enjoy video playback.

- 1 Lift up the terminal cover on the VIEWCAM (1) and rotate it to the right (2).

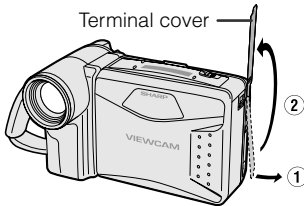

- 2 Connect the VIEWCAM to your TV (or VCR) with the supplied audio/video cable, as shown.

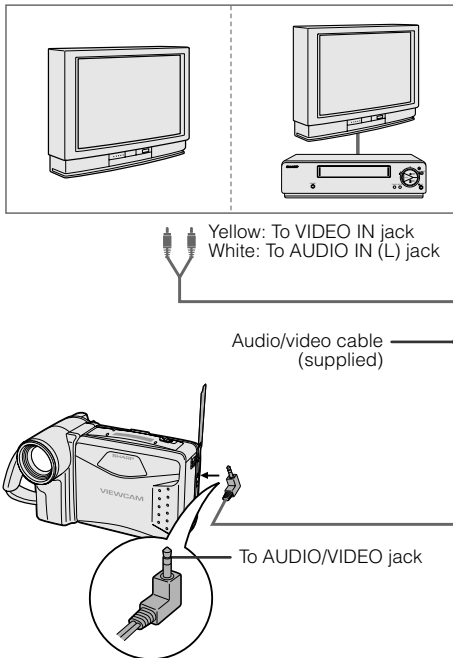

- 3 Turn on the TV and set it to the "AV" or "VIDEO" channel. (See the operation manual of your TV.)
  - When connecting to a TV via a VCR, turn on the VCR and set it to the "AV" or "LINE" input channel. Operate the TV as you normally do to see the signal from the VCR. (See the operation manuals of your TV and VCR.)
- 4 Turn on the VIEWCAM in VCR mode, and begin tape playback (see page 21).

### Caution:

- Make sure that the VIEWCAM, TV, VCR and other equipment to be connected have been turned off before you make connections. Making connections with any of the components left turned on may cause picture noise or a malfunction.

### Notes:

- **This VIEWCAM does not have an S-video socket.**
- When the VIEWCAM is connected to a TV for playback, the picture on the TV screen may flicker if the volume on the VIEWCAM is set to maximum. Should this occur, turn the volume down (see page 21).
- Close the terminal cover after use.

# Basic Operations

## Playback

### Video Search

The video search function makes it easy to search for a desired scene on the tape.

#### Searching for a Scene Near the Current Tape Position

- 1 During playback, press the Forward Search (▶▶) (or Reverse Search [◀◀]) button.
  - The playback picture fast forwards (or reverses).

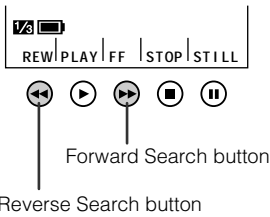

- 2 When you find the desired scene, press the PLAY button (▶) to return to normal playback.

#### Searching for a Scene Far from the Current Tape Position

- 1 During fast forward (or rewind), press and hold down the Forward Search (▶▶) (or Reverse Search [◀◀]) button.
  - The fast forward (or reverse) playback picture is displayed.
- 2 If the desired scene is still rather far from the current tape position, release the button to return to normal fast forward (or rewind).
- 3 Repeat steps 1 and 2 above until you find the desired scene.
- 4 Press the STOP button (■) and then the PLAY button (▶) to begin normal playback.

#### Notes:

- The sound is off during search.
- Some picture noise appears during search. This is not a malfunction.

### Still

The still function makes it possible to pause playback.

During playback, press the STILL button (||).



To return to normal playback, press the STILL button again or press the PLAY button (▶).

### Slow

The slow function makes it possible to play back images in slow motion.

During playback, press the SLOW button (▶) on the remote control.

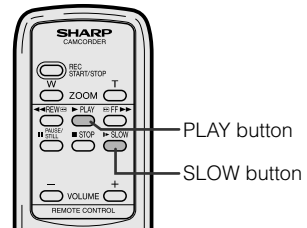

To return to normal playback, press the PLAY button (▶) on the remote control.

#### Notes:

- The sound is off during Still and Slow modes.
- To protect the tape, the VIEWCAM automatically returns to normal playback if it is left in Still mode for more than 5 minutes or in Slow mode for more than 40 seconds.
- If the still or slow functions are used when connected to a TV, noise will appear and distort the playback image.
- In Slow mode, the tape will not automatically rewind when playback reaches the end of the tape.
- **The slow function can only be operated from the remote control.**



# Useful Features

## Operations of the On-screen Controls

### Using the Control Buttons

The following buttons on the VIEWCAM can be used to control the various functions, settings and on-screen displays.

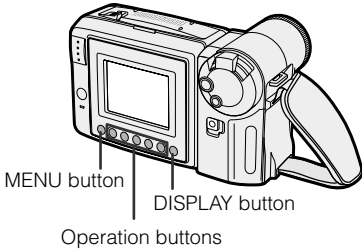

### MENU button

Each time you press the MENU button, the mode/menu screen changes from  $\frac{1}{3}$  to  $\frac{5}{3}$  in Camera mode and from  $\frac{1}{3}$  to  $\frac{3}{3}$  in VCR mode.



### DISPLAY button

Press the DISPLAY button to turn the mode/menu screens and on-screen indicators on or off.



### Note:

- The warning indicators and some other indicators cannot be turned off by pressing the DISPLAY button.

### Operation buttons

Press the Operation button corresponding to the indicator of the desired function displayed on the screen.



### Note:

- The Operation button indicators are normally displayed in blue or gray. When a function is selected, its indicator is displayed in yellow.

## Selecting the Mode/Menu Screens

You can use the mode screens to select various functions and the menu screens to adjust various settings. Follow the procedure below to display the mode/menu screen with the indicator of the desired function/setting.

- Hold down the Lock button and slide the Power switch to CAMERA (Camera mode) or VCR (VCR mode).

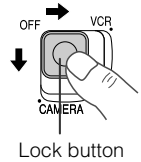

- Press the MENU button until the desired screen appears.

### Camera mode

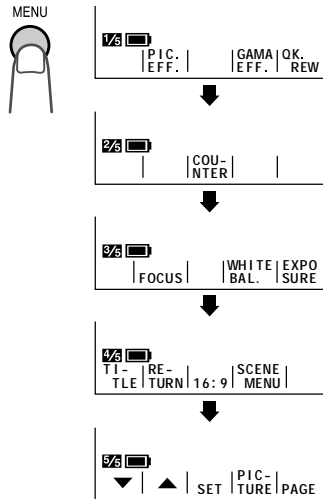

### VCR mode

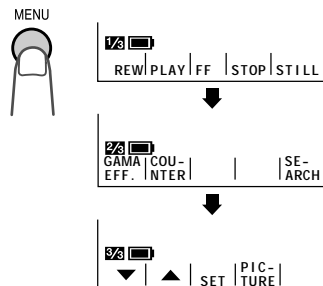

# Useful Features

## Adjusting the Menu Settings

Follow the procedure below to adjust the desired menu settings.

### Camera mode

- 1 Hold down the Lock button and slide the Power switch to CAMERA.
- 2 Press the MENU button until 5/6 appears.

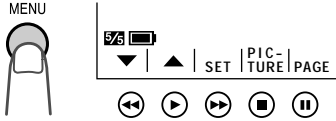

- 3 Press the PAGE button (||) to display the desired menu screen.
  - Each time you press the PAGE button, the screen changes between MENU 1 and MENU 2.

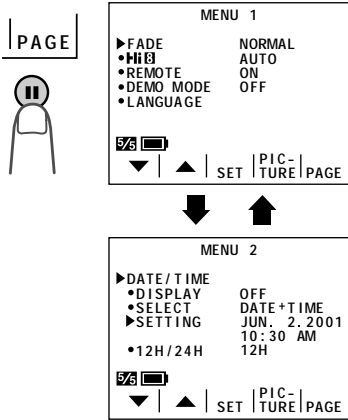

- 4 Press the ▼ or ▲ button (◀◀ or ▶▶) to select the desired menu item.

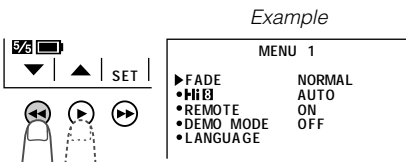

- 5 Press the SET button (▶▶) to select the desired setting.
  - Each time you press the SET button, the setting changes.

Example

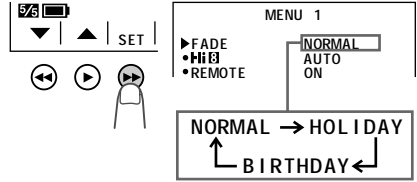

- 6 Press the DISPLAY button to turn off the menu screen.

### VCR mode

- 1 Hold down the Lock button and slide the Power switch to VCR.
- 2 Press the MENU button until 5/6 appears.

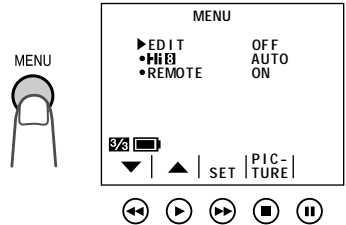

- 3 Perform steps 4 to 6 above.

### Notes:

- Certain menu items are common in both Camera and VCR modes. If the REMOTE menu item, for example, is set to "OFF" in Camera mode, it will be automatically set to "OFF" in VCR mode.
- The menu screen automatically turns off if no settings are made within 5 minutes.

# Recording the Date and Time

Follow the procedure shown below to record the date and time, or the date only, along with the subject.

**Note:**

- Before performing the procedure below, make sure that the date and time have been correctly set (see page 16).

**1** In Recording Standby mode, press the MENU button until (MENU 1) appears.

**2** Press the PAGE button () to display MENU 2.

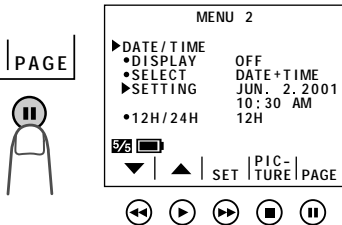

**3** Press the or button to select "DISPLAY".

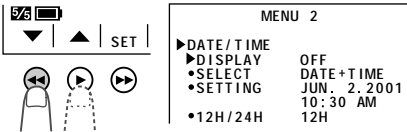

**4** Press the SET button () to select "AUTO", "ON", or "OFF".

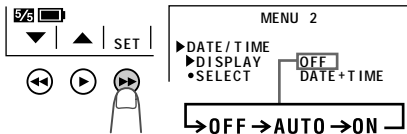

When "AUTO" is selected, the date/time is displayed and recorded for 10 seconds at the beginning of the first recording of each day.

When "ON" is selected, the date/time is continuously displayed and recorded.

When "OFF" is selected, the date/time is neither displayed nor recorded.

**Note:** In "AUTO", if you wish to record the date/time a second time that day, repeat the procedure above and re-select "AUTO".

**5** Press the button to select "SELECT".

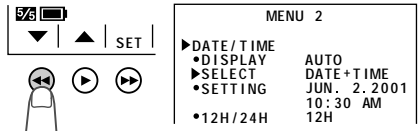

**6** Press the SET button () to select "DATE+TIME" or "DATE".

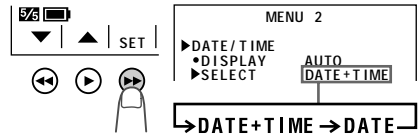

When "DATE+TIME" is selected, both the date and the time are displayed and recorded.

When "DATE" is selected, only the date is displayed and recorded.

**7** Press the DISPLAY button to turn off the menu screen, and then press the REC START/STOP button to begin recording.

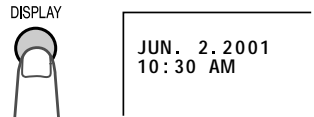

## Fade In and Fade Out

The fade function allows you to gradually bring the image and sound in or out at the beginning or end of a scene to create a scene transition. This VIEWCAM features one normal and two animated fade modes.

### Type of Fade Modes

**NORMAL:** The picture fades in from and out to white.

**HOLIDAY:** The picture fades in from an animated firework sequence with the title "HAPPY HOLIDAYS!", and fades out to white.

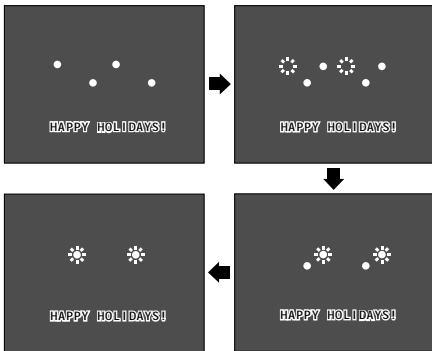

**BIRTHDAY:** The picture fades in from an animated birthday cake sequence with the title "HAPPY BIRTHDAY!", and fades out to white.

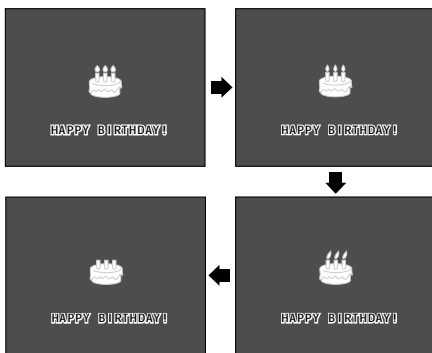

## Selecting Fade Mode

- 1 In Recording Standby mode, press the MENU button until (MENU 1) appears.

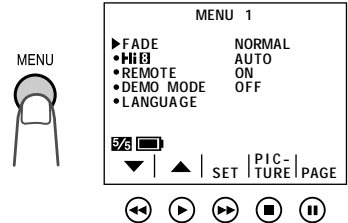

- 2 Press the or button (1) to select "FADE", then press the SET button () (2) to select the desired fade mode.

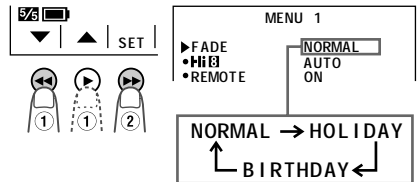

- 3 Press the DISPLAY button to turn off the menu screen.

## Using Fade Mode

- 1 In Recording Standby mode, press the FADE button.
  - The selected fade mode indicator appears. ("FADE" is displayed for the NORMAL fade mode indicator.)

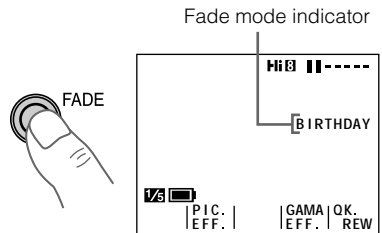

## 2 Press the REC START/STOP button to begin recording.

- The picture and sound fade in with the selected fade mode.



## 3 Press the REC START/STOP button at the point where you wish to stop recording.

- The picture and sound fade out as the screen gradually turns white. The VIEWCAM then returns to Recording Standby mode.

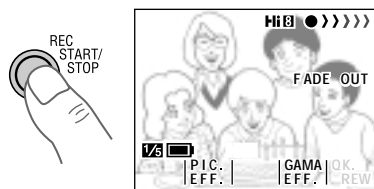

### To cancel Fade mode

Press the FADE button.

### To use fade out only

- 1 During recording, press the FADE button.
- 2 Press the REC START/STOP button at the point where you wish to stop recording.

## Quick Review

The quick review function lets you check the last 5 seconds of tape just recorded without switching to VCR mode, to make sure that the recording has come out right.

- 1 In Recording Standby mode, press the MENU button until  $\frac{1}{3}$  appears.



- 2 Press the QK. REW button (II).
  - The tape rewinds to the point of 5 seconds before the current tape position; playback then starts automatically.

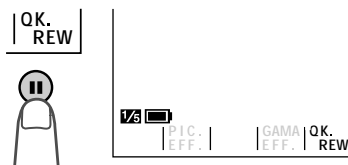

After 5 seconds of playback, the VIEWCAM enters the Recording Standby mode.

## Quick Return

When you have been playing back what you have recorded, and wish to quickly return to recording again from the end of the last recorded scene, use the quick return function.

- 1 In Recording Standby mode, press the MENU button until  $\frac{4}{5}$  appears.



- 2 Press the RETURN button (▶).
  - "QUICK RETURN" flashes, and the tape will begin fast forwarding or rewinding to the end of the last recorded scene.

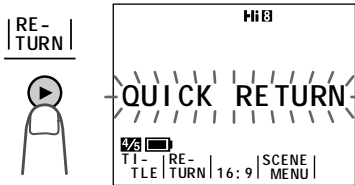

When the tape reaches the end of the last recorded scene, the VIEWCAM enters the Recording Standby mode.

**Notes:**

- To cancel the quick return function, press the RETURN button again in step 2.
- If the cassette has been removed since the last recording, if no recording has been made since the last recording, or if the power source has been interrupted, the RETURN button indicator will not appear and the quick return function cannot be used.

## Edit Search

The edit search function lets you search, without switching from Camera mode to VCR mode, for the point on the tape where you wish to start recording next.

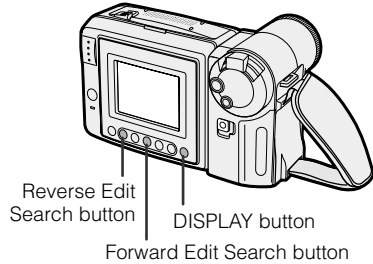

- 1 In Recording Standby mode, make sure that no Operation button indicators are displayed on the monitor.
  - If they are displayed, turn them off by pressing the DISPLAY button.
- 2 Press and hold down the Forward Edit Search button (▶▶) or Reverse Edit Search button (◀◀).

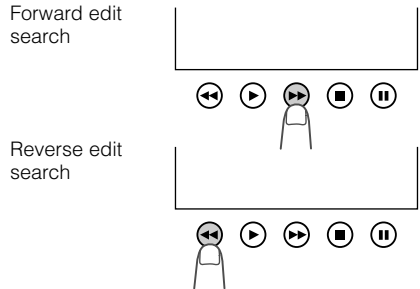

- 3 When you find the point where you want to begin recording, release the button.

**Notes:**

- The sound is off during search.
- Some picture noise appears during reverse edit search.
- Forward edit search is performed at the same speed as normal playback, and reverse edit search at three times the normal playback speed.

# Gamma Brightness Compensation

When the subject is backlit, the image will be darkened if it is recorded normally. The gamma brightness compensation function improves the picture by increasing the brightness of the subject while leaving the brighter portions of the image unaffected.

- 1 Press the MENU button until  $\frac{1}{3}$  appears (Camera mode).
- 2 Press the GAMA EFF. button (■) once.
  - "GAMMA" appears, indicating that the Gamma Brightness Compensation is now working.

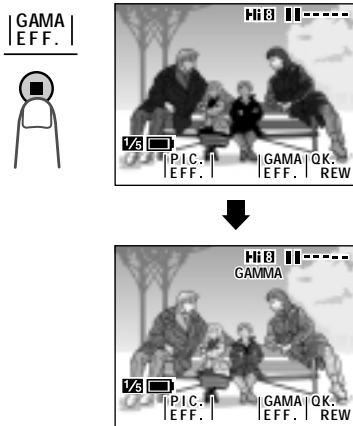

- Note:**
- The gamma brightness compensation function can also be used during playback. See page 48, "Gamma Playback".

## To obtain a brighter picture

Press the GAMA EFF. button (■) again.

- The  $\frac{1}{3}$  indicator appears.

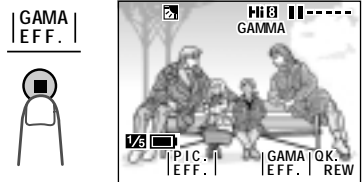

**Note:**

- When the  $\frac{1}{3}$  indicator is displayed, the background will become slightly brighter.

## To cancel Gamma Brightness Compensation

Press the GAMA EFF. button until "GAMMA" disappears.

## Gain-up (Cat's Eye)

When you are recording in a dark or poorly illuminated location, "LIGHT" is displayed on the screen. Use the gain-up function to record a brighter picture.

- 1 Press the MENU button until  $\frac{1}{3}$  appears (Camera mode).
- 2 Press the GAMA EFF. button (■) once.
  - "GAMMA" appears, indicating that the gain-up function is now working.

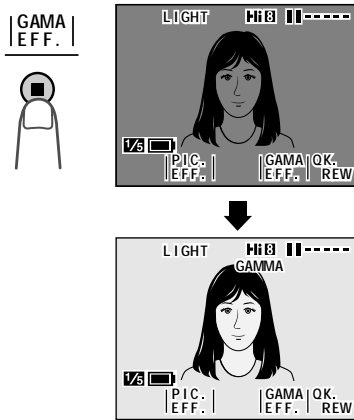

## To cancel the gain-up function

Press the GAMA EFF. button until "GAMMA" disappears.

### Notes:

- The Gain-up mode will disengage and the  $\nabla \times \nabla$  indicator will disappear automatically if the VIEWCAM is moved to a bright location.
- Some picture noise appears in Gain-up mode. The picture noise increases when the  $\nabla \times \nabla$  indicator is displayed.

## To obtain a brighter picture

Press the GAMA EFF. button (■) again.

- The  $\nabla \times \nabla$  indicator appears.

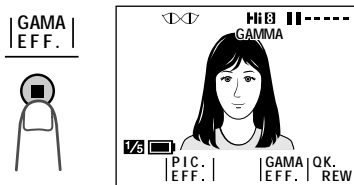



## Wide Screen (16:9)

The wide screen function lets you record scenes with the wide-screen feel of a movie shown in a theater. The top and bottom of the picture are masked with black bands to produce an effective screen aspect ratio of 16:9.

- 1 Press the MENU button until  $\frac{4}{3}$  appears (Camera mode).



- 2 Press the 16:9 button (▶▶).
  - The monitor now displays the picture with the top and bottom portions masked.



- 3 Press the DISPLAY button to turn off the Operation button indicators.

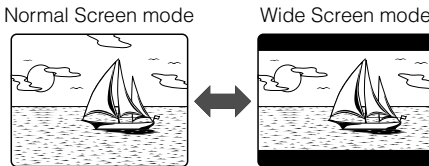

### To return to normal picture

Perform step 1 above, and press the 16:9 button.

#### Note:

- You can only use the wide screen function when the VIEWCAM is in Camera mode.

## Macro Shots

This VIEWCAM lets you shoot close-up images of small objects such as flowers and insects, or make title frames for your videos. When you want to record a magnified image of a subject which is within approximately 5 feet (1.5 m) of the VIEWCAM, do not zoom in on it. Instead, zoom out all the way by pushing the Power Zoom control to the W side, and then move the VIEWCAM closer to the subject until you obtain the desired angle of view. The VIEWCAM will automatically focus on the subject when the lens is set for the widest angle.

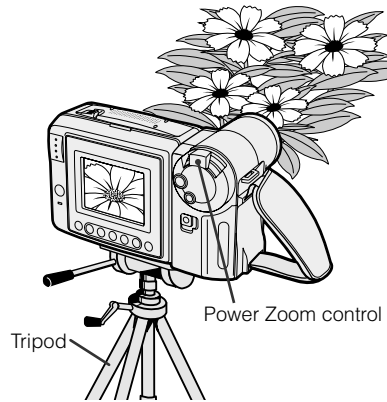

#### Notes:

- When you are recording a macro shot, be sure that the subject receives sufficient illumination.
- It is recommended that you use a tripod for recording macro shots, to prevent image shakes.

## Removing the Lens Hood

The lens hood can be removed (e.g. for cleaning the lens) by rotating it in a counterclockwise direction (①) and then gently pulling it off (②).

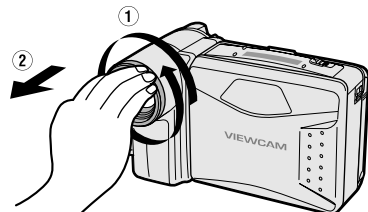

### Self Recording

The LCD monitor can be rotated 180° vertically so that the monitor screen faces the subject. This lets you record yourself while watching your image on the screen.

You can enjoy recording a portrait of yourself, or recording yourself and your friends together at a party, using the remote control.

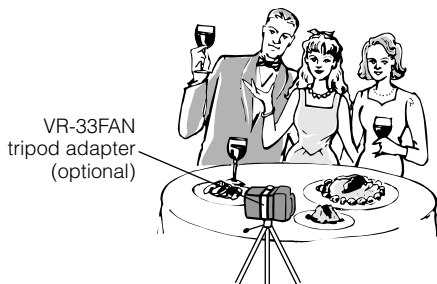

### Normal Self Recording

- 1 Set the Power switch to CAMERA.
- 2 Rotate the monitor section 180° vertically.
  - The screen image will be inverted to show a mirror image of the subject, and the self-recording mode screen appears.

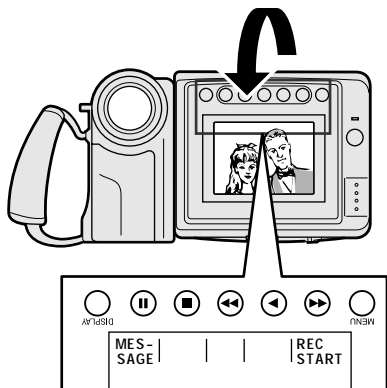

- 3 Press the Power Zoom control to obtain the desired angle of view.

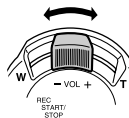

- 4 Press the REC START button (▶▶) to begin recording.

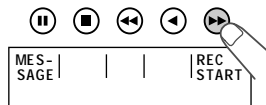

To pause recording, press the REC STOP button (▶▶).

#### Cautions:

- Do not rotate the monitor to the self recording position during recording or playback.
- For recording in Self Recording mode, be sure to rotate the monitor, NOT the lens. If you hold the VIEWCAM upside down with the lens at the bottom, the subject will be recorded upside down.

#### Notes:

- You will need the VR-33FAN tripod adapter for 180° recording (optional accessory) if you want to use a tripod when recording in Self Recording mode.
- In Self Recording mode, only the REC START/STOP button and the Power Zoom control buttons can be used on the remote control.

### More Information on Self Recording

- The screen image is automatically inverted when the monitor rotation is between 135° and 200°. When the monitor is turned back to the normal position, the image returns to normal.
- In Self Recording mode, all standard warning indicators on the screen are replaced by the flashing ⬠ indicator. To check the type of warning, rotate the monitor back to the normal position.
- In Self Recording mode, it is not possible to record using manual recording modes, change picture adjustments, display menus, record the date and time, or use the Quick Return and some of the other functions.
- You can play back images even while the monitor is in the self recording position. Set the Power switch to VCR. The Operation buttons still retain their functions as during normal playback, even though the button indicators are not displayed. (For example, the ◀ button still works as the Play button.)

## Self-recording Message

In Self Recording mode, you can record a short video message for somebody. This feature is convenient for editing video letters.

- Complete steps 1 to 3 of "Normal Self Recording" on page 33, then perform the procedure below.

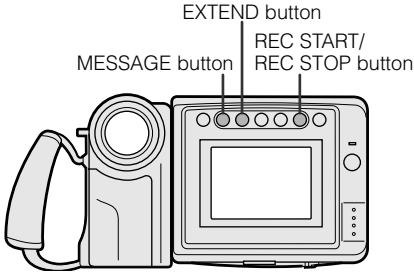

- 1 Press the MESSAGE button (||) to display the self-recording message screen.

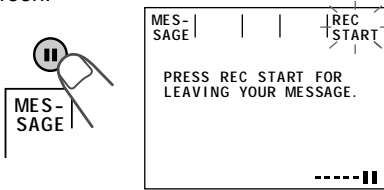

- To cancel, press the MESSAGE button again.

- 2 Press the REC START button (▶▶) to begin recording. Record your message while facing the lens of the VIEWCAM.

- The recording time is preset for 20 seconds.
- The bar on the screen indicates the remaining recording time.

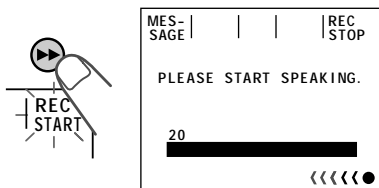

- 3 When the remaining recording time reaches 5 seconds, "EXTEND" will begin flashing.

- When you want to extend the recording time, press the EXTEND button (■) within 5 seconds. You may record continuously for 10 more seconds.

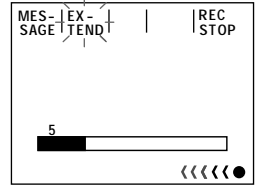

At the end of the recording, the screen fades out, and the VIEWCAM returns to Recording Standby mode.

### Note:

- When you want to stop recording before message recording stops automatically, press the REC STOP button (▶▶).

## Setting the VIEWCAM to Full Auto Mode

This VIEWCAM is equipped with auto focus, auto white balance, and auto exposure functions. For easy, high-quality camera-recording, record subjects in Full Auto mode.

If "AUTO" is not displayed even when the DISPLAY button is pressed, perform the procedure below to set the VIEWCAM to Full Auto mode.

- 1 In Recording Standby mode, press the MENU button until  $\frac{1}{2}$  appears. If "PIC. EFF." is not displayed above the ► button, press this button until "PIC. EFF." appears.

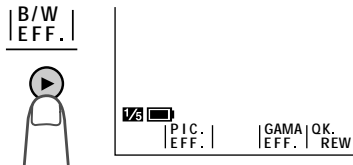

- 2 Press the MENU button until  $\frac{2}{3}$  appears. If "MAN'L FOCUS" is displayed, press the ► button to change it to "FOCUS".

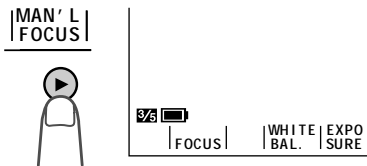

- 3 If "WHITE BAL." is displayed in yellow, press the WHITE BAL. button (■).
  - "WHITE BAL." returns to blue.

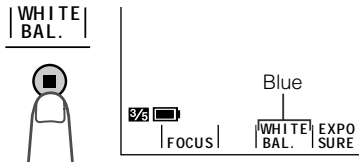

- 4 If "EXPOSURE" is displayed in yellow, press the EXPOSURE button (||) to display the exposure setting screen, then press the AUTO button (▶▶).
  - The exposure setting screen turns off and "EXPOSURE" returns to blue.

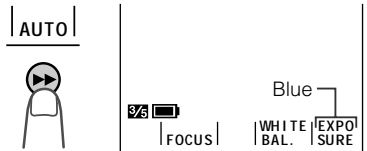
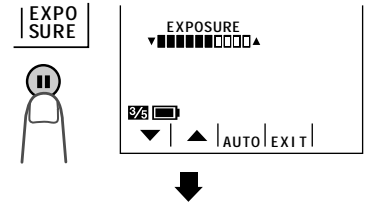

- 5 Press the MENU button until  $\frac{4}{5}$  appears. If "SCENE MENU" is not displayed above the ■ button, press this button until "SCENE MENU" appears.

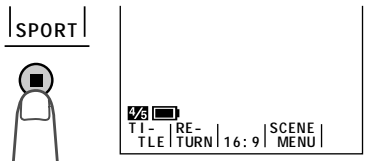

- 6 Press the DISPLAY button.
  - The Operation button indicators disappear, and "AUTO" is displayed on the screen.

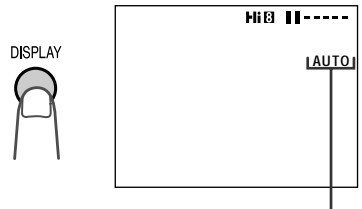

Full Auto mode indicator

## Program Search

The program search function automatically finds and plays back the beginning of a number of previously recorded scenes. Up to 10 different scenes can be found on one tape.

**Note:**

- This function does not work if no recording has been made since the cassette was loaded, if the cassette has been removed after the recordings were made, or if the power source has been interrupted.

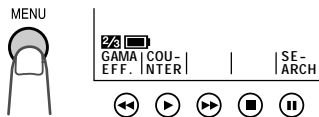

- 1 Press the MENU button until  appears (VCR mode).

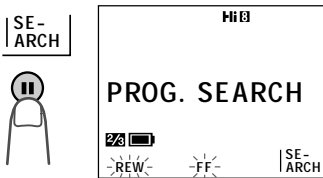

- 2 Press the SEARCH button ().
  - "PROG. SEARCH" is displayed and one of or both "REW" and "FF" will start flashing.



- To cancel, press the SEARCH button again.

- 3 Press the REW () (or FF []) button.

- The tape rewinds (or fast forwards) to the beginning of a scene immediately before (or after) the current tape position; playback then starts automatically.

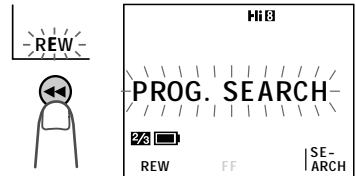



- 4 To continue searching, press the REW (or FF) button while "REW" (or "FF") is still displayed.

**Notes:**

- Use this function when the tape is stopped or being played back.
- This function finds the beginning of each scene immediately before or after the current tape position. It is not possible to skip a scene.
- This function cannot spot recordings that are shorter than 10 seconds in length.
- In steps 2 and 4, if the tape is at a point ahead of the last (or before the first) recording, the FF (or REW) indicator will not appear.

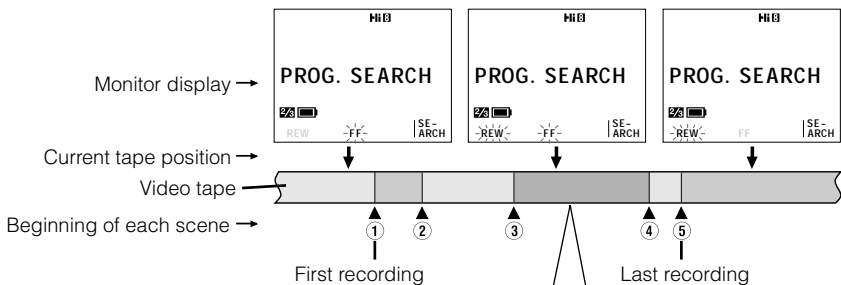
**Example:** When using a tape with five different scenes.



When you are at this position:  
 Press the REW button () to rewind the tape to ③ and begin playback.  
 Press the FF button () to forward the tape to ④ and begin playback.

## Tape Counter Feature

The tape counter shows elapsed playback or recording time in hours, minutes and seconds. (The counter continues to count internally even while it is not being displayed.) This feature can be set and used in both VCR and Camera modes.

### Using the Counter

#### VCR mode

- 1 Press the MENU button until  $\frac{2}{3}$  appears.

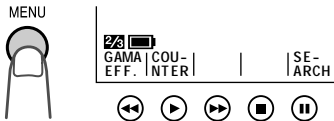

- 2 Press the COUNTER button (▶) to display the tape counter.

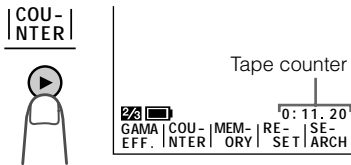

- 3 Press the MENU button until  $\frac{1}{3}$  appears, then begin playback.
  - You can check the playback time with the tape counter.

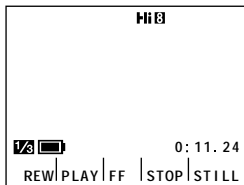

#### Camera mode

- 1 Press the MENU button until  $\frac{2}{3}$  appears.
- 2 Press the COUNTER button (▶▶) to display the tape counter.
- 3 Press the REC START/STOP button to begin recording.
  - You can check the recording time with the tape counter.

#### Notes:

- The counter reading may differ slightly from the actual time. This is especially noticeable when the tape has been rewound or fast forwarded a number of times, in which case there can be a difference of several seconds.
- The tape counter feature will be canceled if the power source is interrupted.

#### To turn off the tape counter

Perform step 1 above, and press the COUNTER button.

#### To reset the counter to zero

During playback (or recording), perform steps 1 and 2 above, then press the RESET button at the point where you wish to reset the counter to zero. The counter will indicate 0:00.00.

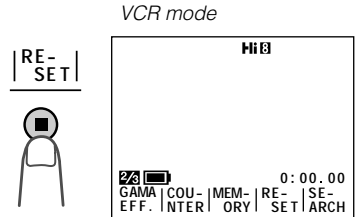

## Using the Counter Memory

Use the counter memory feature when you want to return to the beginning of a particular scene. The position where the counter was reset (0:00.00) is stored in memory to make it easier to return to that point on the tape.

### VCR mode

- 1 During playback, press the MENU button until  appears.



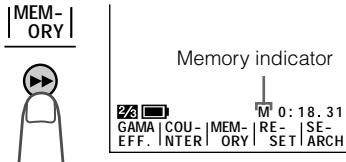

- If "MEMORY" is not displayed, press the COUNTER button.

- 2 Press the MEMORY button to set the counter to Counter Memory mode.
  - "M" will be displayed to the left of the counter.

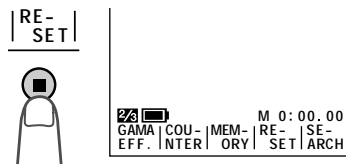

- 3 Press the RESET button to reset the counter to zero at the beginning of the scene that you want to return to later.



- 4 Press the MENU button until  appears. When you are ready to finish playback, press the STOP button (■).

- 5 Press the REW button (◀◀).
  - The tape will automatically stop when the counter reaches 0:00.00.

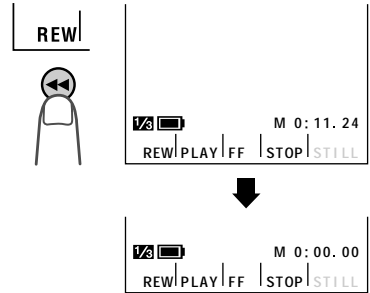

### Notes:

- The FF button (▶▶) can be used in the same way.
  - The tape may stop slightly ahead or behind the point where you reset the counter to "M 0:00.00".
- 6 Press the PLAY button (▶) to view the desired scene.

### Camera mode

- 1 During recording, press the MENU button until  appears.
  - If "MEMORY" is not displayed, press the COUNTER button.
- 2 Perform steps 2 and 3 above.
- 3 When you are ready to finish recording, press the REC START/STOP button.
- 4 Set the Power switch to VCR, then perform steps 5 and 6 above.

### To cancel Counter Memory mode

Perform step 1 above, and press the MEMORY button. "M" will disappear from the screen.

### Note:

- This feature does not work during video search.

## Useful Features

### Using the Remote Control

Use the remote control to operate the VIEWCAM from a distance, such as when you want to record yourself in a scene, or when the VIEWCAM is connected to a TV for use as a VCR.

#### Installing the Batteries in the Remote Control

- 1 Open the battery compartment cover.
- 2 Insert the two supplied AA (R6 or UM/SUM-3) batteries with the battery poles positioned as indicated.

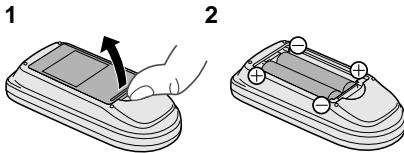

- 3 Replace the cover.

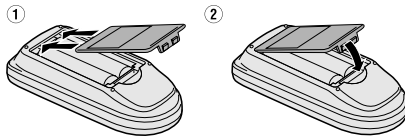

#### Caution:

- Do not use old and new batteries together or batteries of different brands together.

#### Turning On the Remote Control Mode

- 1 Press the MENU button until appears (VCR mode).
- 2 Press the or (1) to select "REMOTE", then press the SET button () (2) to select "ON".

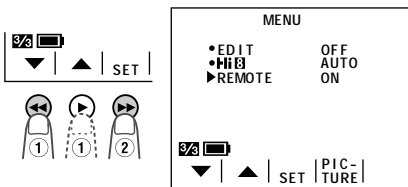

- 3 Press the DISPLAY button to turn off the menu screen.

### Operating the Remote Control

Aim the remote control at the remote sensor of the VIEWCAM, and press the control buttons for operation.

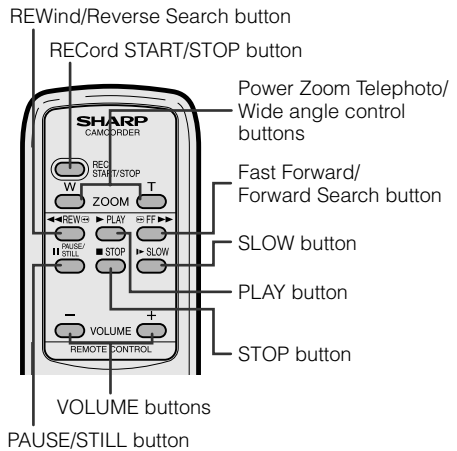
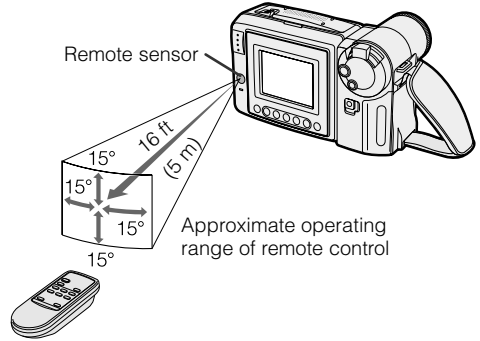

#### Notes:

- Be careful not to allow direct sunlight or bright light from interior illumination to fall onto the VIEWCAM remote sensor, as this may prevent the remote control from operating properly.
- Be sure that there are no obstacles between the remote control and the VIEWCAM remote sensor.
- The remote control cannot be used to move the pointer, or select or set any of the various functions on the monitor.
- When the batteries are depleted and the remote control does not operate, replace them with new AA (R6 or UM/SUM-3) batteries.
- You can also turn on the Remote Control mode on the (MENU 1) screen in Camera mode.



# Advanced Features

## Digital Picture Effects

These digital picture effects let you record the subject with a more dramatic effect.

### Type of Digital Picture Effects

**B/W EFF.:** The picture is recorded in black-and-white.

**SEPA EFF.:** The picture is recorded in sepia color similar to that of an old photograph.

**SOLARI:** The contrast of the subject is enhanced, creating a unique artistic image.

**NEGA EFF.:** The blacks and whites of the image are reversed and colors of the image are inverted.

### To cancel the digital picture effect

Select "PIC. EFF." in step 2 above.

**Note:**

- The digital picture effect will be canceled if the power source is interrupted.

- 1 In Recording Standby mode, press the MENU button until **1/3** appears.

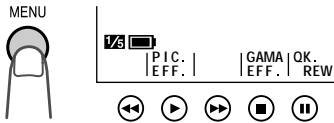

- 2 Press the **▶** button to select the desired digital picture effect.

- Each time you press the **▶** button, the digital picture effect changes as shown below.

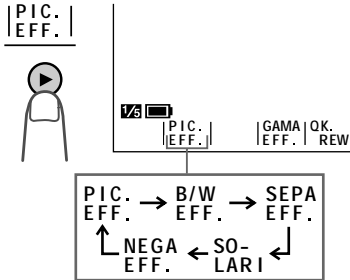

- 3 Press the DISPLAY button to turn off the Operation button indicators.

## Scene Menu (Program AE)

You can set the VIEWCAM to the shooting mode that will create the best results for a specific type of shooting situation. Just select one of the four scene settings shown below. The VIEWCAM will automatically set the exposure, white balance, and shutter speed to produce the optimum picture quality for the selected situation.

### Type of Scene Settings

**SPORT:** When you want to record a fast-moving subject.

**SUNLIGHT:** When the background is very bright.

**DUSK:** When you want to faithfully record the red of the setting sun, and the surrounding twilight.

**PARTY:** When the illumination is from a spotlight or candles.

### To cancel the scene setting

Select "SCENE MENU" in step 2 above.

#### Notes:

- Even after you turn off the scene setting indicator, the selected scene setting will remain in effect.
- When "SPORT" is selected, recording under the light of fluorescent lamps, mercury lamps, or sodium lamps may cause color shifts or fluctuations in picture brightness.
- When "DUSK" is selected, the picture may not be satisfactory if the lighting is very dim.
- It is recommended that you select "SCENE MENU" to record outdoor parties.
- The scene setting will be canceled if the power source is interrupted.

- 1 In Recording Standby mode, press the MENU button until appears.



- 2 Press the button to select the scene setting that best fits the recording situation.

- Each time you press the button, the scene setting changes as shown below.

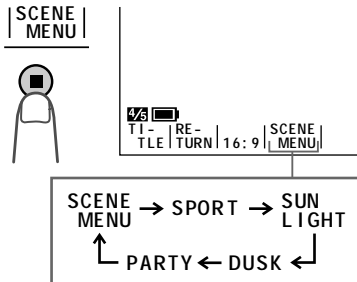

# Superimposing a Title

Use the title feature to superimpose titles on your videos when recording. There are eight titles preset for your convenience which you can choose from.

- 1 In Recording Standby mode, press the MENU button until  $\frac{4}{5}$  appears.



- 2 Press the TITLE button (◀◀) to display the title selection screen.

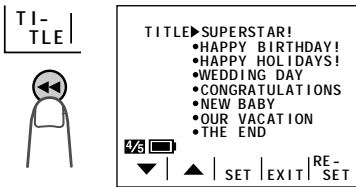

- 3 Press the ▼ or ▲ button (①) to select the desired title, then press the SET button (▶▶) (②) to superimpose it.

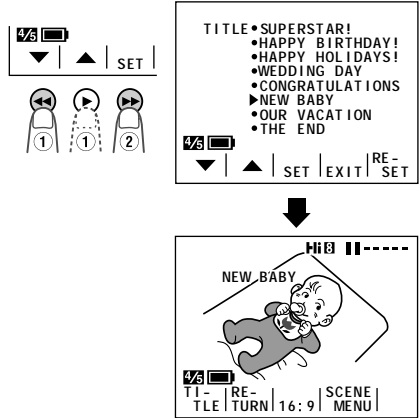

### Notes:

- If you wish to cancel the title selection screen without setting the title, press the EXIT button (■) instead of the SET button.
- If you wish to delete the superimposed title from the screen, press the TITLE button.

- 4 Press the REC START/STOP button to begin recording with the title.
  - The title will be displayed and recorded for about 10 seconds after recording begins.

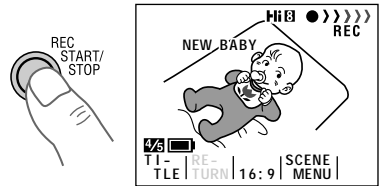

### Note:

- When the title is displayed on the screen, the date and time will not be displayed or recorded.

## Changing the Preset Titles

You can make a new title of your own by changing any of the eight preset titles. The maximum number of title characters is fifteen.

**Example:** Changing "WEDDING DAY" to "IN HAWAII".

- 1 Press the MENU button until  $\frac{4}{3}$  appears, and then press the TITLE button ( $\leftarrow$ ) to display the title selection screen.

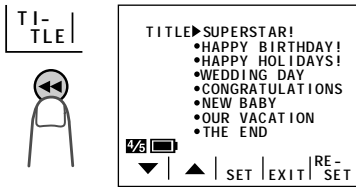

- 2 Press the  $\nabla$  or  $\blacktriangle$  button to select the title that you wish to change.

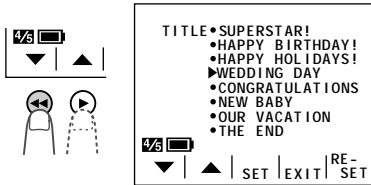

**Note:** If you want to cancel the title selection screen, press the EXIT button ( $\blacksquare$ ).

- 3 Press the RESET button ( $\parallel$ ) to display the title input screen.



- 4 Press the  $\blacktriangleright$  or  $\blacktriangleleft$  button (1) to select the desired character (or " " for space) and press the SELECT button ( $\blacksquare$ ) (2).
  - The selected character will appear at the top of the screen and the cursor will automatically move to the right.

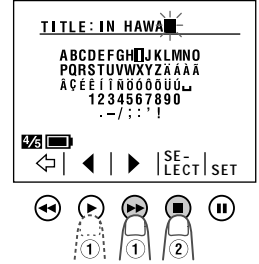

**Note:** If you input the wrong character, press the  $\leftarrow$  button to move the cursor to that character and perform step 4.

- 5 Repeat step 4 until you finish the title, then press the SET button ( $\parallel$ ). The new title will be displayed on the title selection screen.

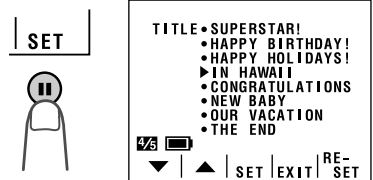

**Note:** To change another title, perform steps 2 to 5 again.

- 6 If you wish to record the new title immediately, press the SET button ( $\blacktriangleright$ ). If you wish to record the new title at a later time, press the EXIT button ( $\blacksquare$ ) to go back to the normal  $\frac{4}{3}$  screen.

# Auto/Manual Focus

## Auto Focus









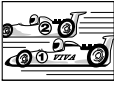

The auto focus function is designed to focus on most types of subjects. In Auto Focus mode, the VIEWCAM automatically focuses on whatever is in the center of the scene. Always keep the subject in the center of the screen.

### Notes:

- If no subject is in the center of the screen, the focus area will expand and the subject nearest the center will be focused on.
- If no subject is displayed on the screen, the VIEWCAM will automatically zoom out until a subject comes into the frame.

## Manual Focus

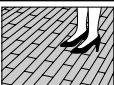
The Auto Focus may not be able to focus on the subject in the situations shown below. In such situations, set the VIEWCAM to Manual Focus mode and focus manually.

	
Subject is too dark.	Lack of contrast, e.g. snow scene.
	
Fast-moving subject.	Background is too bright.
	
Subject has horizontal stripes.	Subject is being shot through a dirty or wet window.
	
Light reflects off the subject.	Two subjects at different distances overlap in the same scene.
	
Subject has fine, repeated patterns.	Subjects at different distances appear in the center of the scene at the same time.

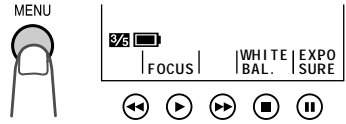

- 1 In Recording Standby mode, press the MENU button until  appears.

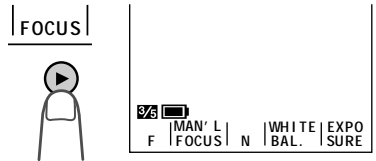

- 2 Press the FOCUS button () to set the VIEWCAM to Manual Focus mode ("MAN'L FOCUS").



- 3 Push the Power Zoom control to frame the subject as you desire.

- 4 Press the F () or N () button to focus on the subject.



## To cancel Manual Focus mode

Perform step 1 above, and press the  button to set the VIEWCAM to Auto Focus mode ("FOCUS").

### Notes:

- The VIEWCAM may not be able to focus correctly if the subject is within approximately 5 feet (1.5 m). Set the zoom control to wide angle, and then try refocusing.
- If the lens is dirty or fogged, the VIEWCAM may not be able to correctly focus.
- The Manual Focus mode will be canceled if the power source is interrupted.

## White Balance Lock

The color of the subject on the screen tends to look different depending on the lighting condition. The VIEWCAM is preset to Auto White Balance mode, which automatically adjusts the hue of the picture for the current lighting condition.

The auto white balance may not work properly for the following subjects. In this case, use the white balance lock function.

- Subjects with one dominant color or subjects against background with one dominant color
- Subjects under very bright light source, e.g. video lights
- Subjects under light source with red hue, e.g. glow of sunset
- Close-up images of small objects

- 1 In Recording Standby mode, press the MENU button until appears.

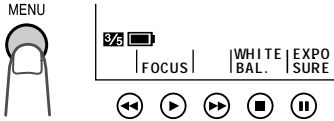

- 2 Aim the lens at a white object.
  - Adjust the distance of the object so that the entire screen is white.

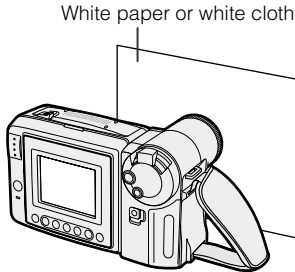

- 3 Press the WHITE BAL. button ( ).
  - “WHITE BAL.” changes from blue to yellow and begins flashing.

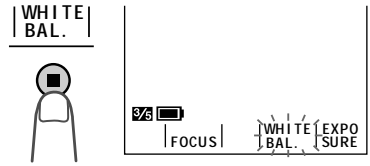

- “WHITE BAL.” stops flashing when the locking procedure is completed.
- 4 Aim the lens at the desired subject and press the REC START/STOP button to begin recording.

### To cancel White Balance Lock

Press the WHITE BAL. button. “WHITE BAL.” returns to blue.

#### Notes:

- If the light source changes or if you move from indoors to outdoors, or vice versa, when recording with the white balance locked, the white balance may shift. Reset the white balance.
- Even after the white balance has been locked, white balance shifts may occur due to slight changes in illumination or depending on the subject.
- Do not move the VIEWCAM while “WHITE BAL.” is flashing in step 3.
- If “WHITE BAL.” does not stop flashing in step 3, press the WHITE BAL. button to cancel the locking procedure and repeat step 3.
- The White Balance Lock will be canceled if the power source is interrupted.
- **The White Balance Lock will be canceled if a scene setting is selected thereafter.**

# Manual Exposure

The VIEWCAM is preset to Auto Exposure mode, which automatically chooses the optimal aperture. When there is too much contrast in brightness between the subject and background, however, you may not be able to record a clear image. In this case, use the manual exposure function to correct the exposure level.

## Background is too bright and subject too dark (backlit subject).

- Increase the exposure level to allow more light through the lens.



## Subject is too bright against background.

- Decrease the exposure level to allow less light through the lens.

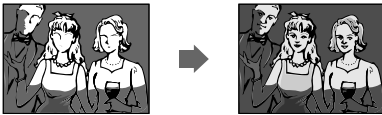

- 1 In Recording Standby mode, press the MENU button until **3/8** appears.

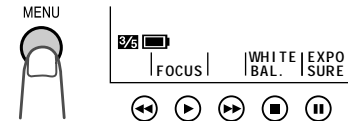

- 2 Press the EXPOSURE button (||) to display the exposure setting screen.

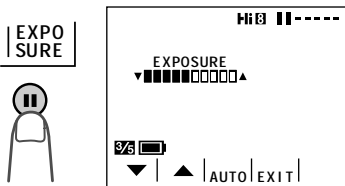

- 3 Press the ▼ or ▲ button to select the desired exposure level.
  - The bar indicates the selected exposure level.

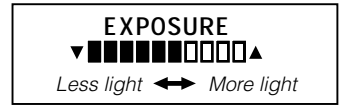
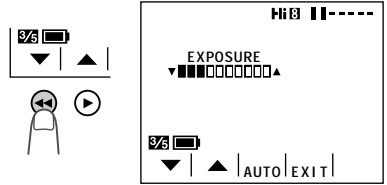

- 4 Press the EXIT button (■) to turn off the exposure setting screen.

## To cancel Manual Exposure mode

Perform steps 1 and 2 above, then press the AUTO button (▶▶).

### Notes:

- The Manual Exposure mode will be canceled if the power source is interrupted.
- **The Manual Exposure mode will be canceled if a scene setting is selected thereafter.**

## Picture/Backlight Adjustments

If the monitor picture is difficult to see due to ambient lighting, etc., adjust the picture settings. This feature can be adjusted in both Camera and VCR modes.

- The example screens for this feature are for Camera mode.

**1** Press the MENU button until  $\frac{5}{6}$  (Camera mode) or  $\frac{5}{3}$  (VCR mode) appears.



**2** Press the PICTURE button (■) to display the adjustment screen. Then press the SELECT button (▶▶) until the item you wish to adjust appears.

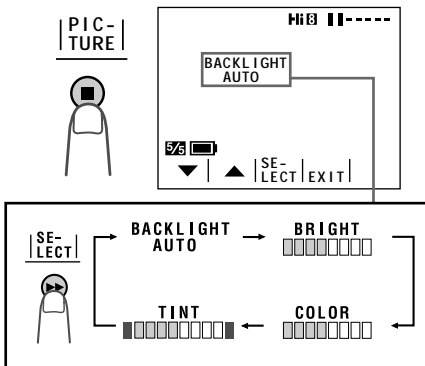

**3** Press the ▼ or ▲ button to adjust the picture or backlight to the desired setting.

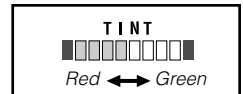
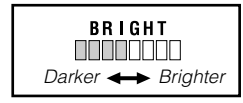
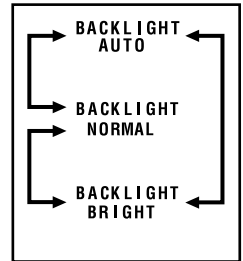
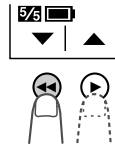

### Type of Backlight Modes

**AUTO:** The VIEWCAM automatically switches between "NORMAL" and "BRIGHT" depending on the ambient lighting. This mode is only available in Camera mode.

**NORMAL:** For use indoors or under moderate lighting conditions.

**BRIGHT:** For use outdoors under strong lighting conditions, such as bright daylight.

**4** Press the EXIT button (■) to turn off the adjustment screen.

### Notes:

- If you set the backlight ("BACKLIGHT") to "AUTO" in Camera mode and then set the VIEWCAM to VCR mode, the backlight mode automatically changes to "NORMAL".
- When the color or tint is adjusted, the picture on the screen may differ from the picture actually recorded. Do not change the color and tint settings unless it is necessary. (These adjustments only affect the monitor picture, not the recorded image.)



## Gamma Playback

The gamma playback function improves the picture by increasing the brightness of the subject while leaving the brighter portions of the image unaffected.

- 1 During playback, press the MENU button until  appears.

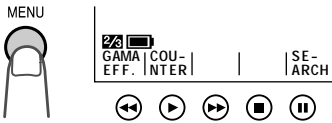

- 2 Press the GAMA EFF. button ()
  - "GAMMA" appears and the picture becomes brighter.

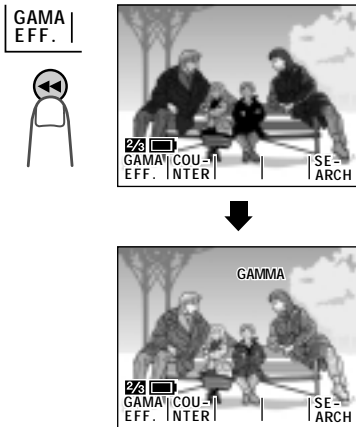

## To cancel Gamma Playback

Press the GAMA EFF. button again. "GAMMA" disappears.

## Turning Off the LCD Monitor Backlight

The LCD monitor uses a fluorescent lamp for backlighting (see page 52). In order to reduce battery consumption, you can turn off the lamp when backlighting is not necessary (e.g. when you are recording a fixed scene).

Hold down the DISPLAY button. Three seconds later, "LCD LAMP OFF" starts flashing on the monitor. Keep the DISPLAY button down for three more seconds, and the backlight will turn off.

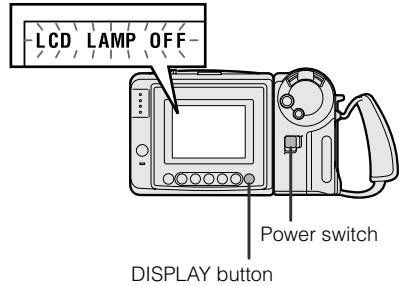

To turn on the backlight again, press the DISPLAY button or set the Power switch to OFF and then back to CAMERA or VCR.

### Note:

- Turning the backlight on and off repeatedly may deplete the battery power.

# Advanced Features

## Editing

Video editing lets you refine your videos by removing unwanted sequences from your tape, or transposing one sequence with another. This VIEWCAM lets you monitor the source program on the built-in LCD monitor without having to connect it to an external TV or video monitor.

Connect the VIEWCAM to a VCR with the supplied audio/video cable, as shown.

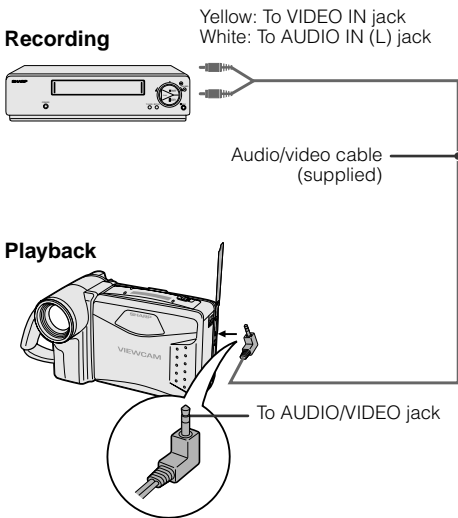

- Press the Pause/Still button on the VCR to pause recording when the source tape reaches the beginning of the sequence to be cut.
- Press the Pause/Still or Record button on the VCR to resume recording when the source tape reaches the end of the sequence to be cut.

### To stop editing

Press the Stop buttons on the VIEWCAM and the VCR.

#### Notes:

- Some of the transitions between edited sequences may be slightly off.
- There may be picture noise during video search or still picture playback. This does not imply a defect in the VIEWCAM.

### Setting Edit Mode

Picture quality inevitably decreases when dubbing from the VIEWCAM to a VCR. To minimize the quality reduction, set the VIEWCAM to Edit mode.

- Set the Power switch to VCR, then press the MENU button until appears.

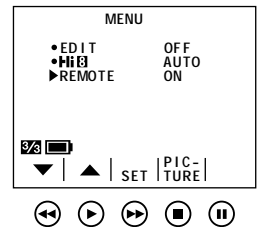

### Cutting Unwanted Sequences

- Play back the tape to be edited, and locate the beginning and end of the sequence you wish to cut. Write down the tape counter readings at the beginning and end of that sequence (see page 37). Then rewind the tape to the beginning of the portion that you wish to keep.
- Load a video cassette into the recording VCR.
- Set the Power switch on the VIEWCAM to VCR. Press the PLAY button (▶) on the VIEWCAM and the Record button on the VCR at the same time.

- Press the ▼ or ▲ button (1) to select "EDIT", then press the SET button (▶▶) (2) to select "ON".

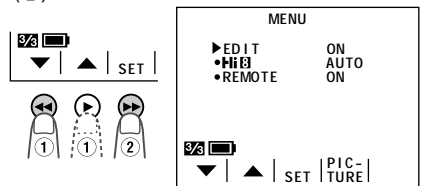

#### Notes:

- The EDIT mode does not function when the VIEWCAM is recording.
- After you finish editing, set the EDIT menu item back to "OFF".

## Useful Information

### Hints for Better Shooting

- Position the subject in the center of the screen. When you are using auto focus, whatever is in the center of the screen is kept in focus.



Position the subject in the center.



Focus manually when you need to position the subject off center (see page 44).

- Avoid backlit subjects. For the best picture, shoot with the light source behind you. When the background is brighter than the subject, the subject often becomes too dark. If you have to record with this lighting, use the Gamma Brightness Compensation or correct the exposure level to improve the picture (see pages 30 and 46).

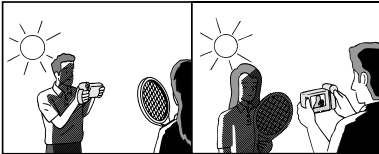

Light from behind      Backlighting

- Before zooming, think about how to best frame the shot. Frequent zooming produces unattractive pictures. It also increases the battery power consumption.
- When image shakes are noticeable during zoomed-in telephoto shooting, use a tripod, or push the Power Zoom control to the W side to zoom out.
- Horizontal panning (lateral movement) and tilting (vertical movement) should be done slowly to emphasize the wide expanse of a scene or the height of a building, and to make scenes easy to watch during playback.
- Use a wide-angle setting for fast-moving subjects.

**Note:**

- It may take longer to focus when zooming and panning are used frequently.

## Lighting

For clear, good-quality recording, 500 to 100,000 lux is needed. Recording is possible with less light, but the picture quality may suffer. Adequate lighting is also essential for correct white balance.

Brightness (Lux)	Situation (Lux)
100,000	Blue sky Clear day at noon (100,000)
10,000	Clear day at 10 am (65,000) Clear day at 3 pm (35,000) Cloudy day at noon (32,000) Cloudy day at 10 am (25,000)
1,000	Cloudy day, one hour after sunrise (2,000) Clear day, one hour before sunset (1,000) Fluorescent light near window (1,000)
100	Factory floor (700–800) Sales counter in department store (500–700) Bowling alley (500) Library (400–500) Office with fluorescent lighting (400–500)
	Fluorescent desk lamp (400) Flashlight at 3 ft (1 m) (250) Shop stairway (100)
10	During intermission at movie theater (15–35) Cigarette lighter at 1 ft (30 cm) (15–20) Candles on birthday cake at 8 inches (20 cm) (10–15) Candlelight

Optimal lighting range

**Note:** The figures in the chart are approximations.

### Tips on Good Lighting

In most outdoor, daytime scenes, natural lighting is adequate for home videos. Indoors, however, artificial lighting is usually required. Video lights with halogen lamps provide the most natural artificial light over a long operating life.

### Dew Formation

#### • What is “dew formation”?

When cold water is poured into a glass, dew drops form on the glass. This clinging of water drops is called dew formation.

#### • When dew forms in your VIEWCAM.

Dew will gradually form on the head drum of your VIEWCAM and make the video tape stick to the head. This causes damage both to the head and the tape. When dew formation occurs, recording and playback may not function properly.

Dew is likely to form in the following circumstances:

- When moving the VIEWCAM from a cold place to a warm place.
- When placing the VIEWCAM in a cold room which is then heated rapidly.
- When moving the VIEWCAM outdoors from an air conditioned room.
- When placing the VIEWCAM in the direct path of air blowing from an air conditioner.
- When placing the VIEWCAM in a humid room.



#### • How to prevent trouble due to dew formation.

When using the VIEWCAM in a place where dew formation is likely to occur, allow the VIEWCAM and the video tape to acclimate to the surroundings for about one hour. For example, when bringing the VIEWCAM indoors after skiing, place it in a plastic bag.

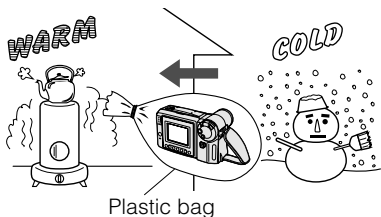

- ① Be sure to tightly seal the plastic bag containing the VIEWCAM.
- ② Remove the bag when the air temperature inside it reaches the temperature of the room.

#### • “DEW” warning feature

If dew forms, the word “DEW” flashes on the LCD monitor, and the power will automatically turn off in approximately 10 seconds.

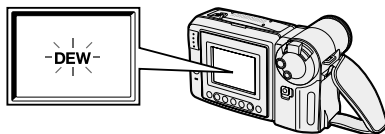

- ① If “DEW” flashes on the LCD monitor, remove the cassette, leave the cassette compartment open, and wait for a few hours to allow the VIEWCAM to acclimate to the surrounding temperature.
- ② To use the VIEWCAM again, turn on the power after waiting for a few hours. Be sure that “DEW” has disappeared from the monitor.
- ③ Do not insert a cassette while “DEW” is flashing; this may result in damage to the tape.
- ④ Since dew forms gradually, it may take 10 to 15 minutes before the dew warning feature engages.

### Dirty Video Heads

Using the VIEWCAM when the video tape is dirty may cause the heads to clog, producing noise on the recorded image or preventing the image from being recorded at all.

If the video heads become clogged, the  indicator appears on the screen. Contact the nearest SHARP service center or your dealer for further advice.

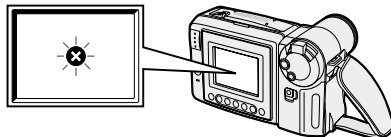

#### Note:

- Video head cleaning can be done by using a commercially-available cleaning tape. However, excessive use of the cleaning tape may also cause damage to the video heads. Please read the instructions accompanying the cleaning tape carefully, before using it.

## Replacing the Fluorescent Lamp

This VIEWCAM uses a fluorescent lamp to backlight the LCD monitor. If the monitor becomes dark or difficult to view, the fluorescent lamp may need to be replaced. Contact the nearest SHARP service center or your dealer for further advice.

## Battery Pack

### Battery pack consumption

- Recording with many starts and stops, frequent zooming, and recording in low temperatures will shorten actual recording times. Accordingly, be sure to turn off the power when not recording. Use of an auxiliary battery pack is recommended to prevent undesirable interruptions in your recording.
- Do not use an insufficiently charged or weak battery pack. Use of such battery packs may cause the power to automatically stop during VIEWCAM operation to protect both the battery pack and the unit.

### Note:

- This VIEWCAM uses a Ni-MH (nickel-metal hydride) type battery pack. Use only the SHARP BT-H22 or BT-H32 battery packs. They are designed specifically for use with this VIEWCAM.

### Battery pack life

**The battery pack has a limited service life. If the period of use becomes noticeably shorter with a normal charge, the battery pack is at the end of its service life. Replace it with a new battery pack.**

### Extending battery pack life

- It is recommended that you use the battery pack until its charge is fully drained and the VIEWCAM is inoperable before recharging the pack.
- Recharge the battery pack right before recording. A battery pack stored for an extended time will naturally wear down, resulting in decreased recording time.
- Do not try to recharge a fully charged battery pack before it has been discharged, as this will cause deterioration of the battery's capacity.
- Store the battery pack in a dry, cool place.

## How to use the battery pack cover

- When storing a fully charged battery pack, put the cover on it so that the "CHARGE" mark printed on the label is seen through the window, as shown.

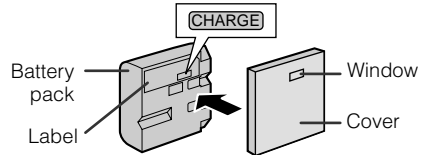

- When storing a battery pack that is not fully charged, put the cover upside down so that only the battery pack casing is seen through the window.

### Caution:

- For safety reasons, put the cover on the battery pack when it is not being used. If the metal parts of the battery pack come in contact with other metal items, there is a danger that a short circuit may occur.

Battery power is consumed even when the VIEWCAM's power is turned off. If you are not going to use your VIEWCAM immediately, remove the battery pack (see page 7).

## Temperature during charging

- The Ni-MH (nickel-metal hydride) type BT-H22 and BT-H32 battery packs can be charged at a temperature of 15°C to 30°C (59°F to 86°F).

### Video Cassette Tapes

Use only tapes with the **Hi 8** or **8** mark with this VIEWCAM.

#### To protect recordings against erasure

When a previously recorded cassette is used again for recording, the previously recorded material is erased. To protect a recording against accidental erasure, slide the tab on the cassette to cover the opening. (A red mark will be exposed.) To record, slide the tab to open the opening.



#### Notes:

- Do not insert anything into the erasure-protection opening in the cassette.
- Do not put anything into the holes on the bottom of the cassette.
- Do not store or place your video tapes in direct sunlight, near heaters, or in places with excessive moisture or dust.
- Do not keep video tapes near magnetic objects as they may erase the recording.
- Do not drop or subject the tapes to excessive shocks.
- Uneven tape winding will damage the tape. If the tape is not properly wound, reinsert it in the VIEWCAM and rewind the tape.
- Store the cassettes in their cases and stand them upright.

### AC Adapter

- The AC adapter may interfere with reception if used near a radio.
- Prevent flammables, liquids, and metal objects from entering the adapter.
- The adapter is a sealed unit. Do not attempt to open or modify it.
- Do not damage, drop, or subject the adapter to vibration.
- Do not leave the adapter in direct sunlight.
- Avoid using the adapter in humid or extremely hot places.

### Cleaning

- Many plastic parts are used in the VIEWCAM casing. Do not use thinner, benzene or other strong chemical cleaners. These may cause discoloration and damage to the casing.
- Clean the casing with a soft, dry cloth. If the casing is particularly dirty, wipe the casing with a tightly wrung cloth dampened with a diluted, neutral detergent. Then wipe it again with a soft, dry cloth.
- Use a soft cloth to wipe finger marks and other soiling off the LCD screen.
- Use a soft cloth, or compressed air and lens paper designed for photographic lenses to clean the lens.

### Using Your VIEWCAM Abroad

Television signal standards and electrical voltages and frequencies vary substantially from country to country. When you are abroad, check the sections below before using the AC adapter or connecting the VIEWCAM to a TV.

#### AC Adapter (Supplied Accessory)

The supplied AC adapter is compatible with 50 Hz and 60 Hz electrical systems in the range of 110 V to 240 V AC.

An AC plug adapter may be required depending on the design of the electrical outlet.

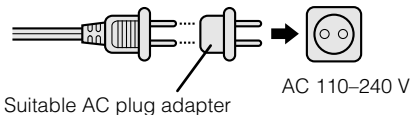

#### Television Signal Standards

In any country, you can always watch the video picture by using the LCD monitor screen. However, if you want to watch the picture on a TV screen, the TV must be NTSC-M system compatible. NTSC-M is used in the following areas:

The Bahamas, Barbados, Bermuda, Myanmar (previously Burma), Canada, Chile, Colombia, Costa Rica, Cuba, the Dominican Republic, Ecuador, El Salvador, Greenland, Guam, Guatemala, Haiti, Honduras, Jamaica, Japan, South Korea, Mexico, the Netherland Antilles, Nicaragua, Panama, Peru, the Philippines, Puerto Rico, St. Kitts, St. Lucia, Surinam, Taiwan, Trinidad, the U.S.A., Venezuela, Southern Vietnam, and the Virgin Islands.

## Demonstration Mode

You can watch a brief demonstration of the special VIEWCAM features in Demo mode. If the demonstration appears on the screen when you turn on the VIEWCAM for the first time, cancel the Demo mode to use your VIEWCAM.

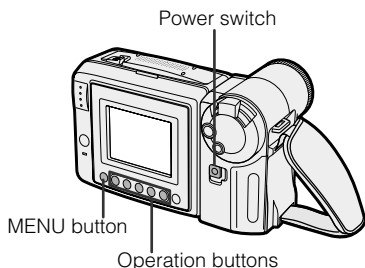

## Watching the Demonstration

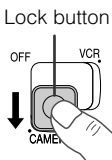
- Make sure that there is no video cassette in the VIEWCAM.
  - If a cassette is in the VIEWCAM, Demo mode does not work. Perform the procedure on page 10 to remove it.
- Hold down the Lock button and slide the Power switch to CAMERA.
 
- Press the MENU button until **5/6** appears.
  - If MENU 2 appears on the **5/6** screen, press the PAGE button (■) to display MENU 1.
- Press ▼ or ▲ (◀ or ▶) button (①) to select "DEMO MODE", then press the SET button (▶▶) (②) to select "ON".
  - The demonstration begins.

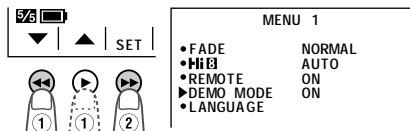

## Canceling Demo Mode

- During the demonstration, perform step 3 above.
- Press ▼ or ▲ button (①) to select "DEMO MODE", then press the SET button (▶▶) (②) to select "OFF".

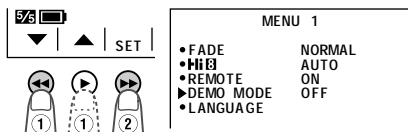

- Press the DISPLAY button to turn off the menu screen.

### Note:

- The demonstration will stop if you press the MENU button. If you leave it for 60 seconds, or turn the power off temporarily and then set the Power switch to CAMERA, the demonstration will begin again.

## References

### Before Requesting Service

Before calling for service, please check the following troubleshooting table.

	Symptom	Possible cause	Suggested solution
Power	No power.	Power source is not properly connected.	Connect power source properly (pp. 7, 9).
		Battery pack is not charged.	Charge battery pack sufficiently (p. 8).
		Dew in VIEWCAM.	Wait until dew dries (p. 51).
		Safety function is in effect.	Set Power switch to OFF and remove battery pack; wait for 2 seconds, then reinstall battery pack and turn on power (p. 7).
CAMERA mode	REC START/STOP button does not work.	Erasure-protect tab on video cassette is closed.	Open tab or use a new cassette (p. 53).
	Power suddenly turns off.	VIEWCAM left in Recording Standby mode for 5 minutes.	Set Power switch to OFF and then back to CAMERA.
	Auto focus does not work.	Manual Focus mode is engaged.	Set to Auto Focus mode (p. 44).
		Zoom used on close subject.	Zoom out from subject (p. 19).
		Subject has little contrast in brightness, or is full of horizontal or vertical stripes.	Focus manually (p. 44).
	Bright subject produces wide vertical lines.	Occurs when shooting subject with strong contrast to the background. Does not indicate a malfunction.	—
	Automatically zooms out without operating Zoom control.	VIEWCAM is unable to focus when zooming in on subject within 5 feet (1.5 m), and automatically zooms out until it focuses on subject.	—
No subject in the field of view.		Direct lens to some subject, or set zoom to widest angle before shooting (p. 19).	
Display automatically changes in Camera mode.	VIEWCAM is in Demo mode.	Set DEMO MODE menu item to "OFF" (p. 54).	
VCR mode	Tape stops during rewind or fast forward.	Counter is in memory mode.	Disengage the memory mode (p. 38).
	No image appears on connected TV screen.	Video input channel on TV or TV channel is not selected properly.	Select video input channel or TV channel properly (p. 22).
		Audio/video cable is not properly connected.	Connect audio/video cable properly (p. 22).



	Symptom	Possible cause	Suggested solution
VCR mode	Cannot play back, rewind or fast forward tape.	Position at beginning or end of tape.	Rewind or fast forward tape to desired point (p. 21).
	Video noise in image.	Dirty video heads.	Call for service (p. 57).
		Old or worn tape.	Use a new cassette.
General	Cassette will not eject.	Power source is not properly connected.	Connect power source properly (pp. 7, 9).
		Battery pack is not charged.	Charge battery pack sufficiently (p. 8).
		VIEWCAM is recording.	Stop tape and try again (p. 18).
	No image on monitor.	Backlight has been turned off.	Turn on backlight (p. 48).
		Fluorescent lamp is burned out.	Call for service (p. 57).
	Monitor picture is hard to see.	Inappropriate picture adjustments.	Adjust picture (p. 47).
	CHARGE indicator flashes in red when charging battery pack.	AC adapter or battery pack may have malfunctioned.	Call for service (p. 57).
	Cannot edit to connected VCR.	Audio/video cable is not properly connected.	Connect audio/video cable properly (p. 49).
	Lens makes rattling sound when VIEWCAM is moved in VCR mode or with power off.	Does not indicate a malfunction.	—
	Remote control does not function.	REMOTE menu item is set to "OFF".	Set REMOTE menu item to "ON" (p. 39).
		Remote control batteries have run down.	Replace remote control batteries with new ones (p. 39).
		Remote control used beyond operating range.	Use remote control within operating range (p. 39).
Intense daylight falling on VIEWCAM remote sensor.		Protect remote sensor from exposure to intense daylight (p. 39).	
Obstacle between remote control and VIEWCAM remote sensor.		Remove obstacle or use remote control from different angle (p. 39).	

**Notes:**

- This unit is equipped with a microprocessor. Its performance could be adversely affected by external electrical noise or interference. If this should happen, turn off the power and disconnect the unit from any power sources, including the lithium battery, etc. Then reconnect the power sources to resume operation.
- If the characters displayed on the monitor screen appear to malfunction, disconnect the power source and remove the lithium battery, then reconnect the power source, insert the lithium battery, and turn the power on again. The characters on the monitor should be normal. Set the date and time, then resume operation.

## References

---

## Specifications

### VIEWCAM

- Signal System: NTSC standard
- Recording System: 2 rotary heads, helical scanning system
  - Cassette: 8 mm video tape, MP type or Hi8 MP, ME type
- Recording/Playback Time: 120 minutes (P6-120)
  - Tape Speed: 14,345 mm/second
- Pickup Device:  $\frac{1}{4}$ " (6.4 mm, effective size: 4.5 mm) CCD image sensor (with approx. 270,000 pixels including optical black)
  - Lens: 16 $\times$  power zoom lens (F1.4,  $f=4.0$ –64.0 mm), and full-range auto focus
- Lens Filter Diameter: 46 mm
  - Monitor: 3" (7.5 cm) full-color LCD screen (TFT active matrix)
- Microphone: Electret monaural microphone
- Color Temperature Compensation: Auto white balance with white balance lock
- Minimum Illumination: 0.8 lux (5 lux measured by EIA standard) (with gain-up, F1.4)
- Video Output Level: 1.0 Vp-p 75-ohm unbalanced
- Audio Output Level: –8 dBs, impedance less than 2.2 kohms
  - Speaker Output: 200 mW
- Power Requirement: DC 3.6 V (with battery pack)
  - DC 7.0 V (with AC adapter)
- Power Consumption: 5.1 W (during camera recording in full auto mode with zoom motor off and backlight in normal mode)
- Operating Temperature: 0°C to +40°C (32°F to 104°F)
  - Operating Humidity: 30% to 80%
- Storage Temperature: –20°C to +60°C (–4°F to 140°F)
- Dimensions (approx.):  $7 \frac{7}{32}$ " (W)  $\times$   $4 \frac{9}{32}$ " (H)  $\times$   $3 \frac{7}{8}$ " (D)  
[183 mm (W)  $\times$  109 mm (H)  $\times$  99 mm (D)]
- Weight (approx.): 1.57 lbs (710 g) (without battery pack, lithium battery, video cassette, and lens cap)

### AC Adapter (UADP-0312TAZZ)

- Power Requirement: AC 110–240 V, 50/60 Hz
  - DC Output: 7.0 V
- Power Consumption: 15 W
- Dimensions (approx.):  $2 \frac{1}{16}$ " (W)  $\times$   $1 \frac{15}{32}$ " (H)  $\times$   $5 \frac{13}{32}$ " (D) [68 mm (W)  $\times$  37 mm (H)  $\times$  137 mm (D)]
- Weight (approx.): 0.68 lbs (308 g)

### Battery Pack (BT-H22)

- DC Output: 3.6 V
- Dimensions (approx.):  $2 \frac{1}{8}$ " (W)  $\times$   $\frac{3}{4}$ " (H)  $\times$   $2 \frac{7}{32}$ " (D) [54 mm (W)  $\times$  19 mm (H)  $\times$  56 mm (D)]
- Weight (approx.): 0.30 lbs (136 g)

Specifications are subject to change without notice.

## SERVICE INFORMATION (For the U.S.)

For the location of the nearest Sharp Authorized Service, or to obtain product literature, accessories, supplies or customer assistance, please call 1-800-BE SHARP (1-800-237-4277) or visit SHARP's website (<http://www.sharp-usa.com>).

# Guía de operación rápida en español

## Inserción y extracción de la batería

### Inserción de la batería

- 1 Asegúrese de que el interruptor de alimentación esté en la posición OFF.

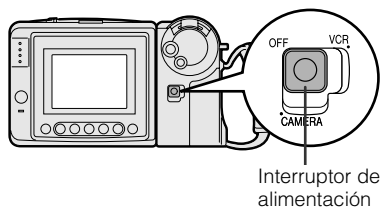

- 2 Deslice el control de apertura de la puerta del compartimiento de la batería, situado en la parte inferior de la VIEWCAM, en la dirección de la flecha para abrir la puerta del compartimiento de la batería.

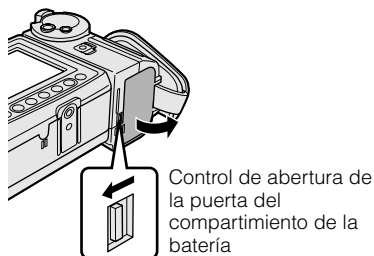

- 3 Introduzca la batería en el compartimiento como se muestra, y empujela completamente hacia adentro hasta que quede bloqueada en su lugar.

#### Precaución:

- No meta a la fuerza la batería en su compartimiento si es que ésta no entra fácilmente.

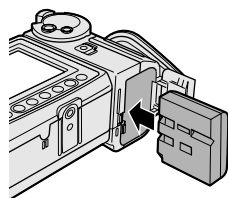

- 4 Cierre la puerta presionándola firmemente en el centro hasta que haga un ruido seco.

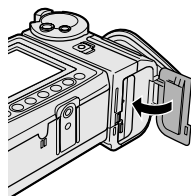

### Extracción de la batería

- 1 Realice los pasos 1 y 2 de arriba.
- 2 Presione el control de liberación de la batería como se muestra para quitar la batería.

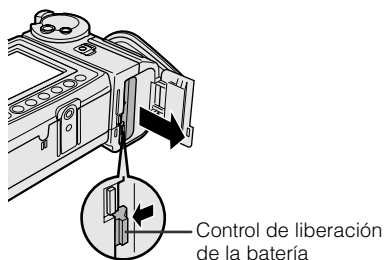

#### Precauciones:

- **ANTES DE QUITAR LA BATERÍA, PARE SIEMPRE LA CINTA Y DESCONECTE LA ALIMENTACIÓN.** Si quita la batería durante la grabación o la reproducción, la cinta quedará enrollada alrededor del tambor de las cabezas de vídeo y tal vez se estropee.
- Asegúrese de cerrar firmemente la puerta del compartimiento de la batería, especialmente durante las operaciones. Si no lo hace así, la batería tal vez se desprenda o la operación de la VIEWCAM puede que falle porque la presión de contacto no será adecuada.
- Quite la batería de la VIEWCAM si la VIEWCAM no va a ser utilizada durante mucho tiempo.
- **Cuando quite la batería, no incline la VIEWCAM para que el compartimiento de la batería quede hacia abajo. La batería podría caerse.**
- No exponga la puerta del compartimiento de la batería a una fuerza excesiva porque podría desprenderse.
- Utilice solamente baterías SHARP modelo BT-H22 o BT-H32 con esta VIEWCAM. La utilización de otras baterías puede causar un riesgo de incendio o explosión.

## Carga de la batería

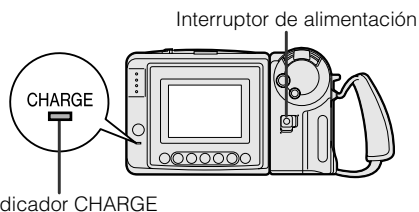

- 1 Inserte la batería en la VIEWCAM (consulte la página 58). Asegúrese de que el interruptor de alimentación esté en la posición OFF.
  - La batería no se carga cuando el interruptor de alimentación está en la posición CAMERA o VCR.

- 2 Inserte la clavija de alimentación de CA del adaptador de CA en una toma de corriente.

- 3 Abra la tapa de terminales de la VIEWCAM e inserte la clavija de CC del adaptador de CA en la toma DC IN de la VIEWCAM.
  - El indicador CHARGE se encenderá en rojo.

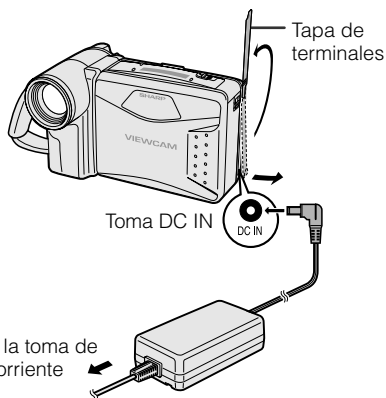

- 4 Cuando la batería esté completamente cargada, el indicador CHARGE se encenderá en verde. Desconecte la clavija de CC de la VIEWCAM y cierre la tapa de terminales.

### Precaución:

- Cuando desconecte las clavijas, sujete las clavijas y tire de ellas, no del cable.

## Selección de idioma para la visualización en pantalla

Esta VIEWCAM le permite elegir el idioma inglés, francés o español para la visualización en pantalla.

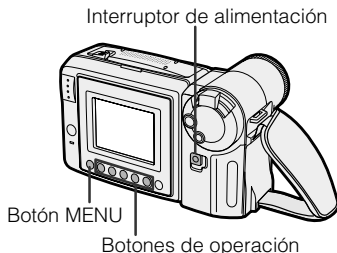

Cuando utilice la VIEWCAM por primera vez, seleccione el idioma deseado en la visualización en pantalla siguiendo el procedimiento de abajo.

- 1 Mantenga pulsado el botón de bloqueo y deslice el interruptor de alimentación hasta CAMERA.
  - La pantalla de selección de idioma aparece.

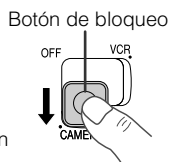

- 2 Pulse el botón  $\blacktriangledown$  o  $\blacktriangle$  ( $\blacktriangleleft$  o  $\blacktriangleright$ ) (1) para seleccionar el idioma deseado, y luego pulse el botón SET (REGLAGE o AJUSTE) ( $\blacktriangleright$ ) (2).

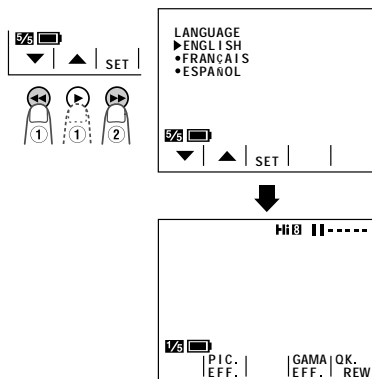

### Notas:

- Los procedimientos de operación de las secciones siguientes de este manual de operación se basan en el uso de visualizaciones en pantalla en inglés.
- Consulte la página 15 para utilizar las visualizaciones en pantalla en español.

## Inserción y extracción de un videocasete

### Inserción de un videocasete

- 1 Suministre alimentación a la VIEWCAM, y luego deslice el control de apertura y abra la puerta del compartimiento del videocasete.

- El portavideocasete se extiende y abre automáticamente.

Control de apertura de la puerta del compartimiento del videocasete



- 2 Inserte completamente el videocasete con la ventanilla hacia afuera y con la lengüeta de protección contra borrado hacia la parte superior.

Lengüeta de protección contra borrado



- 3 Presione suavemente la marca PUSH hasta que el portavideocasete se coloque en su lugar haciendo un ruido seco.

- El portavideocasete se pliega automáticamente.

Marca PUSH

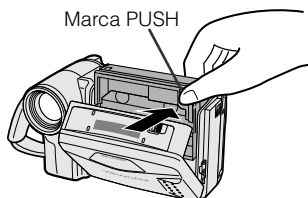

- 4 Espere a que el portavideocasete se pliegue completamente. Cierre la puerta del compartimiento presionando sobre la parte central hasta que se coloque en su lugar haciendo un ruido seco.

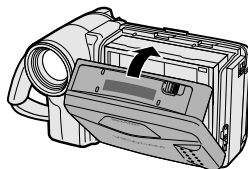

### Extracción de un videocasete

Realice el paso 1 de arriba y luego saque el videocasete.

#### Precauciones:

- No intente cerrar la puerta del compartimiento del videocasete mientras el videocasete se extiende o se pliega.
- Tenga cuidado de no pillarse los dedos en el portavideocasete.
- No aplique fuerza al portavideocasete, excepto cuando presione la marca PUSH para cerrarlo.
- No incline la VIEWCAM ni la tome al revés cuando inserte o extraiga un videocasete. Esto podría estropear la cinta.
- Extraiga el videocasete si no piensa utilizar la VIEWCAM durante mucho tiempo.
- Si no cierra correctamente el portavideocasete en el paso 3 anterior, el mecanismo de protección de la VIEWCAM tal vez expulse el videocasete. Si pasa esto, repita el procedimiento de inserción.
- No intente tomar la VIEWCAM por la puerta del compartimiento del videocasete.

#### Nota:

- Si la energía de la batería es demasiado baja, tal vez no pueda extraer el videocasete. Reemplace la batería por otra completamente cargada.

## Grabación sencilla con videocámara en el modo completamente automático

Antes de empezar a grabar, realice las operaciones descritas en las páginas 58 a 60 para preparar su VIEWCAM para la grabación.

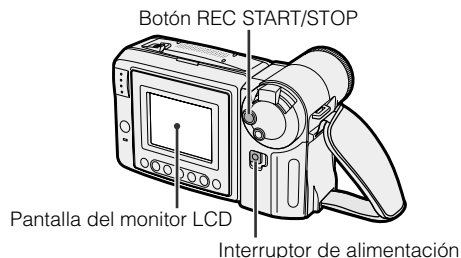

- 1 Quite la tapa del objetivo.
- 2 Mantenga pulsado el botón de bloqueo y deslice el interruptor de alimentación hasta CAMERA.
  - La imagen captada por el objetivo se visualiza en la pantalla del monitor LCD.
  - La VIEWCAM está ahora lista para grabar (modo de espera de grabación).



Indicador del modo completamente automático

**Nota:** Si, en este momento, no aparece "AUTO", ponga la VIEWCAM en el modo completamente automático.

- 3 Pulse el botón REC START/STOP para iniciar la grabación.

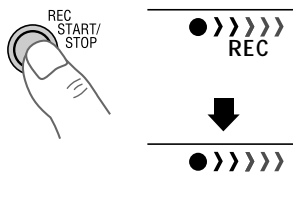

### Nota:

- Cuando grabe al principio de una cinta, avance la cinta unos 15 segundos antes de empezar a grabar. Esto impedirá que el principio de la grabación quede cortado al hacer la reproducción.

### Para hacer una pausa en la grabación

Pulse de nuevo el botón REC START/STOP. La grabación hará una pausa y la VIEWCAM se pondrá en el modo de espera de grabación.

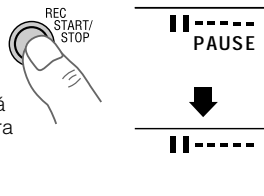

### Para desconectar la alimentación

Deslice el interruptor de alimentación hasta OFF.

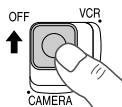

### Notas:

- El altavoz se apaga en el modo de videocámara.
- En el modo de espera de grabación se consume energía de la batería. Desconecte la alimentación si no va a grabar pronto.
- Si la VIEWCAM se deja en el modo de espera de grabación durante más de 5 minutos, la alimentación se desconectará automáticamente para ahorrar energía de la batería y proteger la cinta para que no se estropee. Para continuar grabando después de esto, ponga el interruptor de alimentación en OFF y luego en CAMERA.

### Tiempo máximo de grabación continua y tiempo de grabación real

Batería	Tiempo máximo de grabación continua	Tiempo de grabación real
BT-H22	1 hr y 35 min aprox.	45 min aprox.
BT-H32	3 hr y 10 min aprox.	1 hr y 30 min aprox.

### Nota:

- La utilización del zoom y otras funciones o la conexión y la desconexión frecuente de la alimentación aumentarán el consumo de energía. Esto puede causar una reducción de más del 50% en el tiempo de grabación real si se compara con el tiempo máximo de grabación continua indicado arriba.

## Reproducción

La pantalla del monitor LCD hace posible reproducir y ver lo que usted acaba de grabar. No es necesario conectar nada, pudiéndose realizar la reproducción instantánea en pantalla oyendo el sonido a través del altavoz incorporado.

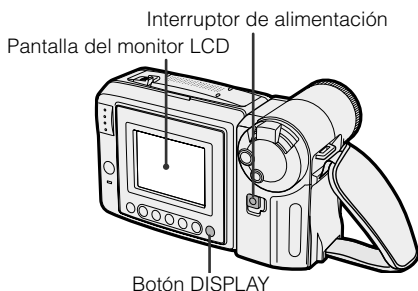

- 1 Mantenga pulsado el botón de bloqueo y deslice el interruptor de alimentación hasta VCR.

- Aparece la pantalla

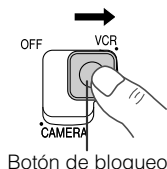

- 2 Pulse el botón REW (◀◀) (o FF [▶▶]) para rebobinar (o avanzar rápidamente) la cinta hasta el punto deseado.



- 3 Pulse el botón PLAY (▶) para iniciar la reproducción.



## Para detener la reproducción

Pulse el botón STOP (■).



### Notas:

- Si desea encender o apagar los indicadores de los botones de operación, pulse el botón DISPLAY. Los botones de operación de reproducción seguirán funcionando como se ha indicado incluso después de apagarse los indicadores.
- Para utilizar el control remoto por infrarrojos, asegúrese de que el ítem del menú REMOTE esté en "ON".

## Rebobinado automático de la cinta

La cinta se rebobinará automáticamente cuando llegue al final durante la reproducción.

## Para desconectar la alimentación

Deslice el interruptor de alimentación hasta OFF.

## Control de volumen

Mientras la VIEWCAM está en el modo de vídeo, empuje el control de volumen hacia el lado + o - para aumentar (①) o disminuir (②) el volumen según sus preferencias.

El indicador de nivel del sonido aparecerá en la pantalla durante el ajuste solamente. Cuando se suelte el control de volumen, el indicador de nivel del sonido desaparecerá poco después.

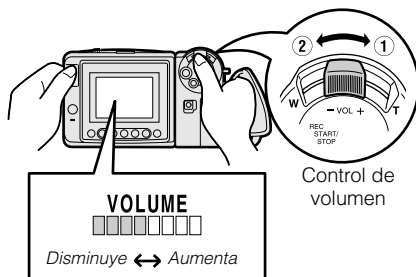

**CONSUMER LIMITED WARRANTY**

SHARP ELECTRONICS CORPORATION warrants to the first consumer purchaser that this Sharp brand product (the "Product"), when shipped in its original container, will be free from defective workmanship and materials, and agrees that it will, at its option, either repair the defect or replace the defective Product or part thereof with a new or remanufactured equivalent at no charge to the purchaser for parts or labor for the period(s) set forth below.

This warranty does not apply to any appearance items of the Product nor to the additional excluded item(s) set forth below nor to any Product the exterior of which has been damaged or defaced, which has been subjected to improper voltage or other misuse, abnormal service or handling, or which has been altered or modified in design or construction.

In order to enforce the rights under this limited warranty, the purchaser should follow the steps set forth below and provide proof of purchase to the servicer.

The limited warranty described herein is in addition to whatever implied warranties may be granted to purchasers by law. ALL IMPLIED WARRANTIES INCLUDING THE WARRANTIES OF MERCHANTABILITY AND FITNESS FOR USE ARE LIMITED TO THE PERIOD(S) FROM THE DATE OF PURCHASE SET FORTH BELOW. Some states do not allow limitations on how long an implied warranty lasts, so the above limitation may not apply to you.

Neither the sales personnel of the seller nor any other person is authorized to make any warranties other than those described herein, or to extend the duration of any warranties beyond the time period described herein on behalf of Sharp.

The warranties described herein shall be the sole and exclusive warranties granted by Sharp and shall be the sole and exclusive remedy available to the purchaser. Correction of defects, in the manner and for the period of time described herein, shall constitute complete fulfillment of all liabilities and responsibilities of Sharp to the purchaser with respect to the Product, and shall constitute full satisfaction of all claims, whether based on contract, negligence, strict liability or otherwise. In no event shall Sharp be liable, or in any way responsible, for any damages or defects in the Product which were caused by repairs or attempted repairs performed by anyone other than an authorized servicer. Nor shall Sharp be liable or in any way responsible for any incidental or consequential economic or property damage. Some states do not allow the exclusion of incidental or consequential damages, so the above exclusion may not apply to you.

THIS WARRANTY GIVES YOU SPECIFIC LEGAL RIGHTS. YOU MAY ALSO HAVE OTHER RIGHTS WHICH VARY FROM STATE TO STATE.

**Model Specific Section****Your Product Model****Number & Description:**

VL-AH130U Camcorder

(Be sure to have this information available when you need service for your Product.)

**Warranty Period for this Product:**

One (1) year parts and ninety (90) days labor from date of purchase except for the rechargeable battery incorporated in this Product which is warranted for thirty (30) days from date of purchase.

**Additional Item(s) Excluded from Warranty Coverage (if any):**

Non-rechargeable batteries.

**Where to Obtain Service:**

From a Sharp Authorized Servicer located in the United States. To find the location of the nearest Sharp Authorized Servicer, call Sharp toll free at 1-800-BE-SHARP.

**What to do to Obtain Service:**

Ship prepaid or carry in your Product to a Sharp Authorized Servicer. Be sure to have **Proof of Purchase** available. If you ship the Product, be sure it is insured and packaged securely.

TO OBTAIN SUPPLY, ACCESSORY OR PRODUCT INFORMATION, GO TO OUR WEBSITE AT [www.sharp-usa.com](http://www.sharp-usa.com) OR CALL 1-800-BE-SHARP

**SHARP®****SHARP ELECTRONICS CORPORATION**

Sharp Plaza, Mahwah, New Jersey 07430-2135

**SHARP CORPORATION**

Osaka, Japan

Printed in Malaysia  
TINSE0398TAZZ  
01P02-M-G