

# **XV6900**

# **User Manual**

smartphone

## Please Read Before Proceeding

**THE BATTERY IS NOT CHARGED WHEN YOU TAKE IT OUT OF THE BOX.**

**DO NOT REMOVE THE BATTERY PACK WHEN THE DEVICE IS CHARGING.**



**YOUR WARRANTY IS INVALIDATED IF YOU OPEN OR TAMPER WITH THE DEVICE'S OUTER CASING.**

### PRIVACY RESTRICTIONS

Some countries require full disclosure of recorded telephone conversations, and stipulate that you must inform the person with whom you are speaking that the conversation is being recorded. Always obey the relevant laws and regulations of your country when using the recording feature of your device.

### INTELLECTUAL PROPERTY RIGHT INFORMATION

Copyright © 2007 High Tech Computer Corp. All Rights Reserved.

 ,  HTC ,  HTC , ExtUSB, HTC Touch, TouchFLO, and HTC Care are trademarks and/or service marks of High Tech Computer Corp.

Microsoft, MS-DOS, Windows, Windows NT, Windows Server, Windows Mobile, Windows XP, Windows Vista, ActiveSync, Windows Mobile Device Center, Internet Explorer, Windows Live, MSN, Hotmail, Outlook, Excel, PowerPoint, Word, and Windows Media are either registered trademarks or trademarks of Microsoft Corporation in the United States and/or other countries.

Bluetooth and the Bluetooth logo are trademarks owned by Bluetooth SIG, Inc.

microSD is a trademark of SD Card Association.

Copyright © 2007, Adobe Systems Incorporated.

Copyright © 2007, Macromedia Netherlands, B.V.

Macromedia, Flash, Macromedia Flash, Macromedia Flash Lite and Reader are trademarks and/or registered trademarks of Macromedia Netherlands, B.V. or Adobe Systems Incorporated.

Copyright © 2007, JATAAYU SOFTWARE (P) LTD. All Rights Reserved.

Copyright © 2007, Dilithium Networks, Inc. All Rights Reserved.

Copyright © 2007, Tao Group Limited. All Rights Reserved.

ArcSoft MMS Composer™ Copyright © 2003-2007, ArcSoft, Inc. and its licensors. All Rights Reserved. ArcSoft and the ArcSoft logo are registered trademarks of ArcSoft, Inc. in the United States and/or other countries.

Licensed by QUALCOMM Incorporated under one or more of the following patents:

4,901,307	5,490,165	5,056,109	5,504,773	5,101,501	5,778,338
5,506,865	5,109,390	5,511,073	5,228,054	5,535,239	5,710,784
5,267,261	5,544,196	5,267,262	5,568,483	5,337,338	5,659,569
5,600,754	5,414,796	5,657,420	5,416,797		

All other company, product and service names mentioned herein are trademarks, registered trademarks or service marks of their respective owners.

HTC shall not be liable for technical or editorial errors or omissions contained herein, nor for incidental or consequential damages resulting from furnishing this material. The information is provided "as is" without warranty of any kind and is subject to change without notice. HTC also reserves the right to revise the content of this document at any time without prior notice.

No part of this document may be reproduced or transmitted in any form or by any means, electronic or mechanical, including photocopying, recording or storing in a retrieval system, or translated into any language in any form without prior written permission of HTC.

## Disclaimers

THE WEATHER INFORMATION, DATA AND DOCUMENTATION ARE PROVIDED “AS IS” AND WITHOUT WARRANTY OR TECHNICAL SUPPORT OF ANY KIND FROM HTC. TO THE MAXIMUM EXTENT PERMITTED BY APPLICABLE LAW, HTC AND ITS AFFILIATES expressly disclaim any and all representations and warranties, express or implied, arising by law or otherwise, regarding the Weather Information, Data, Documentation, or any other Products and services, including without limitation any express or implied warranty of merchantability, express or implied warranty of fitness for a particular purpose, non-infringement, quality, accuracy, completeness, effectiveness, reliability, usefulness, that the Weather Information, Data and/or Documentation will be error-free, or implied warranties arising from course of dealing or course of performance.

Without limiting the foregoing, it is further understood that HTC and its Providers are not responsible for Your use or misuse of the Weather Information, Data and/or Documentation or the results from such use. HTC and its Providers make no express or implied warranties, guarantees or affirmations that weather information will occur or has occurred as the reports, forecasts, data, or information state, represent or depict and it shall have no responsibility or liability whatsoever to any person or entity, parties and non-parties alike, for any inconsistency, inaccuracy, or omission for weather or events predicted or depicted, reported, occurring or occurred. WITHOUT LIMITING THE GENERALITY OF THE FOREGOING, YOU ACKNOWLEDGE THAT THE WEATHER INFORMATION, DATA AND/OR DOCUMENTATION MAY INCLUDE INACCURACIES AND YOU WILL USE COMMON SENSE AND FOLLOW STANDARD SAFETY PRECAUTIONS IN CONNECTION WITH THE USE OF THE WEATHER INFORMATION, DATA OR DOCUMENTATION.

## Limitation of Damages

TO THE MAXIMUM EXTENT PERMITTED BY APPLICABLE LAW, IN NO EVENT SHALL HTC OR ITS PROVIDERS BE LIABLE TO USER OR ANY THIRD PARTY FOR ANY INDIRECT, SPECIAL, CONSEQUENTIAL, INCIDENTAL OR PUNITIVE DAMAGES OF ANY KIND, IN CONTRACT OR TORT, INCLUDING, BUT NOT LIMITED TO, INJURY, LOSS OF REVENUE, LOSS OF GOODWILL, LOSS OF BUSINESS OPPORTUNITY, LOSS OF DATA, AND/OR LOSS OF PROFITS ARISING OUT OF, OR RELATED TO, IN ANY MANNER, OR THE DELIVERY, PERFORMANCE OR NONPERFORMANCE OF OBLIGATIONS, OR USE OF THE WEATHER INFORMATION, DATA OR DOCUMENTATION HEREUNDER REGARDLESS OF THE FORESEEABILITY THEREOF.

## Important Health Information and Safety Precautions

When using this product, the safety precautions below must be taken to avoid possible legal liabilities and damages.

Retain and follow all product safety and operating instructions. Observe all warnings in the operating instructions on the product.

To reduce the risk of bodily injury, electric shock, fire and damage to the equipment, observe the following precautions.

### **ELECTRICAL SAFETY**

This product is intended for use when supplied with power from the designated battery or power supply unit. Other usage may be dangerous and will invalidate any approval given to this product.

### **SAFETY PRECAUTIONS FOR PROPER GROUNDING INSTALLATION**

**CAUTION:** Connecting to improperly grounded equipment can result in an electric shock to your device.

This product is equipped with a USB Cable for connecting with desk-top or notebook computer. Be sure your computer is properly grounded (earthed) before connecting this product to the computer. The power supply cord of a desktop or notebook computer has an equipment-grounding conductor and a grounding plug. The plug must be plugged into an appropriate outlet which is properly installed and grounded in accordance with all local codes and ordinances.

## SAFETY PRECAUTIONS FOR POWER SUPPLY UNIT

- **Use the correct external power source**

A product should be operated only from the type of power source indicated on the electrical ratings label. If you are not sure of the type of power source required, consult your authorized service provider or local power company. For a product that operates from battery power or other sources, refer to the operating instructions that are included with the product.

- **Handle battery packs carefully**

This product contains a Li-ion battery. There is a risk of fire and burns if the battery pack is handled improperly. Do not attempt to open or service the battery pack. Do not disassemble, crush, puncture, short external contacts or circuits, dispose of in fire or water, or expose a battery pack to temperatures higher than 60°C (140°F).



**WARNING:** Danger of explosion if battery is incorrectly replaced. To reduce risk of fire or burns, do not disassemble, crush, puncture, short external contacts, expose to temperature above 60°C (140°F), or dispose of in fire or water. Replace only with specified batteries. Recycle or dispose of used batteries according to the local regulations or reference guide supplied with your product.



- **Take extra precautions**

- Keep the battery or device dry and away from water or any liquid as it may cause a short circuit.
- Keep metal objects away so they don't come in contact with the battery or its connectors as it may lead to short circuit during operation.
- Do not use a battery that appears damaged, deformed, or discolored, or the one that has any rust on its casing, overheats, or emits a foul odour.
- Always keep the battery out of the reach of babies and small children, to avoid swallowing of the battery. Consult the doctor immediately if the battery is swallowed.
- If the battery leaks:
  - Do not allow the leaking fluid to come in contact with skin or clothing. If already in contact, flush the affected area immediately with clean water and seek medical advice.
  - Do not allow the leaking fluid to come in contact with eyes. If already in contact, DO NOT rub; rinse with clean water immediately and seek medical advice.
  - Take extra precautions to keep a leaking battery away from fire as there is a danger of ignition or explosion.
- Communicate the appropriate steps immediately in case a hazard occurs.

## SAFETY PRECAUTIONS FOR DIRECT SUNLIGHT

Keep this product away from excessive moisture and extreme temperatures. Do not leave the product or its battery inside a vehicle or in places where the temperature may exceed 60°C (140°F), such as on a car dashboard, window sill, or behind a glass that is exposed to direct sunlight or strong ultraviolet light for extended periods of time. This may damage the product, overheat the battery, or pose a risk to the vehicle.

## PREVENTION OF HEARING LOSS

### Caution: Avoid potential hearing loss

Prolonged exposure to loud sounds (including music) is the most common cause of preventable hearing loss. Some scientific research suggests that using portable audio devices, such as portable music players and cellular telephones, at high volume settings for long durations may lead to permanent noise-induced hearing loss. This includes the use of headphones (including headsets, earbuds and Bluetooth® or other wireless devices). Exposure to very loud sound has also been associated in some studies with tinnitus (a ringing in the

ear), hypersensitivity to sound and distorted hearing. Individual susceptibility to noise-induced hearing loss and other potential hearing problems varies.

The amount of sound produced by a portable audio device varies depending on the nature of the sound, the device, the device settings and the headphones. You should follow some commonsense recommendations when using any portable audio device:

- Set the volume in a quiet environment and select the lowest volume at which you can hear adequately.
- When using headphones, turn the volume down if you cannot hear the people speaking near you or if the person sitting next to you can hear what you are listening to.
- Do not turn the volume up to block out noisy surroundings. If you choose to listen to your portable device in a noisy environment, use noise-cancelling headphones to block out background environmental noise.
- Limit the amount of time you listen. As the volume increases, less time is required before your hearing could be affected.
- Avoid using headphones after exposure to extremely loud noises, such as rock concerts, that might cause temporary hearing loss. Temporary hearing loss might cause unsafe volumes to sound normal.
- Do not listen at any volume that causes you discomfort. If you experience ringing in your ears, hear muffled speech or experience any temporary hearing difficulty after listening to your portable audio device, discontinue use and consult your doctor.

**You can obtain additional information on this subject from the following sources:**

American Academy of Audiology  
 11730 Plaza American Drive, Suite 300  
 Reston, VA 20190  
 Voice: **(800) 222-2336**  
 Email: [info@audiology.org](mailto:info@audiology.org)  
 Internet: **[www.audiology.org](http://www.audiology.org)**

National Institute on Deafness and Other Communication Disorders  
 National Institutes of Health  
 31 Center Drive, MSC 2320  
 Bethesda, MD USA 20892-2320  
 Voice: **(301) 496-7243**  
 Email: [nidcdinfo@nih.gov](mailto:nidcdinfo@nih.gov)  
 Internet: **<http://www.nidcd.nih.gov/health/hearing>**

National Institute for Occupational Safety and Health  
 Hubert H. Humphrey Bldg.  
 200 Independence Ave., SW  
 Washington, DC 20201  
 Voice: **1-800-35-NIOSH (1-800-356-4674)**  
 Internet: **<http://www.cdc.gov/niosh/topics/noise/default.html>**

## **SAFETY IN AIRCRAFT**

Due to the possible interference caused by this product to an aircraft's navigation system and its communications network, using this device's phone function on board an airplane is against the law in most countries. If you want to use this device when on board an aircraft, remember to turn off the phone by switching to Airplane Mode.

## **ENVIRONMENT RESTRICTIONS**

Do not use this product in gas stations, fuel depots, chemical plants or where blasting operations are in progress, or in potentially explosive atmospheres such as fuelling areas, fuel storehouses, below deck on boats, fuel or chemical transfer or storage facilities, and areas where the air contains chemicals or particles, such as grain, dust, or metal powders. Please be aware that sparks in such areas could cause an explosion or fire resulting in bodily injury or even death.

## **EXPLOSIVE ATMOSPHERES**

When in any area with a potentially explosive atmosphere or where flammable materials exist, the product should be turned off and the user should obey all signs and instructions. Sparks in such areas could cause an explosion or fire resulting in bodily injury or even death. Users are advised not to use the equipment at refuelling points such as service or gas stations, and are reminded of the need to observe restrictions on the use of radio equipment in fuel depots, chemical plants, or where blasting operations are in progress. Areas with a potentially explosive atmosphere are often, but not always, clearly marked. These include fuelling areas, below deck on boats, fuel or chemical transfer or storage facilities, and areas where the air contains chemicals or particles, such as grain, dust, or metal powders.

## **ROAD SAFETY**

Vehicle drivers in motion are not permitted to use telephony services with handheld devices, except in the case of emergency. In some countries, using hands-free devices as an alternative is allowed.

## **SAFETY PRECAUTIONS FOR RF EXPOSURE**

- Avoid using your device near metal structures (for example, the steel frame of a building).
- Avoid using your device near strong electromagnetic sources, such as microwave ovens, sound speakers, TV and radio.
- Use only original manufacturer-approved accessories, or accessories that do not contain any metal.
- Use of non-original manufacturer-approved accessories may violate your local RF exposure guidelines and should be avoided.

## **INTERFERENCE WITH MEDICAL EQUIPMENT FUNCTIONS**

This product may cause medical equipment to malfunction. The use of this device is forbidden in most hospitals and medical clinics.

If you use any other personal medical device, consult the manufacturer of your device to determine if it is adequately shielded from external RF energy. Your physician may be able to assist you in obtaining this information.

Turn the phone OFF in health care facilities when any regulations posted in these areas instruct you to do so. Hospitals or health care facilities may be using equipment that could be sensitive to external RF energy.

## **HEARING AIDS**

Some digital wireless phones may interfere with some hearing aids. In the event of such interference, you may want to consult your service provider, or call the customer service line to discuss alternatives.

## NONIONIZING RADIATION

Your device has an internal antenna. This product should be operated in its normal-use position to ensure the radiative performance and safety of the interference. As with other mobile radio transmitting equipment, users are advised that for satisfactory operation of the equipment and for the safety of personnel, it is recommended that no part of the human body be allowed to come too close to the antenna during operation of the equipment.

Use only the supplied integral antenna. Use of unauthorized or modified antennas may impair call quality and damage the phone, causing loss of performance and SAR levels exceeding the recommended limits as well as result in non-compliance with local regulatory requirements in your country.

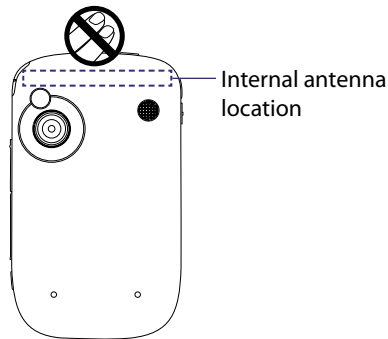

To assure optimal phone performance and ensure human exposure to RF energy is within the guidelines set forth in the relevant standards, always use your device only in its normal-use position. Do not touch or hold the antenna area unnecessarily when placing or receiving a phone call. Contact with the antenna area may impair call quality and cause your device to operate at a higher power level than needed. Avoiding contact with the antenna area when the phone is IN USE optimizes the antenna performance and the battery life.

## General Precautions

- **Heed service markings**

Except as explained elsewhere in the Operating or Service documentation, do not service any product yourself. Service needed on components inside these compartments should be done by an authorized service technician or provider.

- **Damage requiring service**

Unplug the product from the electrical outlet and refer servicing to an authorized service technician or provider under the following conditions:

- Liquid has been spilled or an object has fallen into the product.
- The product has been exposed to rain or water.
- The product has been dropped or damaged.
- There are noticeable signs of overheating.
- The product does not operate normally when you follow the operating instructions.

- **Avoid hot areas**

The product should be placed away from heat sources such as radiators, heat registers, stoves, or other products (including, but not limited to, amplifiers) that produce heat.

- **Avoid wet areas**

Never use the product in a wet location.

- **Avoid using your device after a dramatic change in temperature**

When you move your device between environments with very different temperature and/or humidity ranges, condensation may form on or within the device. To avoid damaging the device, allow sufficient time for the moisture to evaporate before using the device.

**Note** When taking the device from low-temperature conditions into a warmer environment or from high-temperature conditions into a cooler environment, allow the device to acclimate to room temperature before turning on power.

- **Avoid pushing objects into product**  
Never push objects of any kind into cabinet slots or other openings in the product. Slots and openings are provided for ventilation. These openings must not be blocked or covered.
- **Mounting accessories**  
Do not use the product on an unstable table, cart, stand, tripod, or bracket. Any mounting of the product should follow the manufacturer's instructions, and should use a mounting accessory recommended by the manufacturer.
- **Avoid unstable mounting**  
Do not place the product with an unstable base.
- **Use product with approved equipment**  
This product should be used only with personal computers and options identified as suitable for use with your equipment.
- **Adjust the volume**  
Turn down the volume before using headphones or other audio devices.
- **Cleaning**  
Unplug the product from the wall outlet before cleaning. Do not use liquid cleaners or aerosol cleaners. Use a damp cloth for cleaning, but NEVER use water to clean the LCD screen.



# Contents

<b>Chapter 1</b>	<b>Getting Started</b>	<b>13</b>
1.1	Getting to Know Your XV6900 and Accessories .....	14
1.2	The Battery and the Storage Card .....	17
1.3	Starting Up .....	20
1.4	The Today Screen .....	21
1.5	TouchFLO™ .....	25
1.6	Programs .....	30
1.7	Settings.....	31
<b>Chapter 2</b>	<b>Entering and Searching Information</b>	<b>35</b>
2.1	Entering Information.....	36
2.2	Using the On-screen Keyboard.....	36
2.3	Using Touch Keypad or Touch Keyboard.....	37
2.4	Using Letter Recognizer .....	38
2.5	Using Block Recognizer .....	39
2.6	Using Transcriber .....	39
2.7	Searching Information .....	40
<b>Chapter 3</b>	<b>Using Phone Features</b>	<b>41</b>
3.1	Using the Phone.....	42
3.2	Making a Call.....	43
3.3	Receiving a Call .....	44
3.4	Smart Dialing .....	46
3.5	Additional Dialing Information .....	47
<b>Chapter 4</b>	<b>Setting Up Your XV6900</b>	<b>49</b>
4.1	Basic Settings .....	50
4.2	Personalizing the Today Screen.....	52
4.3	Customizing Phone Services.....	54
4.4	Protecting Your XV6900 .....	55
<b>Chapter 5</b>	<b>Synchronizing Information With Your Computer</b>	<b>57</b>
5.1	About Synchronization .....	58
5.2	Setting Up Windows Mobile® Device Center on Windows Vista® .....	58
5.3	Setting Up ActiveSync® on Windows XP® .....	60

5.4	Synchronizing With Your Computer .....	61
5.5	Synchronizing via Bluetooth .....	62
5.6	Synchronizing Music and Video .....	62
<b>Chapter 6</b>	<b>Organizing Contacts, Appointments, Tasks, and Other Information</b>	<b>63</b>
6.1	Contacts.....	64
6.2	Calendar .....	66
6.3	Tasks .....	68
6.4	Notes.....	69
6.5	Voice Recorder .....	70
<b>Chapter 7</b>	<b>Exchanging Messages</b>	<b>71</b>
7.1	Messaging .....	72
7.2	Text Messages .....	73
7.3	MMS Messages.....	74
7.4	Setting Up E-mail Accounts.....	78
7.5	Using E-mail .....	80
<b>Chapter 8</b>	<b>Working With Company E-mail and Meeting Appointments</b>	<b>85</b>
8.1	Synchronizing Your XV6900 with the Exchange Server .....	86
8.2	Working With Company E-mail .....	87
8.3	Managing Meeting Requests .....	90
8.4	Finding Contacts in the Company Directory .....	91
8.5	E-mail Security .....	92
<b>Chapter 9</b>	<b>Working With Documents and Files</b>	<b>95</b>
9.1	Microsoft® Office Word Mobile .....	96
9.2	Microsoft® Office Excel® Mobile.....	96
9.3	Microsoft® Office PowerPoint® Mobile.....	97
9.4	Adobe Reader LE.....	97
9.5	Copying and Managing Files .....	99
9.6	ZIP .....	100
<b>Chapter 10</b>	<b>Getting Connected</b>	<b>103</b>
10.1	Comm Manager .....	104
10.2	Connecting to the Internet.....	104
10.3	Internet Explorer® Mobile .....	106

10.4 Bluetooth.....	108
10.5 Using Your XV6900 As a Modem (BroadbandAccess Connect) .....	111
<b>Chapter 11 Experiencing Multimedia</b>	<b>119</b>
11.1 Camera.....	120
11.2 Camera Album.....	126
11.3 Pictures & Videos.....	128
11.4 Windows Media® Player Mobile .....	130
<b>Chapter 12 Managing Your XV6900</b>	<b>135</b>
12.1 Adding and Removing Programs.....	136
12.2 Using Task Manager .....	136
12.3 Resetting Your XV6900 .....	137
12.4 Managing Memory .....	139
12.5 Windows Update .....	139
12.6 Battery Saving Tips .....	140
<b>Chapter 13 Using Other Applications</b>	<b>141</b>
13.1 Voice Speed Dial.....	142
<b>Appendix</b>	<b>145</b>
A.1 Specifications.....	146
A.2 Regulatory Notices .....	148
A.3 Additional Safety Information.....	152
<b>Index</b>	<b>157</b>



# Chapter 1

## Getting Started

**1.1 Getting to Know Your XV6900  
and Accessories**

**1.2 The Battery and the Storage Card**

**1.3 Starting Up**

**1.4 The Today Screen**

**1.5 TouchFLO™**

**1.6 Programs**

**1.7 Settings**

# 1.1 Getting to Know Your XV6900 and Accessories

## Front panel

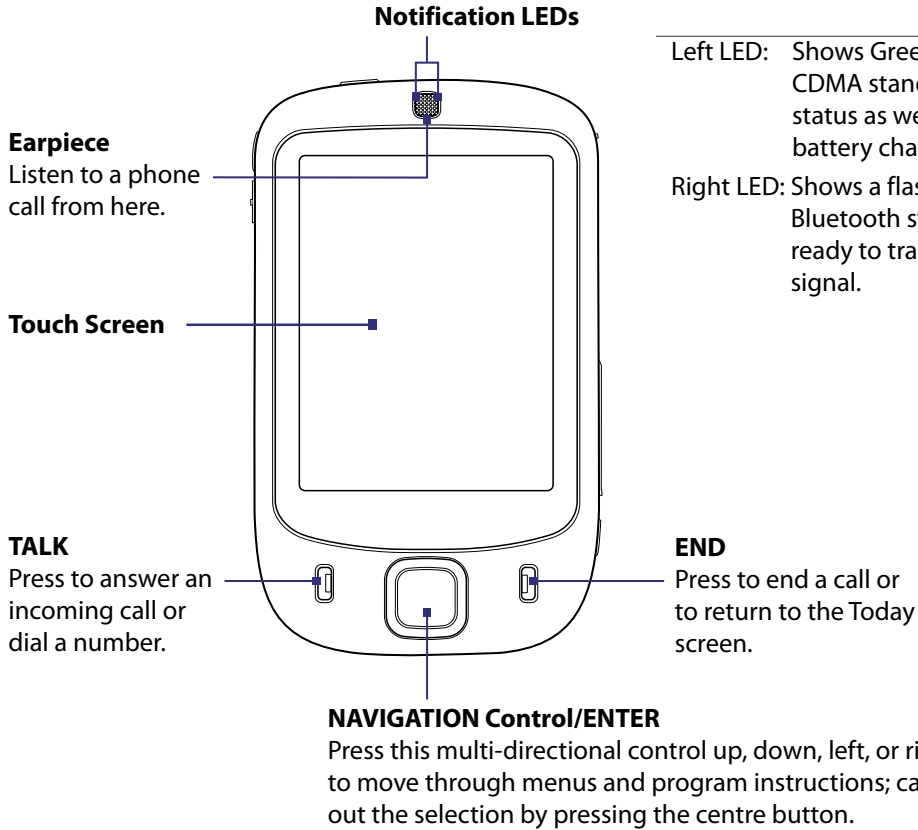

Left LED: Shows Green and Amber lights for CDMA standby, message, and network status as well as for notification and battery charging status.

Right LED: Shows a flashing Blue light when the Bluetooth system is powered up and ready to transmit Bluetooth radio signal.

## Back panel

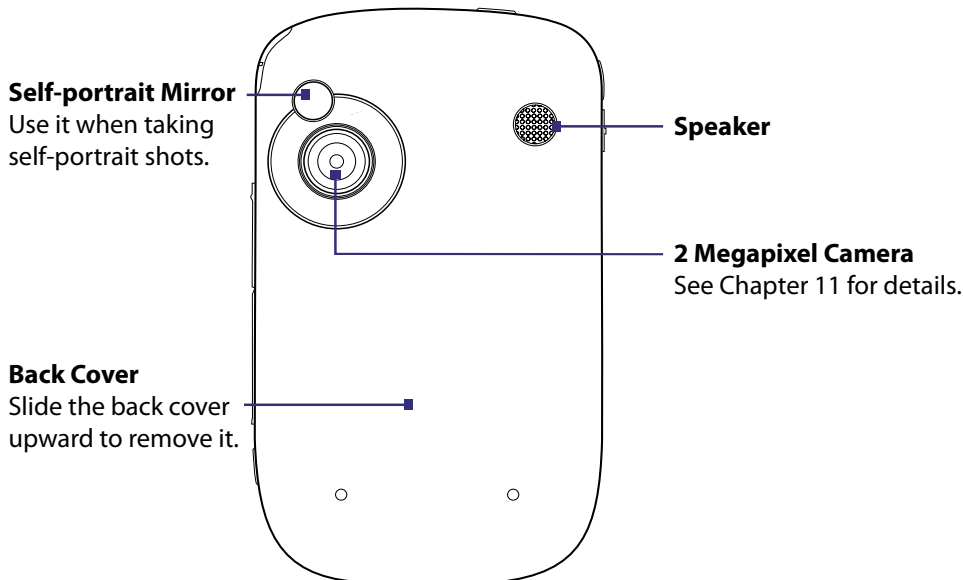

## Top panel

### POWER

Press to turn off the display temporarily.  
To turn off the power, press and hold for about 5 seconds. For more information, see “Starting Up” in this chapter.

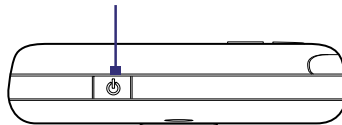

## Left panel

### Volume Slider

- Slide up or down to adjust the speaker volume.
- During a call, slide up or down to adjust the earpiece volume.

### Lanyard/ Strap holder

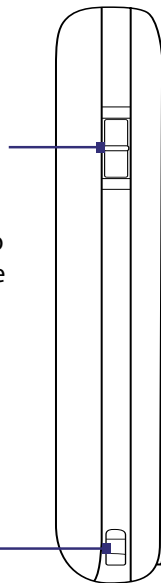

## Right panel

### Stylus

### Storage Card Slot Cover

Remove the back cover and then pry open the slot cover to install the microSD card (not included) for storing data.

### CAMERA

Press to launch the Camera.  
See Chapter 11 for details.

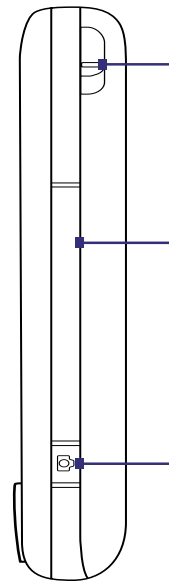

## Bottom panel

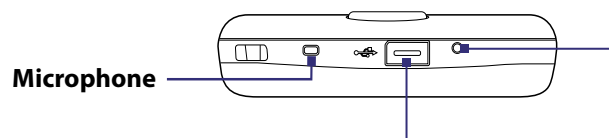

### RESET

With the stylus, press the RESET button to soft-reset your XV6900.

### Sync Connector/Earphone Jack

Connect the supplied USB cable to synchronize information or plug in the AC adapter to recharge the battery. You can also connect a USB stereo headset (sold separately) for hands-free conversation or for listening to audio media.

## Accessories

1

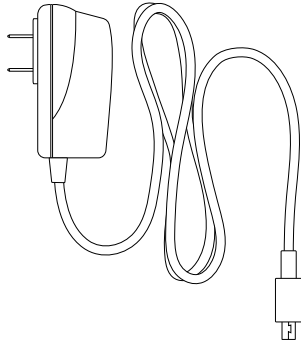

2

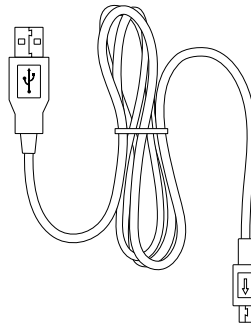

3

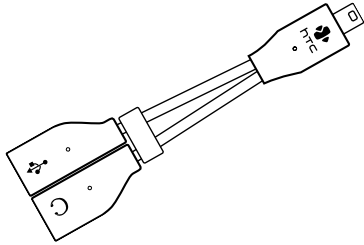

4

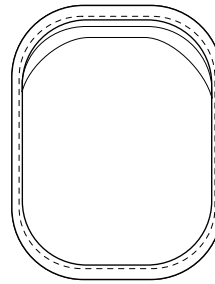

5

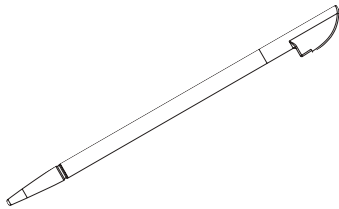

No.	Accessory	Function
1	<b>AC adapter</b>	Recharges the battery.
2	<b>Mini USB Cable</b>	Connects your XV6900 to a PC and synchronizes data.
3	<b>USB Splitter Cable</b>	Lets you connect the supplied power adapter and your stereo headset to the device. This allows you to charge the battery on your XV6900 or synchronize the device with your PC, and at the same time, listen to audio media.
4	<b>Pouch</b>	Acts as a protective carrying case for your XV6900.
5	<b>Stylus</b>	An extra stylus pen is provided.



## The USB Splitter Cable

Use the supplied USB Splitter Cable when you want to charge the battery on your XV6900, and at the same time, use a standard 2.5mm stereo headset (sold separately) for hands-free conversation or for listening to music.

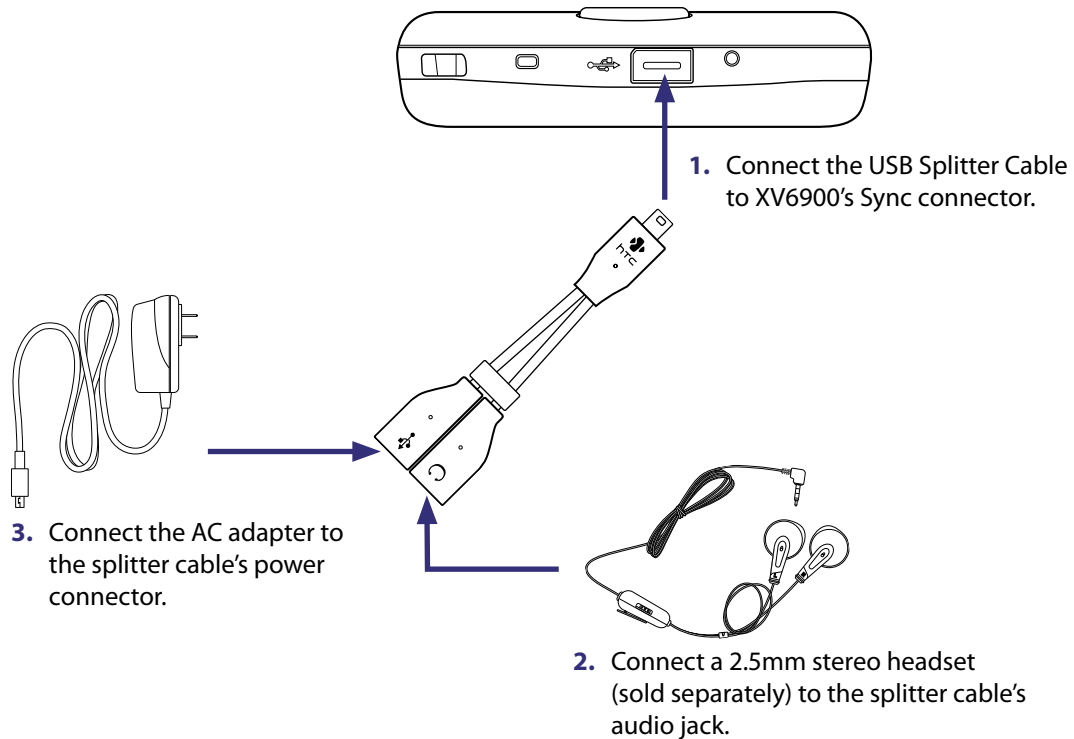

## 1.2 The Battery and the Storage Card

Your XV6900 contains a rechargeable Li-ion battery. It is designed to use only manufacturer-specified original batteries and accessories. Battery performance depends on many factors, including network configuration, signal strength, the temperature of the environment in which you operate your XV6900, the features and/or settings you select and use, items attached to connecting ports, and your voice, data, and other program usage patterns.

Battery life estimates (approximations):

- Standby time: Up to **250** hours.
- Talk time: Up to **3.5** hours.
- Media playback time: Up to **8** hours for WMV; up to **12** hours for WMA.

**Warning!** To reduce risk of fire or burns:

- Do not attempt to open, disassemble, or service the battery pack.
- Do not crush, puncture, short external contacts, or dispose of in fire or water.
- Do not expose to temperatures above 60°C (140°F).
- Replace only with the battery pack designated for this product.
- Recycle or dispose of used battery as stipulated by local regulation.

## Install the battery

### To remove the back cover

Before installing the battery or storage card, you have to remove the back cover.

1. Make sure your XV6900 is turned off.
2. Slide the back cover upward.

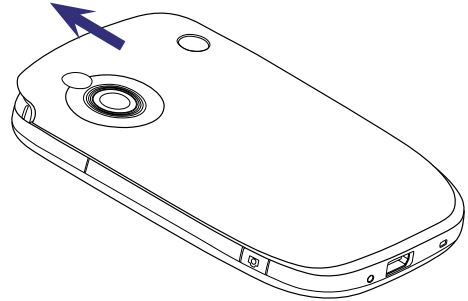

### To install the battery

1. Install the battery by inserting it with its exposed copper part aligned with the protruding copper conductor on the upper right side of the battery compartment. Insert the right side of the battery first, then gently push the battery into place.
2. Replace the back cover.

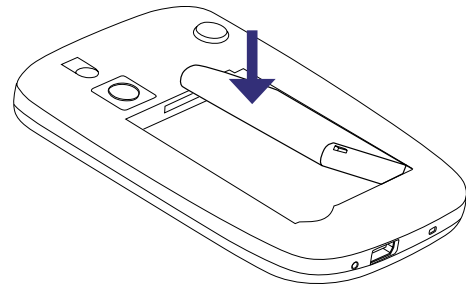

### To remove the battery

1. Make sure your XV6900 is turned off.
2. Remove the back cover.
3. To remove the battery, lift it up from the lower-left end of the battery.

## Battery Information

### To charge the battery

New batteries are shipped partially charged. Before you start using your XV6900, it is recommended that you charge the battery. Some batteries perform best after several full charge/discharge cycles. You can charge the battery in two ways:

- Charging the device's battery by connecting the power adapter.
- Connecting your XV6900 to a PC via the provided Mini USB cable.

**Note** Only the AC adapter and USB cable provided with your XV6900 should be used to charge the device.

Charging is indicated by a solid amber light on the left LED indicator. As the battery is being charged while the device's power is on, a charging icon (🔋) will be shown on the title bar of the Today screen. After the battery has been fully charged, the left LED becomes green and a full battery icon (🔋) appears on the Today screen's title bar.

- Warning!**
- Do not remove the battery from the device while you are charging it using the AC or car adapter.
  - As a safety precaution, the battery stops charging when it overheats.

## To check the battery power

1. Power on your XV6900.
2. Do one of the following:
  - Tap the **Battery** icon (  ) on the title bar of the Today screen.
  - Alternatively, tap **Start > Settings > Systems tab > Power**.

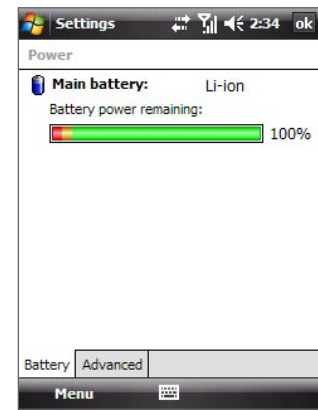

## Low battery

When the low-battery warning appears, do the following:

- Immediately save your current data.
- Synchronize with your PC or connect the power adapter to charge the battery.
- Turn off your XV6900.

## Install the microSD card (not included)

1. Remove the back cover.
2. Use your thumb or finger to pry open the cover that houses the storage card slot. To open the slot cover easier, pry it open from both ends.
3. Flip your XV6900 so that the touch screen faces upward.
4. Hold open the slot cover with one hand.

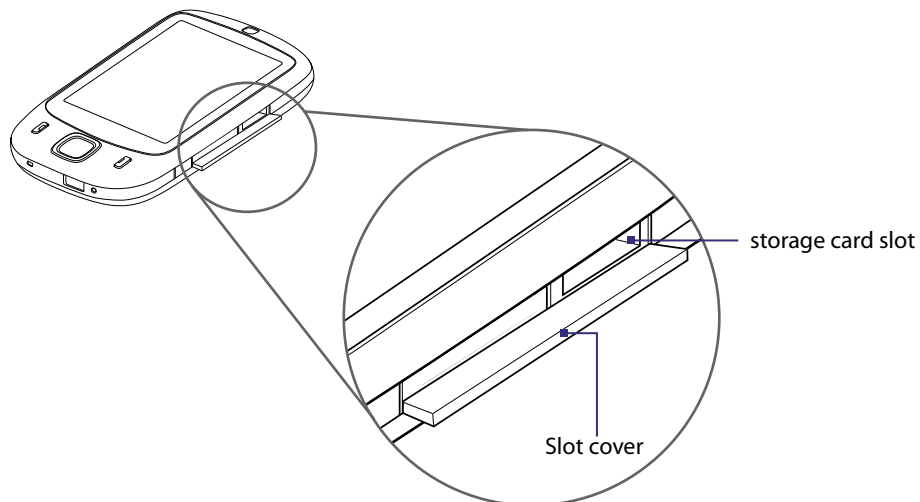

5. Insert the microSD card into the storage card slot with the gold contacts facing down.
6. Close the slot cover.
7. Replace the back cover.

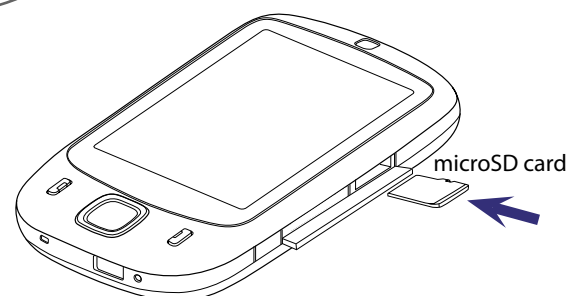

**Note** To remove the storage card, press the card to pop it out of the slot.

## 1.3 Starting Up

After inserting the battery, you can now power on and start using your XV6900.

### Turn your XV6900 on and off

#### To turn on the power

- Press the POWER button. When you turn on your XV6900 for the first time, a Quick Start Wizard will guide you through the calibration process and the setup of regional settings, date and time, and password. For more information about touch screen calibration, see “Calibrate the device”.

#### To turn off the power

- Press and hold the POWER button for a few seconds. A message will then be displayed, prompting you whether or not to turn off the device completely.

### Calibrate the device

Calibrating the touch screen involves tapping the centre of a cross with the stylus as the cross moves around the screen. This process ensures that when you tap the screen with your stylus, the tapped item is activated. If your XV6900 does not accurately respond to screen taps, follow these steps to re-calibrate it:

1. Tap **Start > Settings > System tab > Screen**.
2. On the **General** tab, tap **Align Screen**, then follow the on-screen instructions to complete the calibration.

### Manage screen settings

The device’s display has the following orientation modes: **Portrait** and **Landscape**. To change the orientation, tap **Start > Settings > System tab > Screen**, and select the orientation you want.

- To smooth the edges of screen fonts for many programs, on the **ClearType** tab, select the **Enable ClearType** check box.
- To increase the readability or to see more content on the screen, on the **Text Size** tab, adjust the text size by moving the slider.

**Tip** To quickly change the screen orientation, you can also tap the **Rotate Screen** icon in HTC Home’s Launcher. See “HTC Home” later in this chapter for details.

### Switch your XV6900 to Sleep mode

Quickly pressing the POWER button turns off the display temporarily and switches your XV6900 to **Sleep mode**. Sleep mode suspends your XV6900 to a low power state while the display is off in order to save battery power. Your XV6900 also automatically goes into Sleep mode when you leave the device idle after a certain amount of time.

You will still be able to receive messages and calls while your XV6900 is in Sleep mode. Pressing the POWER button again or new incoming calls/messages will wake up your XV6900.

#### To specify the timeout period before your XV6900 goes into Sleep mode

1. Tap **Start > Settings > System tab > Power > Advanced** tab.
2. Under **On battery power**, make sure the **Turn off device if not used for** check box is selected.
3. Select the battery timeout period, then tap **OK**.

## 1.4 The Today Screen

The Today screen displays important information, such as upcoming appointments and status indicators. You can tap a section on the screen to open the associated program.

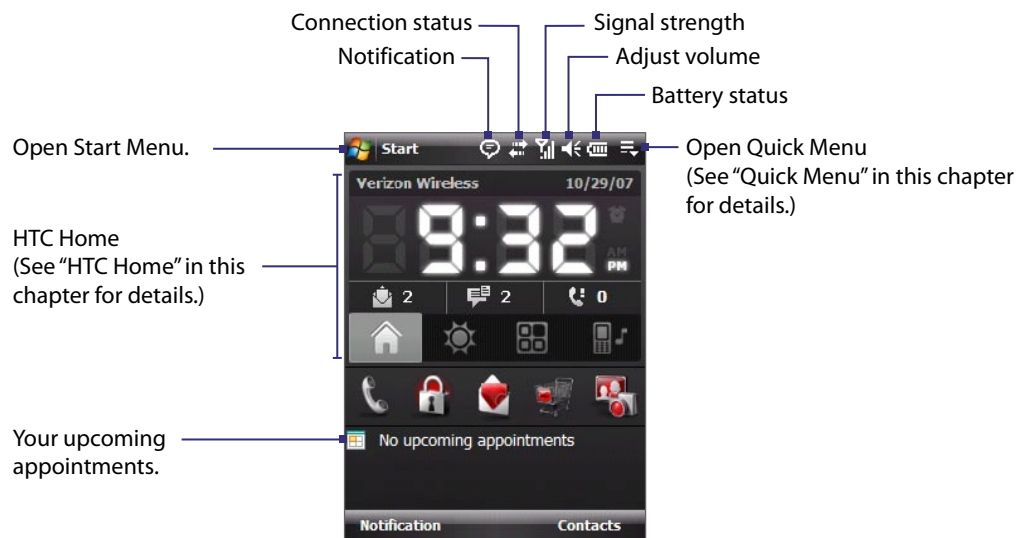

- To access the Today screen, tap **Start > Today**.
- To customize the Today screen display, including the background image, tap **Start > Settings > Personal tab > Today**.

For more information about customizing the Today screen, see Chapter 4.

## Status Icons

The following are some of the status icons that you may see on the device.

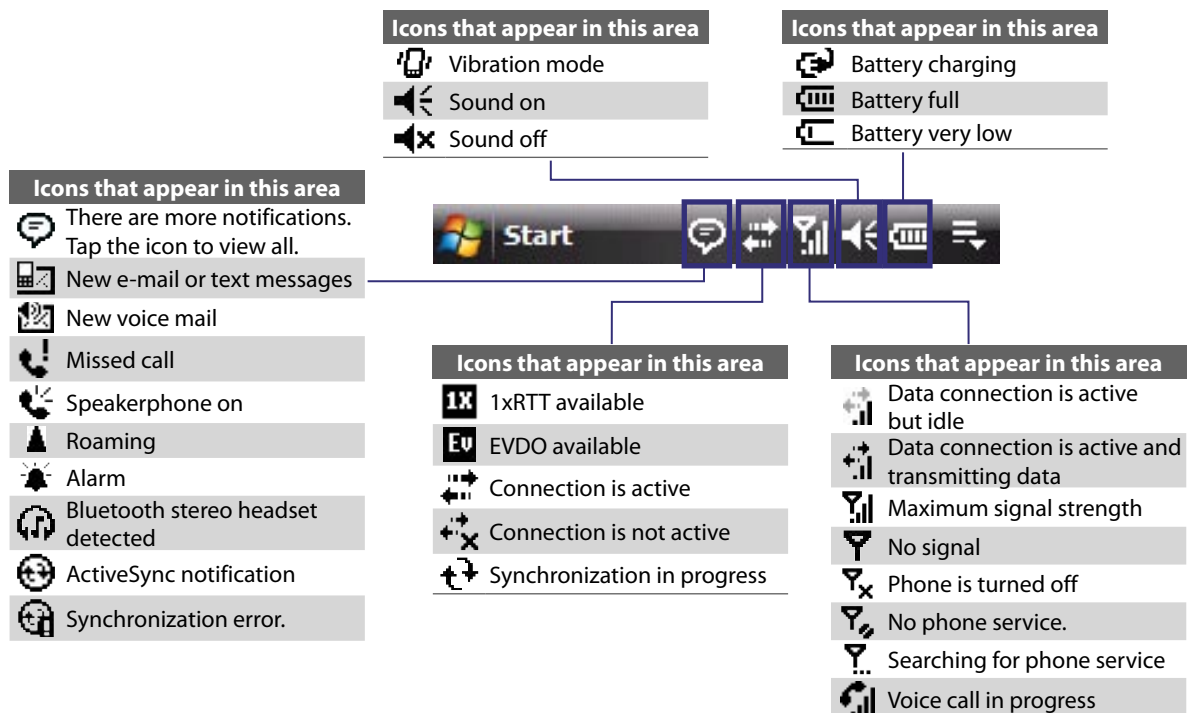

## The Start Menu

The Start menu, located at the top left corner of the Today screen, displays a list of programs. You can start a program by scrolling through the programs list and then pressing ENTER, or by tapping a program with the stylus.

- Open a recently-used program.
- Switch to the Today screen.
- Open a program. (The items displayed in the Start menu can be customized by tapping **Start > Settings > Personal tab > Menus.**)
- Access more programs.
- View and change settings.
- View Help information for the current screen.

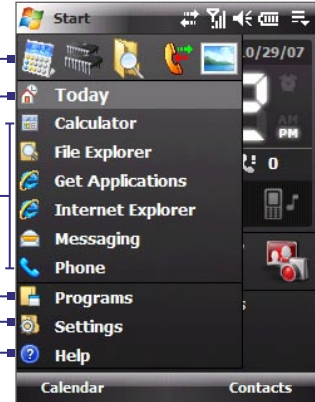

## Quick Menu

The Quick Menu, located at the top right corner of the Today screen, shows the currently running programs. You can quickly switch between running programs and stop programs when you do not need to use them.

- Stop all currently running programs.
- Customize Task Manager settings. (See "Using Task Manager" in Chapter 12.)
- Tap this button to open the Quick Menu.
- Display the percentage of memory in use. Tap this icon to view more information about memory usage.
- To switch to a running program, tap the program name.
- To stop running a program, tap .

## HTC Home

**HTC Home** is a Today screen plug-in that gives you up-to-date local information at a glance, such as time, day and weather information, and shows new messages and missed calls. It also has a customizable launcher where you can add your favorite applications for one-touch access.

HTC Home has four components: **Home**, **Weather**, **Launcher**, and **Sound**. At the bottom of HTC Home, there is a toolbar that allows you to switch between these components.



### To switch between the different components of HTC Home

Do any of the following:

- Touch the tabs in the toolbar using your finger.
- Tap the tabs in the toolbar using the stylus.
- Use the NAVIGATION Control. If the toolbar is not selected, press NAVIGATION up/down first to select the toolbar. Press NAVIGATION left/right to select a tab and then press ENTER.

## The Home tab

**Home** displays the current day, date and local time. When you have new incoming messages and calls, it shows you the number of new e-mails, text messages, and missed calls. If you have set up the alarm, it also shows the Alarm icon.



## The Weather tab

**Weather** shows you the current weather as well as weather information of the next four days of the week. The first time you use this feature, you need to select your city first to get the weather information of your city.

1. Select the **Weather** tab (  ).
2. Touch the area that shows **Select your city here**.
3. On the Select City screen, browse through the list of cities and choose your city.
4. Tap **Select**.

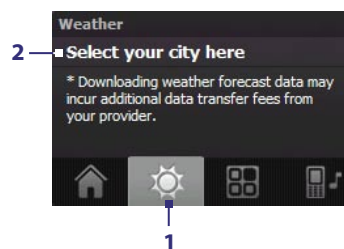

After selecting your city, your XV6900 automatically connects to the Internet via the data connection and downloads weather information of the current day and the next four days of the week. The current temperature, the highest and lowest temperatures, and a visual indicator of the climate (showing if it's a cloudy or rainy day, etc.) will be displayed in the **Weather** tab.

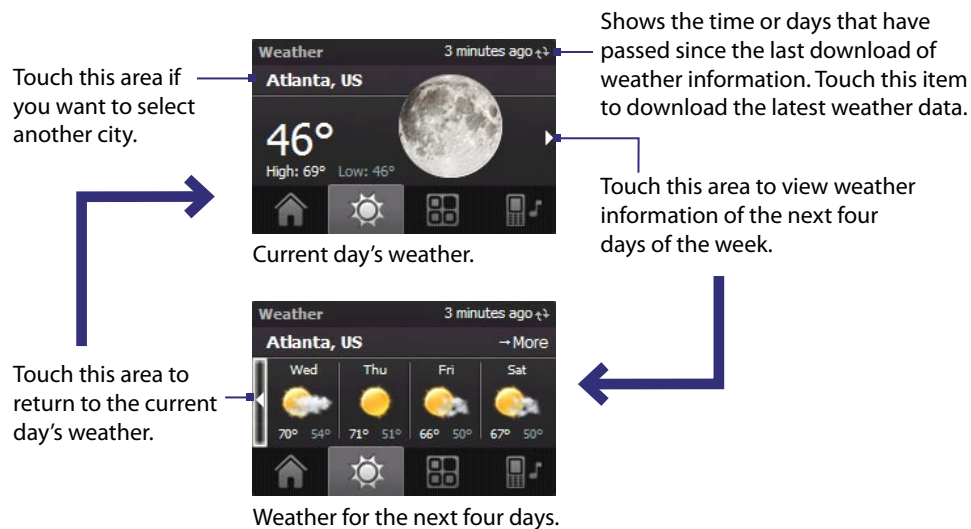



**Note** If you have not connected to the Internet and downloaded weather information for five days, the following error message will be displayed: "Unable to retrieve data for selected city. Select here to retry." Use the data connection to connect your XV6900 to the Internet, then touch the area that shows the error message to download weather data.

You can also customize weather settings through the following steps:

1. Touch the area that shows the city name.
2. On the Select City screen, select **Menu > Weather Options**.
3. You can enable or disable the following options:

- **Download weather data automatically.** When this check box is selected, weather information will automatically be downloaded from the AccuWeather Web site whenever you select the **Weather** tab, if the data has not been updated within the last three hours. Weather data will also be downloaded every time an ActiveSync connection occurs (through over-the-air or USB connection).

Clear this check box if you prefer to manually download weather information.

- **Download when roaming.** Select this check box only if you want to allow automatic download of weather data when you're roaming. This may incur additional costs.

- **Temperature Scale.** Choose whether to display temperature in Celsius or Fahrenheit.

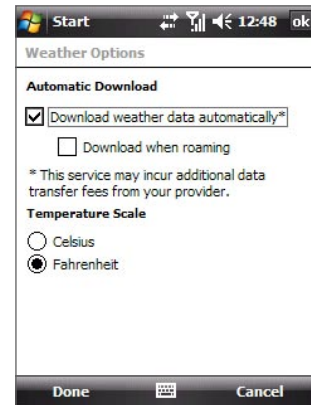

**Tip** To check for more detailed weather information on the AccuWeather Web site, select **Menu > About Weather** on the Select City screen and then touch the link that shows AccuWeather.com. Internet Explorer Mobile then opens and brings you to the AccuWeather Web site.

### The Launcher tab

**Launcher** allows you to add quick shortcuts to your favorite programs and settings for one-touch access. Quick settings such as **Adjust Backlight**, **Rotate Screen** and **Lock Device**, and a few program shortcuts are added by default. They can be replaced with your preferred settings and programs.

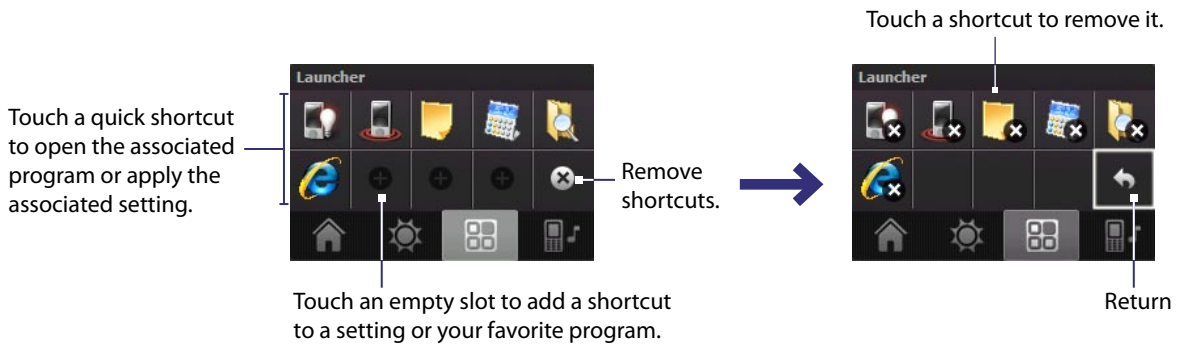

**Note** To replace a shortcut, you need to delete it first and then add a shortcut to your favorite program or setting.



## The Sound tab

**Sound** lets you quickly set the device volume and change the ring tone of your XV6900.

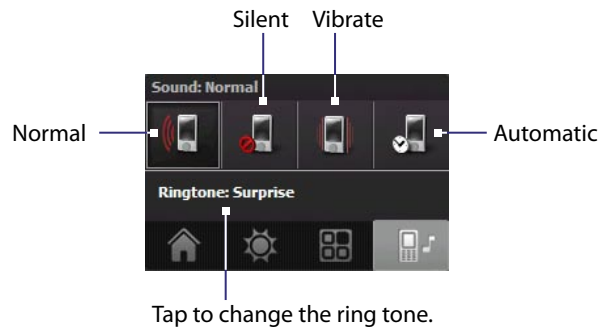

- Tap the sound mode icon to set the device to **Normal**, **Silent**, **Vibrate**, or **Automatic** mode.
- Touch the **Ringtone** area to open the phone sound settings to change the ring tone.

**Note** Tap the **Automatic** icon to set the device volume to Automatic mode. If Automatic is selected, the device will vibrate during a scheduled event in your calendar; when there is no scheduled event in your calendar, the device will use the Normal mode setting.

## 1.5 TouchFLO™

**TouchFLO™** is a special feature that gives you better touch panel experience on your XV6900. With TouchFLO, you can simply use your finger to scroll and pan the screen.

TouchFLO also features **Touch Cube** where you can launch messaging programs, Internet Explorer® Mobile, and more. You can also add your favorite contacts, play music, and access your pictures and videos.

**Note** Touch Cube is displayed in portrait view only. To be able to open Touch Cube, make sure your display is set to portrait mode.

### Touch Cube

#### To open Touch Cube

- Slide your finger upward, starting from the logo at the bottom of the touch screen.



#### To close Touch Cube

- To close Touch Cube and return to the screen prior to opening Touch Cube, slide your finger downward on the touch screen.



### To navigate Touch Cube

Touch Cube is a three-dimensional, cubic user interface. To flip the interface from one side to another, slide your finger left or right on the touch screen.

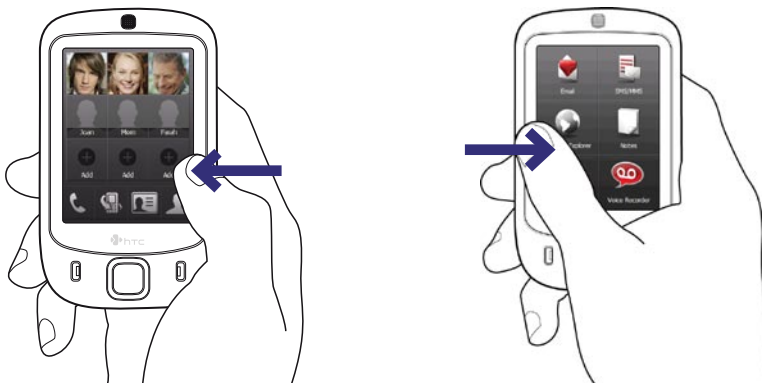

### Touch Cube screens

There are three sides to the Touch Cube interface:

- On the first side of the interface, you can add up to nine favorite contacts. If you make calls to certain people frequently, you can add them as favorite contacts for quicker access.

**Note** You should already have contacts created or synchronized on your XV6900 before you can add them as favorite contacts.

For more information about creating contacts, see Chapter 6.

For more information about synchronizing your XV6900 with the PC, see Chapter 5. For information about synchronizing your XV6900 with the Exchange Server, see Chapter 8.

• Tap to call the number associated with the contact.

• Tap and hold to open the contact card.

Select an empty slot to add a favorite contact.

Open the Phone program. (See Chapter 3 for details.)

Open Call History. (See Chapter 3 for details.)

When you add a favorite contact and there is no photo associated to that contact, the contact's first name (or last name) will be displayed.

Delete favorite contacts.

Open Contacts. (See Chapter 6 for details)

Select a favorite contact to remove it.

Return to your list of favorite contacts.

**Note** When you have different phone numbers assigned to the same contact, an icon appears on the top left corner of the contact square to tell you which number is assigned to the particular square: mobile phone (📱), work phone (🏢), or home phone (🏠).

- The second side of the interface provides quick shortcuts to your e-mail messages, text messages, the Internet, and other applications.

Simply touch the icons on the screen to open the corresponding program.



- On the third side of the interface, you can play back music and access the images and video files on your XV6900.

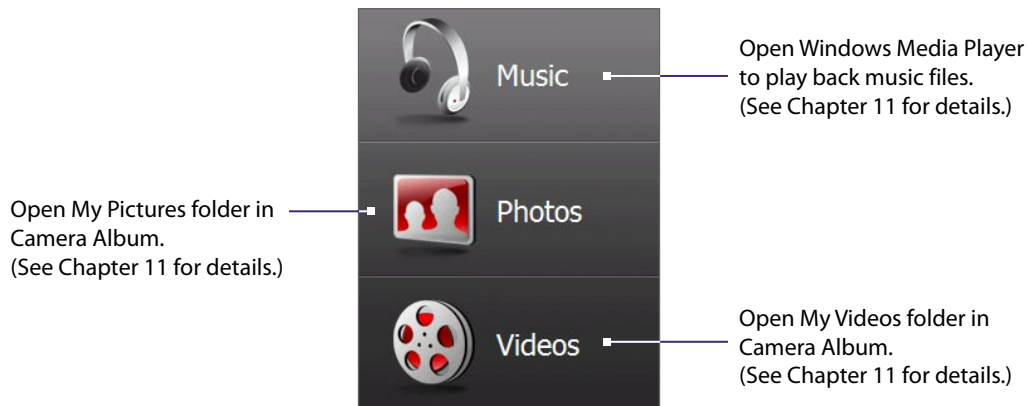

## Finger scrolling and finger panning

With TouchFLO, you can use finger scrolling and finger panning when viewing content that cannot entirely fit on the screen, such as Web pages, documents, and messages. Finger scrolling can also be used to scroll up and down lists such as the contacts list, file list, message list, calendar appointments list, and more.

**Note** Finger scrolling and panning works in both portrait and landscape modes.

### To use finger scrolling

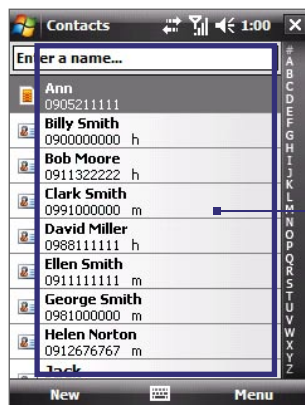

When finger scrolling up and down, slide anywhere within this area.

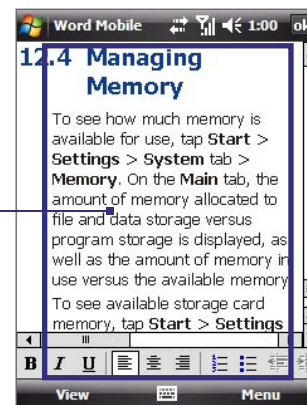

- Slide your finger downward to scroll up the screen.
- Slide your finger upward to scroll down the screen.
- To scroll towards the left, slide your finger to the right.
- To scroll towards the right, slide your finger to the left.
- While the screen is scrolling, you can stop the scrolling by pressing your finger on the touch screen.

**Note** Scrollbars shown on the screen indicate that there are more content that cannot entirely fit on the screen. You can finger-scroll up and down only when there's a vertical scrollbar shown on the screen. Likewise, you can finger-scroll left and right only when there's a horizontal scrollbar.

### To use finger panning

- To pan downward, touch and hold on the touch screen then drag your finger upward.
- To pan upward, touch and hold on the touch screen then drag your finger downward.
- To pan towards the right, touch and hold on the touch screen then drag your finger to the left.
- To pan towards the left, touch and hold on the touch screen then drag your finger to the right.
- You can also pan diagonally.

**Note** Scrollbars shown on the screen indicate that there are more content that cannot entirely fit on the screen. You can use finger panning only when there are scrollbars shown on the screen.

### To continuously pan

1. Drag your finger towards the boundary and hold. The Web page, document, or message that you are viewing then continuously pans.

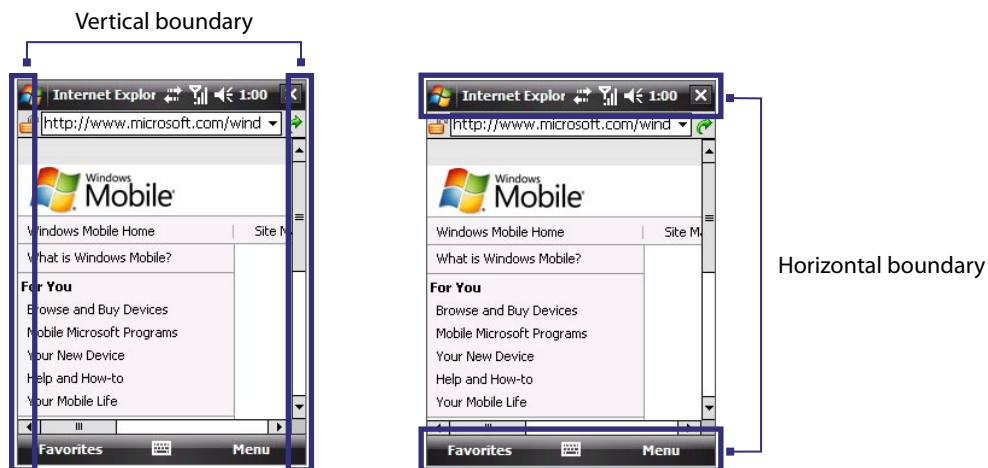

2. Release your finger to stop panning.

## Enhanced features

TouchFLO provides enhanced features when you use E-mail and Contacts applications on the device.

### To navigate to the previous or next e-mail message in Outlook

When you open Outlook to check your appointments or e-mail messages, TouchFLO enables you to navigate through the information easily by sliding your finger left or right on the touch screen.

- Slide your finger to the right to navigate to the previous e-mail message.
- Slide your finger to the left to navigate to the next e-mail message.

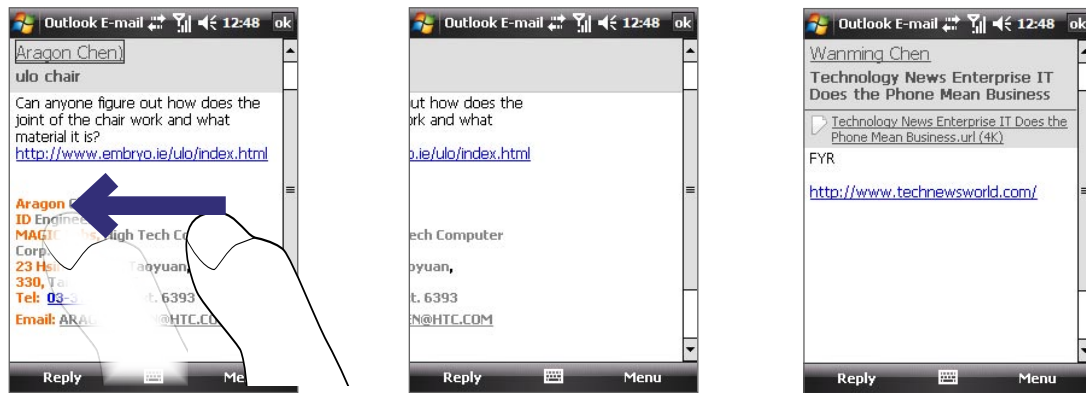

**Tip** If you slide to the right and you are on the first e-mail message, or slide to the left and you are on the last e-mail message, you will be returned to the e-mail list screen.

### To random access in Contacts

When you open the Contacts list, the Random Access bar allows you to quickly scroll through the list.

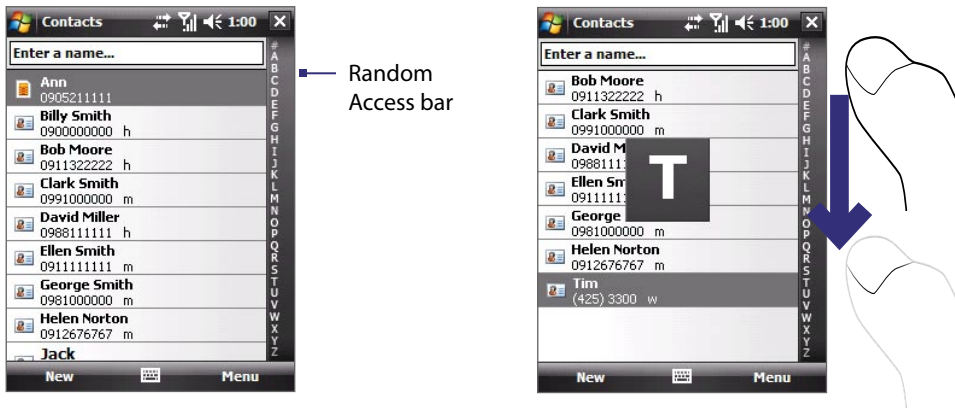

On the Random Access bar, tap a letter or scroll to a letter to contacts beginning with that letter.

### TouchFLO settings



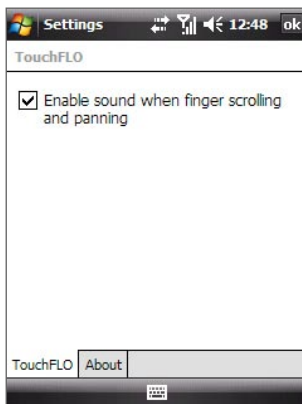



You can enable or mute the finger scrolling and panning sound. Tap **Start > Settings > System tab > TouchFLO** then select or clear the **Enable sound when finger scrolling and panning** check box.

















## 1.6 Programs











The following are programs that are preinstalled on your XV6900.

### Programs in the Start Menu

Icon	Description
	<b>Calculator</b> Perform basic arithmetic and calculations, such as addition, subtraction, multiplication, and division.
	<b>File Explorer</b> Organize and manage files on your XV6900.
	<b>Get Applications</b> Link you to a Web site where you can purchase and download programs that you can install on your XV6900.
	<b>Internet Explorer Mobile</b> Browse Web and WAP sites as well as download new programs and files from the Internet.
	<b>Messaging</b> Send and receive e-mail, MMS, and text messages.
	<b>Phone</b> Make and receive calls, switch between calls, and set up conference calling.
	<b>Help</b> See Help topics for the current screen or program.

### Programs screen











Icon	Description
	<b>Games</b> Play two pre-installed games: <b>Bubble Breaker</b> and <b>Solitaire</b> .
	<b>Office Mobile</b> Use the complete suite of Microsoft® Office applications for your mobile device.
	<b>Excel Mobile</b> Create new workbooks or view and edit Microsoft® Office Excel® workbooks.
	<b>PowerPoint Mobile</b> View Microsoft® Office PowerPoint® slides and presentations.
	<b>Word Mobile</b> Create, view, and edit Microsoft® Office Word documents.
	<b>ActiveSync</b> Synchronize information between your XV6900 and a PC or the Exchange Server.
	<b>Adobe Reader LE</b> View PDF (Portable Document Format) files on your XV6900.
	<b>Bluetooth Explorer</b> Search for other Bluetooth devices that have file sharing enabled and access their Bluetooth shared folder.
	<b>Calendar</b> Keep track of your appointments and create meeting requests.
	<b>Camera</b> Take photos or shoots video clips with accompanying audio.
	<b>Camera Album</b> View your photos and videos.
	<b>Comm Manager</b> Manage your XV6900's connections (including Bluetooth and ActiveSync), turn the phone on or off, switch to ringer/vibration mode, enable or disable the Direct Push function, and more.
	<b>Contacts</b> Keep track of your friends and colleagues.
	<b>Modem Link</b> Activate your XV6900 as a modem for your notebook computer.
	<b>Notes</b> Create handwritten or typed notes, drawings, and voice recordings.

Icon	Description
	<b>Pictures &amp; Videos</b> View, organize, and sort pictures, animated GIFs (Graphics Interchange Format), and video files on your XV6900 or a storage card.
	<b>Running Programs</b> Allow you to check which programs are currently running and stop running programs to free up memory space.
	<b>Search</b> Search contacts, data, and other information on your XV6900.
	<b>Tasks</b> Keep track of your tasks.
	<b>Text Messages Retry</b> Resend SMS messages that failed delivery.
	<b>Voice Recorder</b> Record your voice, play it back, then send it via e-mail or Bluetooth. You can also set the recorded voice as your ring tone.
	<b>Voice Speed Dial</b> Record voice tags so that you can dial a phone number or launch programs simply by speaking a word.
	<b>Voice Speed Dial Switch</b> Enable or disable Voice Speed Dial on your XV6900.
	<b>Windows Media Player Mobile</b> Play back audio and video files.
	<b>Wireless Sync</b> This software from Verizon Wireless allows you to synchronize and view e-mails, and access information such as as calendar appointments, contacts, tasks, etc. that are stored on your XV6900.
	<b>ZIP</b> Save memory and free up storage space on your XV6900 by compressing files in the conventional ZIP format.

## 1.7 Settings



















You can adjust the device settings to suit the way you work. To see all available settings, tap **Start > Settings**, then tap the **Personal**, **System**, and **Connections** tabs located at the bottom of the screen.

### Personal tab

Icon	Description
	<b>Buttons</b> Assign a program or function to the hardware button.
	<b>Input</b> Set options for each of the input methods.
	<b>Large Start Menu</b> Enlarge the Start menu to make it easier to touch menu items with your fingers.
	<b>Lock</b> Set a password for your XV6900.
	<b>Menus</b> Set what programs will appear in the Start menu.
	<b>Owner Information</b> Enter your personal information on your XV6900.
	<b>Phone</b> Customize phone settings such as ring tone, and more.
	<b>Sounds &amp; Notifications</b> Enable sounds for events, notifications, and more, and set the type of notification for different events.
	<b>Today</b> Customize the appearance and the information to be displayed on the Today screen.
	<b>Voice Speed Dial</b> Create voice tags for voice dialing contacts as well as for launching programs.









## System tab

Icon	Description
	<b>About</b> This is where you can see basic information such as the Windows Mobile version and type of processor used on your XV6900. You can also specify a name for your XV6900.
	<b>Backlight</b> Set the backlight timeout and adjust brightness.
	<b>Certificates</b> See information about certificates that are installed on your XV6900.
	<b>Clear Storage</b> Tap this icon only when you need to remove all your data and files from the memory and reset your XV6900 to factory default settings.
	<b>Clock &amp; Alarms</b> Set the device clock to the date and time of your locale or to a visiting time zone when you're travelling. Alarms can also be set at specified days and times of a week.
	<b>Customer Feedback</b> Send feedback to the Customer Experience Improvement Program of Microsoft.
	<b>Device Information</b> See information about the firmware version, hardware, identity, and the duration of calls made on your XV6900.
	<b>Encryption</b> Allow files on your storage card to be encrypted. Encrypted files will be readable only on your XV6900.
	<b>Error Reporting</b> Enable or disable the device's error reporting function. When this function is enabled and a program error occurs, technical data about the state of the program and your computer will be logged in a text file and delivered to Microsoft's technical support if you choose to send it.
	<b>External GPS</b> Set the appropriate GPS communication ports, if required. You may need to do this when there are programs on your XV6900 that access GPS data or you have connected a GPS receiver to your XV6900. See Help for details.
	<b>Key Lock</b> Lock the buttons on your XV6900 except for the POWER button when the device is in Sleep mode. This ensures you will not switch the device on by accident and consume unnecessary power.
	<b>Long Press End Key</b> Set the behavior of the END key when it is held down.
	<b>Memory</b> Check the device memory allocation status and memory card information. You can also stop currently running programs.
	<b>Power</b> Check the remaining battery power. You can also set the timeout for turning off the display (switching device to Sleep mode) to conserve battery power.
	<b>Regional Settings</b> Set the regional configuration to use, including the format for displaying numbers, currency, date, and time on your XV6900.
	<b>Remove Programs</b> Remove programs that you installed on your XV6900.
	<b>Screen</b> Change the screen orientation, re-calibrate the screen, and change the screen text size.
	<b>Task Manager</b> Stop running programs and set the <b>Exit</b> button (  ) to end programs immediately when you tap the button. For more information, see "Using Task Manager" in Chapter 12.
	<b>TouchFLO</b> You can enable or mute the finger scrolling and panning sound. See "TouchFLO settings" in this chapter for details.
	<b>Windows Update</b> Update Windows Mobile® on your XV6900 with security patches or fixes, if they are available.



## Connections tab

Icon	Description
	<b>Beam</b> Set your XV6900 to receive incoming Bluetooth beams.
	<b>Bluetooth</b> Turn Bluetooth on, set your XV6900 to visible mode, and scan for other Bluetooth devices.
	<b>Comm Manager</b> Manage your XV6900's connections (including Bluetooth and ActiveSync), turn the phone on or off, switch to ringer/vibration mode, enable or disable the Direct Push function, and more.
	<b>Connections</b> Set up one or more types of modem connections for your XV6900, such as phone dial-up, and more, so that your XV6900 can connect to the Internet or a private local network.
	<b>Network Cards</b> Configure the network adapter of the device.
	<b>USB to PC</b> Set a USB serial connection between your XV6900 and PC when there are problems connecting ActiveSync.



# Chapter 2

## Entering and Searching Information

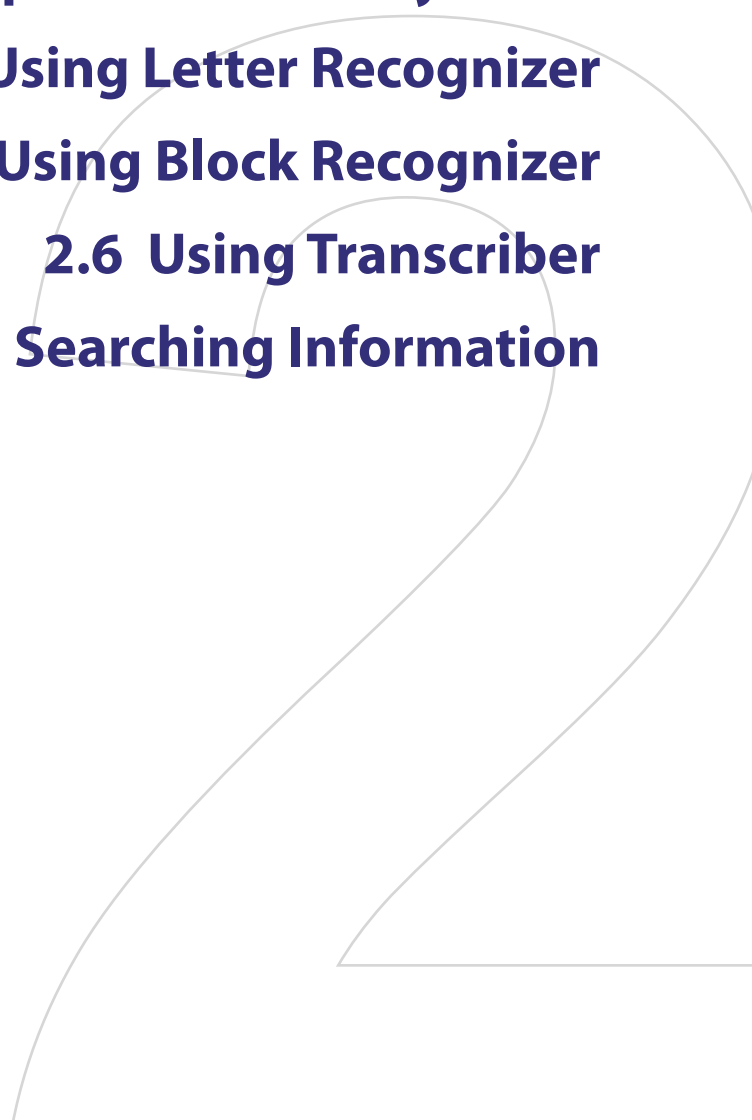
- 2.1 Entering Information**
  - 2.2 Using the On-screen Keyboard**
  - 2.3 Using Touch Keypad or Touch Keyboard**
  - 2.4 Using Letter Recognizer**
  - 2.5 Using Block Recognizer**
  - 2.6 Using Transcriber**
  - 2.7 Searching Information**
- 

## 2.1 Entering Information

When you start a program or select a field that requires text or numbers, the **Input Panel** icon becomes available on the menu bar.

Tap the **Input Selector** arrow (that appears next to the **Input Panel** icon) to open a menu where you can select a text input method and customize input options. After selecting a text input method, the corresponding **Input Panel** is then displayed and you can use it to enter text. To toggle between showing and hiding the Input Panel, simply tap the **Input Panel** icon.

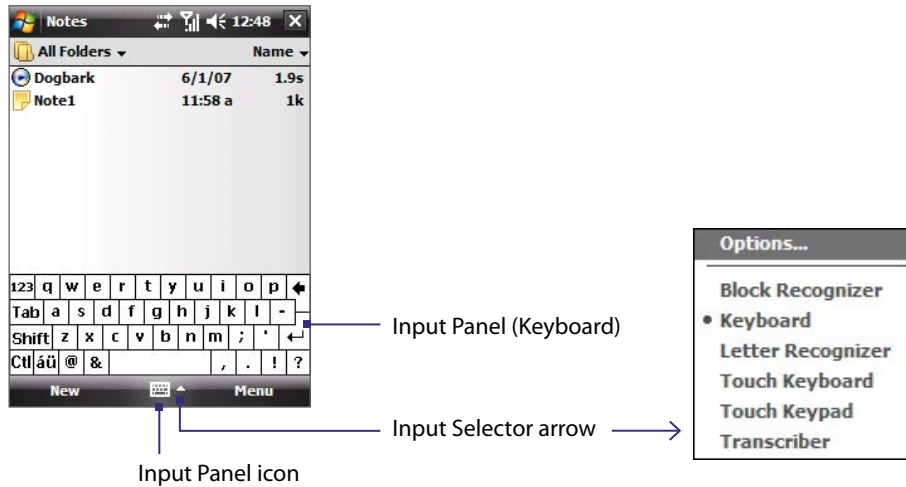

Icon	Input method	Icon	Input method
	On-screen Keyboard		Touch Keyboard
	Letter Recognizer or Block Recognizer		Touch Keypad
	Transcriber		

**Note** Some text input methods may not be available in certain language versions of the device.

## 2.2 Using the On-screen Keyboard

The on-screen **Keyboard** is available when text entry is possible. You can enter text by tapping keys on the keyboard that are displayed on the screen.

### To enter text using the on-screen Keyboard

1. In a program, tap the **Input Selector** arrow, and tap **Keyboard**.
2. Enter text by tapping keys on the on-screen Keyboard.

### To enlarge the on-screen Keyboard

1. Tap the **Input Selector** arrow, then tap **Options**.
2. In the **Input method** list, select **Keyboard**.
3. Tap **Large keys**.

## 2.3 Using Touch Keypad or Touch Keyboard

**Touch Keypad** simulates a wireless phone keypad on the touch screen to allow you to enter text, numbers, and symbols just as if you were using a wireless phone keypad.

**Touch Keyboard** simulates a 20-key QWERTY (typewriter) keyboard on the touch screen to allow you to enter text, numbers, and symbols similar to the way you would using a QWERTY keyboard.

### To use Touch Keypad or Touch Keyboard

- In a program, tap the **Input Selector** arrow, and then tap **Touch Keypad** or **Touch Keyboard**.

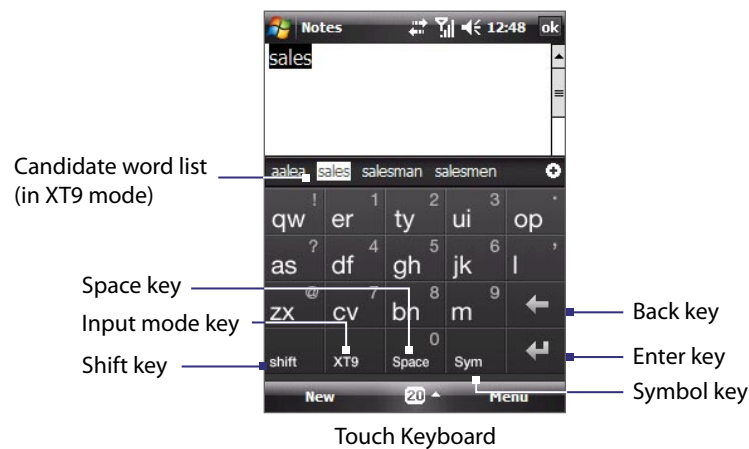
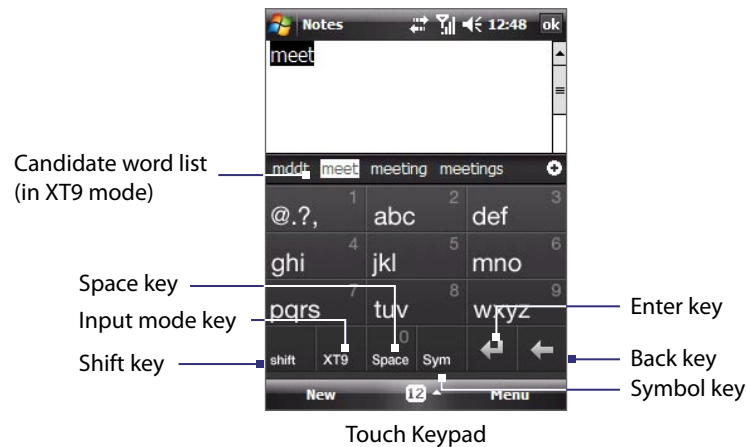

- To type lowercase letters, tap the keys on the keypad or keyboard.
- To type a single uppercase letter, tap the **Shift** key and then tap the corresponding key.
- To type all uppercase letters, tap the **Shift** key twice. To change back to all lowercase letters, tap again.
- To enter a space after the word, tap the **Space** key.
- To start a new line, tap the **Enter** key.
- To backspace and delete a single character in any input mode, tap the **Back** key.
- To open the Symbol pad, tap the **Symbol** key.

### To change the input mode

- Tap the **Input mode** key to switch to a different input mode: **XT9** (predictive), **Multitap** (abc), or **Numeric** (123).

## Use XT9 mode

To enter a word in XT9 mode, press the keys that contain the letters you want. As you enter letters, XT9 analyses your keypresses and attempts to complete the word. If there is more than one choice in the XT9 dictionary for your entry, a list of available words is displayed in the candidate word list (at the top of the keypad or keyboard).

For example, to enter the word “shoe” in Touch Keypad, tap , , , .

## Use Multitap mode

In Multitap mode, you enter a character by pressing the key on which the character appears.

- To enter the first character on the key, tap once. To enter the second character on the key, tap twice, and so on.
- To enter characters that are on the same key, pause after you enter the first character.

## Use Numeric mode

If you need to enter numbers within a line of text, change to numeric mode. While in numeric mode, enter the number you want by tapping the corresponding key on the keypad or keyboard.

## Configure Touch Keypad and Touch Keyboard

1. Do one of the following:
  - Tap the **Input Selector** arrow, and then tap **Options** from the shortcut menu; or
  - Tap **Start > Settings > Personal** tab > **Input**.
2. Select **Touch Keypad** or **Touch Keyboard** in Input method, and then tap **Options**.
  - **Language:** Select your input language. The keyboard layout will change according to your selection.
  - **Turn on one-touch symbol entry:** The default setting for this option is ON, so that you can enter only one symbol at a time (the Symbol pad will be closed after you input a symbol). To enter symbols continuously, clear this option to disable the feature.
  - **XT9 Settings:** Tap to configure advanced XT9 settings, such as turning spelling correction on or off.

## 2.4 Using Letter Recognizer

With **Letter Recognizer**, you can write individual letters, numbers, and punctuation, which are then converted into typed text.

### To use Letter Recognizer

1. From a program, tap the **Input Selector** arrow, and tap **Letter Recognizer**.
2. Write characters, numbers, and symbols in the designated writing area.
  - Enter capital letters by writing in the **ABC** (left) area of the box.
  - Enter lower case letters by writing in the **abc** (middle) area of the box.
  - Enter numbers by writing in the **123** (right) area of the box.
  - Enter punctuation and symbols by tapping in either area of the box and then writing the desired character.

**Note** **Letter Recognizer** is available when text entry is possible.

**Tip** For help with writing characters, tap the question mark near the writing area.

## 2.5 Using Block Recognizer

With **Block Recognizer**, you use a single stroke to write letters, numbers, symbols, and punctuation, which are then converted into typed text.

### To use Block Recognizer

1. From a program, tap the **Input Selector** arrow, and tap **Block Recognizer**.
2. Write characters, numbers, and symbols in the designated writing area.
  - Enter letters by writing in the **abc** (left) area of the box.
  - Enter numbers by writing in the **123** (right) area of the box.
  - Enter symbols and punctuation by tapping in either area of the box and then writing the desired character.

**Note** **Block Recognizer** is available when text entry is possible.

**Tip** For help with writing characters with **Block Recognizer**, tap the question mark near the writing area.

## 2.6 Using Transcriber

**Transcriber** is a handwriting recognition program that allows you to write in cursive, print, or a combination of both.

### To write using Transcriber

1. Start a program that accepts user input, such as Word Mobile.
2. Tap the **Input Selector** arrow, and tap **Transcriber**. The Transcriber introductory screen appears.
3. Position the cursor where you want text to appear.
4. Use the stylus to write anywhere on the screen. The handwriting will be converted to text shortly after you lift the stylus from the screen.

### To enter punctuation and symbols

Transcriber comes with an on-screen keyboard that provides an easy way to add punctuation or a special symbol to existing text. To use this on-screen keyboard, tap  on the Transcriber toolbar.

The keyboard remains visible until you tap the button again.

- Tips**
- To reposition the keyboard, tap and hold the title bar, then drag to the desired location.
  - When no text is selected, you can also open the keyboard by doing the  gesture. For more information about using Transcriber gestures, see Help on the device.

### To edit text

1. In a program, draw a line across the text you want to edit.
2. After you lift the stylus from the screen, the line will disappear and the selected text will be highlighted.
3. Do either of the following:
  - Rewrite the text.
  - Use gestures to capitalize letters, insert a space, and so on. For information about using Transcriber gestures, see Help on the device.

## 2.7 Searching Information

You can search for files and other items stored in My Documents folder or on an installed storage card of your XV6900. You can search by file name or by words located in the item. For example, you can search in e-mail messages, notes, appointments, contacts, and tasks, as well as in online Help.

### To search for a file or an item

1. Tap **Start > Programs > Search**.
2. In the **Search for** field, you can:
  - Enter the file name, word, or other information you want to search for.
  - Tap the down arrow icon (▼), and from the list, select one item that you have looked for before.
3. In the **Type** field, you can tap the down arrow icon (▼) and select a data type from the list to help narrow your search.
4. Tap **Search**. The system then starts searching the matched files in the **My Documents** folder and subfolders.
5. In the **Results** list, tap the item you want to open.

**Note** The storage card symbol ( or ) is displayed next to the names of files saved on a storage card.



# Chapter 3

## Using Phone Features

**3.1 Using the Phone**

**3.2 Making a Call**

**3.3 Receiving a Call**

**3.4 Smart Dialing**

**3.5 Additional Dialing Information**



## 3.1 Using the Phone

Like a standard mobile phone, you can use your device to make, receive, and keep track of calls and send messages.

### The Phone screen

From the Phone screen, you can access Call History, Speed Dial, and Phone settings. To open the Phone screen, do one of the following:

- Tap **Start > Phone**; or
- Press the TALK button.

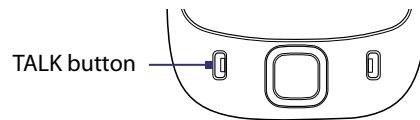

### Turn the phone function on and off

In many countries, you are required by law to turn off the phone while on board an aircraft.

#### To enable or disable the phone function

1. Tap **Start > Programs > Comm Manager** or tap **Start > Settings > Connections tab > Comm Manager**.
2. On the Comm Manager screen, tap the **Phone** button to enable or disable the phone function. When enabled, the ON indicator is activated.

#### To enable or disable Airplane Mode

Another way to turn off the phone function is to switch your device to **Airplane mode**.

When you enable Airplane Mode, all wireless radios on your device are turned off, including the phone function and Bluetooth.

When you disable Airplane Mode, the phone function is turned back on and the previous states of Bluetooth.

1. Tap **Start > Programs > Comm Manager** or tap **Start > Settings > Connections tab > Comm Manager**.
2. On the Comm Manager screen, tap the **Airplane Mode** button to enable or disable Airplane Mode. When enabled, the ON indicator is activated.

### Adjust the device volume

1. Tap the **Speaker** icon (🔊).
2. Under **Volume**, do the following:
  - Adjust the phone volume (🔊) or device volume (📞) by moving the slider to the desired volume level.
  - Tap **On**, **Vibrate**, or **Off** to change both the system and ringer volume settings.

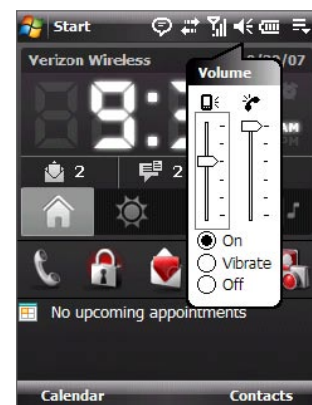

- Notes**
- To adjust the conversation phone volume, you must do it during a call. Adjusting the volume at another time will affect the ring, notification, and MP3 sound levels.
  - When you activate Vibrate mode, sound will automatically be muted and your device will vibrate when an incoming call is received. The Vibrate icon (📞) will appear in the title bar to indicate that Vibrate mode is activated.

## 3.2 Making a Call

With your device, you can make a call from **Phone**, **Contacts**, **Speed Dial**, and **Call History**.

### Make a call from Phone

1. Tap **Start > Phone** or press the TALK button.
2. On the Phone keypad, simply touch the keys with your finger or tap the keys using the stylus to enter the phone number.
3. Press the TALK button on your device to place the call.

**Tip** If you tap a wrong number, tap **Delete** (  ) to erase each subsequent digit of a number. To erase the entire number, tap and hold **Delete**.

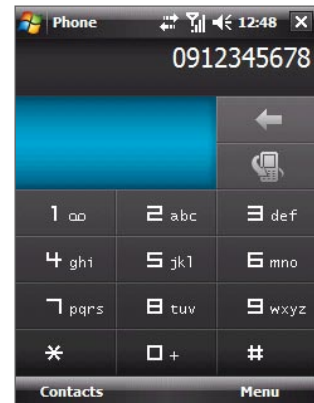

### Make a call from Contacts

Tap **Contacts** on the Today screen or tap **Start > Contacts**, then do one of the following:

- Press NAVIGATION up or down to select a contact, and press TALK.
- Tap the desired contact in the contacts list, and tap the phone number that you want to call.
- Tap and hold the desired contact, and on the shortcut menu, tap **Call Work**, **Call Home**, or **Call Mobile**.

### To choose one of the numbers of a contact to dial

By default, the mobile phone number (m) of a contact is dialed when you make a call from Contacts. However, you can specify that a different phone number is dialed instead.

1. Tap **Start > Contacts**.
2. Press NAVIGATION up or down to select the contact.
3. Press NAVIGATION left or right. The letters representing the number will change as you scroll through them.

### Make a call from TouchFLO

To place a call to a favorite contact that you added to TouchFLO's Touch Cube, follow these steps:

1. Open the Touch Cube by sliding your finger upward, starting from the logo at the bottom of the touch screen. (See Chapter 1 for detailed instructions.)
2. Slide your finger left or right to rotate the cube and navigate to the screen where it shows your favorite contacts.
3. Touch the photo or name of the favorite contact to dial the phone number.

### Make a call from Call History

1. On the Phone screen, tap the **Call History** button (  ) or tap **Menu > Call History**.
2. You can either finger-scroll through all calls in Call History, or tap **Menu > Filter** and select from a category of call types.
3. Finger-scroll to the desired contact or phone number, and tap **Call**.

## One-touch Speed Dial

Use **Speed Dial** to call frequently-used numbers with a single tap. For example, if you assign a contact to the location **2** in Speed Dial, you can simply tap and hold the  key on the Phone screen to dial the contact's number.

### To create a Speed Dial entry

Before you can create a Speed Dial entry, the number must already exist in Contacts.

1. On the Phone screen, tap **Menu > Speed Dial**.
2. Tap **Menu > New**.
3. Tap a contact. Select the phone number that you want to add to be assigned with a speed dial key.
4. In the **Location** box, select an available key to use as the speed dial key.

**Note** If you want to place a phone number in a position that is already occupied, the new number will replace the number that is already there.

**Tip** To delete a Speed Dial entry, in the **Speed Dial** list, tap and hold the desired entry, and tap **Delete**.

### To call voicemail

The location **1** is generally reserved for your voicemail. Tap and hold the  key on the Phone screen to call voicemail.

## 3.3 Receiving a Call

When you receive a phone call, a message will appear, giving you the option to either answer or ignore the incoming call.

### To answer or reject an incoming call

- To answer the call, tap **Answer**, or press TALK on the device.
- To reject the call, tap **Ignore**, or press END on the device.

### To end a call

Once an incoming or outgoing call is in progress, you can tap **End** or press END on the device to hang up.

### To check a missed call

You will see the  icon on top of the screen when you missed a call. To check who the caller is:

- Tap the  icon, then tap **View**; or
- On the Phone screen, tap the **Call History** button (  ). You can view missed calls as well as incoming and outgoing calls in Call History.

## To put a call on hold

Your device notifies you when you have another incoming call, and gives you the choice of rejecting or accepting the call. If you are already on a call and accept the new call, you can choose to switch between the two callers, or set up a conference call between all three parties.

1. Tap **Answer** to take the second call, and put the first one on hold.
2. To end the second call and return to the first call, tap **End** or press END on the device.

## To switch between two calls

- Tap **Swap**.

## To set up a conference call

1. Either put a call on hold, and dial a second number; or, accept a second incoming call when you already have one in progress.
2. Tap **Menu > Conference**.

**Note** Not all service providers support conference calling. Contact your service provider for details.

## To turn on and off the Speakerphone

The built-in Speakerphone on your device allows you to talk hands-free or lets other people listen to the conversation.

- During a call, tap **Speaker On**, or press and hold TALK until the speakerphone turns on. The speakerphone icon (  ) appears in the title bar.
- To turn off the speakerphone, tap **Speaker Off**, or press and hold TALK again until the speakerphone turns off.

**Warning!** To avoid damage to your hearing, do not hold your device against your ear when the Speakerphone is turned on.

## To mute a call

You can turn off the microphone during a call, so that you can hear the caller but the caller cannot hear you.

- During a call, tap **Mute**.
- When the microphone is turned off, the mute icon (  ) appears on the screen. Tap **Unmute** to turn on the microphone again.

## 3.4 Smart Dialing

**Smart Dialing** makes it easy for you to dial a phone number.

When you start entering a phone number or contact name, Smart Dialing will automatically search and sort the contact entries in Contacts and the phone numbers in Call History (including incoming, outgoing, and missed calls). You can then select the desired number or contact from the filtered list to dial.

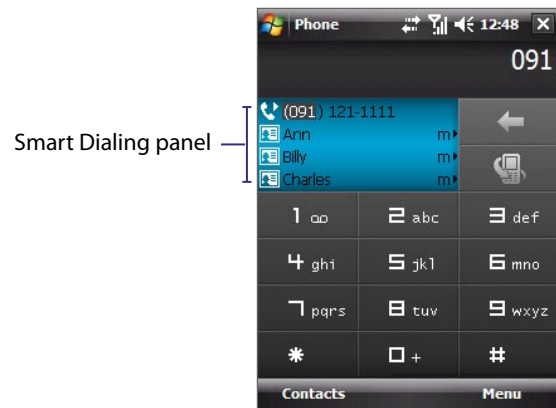

### Tips on using Smart Dialing

Smart Dialing starts looking for numbers or contacts that match the sequence you have entered. Below are some tips on how to use Smart Dialing to quickly find a desired phone number or contact.

#### To find a phone number

- Simply enter the first one or two digits to find a phone number in Call History.
- Enter the first three digits or more if you want to find a phone number from the saved contacts on your device.

#### To find a contact name

You can just enter the first letter of a contact's first name or surname. Smart Dialing will search for the letter starting from the first character of a contact name as well as from the character that appears after a space, dash, or underscore in a contact name. For example, if you tap number "2" which is associated with [a, b, c] on the Phone keypad, contact names such as the following will be considered matches: "Ben Miller", "George Adams", "John-Carter", "Carter, Ellen", "Dixon, Allan", "Thomas\_Clark", "JaneCampbell".

If the matching list is long and you want to narrow down the search further, enter another letter. Using the same example above, if you continue to tap "3" which is associated with [d, e, f], the matching list will be narrowed down to the following names: "Ben Miller", "George Adams", "Carter, Ellen", "Dixon, Allan".

### Make a call or send a text message using Smart Dialing

1. Press the TALK button on your device to open the Phone screen.
2. Begin entering the first few numbers or characters.
 

When you start entering a number or letter, the Smart Dialing panel will display matches found.
3. In the Smart Dialing panel, browse the list by sliding your finger or the stylus up or down or by pressing NAVIGATION up or down.
4. You can do one of the following:
  - When the desired contact is selected, press the TALK button to place a call.
  - To send a text message to the selected contact, tap and hold the contact, and tap **Send Text Message**.
  - To call a different phone number associated with the selected contact, tap and hold the selected contact, and tap the phone number you want to call.

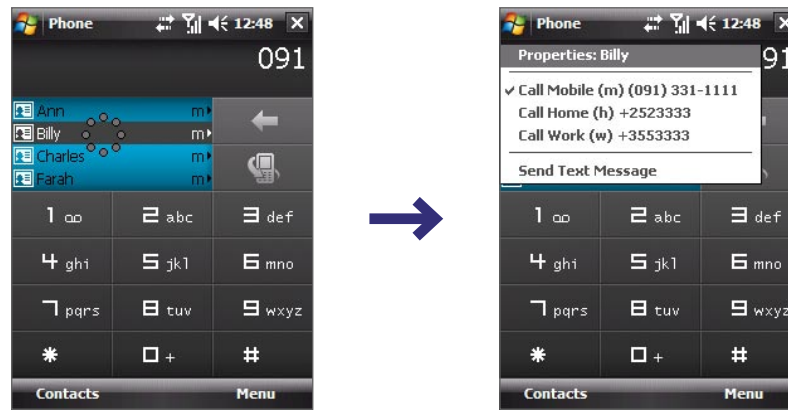

Tap and hold the contact to pop up the shortcut menu.

**Tip** To view or edit information associated with the selected contact, tap the contact's name on the shortcut menu (applies only to entries stored in Contacts on your device).

## Set up Smart Dialing

1. On the Phone screen, tap **Menu > Smart Dialing Options**.
2. On the **Options** tab, select the **Enable Smart Dialing** check box.
  - Select the **Automatically expand selected contact** check box to enable a contact's name and phone number to be displayed when the contact is selected in the matching list.
  - Select the **Enable drag-scroll** check box to scroll in the matched list by dragging.
  - Select the **Enable double-click for dialing** check box to make a voice call by double-tapping the item in the matched list.

## 3.5 Additional Dialing Information

### Make an emergency call

Enter the appropriate emergency number for your locale, and press the TALK button on your device.





# Chapter 4

## Setting Up Your XV6900

**4.1 Basic Settings**

**4.2 Personalizing the Today Screen**

**4.3 Customizing Phone Services**

**4.4 Protecting Your XV6900**



## 4.1 Basic Settings

### Time and date

#### To set the time and date

1. Tap **Start > Settings > System tab > Clock & Alarms > Time** tab.
2. Select the correct time zone and change the date or time.

**Note** During synchronization, the time on your XV6900 is updated with the time on your PC.

#### To set the time and date for a different location

If you visit or communicate with someone in a particular time zone often, you can select it as your visiting time zone.

1. Tap **Start > Settings > System tab > Clock & Alarms > Time** tab.
2. Tap **Visiting**.
3. Select the correct time zone and change the time or date.

### Regional settings

The style in which numbers, currency, dates, and times are displayed is specified in regional settings.

1. Tap **Start > Settings > System tab > Regional Settings**.
2. On the **Region** tab, select your region from the list.

**Note** This does not change the Operating System language of your XV6900.

3. The region you select determines which options will be available on the other tabs.
4. To customize settings further, tap the appropriate tabs and select the desired options.

### Display settings

#### To adjust screen brightness

- On the Today screen, tap the **Launcher** tab of HTC Home, and then tap the **Backlight Adjust** icon () to toggle among the brightness levels; or
- Tap **Start > Settings > System tab > Backlight > Brightness** tab and then move the slider to adjust the brightness.

#### To set the backlight to dim after a time delay

1. Tap **Start > Settings > System tab > Backlight**.
2. Tap the **Battery power** tab, or the **External power** tab.
3. Select the **Turn off backlight if device is not used for** check box, and specify the time delay.

#### To increase or decrease the size of text on the screen

1. Tap **Start > Settings > System tab > Screen > Text Size** tab.
2. Move the slider to increase or decrease the text size.

## Device name

The device name is used to identify your XV6900 in the following situations:

- Synchronizing with a PC
- Connecting to a network
- Restoring information from a backup

**Note** If you synchronize multiple devices with the same PC, each device must have a unique name.

### To change the device name

1. Tap **Start > Settings > System tab > About**.
2. Tap the **Device ID** tab.
3. Enter a name.

**Note** The device name must begin with a letter, consist of letters from **A** to **Z**, numbers from **0** to **9**, and cannot contain spaces. Use the underscore character to separate words.

## Ringer settings

### To change the ring type and ring tone

1. On the Phone screen, tap **Menu > Options > Phone tab**.
2. In the **Ring type** list, choose whether to be notified of incoming calls by a ring, a vibration, or a combination of both.
3. In the **Ring tone** list, tap the sound you want to use.

**Tip** You can use **\*.wav**, **\*.mid**, **\*.mp3**, **\*.wma**, or other types of sound files that you downloaded from the Internet or copied from your PC as ring tones. For a complete list of supported audio file formats for ring tones, see "Specifications" in the Appendix.

**To** use your sound files as ring tones, copy them first to the **/My Documents/My Ringtones** folder on your XV6900, then select the sound from the **Ring tone** list of your XV6900. For more information about copying files, see Chapter 9.

## Alarms and notifications

### To set an alarm

1. Tap **Start > Settings > System tab > Clock & Alarms > Alarms tab**.
2. Tap **<Description>** and enter a name for the alarm.
3. Tap the day of the week for the alarm. You can select multiple days by tapping each desired day.
4. Tap the time to open a clock and set the time for the alarm.
5. Tap the alarm icon (  ) to specify the type of alarm you want. You can choose a flashing light, a single sound, a repeating sound, or vibration.
6. If you choose to play a sound, tap the list next to the **Play sound** check box and tap the sound you want.

### To choose how to be notified about events or actions

1. Tap **Start > Settings > Personal tab > Sounds & Notifications**.
2. On the **Sounds** tab, choose how you want to be notified by selecting the appropriate check boxes.
3. On the **Notifications** tab, in **Event**, tap an event name and choose how you want to be notified by selecting the appropriate check boxes. You can choose from several options, such as a special sound, a message, or a flashing light.

**Tip** Turning off sounds and the flashing light helps conserve battery power.

## 4.2 Personalizing the Today Screen

The Today screen shows your upcoming appointments, active tasks, and information about incoming messages. You can customize what to display on the Today screen.

### To customize the Today screen

1. Tap **Start > Settings > Personal tab > Today**.
2. On the **Appearance** tab, select the desired theme for the background of the Today screen.
3. On the **Items** tab, select the items you want to appear on the Today screen.

### To use a custom background image

You can use one of your own pictures as the background image on the Today screen.

1. Tap **Start > Settings > Personal tab > Today**.
2. Select the **Use this picture as the background** check box, and tap **Browse** to view a list of your picture files.
3. Tap the file name of the picture you want to use.
4. Tap **OK**.

### To display owner information

Having owner information displayed on the Today screen makes it easier for someone to return your XV6900 to you if it is lost.

1. Tap **Start > Settings > Personal tab > Owner Information**.
2. On the **Identification** tab, enter your personal information.

**Tips**

- If you don't see owner information on the Today screen, tap **Start > Settings > Personal tab > Today**. On the **Items** tab, select the **Owner Info** check box.
- You can set your XV6900 to display the 'my info' screen when your XV6900 is turned on. This screen shows your complete personal information. To display the 'my info' screen, tap **Start > Settings > Personal tab > Owner Information > Options** tab then select the **Identification information** check box.

### To set options for displaying appointments on the Today screen

If you have a large number of appointments, you may want to specify the kind of appointments that are displayed on the Today screen.

1. Tap **Start > Settings > Personal tab > Today**.
2. Tap the **Items** tab.
3. Select **Calendar** and tap **Options**.

4. Do any of the following:
  - Select **Next appointment** to show only the next appointment in your schedule, or **Upcoming appointments** to show multiple appointments.
  - Clear the **Display all day events** check box if you do not want to display all-day events.

For more information about using Calendar, see Chapter 6 and 8.

### To set options for displaying tasks on the Today screen

If you have a large number of tasks, you may want to specify the kind of tasks that are displayed on the Today screen.

1. Tap **Start > Settings > Personal tab > Today**.
2. Tap the **Items** tab.
3. Select **Tasks** and tap **Options**.
4. Do any of the following:
  - Under **Display number of**, select the type of tasks you want to appear on the Today screen.
  - In the **Category** list, select whether to display only tasks assigned to a specific category or to display all tasks.

For more information about creating tasks on your XV6900, see Chapter 6.

## Customize the Start menu

### To customize the Start Menu

You can choose which items appear in the **Start** menu.

1. Tap **Start > Settings > Personal tab > Menus**.
2. Select the check boxes of the items you want to appear in the **Start** menu. You can select up to seven items.

**Tip** You can also create folders and shortcuts to appear on the Start menu. Using Windows Explorer on your PC, navigate to the **/Windows/Start Menu** folder of the device, then create the folders and shortcuts that you want. You will see the added items on the device after you synchronize. For information about synchronizing your XV6900 with the computer, see Chapter 5.

### To change the Start Menu display size

The Large Start Menu feature enlarges the Start menu to make it easier to touch menu items with your fingers. When the Large Start Menu is enabled, recently accessed programs are displayed as icons at the top of the Start menu.

1. Tap **Start > Settings > Personal tab > Large Start Menu**.
2. Select the **Enable large Start menu** check box to enlarge the Start menu or clear the check box to resume the normal display of the Start menu.

## The End Key and the Quick List

Use the Long Press End Key setting to set the behavior of the END Key when it is held down.

1. Tap **Start > Settings > System tab > Long Press End Key**.
2. Do one of the following:
  - Select the **Always display the Quick List** option to display the Quick List screen when you hold down the END Key; or
  - Select the **Automatically execute the selected action** option and then select which function will be executed automatically when you hold down the END Key. The functions available for selection are the same as the ones in the Quick List.

## 4.3 Customizing Phone Services

### To access phone settings and services



- Tap **Start > Phone**, then tap **Menu > Options** on the Phone screen; or
- Tap **Start > Settings > Phone**.

### To enable optional phone services

Optional phone services can be easily activated and used on your XV6900 if provided by your wireless service provider. Some of these services may not be available on your XV6900. Contact your service provider first to ask about the availability of these services.

1. Tap **Start > Settings > Personal tab > Phone > Services** tab.
2. Select the service you want to use, then tap **Get Settings**.
3. Select desired options for the service, then tap **OK**.

The following are some of the optional phone services that you may find on your XV6900.

Phone Services	Usage
<b>Location Setting</b>	<p>Allow the mobile phone network to detect your current location via your XV6900's built-in GPS chip. This is especially useful in times of emergency.</p> <p>On the upper right of the Phone screen, one of these icons will be shown:</p> <p> <b>ON</b> (your location can be detected)</p> <p> <b>OFF</b> (your location cannot be detected except by 911)</p>
<b>Network Service</b>	Choose whether to restrict your XV6900 to phone calls from your home network only.
<b>TTY Mode</b>	Allow the use of a TTY (teletypewriter) device with the device for users who are visually or hearing impaired.
<b>Time Synchronization</b>	Choose whether or not to synchronize the time on your XV6900 with the mobile network.

## 4.4 Protecting Your XV6900

### Protect your XV6900 with a password

You can prevent unauthorized access to your XV6900 by using password protection. To keep your data more secure, you can set your XV6900 to prompt for a password every time the device is turned on or when your XV6900 has been idle after a specified amount of time.

#### To set a device password

1. Tap **Start > Settings > Personal** tab > **Lock**.
2. Select the **Prompt if device unused for** check box, and in the box to the right, select how long your XV6900 must be idle before a password is required. In the **Password type** box, select the type of password you would like to use. Enter the password and, if necessary, confirm the password.  
  
If your XV6900 is configured to connect to a network, use an alphanumeric password for increased security for your XV6900.
3. On the **Hint** tab, enter a phrase that will help you remember your password, but does not allow others to guess your password.  
  
The hint will be displayed after the wrong password is entered four times.
4. Tap **OK**. The next time the device is turned on, you will be prompted to enter your password.

- Notes**
- Each time a wrong password is entered, the device response time gets longer until the device appears to be not responding.
  - If you forget your password, you must follow the instructions in this user manual to clear the memory before you can access your XV6900.

#### To change your password

1. Tap **Start > Settings > Personal** tab > **Lock**. You will be prompted to enter your current password.
2. In the **Password** box, enter your new password.
3. Tap **OK**.

### Encrypt files on your storage card

You can set your XV6900 to encrypt files as they are saved on the storage card.

1. Tap **Start > Settings > System** tab > **Encryption**.
2. Select **Encrypt files placed on storage cards**.

**Note** Encrypted files are opened just like other files, provided you are using the device that encrypted them. There is no separate step for you to take to read these files.

**Important** If **Encrypt files on your storage cards** is or was enabled before, then backup all files from the storage card before using Clear Storage, hard reset or updating the ROM system software. Otherwise you will no longer be able to access the encrypted files on the storage card. Use ActiveSync or Windows Mobile Device Center to transfer files between your storage card and computer. After the procedure, copy your files back to the storage card.





# Chapter 5

## Synchronizing Information With Your Computer

### 5.1 About Synchronization

### 5.2 Setting Up Windows Mobile® Device Center on Windows Vista®

### 5.3 Setting Up ActiveSync® on Windows XP®

### 5.4 Synchronizing With Your Computer

### 5.5 Synchronizing via Bluetooth

### 5.6 Synchronizing Music and Video



## 5.1 About Synchronization

You can take information from your computer wherever you go by synchronizing them to your XV6900. The following types of information can be synchronized between your computer and your XV6900:

- **Microsoft Outlook® information**, which include Outlook e-mail, contacts, calendar, tasks, and notes
- **Media**, such as pictures, music and video
- **Favorites**, which are the bookmarked links to your favorite Web sites
- **Files**, such as documents and other files

Before you can synchronize, you need to install and set up first the synchronization software on your computer. For more information, see “Setting Up Windows Mobile Device Center on Windows Vista®” and “Setting Up ActiveSync® on Windows XP®”.

### Ways to synchronize

After you have installed the synchronization software to your computer, connect and synchronize your XV6900 with your computer by using one of the following methods:

- Connect and synchronize using the supplied Mini USB cable.  
Upon connecting the Mini USB cable to the device and your computer, the synchronization process starts automatically.
- Connect and synchronize using Bluetooth.  
You must first set up a Bluetooth partnership between your XV6900 and your computer before you can synchronize information between them using Bluetooth. For more information about setting up a Bluetooth partnership, see Chapter 10. For information about synchronizing through Bluetooth, see “Synchronizing via Bluetooth” later in this chapter.

Try to synchronize frequently in order to keep information up-to-date in both your XV6900 and your computer.

**Note** You can also synchronize Outlook e-mail, contacts, calendar, and tasks on your XV6900 with the Exchange Server at your work. For more information about setting up your XV6900 to synchronize with the Exchange Server, see Chapter 8.

## 5.2 Setting Up Windows Mobile® Device Center on Windows Vista®

**Microsoft Windows Mobile® Device Center** is the replacement for Microsoft® ActiveSync® on Windows Vista®.

**Note** Some versions of Windows Vista come with Windows Mobile Device Center already installed. If Windows Mobile Device Center is not available on your Windows Vista, you can install it from the Getting Started Disc that came with your XV6900.

### Set up synchronization in Windows Mobile Device Center

When you connect your XV6900 to your PC and start Windows Mobile Device Center for the first time, you are asked to create a Windows Mobile partnership with your XV6900. Follow the steps below to create a partnership.

1. Connect the device to your PC. Windows Mobile Device Center configures itself and then opens.
2. On the license agreement screen, click **Accept**.
3. On the Windows Mobile Device Center’s Home screen, click **Set up your device**.

**Note** Choose **Connect without setting up your device** if you only want to transfer media files, check for updates, and explore the device but not sync Outlook information.



4. Select the items you want to synchronize, then click **Next**.
5. Enter a device name and click **Set Up**.

When you finish the setup wizard, Windows Mobile Device Center synchronizes your XV6900 automatically. Notice that Outlook e-mails and other information will appear on the device after synchronization.

## Use Windows Mobile Device Center

To open Windows Mobile Device Center, click **Start > All Programs > Windows Mobile Device Center** on your Windows Vista computer.



On Windows Mobile Device Center, you can do the following:

- Click **Mobile Device Settings** to change synchronization settings.
- When you click **Pictures, Music and Video > \_\_\_ new pictures/video clips are available for import**, a wizard guides you to tag and transfer photos from your XV6900 to the Photo Gallery on your Windows Vista PC.
- Click **Pictures, Music and Video > Add media to your device from Windows Media Player** to synchronize music and video files using Windows Media™ Player. For more information, see “Windows Media® Player Mobile” in Chapter 11.
- Click **File Management > Browse the contents of your device** to view documents and files from your XV6900.

**Note** See Windows Mobile Device Center Help for more information.

## 5.3 Setting Up ActiveSync® on Windows XP®

The Getting Started Disc that comes with your XV6900 contains Microsoft ActiveSync 4.5 or later. Follow the steps in this section to install and set up ActiveSync on Windows XP or other compatible Windows systems.

**Note** For a list of compatible Windows systems, please go to <http://www.microsoft.com/windowsmobile/activesync/activesync45.msp>.

### Install ActiveSync

1. Insert the Getting Started Disc into the disc drive on your PC.
2. Click **Setup and Installation**.
3. Select the **ActiveSync** check box and click **Install**.
4. Read the license terms and click **Accept**.
5. When installation is complete, click **Done**.
6. On the Getting Started with Windows Mobile screen, click **Close**.

### Set up synchronization in ActiveSync

Follow the steps below to set up a synchronization partnership.

1. Connect the device to your PC. The Synchronization Setup Wizard automatically starts and guides you to create a synchronization partnership. Click **Next** to proceed.
2. To synchronize your XV6900 with your PC, clear the **Synchronize directly with a server running Microsoft Exchange** check box then click **Next**.
3. Select the information types that you want to synchronize then click **Next**.
4. Select or clear the **Allow wireless data connections** check box according to your preference.
5. Click **Finish**.

When you finish the wizard, ActiveSync synchronizes your XV6900 automatically. Notice that Outlook e-mails and other information will appear on the device after synchronization.

## 5.4 Synchronizing With Your Computer

Connect and synchronize your XV6900 with your PC using the USB cable or Bluetooth connection.

### Start and stop synchronization



You can manually synchronize either from your XV6900 or PC.

#### From your XV6900

- Tap **Start > Programs > ActiveSync.**, then tap **Sync.** To end synchronization before it completes, tap **Stop.**



**Tip** To delete a partnership with one PC completely, disconnect the device from that PC first. In ActiveSync on your XV6900, tap **Menu > Options**, tap the computer name, then tap **Delete.**

#### From Windows Mobile Device Center

1. Click **Start > All Programs > Windows Mobile Device Center.**
2. Click  at the lower left of the Windows Mobile Device Center. To end synchronization before it completes, click .

#### From ActiveSync on your PC

When you connect your XV6900 to your PC, ActiveSync automatically opens on your PC and synchronizes.

- To manually start synchronization, click .
- To end synchronization before it completes, click .

### Change which information is synchronized

You can change the information types and the amount of information to synchronize for each type either on your XV6900 or your PC. Follow the steps below to change synchronization settings on your XV6900.

**Note** Before changing synchronization settings on your XV6900, disconnect it from your PC.

1. In ActiveSync on your XV6900, tap **Menu > Options.**
2. Select the check box for any items you want to synchronize. If you cannot select a check box, you might have to clear the check box for the same information type elsewhere in the list.
3. To change synchronization settings for an information type, for instance, **E-mail**, select it and tap **Settings.**

You can then set the download size limit, specify the time period of information to download, and more.

- Notes**
- Some information types such as Favorites, Files and Media cannot be selected in ActiveSync Options on your XV6900. You can only select or clear these items from your PC's Windows Mobile Device Center or ActiveSync.
  - A PC can have sync partnerships with many different Windows Mobile powered devices, but a device can have sync partnerships with at most two PCs only. To ensure that your XV6900 will synchronize properly with both PCs, set up the second PC using the same synchronization settings you used on the first PC.
  - Outlook e-mail can be synchronized with only one computer.

### Troubleshoot sync connection problem

When the PC is connected to the Internet or a local network, in some cases, the PC may disconnect the connection with your XV6900 in favor of the Internet or network connection.

If this happens, tap **Start > Settings > Connections tab > USB to PC**, then clear the **Enable advanced network functionality** check box. This makes your PC utilize a serial USB connection with your XV6900.

The **USB to PC** () icon appears on the Today Screen when serial USB connection is used.

## 5.5 Synchronizing via Bluetooth

You can connect and synchronize your XV6900 with the PC using Bluetooth.

### To synchronize with a computer via Bluetooth

1. Set up Windows Mobile Device Center or ActiveSync on your PC to synchronize through Bluetooth. See the program's Help for instructions.
2. On your XV6900, tap **Start > Programs > ActiveSync**.
3. Make sure that Bluetooth on both your XV6900 and the computer are turned on and set to visible mode. For more information, see "Bluetooth" in Chapter 10.
4. Tap **Menu > Connect via Bluetooth**. Make sure the Bluetooth function of both your XV6900 and the computer are turned on and set to visible mode.
5. If this is the first time you have connected to this computer via Bluetooth, you must first complete the Bluetooth wizard on your XV6900 and set up a Bluetooth partnership between your XV6900 and the computer. For more information about creating a Bluetooth partnership, see "Bluetooth partnerships" in Chapter 10.

- Notes**
- To preserve battery power, turn off Bluetooth when not in use.
  - To connect and synchronize your XV6900 with a computer via Bluetooth, your computer must have built-in Bluetooth or installed with a Bluetooth adapter or dongle.

## 5.6 Synchronizing Music and Video

If you want to carry your music or other digital media along with you while you travel, set up Microsoft® Windows Media® Player on your computer to synchronize music and video with your XV6900.

Other than selecting the **Media** information type to be synchronized, all media synchronization settings must be set in Windows Media Player. Before media can be synchronized, you must do the following:

- Install Windows Media Player Version 11 on the PC. (Windows Media Player 11 works only in Windows XP or later versions).
- Connect your XV6900 to the PC with a USB cable. If your XV6900 is currently connected using Bluetooth, you must end that connection before media can be synchronized.
- Set up a sync partnership between your XV6900 and your PC's Windows Media® Player.

For more information about using Windows Media® Player Mobile, see Chapter 11.

# Chapter 6

## Organizing Contacts, Appointments, Tasks, and Other Information

**6.1 Contacts**

**6.2 Calendar**

**6.3 Tasks**

**6.4 Notes**

**6.5 Voice Recorder**



## 6.1 Contacts

**Contacts** is your address book and information storage for the people and businesses you communicate with. Store phone numbers, e-mail addresses, home addresses, and any other information that relates to a contact, such as a birthday or an anniversary date. You can also add a picture or assign a ring tone to a contact.

From the contact list, you can quickly communicate with people. Tap a contact in the list for a summary of contact information. From there, you can call or send a message.

**Tip** If you use Outlook on your PC, you can synchronize contacts between your XV6900 and PC.

### Add new contacts

#### To add a contact on your XV6900

1. Tap **Start > Contacts**.
2. Tap **New**, select **Outlook Contact**, and enter the contact information.
3. In the **File as** field, choose how you want the contact name to appear in the contact list.
4. To add a photo of the contact, tap **Select a picture**, then select the picture file or tap **Camera** to take a photo of the contact. This photo appears on the Phone screen when you receive a call from the contact.
5. To assign a ring tone to the contact, tap the **Ring tone** field, scroll through the list of tones, then select a desired tone.
6. When finished, tap **OK**.

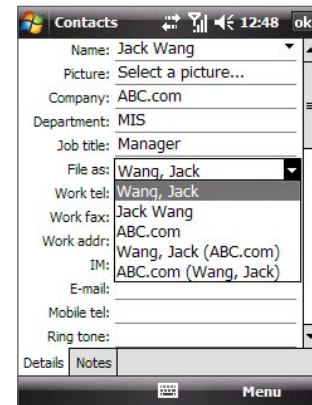

- Notes**
- If someone who is not in your list of contacts calls you, you can create a contact from Call History by tapping and holding a phone number and then tapping **Save to Contacts** from the shortcut menu.
  - To save a phone number that is contained in a message, tap the phone number, then tap **Menu > Save to Contacts**.
  - To edit contact information, tap the contact name then tap **Menu > Edit**.

### View, organize and search

#### To view contact information

1. Tap **Start > Contacts**.
2. Slide your finger upward on the touch screen to scroll down the contact list.  
To scroll up the contact list, slide your finger downward on the touch screen.
3. Touch the name of a contact to open his or her contact card.
4. On the contact card, you will see the last outgoing or incoming call as well as detailed information such as phone numbers of the contact, e-mail address, and more.

**Note** For detailed instructions on how to use finger scrolling, see "Finger scrolling and finger panning" in Chapter 1.

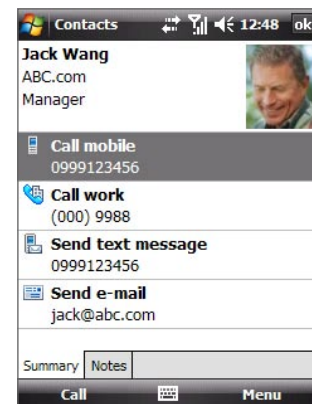



### To group similar contacts

You can group similar contacts for easier management by assigning them to categories.

1. Create a new Outlook contact or edit an existing Outlook contact.
2. Tap **Categories**.
3. Select a preset category such as Business or Personal, or tap **New** to create your own category.
4. When finished, tap **OK**.

### To view contacts by category

- Tap **Menu > Filter** then select the desired category.

### To find a contact on your XV6900

There are several ways to find a contact when your contact list is long.

1. Tap **Start > Contacts**.
2. Do one of the following:
  - Begin entering a contact name in the provided text box until the contact you want is displayed.
  - Use the alphabetical index displayed at the top of the contact list.
  - Filter the list by categories. In the contact list, tap **Menu > Filter**, then tap a category you've assigned to a contact. To show all contacts again, select **All Contacts**.

## Share contact information

### To beam a contact's details

You can quickly send contact information to another mobile phone or device through Bluetooth beaming.

1. Tap **Start > Contacts**, then select a contact.
2. Tap **Menu > Send Contact > Beam** then select a device where to beam the contact to.

**Note** Before you can beam, make sure Bluetooth is turned on and set to visible mode on your XV6900 and the target mobile device. You can also beam contact information to your PC. See "Bluetooth" in Chapter 10 for details.

## 6.2 Calendar

Use **Calendar** to schedule appointments, including meetings and other events. Your appointments for the day can be displayed on the Today screen. If you use Outlook on your PC, you can synchronize appointments between your XV6900 and PC. You can also set Calendar to remind you of appointments with a sound or flashing light, for example.

You can look at your appointments in several different views (Day, Week, Month, Year, and Agenda). To see detailed appointment information in any view, tap the appointment.

### Create appointments

#### To schedule an appointment

1. Tap **Start > Calendar**.
2. Tap **Menu > New Appointment**.
3. Enter a name for the appointment.
4. Do one of the following:
  - If it is a special occasion such as a birthday or a whole-day event, set the **All Day** option to **Yes**.
  - If there is a time frame for the appointment, select the start and end dates and time.
5. Specify the type of category for your appointment, so that it can be grouped with other related appointments. Tap **Categories**, then select a preset category (Business, Holiday, Personal, or Seasonal), or tap **New** to create your own category.
6. When finished, tap **OK** to return to the calendar.

**Notes**

- All-day events do not occupy blocks of time in Calendar; instead, they appear in banners at the top of the calendar.
- To cancel an appointment, tap **Menu > Delete Appointment**.

**Tip** To have the time entered automatically in Day view, tap the time slot for the new appointment, and tap **Menu > New Appointment**.

#### To set a default reminder for all new appointments

You can have a reminder automatically turned on for all new appointments you schedule.

1. Tap **Start > Calendar**.
2. Tap **Menu > Tools > Options > Appointments** tab.
3. Select the **Set reminders for new items** check box.
4. Set the time when you want the reminder to alert you.
5. Tap **OK** to return to the calendar.

## View appointments

By default, Calendar displays appointments in **Agenda** view. You can also look at your appointments in **Day**, **Week**, **Month**, and **Year** views.

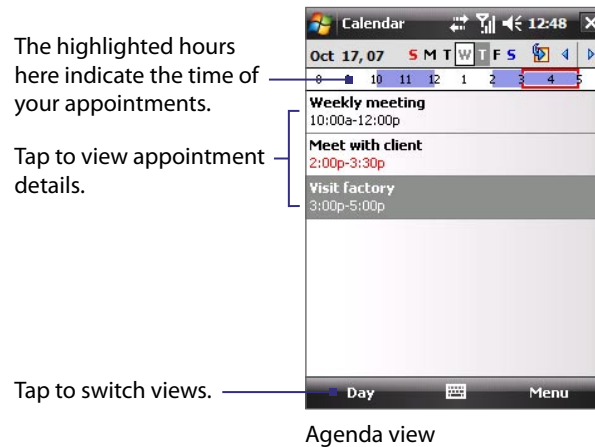

- To see detailed appointment information in any view, tap the appointment.
- To view appointments by category, tap **Menu > Filter** then select the desired category.
- To change the default view that Calendar uses to display appointments, tap **Menu > Tools > Options > General** tab. Tap the **Start in** box then choose the calendar view.
- When in Month view, you will see the following indicators:
 

	Morning appointment		Afternoon or evening appointment
	All-day event		Both morning and afternoon/evening appointments

## Send appointments

### To send a meeting request

Use Calendar to schedule meetings via e-mail with contacts who use Outlook or Outlook Mobile.

1. Tap **Start > Calendar**.
2. Schedule a new appointment, or open an existing one and tap **Menu > Edit**.
3. Tap **Attendees**, then tap **Add Required Attendee** or **Add Optional Attendee** and add the contacts whom you want to invite.

You can specify if an attendee is required or optional only if your XV6900 is connected to a Microsoft Exchange 2007 server. Otherwise, all attendees are designated as required. For more information, see Chapter 8.

4. When you have finished adding attendees, tap **Done**.
5. Tap **OK** to send.

**Tip** To choose the e-mail account to use for sending meeting requests, tap **Menu > Tools > Options > Appointments** tab. Tap the **Send meeting requests via** box and choose to send via your Outlook E-mail, POP3/IMAP4 or Windows Live account.

- Notes**
- If you're sending the meeting request using your Outlook E-mail account, it will be sent to the attendees the next time you synchronize your XV6900 with your PC or Exchange Server.
  - When attendees accept your meeting request, the meeting is automatically added to their schedules. When their response is sent back to you, your calendar is updated as well.

## 6.3 Tasks

Use **Tasks** to keep track of things you need to do. A task can occur once or repeatedly (recurring). You can set reminders for your tasks and you can organize them using categories.

Your tasks are displayed in a task list. Overdue tasks are displayed in red.

### To create a task

1. Tap **Start > Programs > Tasks**.
2. Tap **Menu > New Task**, enter a subject for the task, and fill in information such as start and due dates, priority, and so on.
3. Specify the type of category for your task, so that it can be grouped with other related tasks. Tap **Categories**, then select a preset category (Business, Holiday, Personal, or Seasonal), or tap **New** to create your own category.
4. When finished, tap **OK**.

**Tip** You can easily create a short, to-do type task. Simply tap the **Tap here to add a new task** box, enter a subject, and tap the Enter button on the on-screen keyboard. If the task entry box is not available, tap **Menu > Options** and select the **Show Tasks entry bar** check box.

### To change the priority of a task

Before you can sort tasks by priority, you need to specify a priority level for each task.

1. Tap **Start > Programs > Tasks**.
2. Tap the task you want to change the priority for.
3. Tap **Edit**, and in the **Priority** box, tap a priority level.
4. Tap **OK** to return to the task list.

**Note** All new tasks are assigned a Normal priority by default.

### To set a default reminder for all new tasks

1. Tap **Start > Programs > Tasks**.
2. Tap **Menu > Options**.
3. Select the **Set reminders for new items** check box.
4. Tap **OK** to return to the task list.

**Note** The new tasks must have due dates set in order for the reminder to take effect.

### To show start and due dates in the task list

1. Tap **Start > Programs > Tasks**.
2. Tap **Menu > Options**.
3. Select the **Show start and due dates** check box.
4. Tap **OK**.

### To locate a task

When your list of tasks is long, you can display a subset of the tasks or sort the list to quickly find a specific task.

1. Tap **Start > Programs > Tasks**.
2. In the task list, do one of the following:
  - Sort the list. Tap **Menu > Sort By**, and tap a sort option.
  - Filter the list by category. Tap **Menu > Filter**, and tap the category you want displayed.

**Tip** To filter your tasks further, tap **Menu > Filter > Active Tasks** or **Completed Tasks**.

## 6.4 Notes

**Notes** helps you to quickly capture thoughts, questions, reminders, to-do lists, and meeting notes. You can create handwritten and typed notes, record voice notes, convert handwritten notes to text for easy readability, and send notes to others.

### To create a note

1. Tap **Start > Programs > Notes**. In the note list, tap **New**.
2. Tap the **Input Selector** arrow next to the **Input Method** icon on the menu bar, tap the input method you want, and enter your text.
3. If the **Input Selector** arrow is not displayed, tap the **Input Method** icon.
4. When finished, tap **OK** to return to the note list.

- Notes**
- To select handwritten text, tap and hold next to the writing. As soon as dots appear, and before they form a complete circle, quickly drag across the writing.
  - If a letter crosses three ruled lines, it is treated as a drawing rather than text.

### To draw in a note

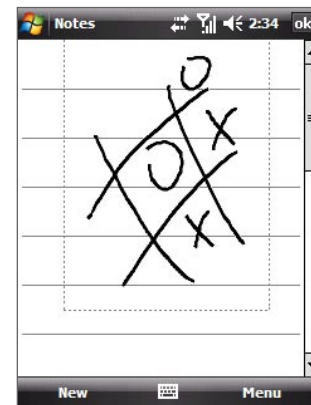

1. Tap **Start > Programs > Notes**.
2. In the note list, tap **New**.
3. To draw on the screen, use the stylus like a pen.
4. A selection box appears around your drawing.
5. When finished, tap **OK** to return to the note list.

- Note** To select a drawing (for example, to copy or delete it), tap and hold the drawing briefly. When you lift the stylus, the drawing is selected.



### To record a voice note

You can create a stand-alone recording (voice note) or you can add a recording to a note.

1. Tap **Start > Programs > Notes**.
2. Do one of the following:
  - To create a stand-alone recording, record from the note list.
  - To add a recording to a note, create or open a note.
3. If you do not see the Recording toolbar, tap **Menu > View Recording Toolbar**.
4. Tap the **Record** icon (  ) to begin recording your voice. Tap the **Stop** icon (  ) when finished recording.

### To change recording formats

1. Tap **Start > Settings > Personal tab > Input**.
2. Tap the **Options** tab, and select the desired format you want in the **Voice recording format** list.
3. Tap **OK**.

**Note** You can also change recording formats from within Notes. In the note list, tap **Menu > Options > Global Input Options** link (at the bottom of the page), then tap the **Options** tab.

## 6.5 Voice Recorder

**Voice Recorder** lets you record your voice and then quickly send it in an e-mail, beam it, or set the recorded voice as your ringtone.

**Note** Voice Recorder saves voice recordings in AMR-NB (Adaptive Multi-Rate Narrowband) format only. This is a common speech audio format used in mobile devices.

### To record your voice



1. Tap **Start > Programs > Voice Recorder**.
2. Hold the device's microphone near your mouth.
3. Tap **Record** or  to start recording a voice clip. Tap **Stop** to end the recording.

All recordings are saved in the **My Voices** folder by default. You can choose another folder to save voice recordings by tapping beside the folder name on the top-left of the screen and then in the menu, choose the folder where you would like to save future recordings.

### To play back a voice recording

- On the Voice Recorder screen, select a voice recording then tap .

**Tips**

- Tap  to increase the volume; tap  to decrease the volume.
- Tap  to toggle between muting and unmuting the volume.

### To send the voice recording via e-mail

- Select a voice recording then tap **Menu > Send > Outlook E-mail**. This creates a new Outlook e-mail message with the voice recording inserted as a file attachment. See "Using E-mail" in Chapter 7 to learn how to send e-mail.

### To beam the voice recording

1. Select the voice recording(s) you want to beam then tap **Menu > Beam File**.
2. Tap the device you want to send the voice recording(s) to.
3. On the other device, accept the file transfer to receive the file.

### To set the voice recording as a ring tone

- Select the desired voice recording then tap **Menu > Set as Ringtone**.

### To rename or move a recording

1. Select a voice recording then tap **Menu > Rename/Move**.
2. Enter the new **Name** for the voice recording.
3. To move the voice recording, select the new destination **Folder** and **Location**.
4. Tap **OK**.

# Chapter 7

## Exchanging Messages

**7.1 Messaging**

**7.2 Text Messages**

**7.3 MMS Messages**

**7.4 Setting Up E-mail Accounts**

**7.5 Using E-mail**

## 7.1 Messaging

**Messaging** is where your text messages (SMS) and e-mails are located. When you receive new messages, you can open them from the Today screen. Simply tap the type of message that you want to open.

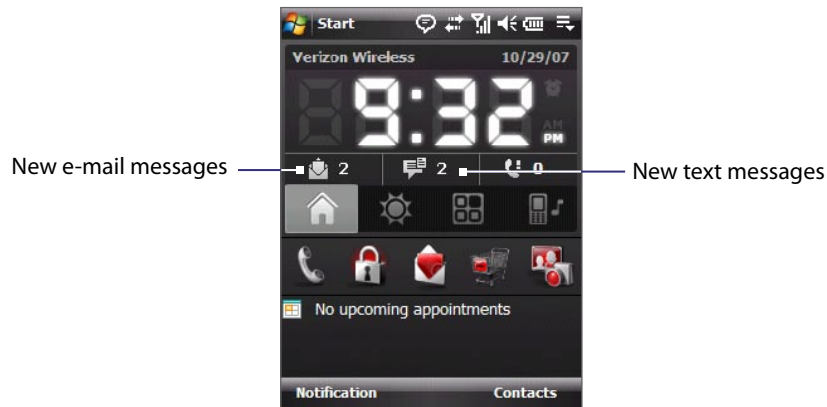

### To select a messaging account

- Tap **Start > Messaging**. The Account Picker screen then appears where you can select an account.
- While you are in a message list of a certain account, for example Text/Multimedia, tap **Menu > Go To** to switch to other types of messaging accounts.

### To configure message account settings

- Tap **Menu > Options** on the Account Picker screen; or
- Tap **Menu > Tools > Options** while you're in a message list.

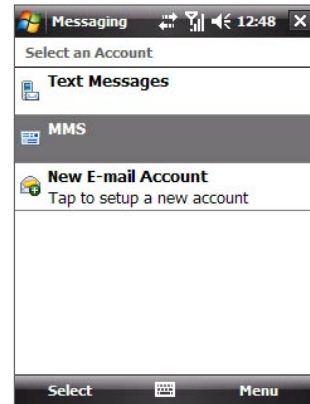

Account Picker screen

### To automatically add a signature in outgoing messages

You can automatically add your name and other information as your signature in outgoing SMS and e-mail messages by following these steps:

**Tip** You need to specify your signature for each type of messaging accounts.

1. Tap **Start > Messaging**, then tap **Menu > Options**.
2. Tap **Signatures**.
3. Select a type of messaging account in which to add a signature.
4. Select the **Use signature with this account** check box. In the provided text box, enter the information that will be displayed as your signature.
5. If you want the signature to be added whenever you reply or forward messages, select the **Use when replying and forwarding** check box.
6. Repeat steps 3 to 6 to add a signature to the other types of messaging accounts.



## 7.2 Text Messages

### Send text messages

#### To compose and send a text message

1. You can select a contact either from TouchFLO's Touch Cube or from Contacts.

##### Select a favorite contact from TouchFLO's Touch Cube:

- a. Open Touch Cube by sliding your finger upward, starting from the logo at the bottom of the touch screen. (See Chapter 1 for detailed instructions.)
- b. Slide your finger left or right to rotate the cube and navigate to the screen where it shows your favorite contacts.
- c. Touch and hold the photo or name of the favorite contact to whom you want to send a text message. The contact card of your selected contact is then displayed.

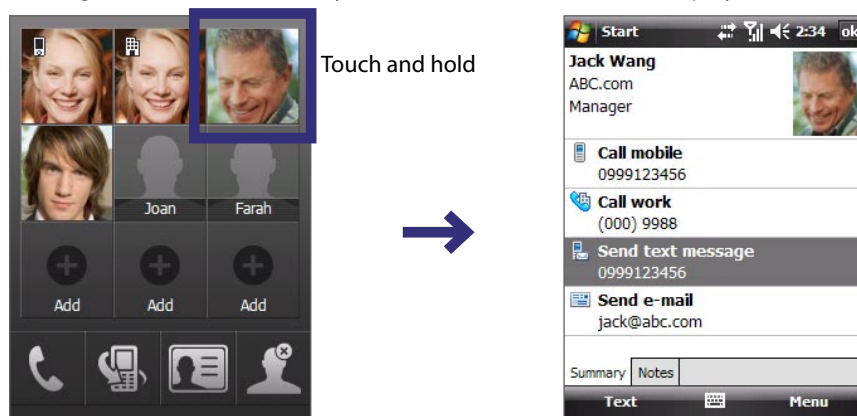

- d. Touch the item that shows **Send text message**.

##### Select from Contacts:

- a. Tap **Start > Contacts**.
  - b. Slide your finger upward on the touch screen to scroll down the contact list. See "Finger scrolling and finger panning" in Chapter 1 for more details on finger scrolling.
  - c. Touch the contact's name to open his or her contact card.
  - d. On the contact card, touch the item that shows **Send text message**.
2. A new text message is then created.

To add more recipients, enter their mobile phone numbers in the **To** field, separating them with a semicolon. You can also tap **To** if you want to add mobile phone numbers from Contacts.

3. Enter your message.
  - To quickly add common messages, tap **Menu > My Text** and tap a desired message.
  - To check the spelling, tap **Menu > Spell Check**.
4. Tap **Send**.

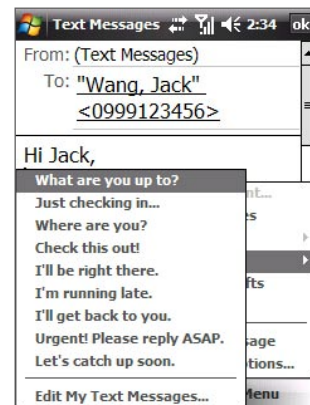

**Note** To enter symbols, tap **123** using the onscreen keyboard and then tap a symbol. For more information about entering text and symbols, see Chapter 2.

### To reply to or forward a text message

1. Select or open the message.
2. Tap **Reply**, or **Menu > Reply All**, or **Menu > Forward**.

### To automatically resend text messages that failed delivery

If text messages were not successfully sent due to network problem or loss of signal coverage, they will be queued in the **Text Messages Retry** program and automatically resent. While text messages remain queued, you can choose to delete some or all of them by following these steps:

1. Tap **Start > Programs > Text Messages Retry**.
2. Do one of the following:
  - To delete a text message, select the message then tap **Menu > Dismiss**.
  - To delete all queued text messages, tap **Menu > Dismiss All**.

## 7.3 MMS Messages

Creating and sharing multimedia messages (**MMS**) with your friends and family are easy with your device. You can attach pictures or video, and an audio clip in an MMS. You can even use the device camera to capture photos and video clips while composing a new MMS message, and send them along with your message.

### To access MMS

1. Tap **Start > Messaging**.
2. On the Account Picker screen, tap **MMS**.

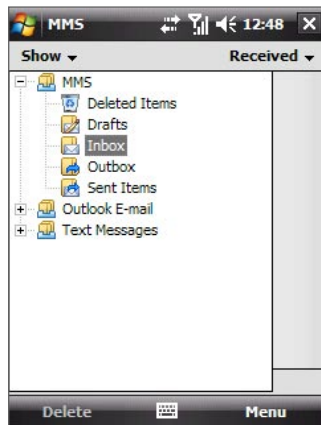

MMS message folders

- Notes**
- Please note that MMS is a charged service. In order to use MMS successfully, this has to be provisioned on your mobile account. Please contact Verizon Wireless to have this provisioned as part of your calling plan.
  - Please ensure the size of your MMS message is within the allowed limits when sending to another mobile phone user or sending to an e-mail address.

## Change MMS settings

When you send an MMS message, a notification (text message) will first be sent to the recipient, while your MMS message will be temporarily stored on an MMS server of your wireless service provider. When others send you an MMS message, similarly, the MMS message will be stored on the MMS server until you retrieve it. Hence, your device must be configured with the location of the MMS server for you to be able to send and receive MMS messages on your device.

When you purchase your device, it is already preset with Verizon's MMS server settings. If you accidentally lost the preset settings or you changed to another wireless service provider, follow the steps below to configure MMS settings.

### To configure MMS settings

1. Tap **Start > Messaging > MMS**.
2. Tap **Menu > MMS Configuration**. The MMS Configuration screen appears.
3. In the **Preferences** tab, select or clear the provided check boxes according to your needs. You can choose to retrieve MMS messages immediately, accept or reject messages, request a delivery receipt, specify a resolution for images you send, and more.
4. Tap the **Servers** tab and check if your device is preset with MMS server settings.

If there are no preset settings, tap **New** and enter the following information, which you can get from your wireless service provider.

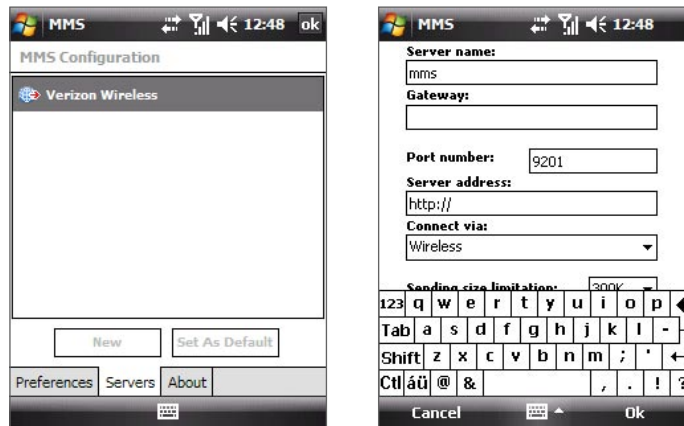

- **Server name.** A descriptive name, such as your wireless service provider name.
  - **Gateway.** Location of the MMS server, which is usually in the form of an IP address.
  - **Port number.** HTTP port number used for connecting to the MMS server and for file transfer.
  - **Server address.** URL address of the MMS server.
  - **Connect via.** Select the connection that your device uses for MMS.
  - **Sending size limitation.** Select the maximum MMS message size allowed by your wireless service provider.
  - **WAP version.** Select either **WAP 1.2** or **WAP 2.0**, depending on which one is being used by your wireless service provider.
5. Tap **OK**.

The MMS server settings will then be added as an entry on the MMS Configuration screen.

- Notes**
- If your device already has preset MMS settings, it is recommended that you do not change these settings. If you change the preset settings, your device may not be able to send and receive MMS messages.
  - If you add several MMS service providers to the MMS Configuration screen, you can choose one as your default MMS provider. Select the MMS provider's name in the list then tap **Set As Default**.

## Create and send MMS messages







After configuring the required settings, you can start to compose and send MMS messages.

### To compose an MMS message

You can compose MMS messages in a combination of various slides, where each slide can consist of an image or video clip, audio, and/or text.

1. On the MMS screen, do one of the following:
  - Tap **Menu > New > New Flix Message** to create an MMS message containing video and text, then skip to step 3.
  - Tap **Menu > New > New Pix Message** to create an MMS message containing images, audio, and text.
2. When you see the Choose a Media Message screen, tap a preset template, or tap **Custom** to open a blank MMS message.

**Note** If you prefer to always use a blank MMS message, select the **Always choose custom** check box.

3. In **To**, enter the recipient's phone number or e-mail address directly, or tap **To**, **Cc**, or **Bcc** to choose a phone number or an e-mail address from Contacts.
4. Enter a subject for your message.
5. Tap the **Insert** icon () to select and insert a photo, GIF animation, or video clip.
6. By default, My Documents will be displayed. Navigate folders by tapping the folder thumbnails. To return to an upper level folder, tap the Down arrow () and tap the folder name.
7. When selecting a photo, GIF animation, or video clip, you can:
  - Tap  to view it first, then tap  to insert the selected photo or video clip into the MMS message you are composing.
  - Tap  to take a photo and insert it into the MMS message.
  - Tap  to record an MMS video clip and insert it into the MMS message.
  - Tap  to quit selection and return to the MMS message.
8. Enter text. See "To add text to an MMS message" for details.
9. If you're composing a pix message, you can insert an audio clip. See "To add an audio clip to an MMS message" for details.
10. Tap **Send** to send the MMS message.

**Note** You can also send an MMS message directly from the Pictures & Videos or Camera program. Do one of the following:

- In Pictures & Videos, select a picture, GIF animation, or video, and tap **Menu > Send**. In **Select an account**, tap **MMS** if you're sending video, or tap **New Pix Message (MMS)** if you're sending an image or GIF animation.
- Capture a photo or an MMS video clip using the camera, and tap the **Send** icon. In the Send File dialog box, tap **Send via MMS**.

### To add text to an MMS message

When entering text into an MMS message, you can do the following:

- Tap inside the text box and enter your own text.
- Choose from common words or phrases. Tap  to add a text string from the Canned Text list.

**Tip** To edit or delete a phrase on the Canned Text list, tap and hold a string, then tap **Edit** or **Delete** from the shortcut menu. To create and add a new phrase to the list, tap **New**.









## To add an audio clip to an MMS message

You can add an audio clip to a pix message.

1. While composing a pix message, tap **Tap here to insert an audio clip**.

Open the folder that contains audio files. When navigating folders, tap the Down arrow (▼) to return to the upper folder.



2. Select an audio file. When selected, you can:

- Tap  to play the audio clip, tap  to pause, or tap  to stop playback.
- Tap  to insert it into your MMS message, or tap  to quit selection and return to your MMS message.
- To record a new audio clip and add it to your MMS message, tap  then tap  to start recording, and  to stop recording. The new audio clip is automatically inserted into your MMS message.

## To add slides

If you're composing a pix message, you can add more slides to your message by tapping **Edit > Insert Slide**.

While on a slide, you can:

- Tap  to preview the entire MMS message.
- Tap  to go to the previous slide, or tap  to go to the next slide.

## To customize the background color, text alignment and other options

While composing your MMS message, you can do the following:

- Tap **Options > Background** to choose a background color from the list.
- Tap **Options > Text on Top** to place text above the photo, GIF animation, or video.
- Tap **Options > Text Below** to place the text below the photo, GIF animation, or video.
- Tap **Options > Message Options** to specify the sending time, validity, priority, class, and other settings for a message.
- Tap **Edit > Attachments** to include a contacts card, calendar appointment, or any file as an attachment.



## To create an MMS message from a template

- While on an MMS message, tap **Edit > New from Template** to compose a message using a predefined template.

**Note** To save a message as a template, open the message and tap **Edit > Save as Template**.

## View and reply MMS messages

### To view an MMS message

- Use the playback controls , , and .
- Tap **Menu > Objects** to see a list of files included in the message. On the Message Objects screen, you can do the following:
  - To save a file, select it, and tap **Tools > Save**.
  - To use an audio file as a ring tone, tap **Tools > Set as Ringtone**.

### To reply to an MMS message

- Tap **Menu > Reply** to reply to the sender of the message, or tap **Menu > Reply All** to reply to all persons listed in To, Cc, and Bcc of the message.

## 7.4 Setting Up E-mail Accounts

### Types of E-mail Accounts

You can set up the following types of e-mail accounts on your device:

- Outlook e-mail that you sync with your PC or the Exchange Server.
- E-mail account that you have from an Internet Service Provider (ISP).
- Web-based e-mail accounts such as Yahoo!® Mail, AOL®, etc.
- Work account that you access using a VPN connection.

### Set up your device to synchronize Outlook e-mail with the computer

If you have installed the synchronization software on your PC and created a partnership with your device, then your device is ready to send and receive Outlook e-mail. If you have not yet installed the synchronization software nor created a partnership, please do so by following the procedures in Chapter 5.

**Tip** To set up your company e-mail account so that you can access Outlook e-mail messages wirelessly, you must set up your device to synchronize via the over-the-air connection with your company's Exchange Server. For more information about synchronizing with your company e-mail server, see Chapter 8.

### E-mail Setup Wizard

Windows Mobile's **E-mail Setup Wizard** lets you easily set up your personal and work e-mail accounts. You can add an e-mail account from an Internet Service Provider (ISP) or other e-mail provider as well as web-based accounts.

#### To set up a POP3 or IMAP4 e-mail account

Set up a POP3 or IMAP4 e-mail account on your device if you have an e-mail account from an Internet service provider (ISP) or other e-mail provider, or a Web-based account such as Gmail, Yahoo! Mail Plus, etc. You can also add a work account that you access using a VPN server connection as a POP3/IMAP4 account.

1. Tap **Start > Messaging > New E-mail Account**.
2. Enter your e-mail address, and select the **Try to get e-mail settings automatically from the Internet** check box. By selecting the option, the device attempts to download e-mail server settings so that you do not need to enter them manually. Tap **Next**.
3. After Auto Setup finishes, tap **Next**.

**Note** If Auto Setup is unsuccessful, select **Internet e-mail** from the **Your e-mail provider** list on the next screen. You will also be asked to enter e-mail server settings during the setup process. See "To specify e-mail server settings" for details.

4. Enter your name. You can also edit the **Account display name** field to specify the name of your ISP or e-mail provider. Tap **Next**.
5. Enter your login name if it does not show automatically in the **User name** field. Also enter your password, and select the **Save password** check box. Tap **Next**.
6. At this point, e-mail setup is complete. In the **Automatic Send/Receive** list, choose how frequent you want e-mail messages to be automatically sent and downloaded on your device.

**Note** Tap **Review all download settings** to select download options, set the e-mail format as HTML or plain text, and more. For more information, see "To customize download and format settings."

7. Tap **Finish**.

### To specify e-mail server settings

If Auto Setup is unsuccessful, contact your ISP or e-mail provider for the **Incoming mail server** and **outgoing mail server settings** so you can enter them on your device.

Other options that you can select include the following:

- Select the **Outgoing server requires authentication** check box, if required by your provider.
- If the outgoing e-mail server requires a different user name and password for sending e-mail, clear the **Use the same user name and password for sending e-mail** check box. You will be prompted to enter this information.
- Tap **Advanced Server Settings**, then select the **Require SSL** check box if your e-mail provider uses an SSL connection for more secured e-mail. From the **Network connection** list, select the data connection that you use for connecting to the Internet.

### To customize download and format settings

Before you tap **Finish** when setting up your POP3 or IMAP4 e-mail account, you can tap **Review all download settings** to choose download options, message format, and other settings.

Options	Description
<b>Automatic Send/Receive</b>	You can select a time interval for connecting to the Internet automatically to send and receive messages.
<b>Download messages</b>	Set the number of days of messages that you want to be downloaded to your device.
<b>Send/receive when I click Send</b>	By default, messages are immediately delivered when you tap <b>Send</b> . If you prefer to save outgoing messages to the Outbox folder first, clear the check box. (In this case, you will need to manually send messages by tapping <b>Menu &gt; Send/Receive</b> ).
<b>Use automatic send/receive schedule when roaming</b>	This allows your device to data roam when there is a set time interval for connecting to the Internet automatically. Since this may result in higher connection costs, you may want to leave the check box cleared.
<b>When deleting messages</b>	Choose whether to delete messages from the mail server when you delete them on your device.
<b>Message format</b>	Select HTML or Plain Text.
<b>Message download limit</b>	Select the e-mail download size. If you have large volumes of e-mail, use a lower size or select to download headers only.

## 7.5 Using E-mail

After setting up e-mail accounts on your device, you can start sending and receiving e-mail messages.

### Create and send messages

#### To compose and send a message

1. You can select a contact either from TouchFLO's Touch Cube or from Contacts.

##### Select a favorite contact from TouchFLO's Touch Cube:

- a. Open Touch Cube by sliding your finger upward, starting from the logo at the bottom of the touch screen. (See Chapter 1 for detailed instructions.)
- b. Slide your finger left or right to rotate the cube and navigate to the screen where it shows your favorite contacts.
- c. Touch and hold the photo or name of the favorite contact to whom you want to send an e-mail message. The contact card of your selected contact is then displayed.

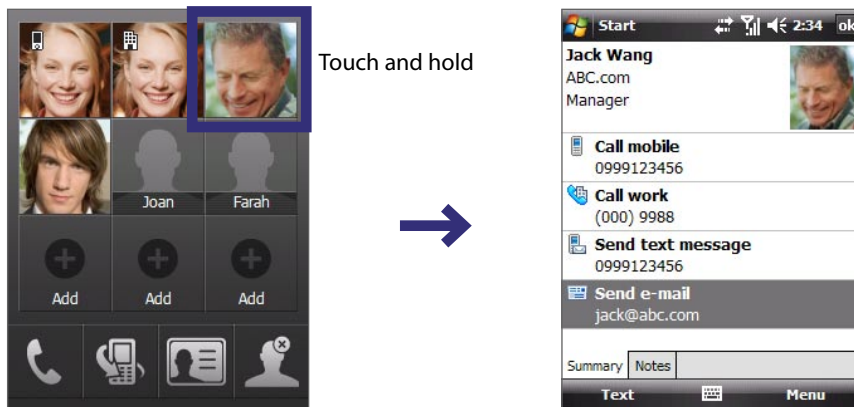

- d. Touch the item that shows **Send e-mail**.

##### Select from Contacts:

- a. Tap **Start > Contacts**.
  - b. Slide your finger upward on the touch screen to scroll down the contact list. See "Finger scrolling and finger panning" in Chapter 1 for more details on finger scrolling.
  - c. Touch the contact's name to open his or her contact card.
  - d. On the contact card, touch the item that shows **Send e-mail**.
2. If you have several e-mail accounts, the Account Picker screen will appear. Select an e-mail account that you want to use.
  3. A new e-mail message is then created.

To add more recipients, enter their e-mail addresses, separating them with a semicolon. You can also tap **To** if you want to add e-mail addresses stored in Contacts.

4. Enter a subject and compose your message. To quickly add common messages, tap **Menu > My Text** and tap a desired message.
5. To check the spelling, tap **Menu > Spell Check**.
6. Tap **Send**.

- Tips**
- To set the priority, tap **Menu > Message Options**.
  - If you are working offline, e-mail messages are moved to the Outbox folder and will be sent the next time you connect.



## To add an attachment to a message

1. In the message that you are composing, tap **Menu > Insert** and tap the item you want to attach: **Picture, Voice Note, or File**.
2. Select the file you want to attach, or record a voice note.

## Filter the Inbox message list

When the Inbox on your device is full of messages, it may be hard to browse and locate a desired message. You can filter your Inbox to only display the messages that contain a particular sender or subject you are searching for.

### To filter your Inbox

- Enter the sender name or e-mail subject you want to look for using the on-screen keyboard. As you tap keys, the message list narrows down to the conditions you have set.

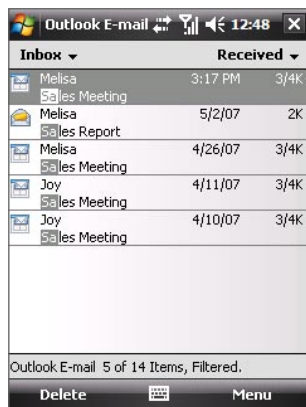

For example, tapping “S”, then “A” narrows the list to only the e-mails that contain sender names and e-mail subjects that start with “SA.”

## View and reply to messages

### To read an incoming message

By default, only the first few kilobytes of a message are shown when you open an incoming message. To read the whole message:

- Finger-scroll to the end of the message and tap **Get the rest of this message**; or
- Tap **Menu > Download Message**.

The message will be downloaded the next time you tap **Menu > Send/Receive** to send and receive e-mail.

**Note** If your company is running Microsoft Exchange Server 2007, the message downloads immediately, without waiting until the next time you synchronize. For more information about working with company e-mails, see Chapter 8.

### To download an attachment

An attachment appears below the subject of the message. Tapping the attachment opens the attachment if it has been fully downloaded or marks it for download the next time you send and receive e-mail.

- Notes**
- If there are multiple attachments in the message, all attachments are downloaded.
  - For information about setting your device to automatically download file attachments, see "Customize e-mail settings".
  - If your company is running Microsoft Exchange Server 2007, the attachment downloads immediately, without waiting until the next time you synchronize. For more information about working with company e-mails, see Chapter 8.

### To reply to or forward a message

1. Open the message and tap **Menu > Reply**, **Menu > Reply All**, or **Menu > Forward**.
2. Enter your response then tap **Send**.

**Tip** Whenever you reply to all the recipients of an Outlook e-mail, your own e-mail address will also be added to the recipient list. You can customize ActiveSync so that your e-mail address will be excluded. To do so, tap **Menu > Options** in ActiveSync, select the **E-mail** item, tap **Settings**, then tap **Advanced**. In the **My e-mail addresses** text box, enter your e-mail address.

### To view and reply to HTML e-mails

You can receive, view and reply to HTML e-mails from any type of e-mail account. The HTML format is retained, without layout shifting or resizing.

**Note** HTML e-mail support in Outlook Mobile is available only if your company is using Microsoft Exchange Server 2007.

1. Set the message format to HTML. To find out how to set the message format, see "Customize e-mail settings".
2. Tap **Start > Messaging**, select your e-mail account, and open an HTML e-mail that you received.
3. Tap the **Tap to scroll right** option to be able to scroll sideways and get a complete horizontal view of the message.
4. Tap **Get the rest of this message** that's shown at the bottom of the message to download and view the whole message.
5. If the e-mail does not download immediately, tap **Menu > Send/Receive**.
6. If images do not immediately appear on the message, tap **Internet pictures blocked** then tap **Download Internet pictures**.
7. Tap **Menu** and choose whether to reply or forward the message.
8. Enter your response then tap **Send**.

**Tip** E-mail can contain hyperlinks to Web pages.

## Download messages

The manner in which you download messages depends on the type of e-mail account you have.

### To send and receive e-mail for an Outlook account

1. Tap **Start > Programs > ActiveSync**.
2. Connect your device to your PC using the USB cable or Bluetooth.  
Otherwise, connect wirelessly if you are synchronizing Outlook e-mail with the Exchange Server. For more information, see Chapter 8.
3. Synchronization automatically begins, and your device sends and receives Outlook e-mail.

**Tip** You can also manually synchronize anytime by tapping **Sync** in ActiveSync or **Menu > Send/Receive** in Outlook Mobile.

### To send and receive e-mail for a POP3/IMAP4 account

If you have an e-mail account with an ISP or a work account that you access using a VPN server connection, you send and receive messages through a remote e-mail server. Before sending and downloading messages, you need to connect to the Internet or your corporate network.

1. Tap **Start > Messaging** and tap your POP3 or IMAP4 e-mail account.
2. Tap **Menu > Send/Receive**. Messages on your device and e-mail server are synchronized: new messages are downloaded to the device Inbox folder, messages in the Outbox folder are sent, and messages deleted from the server are removed from the device Inbox.

## Customize e-mail settings

### To change the download size and format for Outlook e-mail

1. Disconnect your device from the computer.
2. Tap **Start > Programs > ActiveSync**.
3. Tap **Menu > Options**, select **E-mail**, then tap **Settings**.
4. On the E-mail Sync Options screen:
  - Under **Download size limit**, select the desired e-mail size.
  - Under **Message format**, select HTML or Plain text.
5. Close ActiveSync and reconnect your device to the computer.

### To change the download size and format for POP3/IMAP4 e-mail

1. Tap **Menu > Options** on the Account Picker screen, or tap **Menu > Tools > Options** while you're in a message list.
2. Tap your e-mail account.
3. Keep tapping **Next** until you see **Message format** and **Message download limit** on the screen.
4. Under **Message format**, select HTML or Plain text.
5. Under **Download size limit**, select the desired e-mail size.
6. Tap **Finish**.

### To automatically receive attachments on Outlook e-mails

1. Tap **Start > ActiveSync**.
2. Tap **Menu > Options**.
3. Tap **E-mail > Settings**, then select **Include file attachments**.

### To automatically receive attachments on IMAP4 e-mails

1. Tap **Start > Messaging**.
2. Tap **Menu > Options**.
3. Tap the name of your IMAP4 account.
4. Keep tapping **Next** until you see the **Download attachments** item on the screen.
5. Select a download size from the **Download attachments smaller than** list box.
6. Tap **Finish**.

### To store attachments on a storage card

1. Tap **Start > Messaging**.
2. Tap **Menu > Tools > Options > Storage** tab.
3. Select the **Store attachments on storage card** check box.



# **Chapter 8**

## **Working With Company E-mail and Meeting Appointments**

**8.1 Synchronizing Your XV6900  
with the Exchange Server**

**8.2 Working With Company E-mail**

**8.3 Managing Meeting Requests**

**8.4 Finding Contacts in the Company Directory**

**8.5 E-mail Security**



## 8.1 Synchronizing Your XV6900 with the Exchange Server

To keep up-to-date with your company e-mail while you're out of the office, you can connect your XV6900 to the Internet wirelessly and synchronize it with your company's Exchange Server. You can also access your company address book anytime. Your company must have a mail server that is running Microsoft Exchange Server with Exchange ActiveSync.

### Set up an Exchange Server connection

Before you can synchronize or access information on the Exchange Server, you need to set up an Exchange Server connection on your XV6900. You need to get the following information from your network administrator and enter them on your XV6900:

- Exchange Server name (must be the Outlook Web Access server name)
- Domain name
- User name and password that you use at work

If you have not synchronized your XV6900 with your PC, follow these steps to set up an Exchange Server connection.

1. Tap **Start > Messaging > New E-mail Account**.
  2. Enter your e-mail address. Clear the **Try to get e-mail settings automatically from the Internet** check box, then tap **Next**.
  3. Select **Exchange server** in the **Your e-mail provider** list, then tap **Next**.
  4. Tap **Next** again.
  5. In **Server address**, enter the Exchange Server name, and tap **Next**.
  6. Enter your user name, password, and domain, and tap **Next**.
- Tip** To change the rules for resolving synchronization conflicts, tap **Advanced**.
7. Select the items that you want to sync with the Exchange Server.
  8. To change synchronization settings of an information type, for example, E-mail, select the type of information, and tap **Settings**.
  9. Tap **Finish**.

**Note** If you synchronized e-mails with your PC before, open ActiveSync on your XV6900 and tap **Menu > Add Server Source** to set up an Exchange Server connection. When you're prompted to select information types for synchronization, you need to clear the **E-mail** check box under the Windows PC item first before you can select **E-mail** under Exchange Server.

**Tip** To change Exchange Server settings, open ActiveSync then tap **Menu > Configure Server**.

### Start synchronization

Before you start synchronizing with the Exchange Server, make sure your XV6900 has been set up with a data connection to the Internet so that you can synchronize wirelessly. For more information about connections, see Chapter 10.

After you finish setting up an Exchange Server connection, your XV6900 automatically starts synchronization.

You can manually start synchronization anytime by tapping **Sync** in ActiveSync.

**Note** If you connect your XV6900 to your office computer via a USB or Bluetooth connection, you can use this connection to the PC to "pass through" to the network and download Outlook e-mails and other information to your XV6900.

## 8.2 Working With Company E-mail

Your XV6900 gives you instant access to your company e-mail and lets you manage your messages easier. Direct Push, Fetch Mail, Remote e-mail search, and e-mail flags are just some of the tools you can use to manage your e-mails.

**Note** Some messaging features depend on the Microsoft Exchange Server version used in your company. Please check with your network administrator for the availability of these features.

### Automatic synchronization through Direct Push

**Direct Push** technology (push e-mail feature) enables you to receive new e-mails on your XV6900 as soon as they arrive in your Inbox on the Exchange Server. With this feature, items such as contacts, calendar and tasks are also immediately updated onto your XV6900 when these items have been changed or new entries have been added on the Exchange Server. To make Direct Push work, you need to have a data connection on your XV6900.

You need to perform a full synchronization between your XV6900 and the Exchange Server first before Direct Push can be enabled.

**Requirement** The Direct Push feature works for the device only if your company is using **Microsoft Exchange Server 2003 Service Pack 2 (SP2) with Exchange ActiveSync or higher version.**

#### To enable Direct Push via Comm Manager

1. Tap **Start > Programs > Comm Manager** or tap **Start > Settings > Connections** tab > **Comm Manager**.
2. On the Comm Manager screen, tap the **DirectPush** button to enable or disable DirectPush.  
When enabled, the ON indicator is activated, which indicates that you will receive e-mails as they arrive. When disabled, you need to manually retrieve your e-mails.

#### To enable Direct Push via ActiveSync

1. In ActiveSync on your XV6900, tap **Menu > Schedule**.
2. Select **As items arrive** in the **Peak times** and **Off-peak times** boxes.

### Scheduled synchronization

If you do not want to use Direct Push, you can set a regular schedule for synchronizing Outlook e-mail and information.

1. In ActiveSync on your XV6900, tap **Menu > Schedule**.
2. Select a shorter time interval in the **Peak times** box for you to be able to receive e-mails more frequently. (Peak times which usually refer to your working hours when e-mail volume is high).
3. Select a longer interval in the **Off-peak times** box.

**Tip** To set the days and hours that make up your peak and off-peak times, tap **Adjust peak times to fit your schedule**.

## Instant download through Fetch Mail

The **Fetch Mail** feature downloads an entire e-mail immediately without the need for you to perform a full Send/Receive action. This limits the download to just the e-mail message that you want and helps save data cost.

**Requirement** Fetch Mail works for your XV6900 only if your company is using **Microsoft Exchange Server 2007 or higher**.

1. Tap **Start > Messaging > Outlook E-mail**.
2. Tap an e-mail message to open it.
3. By default, only the first few kilobytes of the message is shown. To download the whole e-mail, finger-scroll to the end of the message then tap **Get the rest of this message**.
4. A "Downloading message" status appears. Wait for the remainder of the message body to be downloaded.

**Tip** For information about changing e-mail sync options such as the initial download size limit for e-mail, see "Customize e-mail settings" in Chapter 7.

**Note** When you receive an e-mail that contains a link to a document such as a PDF or Microsoft Office document located on SharePoint or an internal file server, you can tap the link to view the document on the device. You can view the document only if you have a Microsoft Outlook account that synchronizes with Microsoft Exchange Server 2007 or later. Exchange Server must also be set up to allow access to SharePoint document libraries or internal file servers.

## Search for e-mails on the Exchange Server

You can access messages that are not available on your XV6900 by searching your Microsoft Exchange Server mailbox. The search results will be downloaded and displayed in a Search Results folder.

**Requirement** Your company must be using **Microsoft Exchange Server 2007 or higher**.

1. Tap **Start > Messaging > Outlook E-mail**.
2. Tap **Menu > Tools > Search Server**.
3. In the **Look for** text box, enter the search keyword.
4. Choose the date range of messages to search from.
5. From the **Look in** list, choose whether to search from your inbox or outbox only or to search all folders.
6. Tap **Search**.

## Flag your messages

Flags serve as a reminder for you to follow-up on important issues or requests contained in the e-mail messages. Flagging messages, which has been a useful feature on desktop Outlook E-mail, can also be done in Outlook Mobile on your XV6900. You can flag received e-mail messages on your XV6900.

**Requirement** Flags are enabled only if e-mails are synchronized with **Microsoft Exchange Server 2007 or higher**. Flags are disabled or hidden if e-mails are synchronized with earlier versions of Microsoft Exchange Server.



### To flag or unflag message

1. Tap **Start > Messaging > Outlook E-mail**.
2. Select a message or open a message.
3. Tap **Menu > Follow Up** and select one of the following options:
  - **Set Flag** Mark the message with a red flag to indicate that it needs follow up.
  - **Complete Flag** Mark the message with a check mark to indicate that the issue or request in the e-mail is already completed.
  - **Clear Flag** Remove the flag to unmark the message.

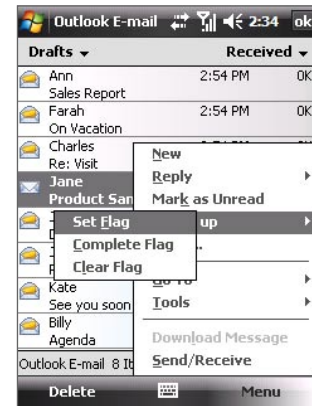

**Note** E-mail message reminders are displayed on your XV6900 if the messages are flagged with reminders and synchronized from the Exchange Server.

### Out-of-office auto-reply

Outlook Mobile allows you to retrieve and change your out-of-office status. Just like desktop Outlook E-mail, Outlook Mobile automatically sends an auto-reply message when you're not available.

#### To send out-of-office auto-reply messages

1. Tap **Start > Messaging > Outlook E-mail**.
2. Tap **Menu > Tools > Out of Office**.
3. From the **I am currently** list, select **Out of the Office**.
4. Enter your auto-reply message then tap **Done**.

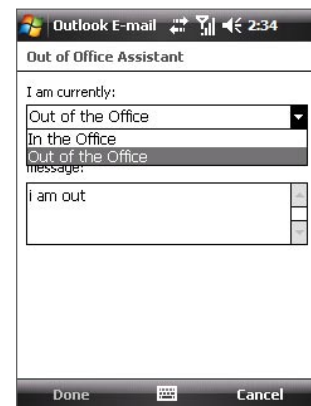

## 8.3 Managing Meeting Requests

When you schedule and send meeting requests from your XV6900, you can invite attendees to your meeting and check their status to know about their availability.

When you receive a meeting request, you can reply by accepting or declining the request. The meeting request also clearly indicates whether or not there are conflicting or adjacent meetings.

**Requirement** Your company must be using **Microsoft Exchange Server 2007 or higher**.

### To reply to a meeting request

1. When you receive a meeting request e-mail, a notification will be displayed on the Today screen. Open the e-mail.
2. Tap **Accept** to reply and accept the meeting request, or tap **Menu > Decline** if you cannot attend the meeting.

**Tips**

- Before responding, you can check your availability during the time of the requested meeting by tapping **View your calendar**.
- If the time of the meeting conflicts with your other appointments, a “Scheduling Conflict” status appears on top of the e-mail.

3. Choose whether or not to edit your response e-mail before sending then tap **OK**.

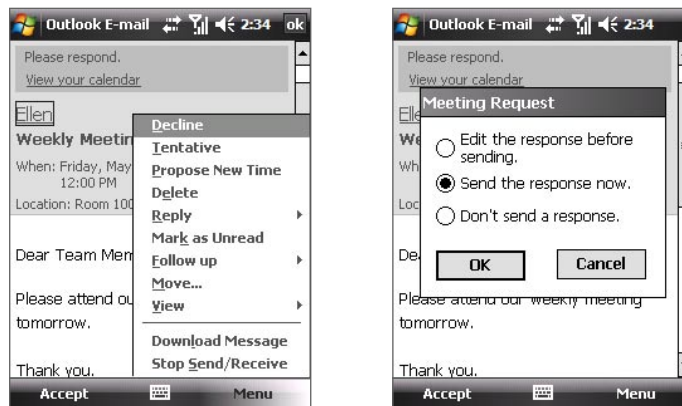

4. If you accepted the meeting request, it will automatically be added as an appointment in Calendar on your XV6900.

### To view the list of meeting participants

1. Tap **Start > Calendar**.
2. Tap a meeting request that you previously sent, then tap **Attendees**. The list of required and optional attendees will be listed.

**Notes**

- For information about creating a meeting request, see “To send a meeting request” in Chapter 6.
- If you select a meeting that you have organized, the list shows who has accepted or declined the meeting.
- To view an attendee’s contact information, tap the attendee’s name. If the attendee is included in your contacts list, you will see the contact information immediately. If the attendee is not in your contacts list, tap **Company Directory** to view the contact information.

## 8.4 Finding Contacts in the Company Directory

In addition to having contacts on the device, you can access contact information from your organization's Company Directory. By having over-the-air access to the Company Directory, you can easily send e-mail messages and meeting requests to anyone in your company.

**Requirement** Access to the Company Directory is available only if your organization is running Microsoft Exchange Server 2003 SP2 or higher, and you have completed your first synchronization with the Exchange Server.

1. Synchronize with Exchange Server if you have never done so.
2. Do any of the following:
  - In Contacts, tap **Menu > Company Directory**.
  - In a new e-mail message, tap the **To** box (or tap **Menu > Add Recipient**) then tap **Company Directory**.

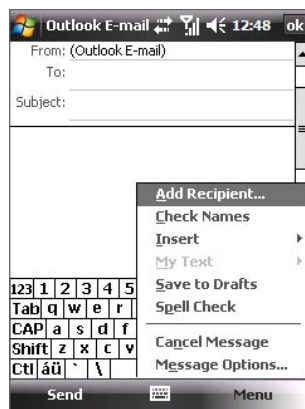

- In a new meeting request using Calendar, tap **Attendees** and then tap **Company Directory** at the top of the list.
3. Enter the part or full contact name and tap **Search**. In the search results list, tap a contact to select it.

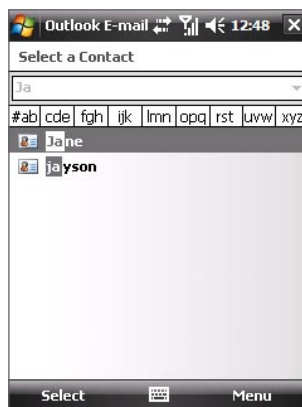

- Notes**
- You can save a contact from the Company Directory to your XV6900 by selecting the contact then tapping **Menu > Save to Contacts**.
  - You can search on the following information as long as that information is included in the Company Directory: First name, Last name, E-mail name, Display name, E-mail address, or Office location.

## 8.5 E-mail Security

Windows Mobile protects your Outlook e-mails through Secure/Multipurpose Internet Mail Extension (S/MIME), which allows you to digitally sign and encrypt your messages.

Digitally signing a message applies your certificate with the authorization key to the message. This proves to the recipient that the message is from you and not from an impostor or a hacker, and that the message has not been altered.

Encryption protects the privacy of your message by converting it from plain, readable text into cipher (scrambled) text. Only the recipient who has the authorization key can decipher the message.

**Requirement** S/MIME encryption and digital signatures for Windows Mobile-based devices are available only with **Exchange Server 2003 SP2 or a later version** that supports S/MIME. If your company is not using one of these products, or you have not completed your first synchronization with the Exchange Server, these options are unavailable.

**Note** You can encrypt a message with or without a certificate. However, to read an encrypted message, you need a valid certificate to decrypt it.

### To individually sign and encrypt a new message

1. Tap **Start > Messaging > Outlook E-mail**.
2. Tap **Menu > New** to create a new message.
3. Tap **Menu > Message Options**.
4. From the **Security** list, select whether to encrypt only, sign the message only, or do both.
5. Tap **OK**.

### To verify the digital signature on a signed message you receive

1. Open the Outlook e-mail message that has been digitally signed.
2. At the top of the message, tap **View Signature Status**.
3. Tap **Menu > Check Certificate**. To view the details of the certificate in the message, tap **Menu > View Certificate**.

**Note** There can be several reasons why a digital signature is not valid. For example, the sender's certificate may have expired, it may have been revoked by the certificate authority, or the server that verifies the certificate is unavailable. Contact the sender to report the problem.

### To digitally sign and encrypt all messages

You can set up ActiveSync to digitally sign and encrypt all outgoing messages. You must obtain a valid certificate to sign and encrypt e-mail messages successfully.

1. Tap **Start > Programs > ActiveSync**.
2. Tap **Menu > Options**.
3. Select the **E-mail** information type, and tap **Settings**. On the E-mail Sync Options screen, tap **Advanced**.

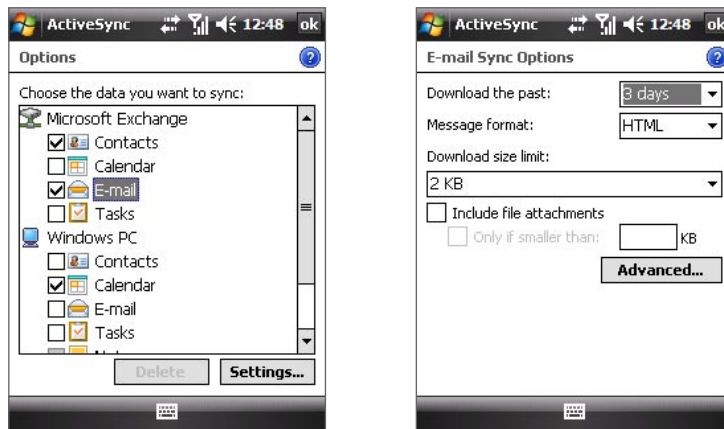

4. Do one or both of the following:

- To sign all your outgoing e-mail messages so that recipients can be certain that the messages were sent by you and have not been altered in any way, select the **Sign all outgoing e-mail messages** check box.
- To encrypt all your outgoing e-mail messages so that the contents of your messages are protected from being viewed by anyone other than the intended recipients, select the **Encrypt all outgoing e-mail messages** check box.

5. Tap **Choose Certificate** to select a certificate for signing or encrypting outgoing e-mail messages.

You can select certificates to sign or encrypt e-mail messages individually if you do not choose to sign or encrypt all outgoing e-mail. For information about signing and encrypting individual messages, see “To individually sign and encrypt a new message.”

## Set Permissions on an E-mail Message

Another way of protecting your e-mail messages is to send messages with restricted permissions using Information Rights Management (IRM).

**Note** This works only with a Microsoft Outlook e-mail account and if your company is using RMS Server SP1.

1. Tap **Start > Messaging > Outlook E-mail**.
2. Create a message, and then tap **Menu > Message Options**.
3. In **Permissions**, do one of the following:
  - To allow anyone to read the message, select **Unrestricted access**.
  - To prevent the message from being forwarded, printed, or copied, select **Do not forward**.
4. Tap **OK**.

**Tip** An IRM-protected message received on your XV6900 can only be replied to or forwarded if the message permits it.



# **Chapter 9**

## **Working With Documents and Files**

**9.1 Microsoft® Office Word Mobile**

**9.2 Microsoft® Office Excel® Mobile**

**9.3 Microsoft® Office PowerPoint® Mobile**

**9.4 Adobe Reader LE**

**9.5 Copying and Managing Files**

**9.6 ZIP**

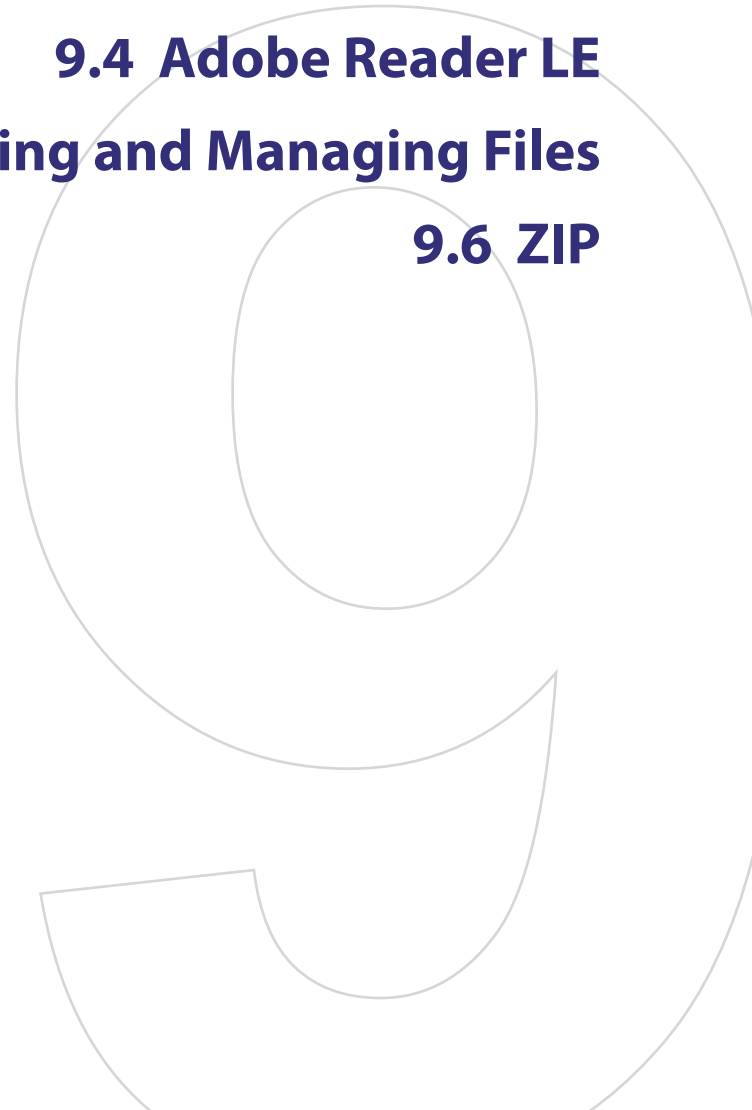

## 9.1 Microsoft® Office Word Mobile

**Microsoft® Office Word Mobile** is a streamlined version of Microsoft Word. Word documents created on your PC can be opened and edited on your XV6900. You can also create and edit documents and templates in Word Mobile and save them as **\*.doc**, **\*.rtf**, **\*.txt**, and **\*.dot** files.

You can have only one document open at a time. When you open a second document, the first one is saved and closed automatically.

### To create a Word file

1. Tap **Start > Office Mobile > Word Mobile**.
2. In Word Mobile, tap **New**. You will see either a blank document or template, depending on what you have selected as the default template.
3. Enter text as desired.
4. Tap **Menu**, and then choose whether to set the font, paragraph alignment and indentation, insert the date, do a spelling check, and more.
5. When you are finished, tap **OK** to save and close the file.

When you close a newly created document, it is automatically named after the first several words in the document and placed in the Word Mobile document list. You can easily rename the document and move it to another folder or a storage card.

## 9.2 Microsoft® Office Excel® Mobile

**Microsoft® Office Excel® Mobile** makes it easy for you to open and edit Excel workbooks and templates created on your PC. You can also create new workbooks and templates on your XV6900.

### To create an Excel file

1. Tap **Start > Office Mobile > Excel Mobile**.
2. In Excel Mobile, tap **New**. You'll see either a blank worksheet or template, depending on what you've selected as the default template.
3. Tap a cell to select it. Using the onscreen keyboard, enter your data and then tap the Enter key.
4. Tap **Menu**, and then choose whether to insert cells, charts, symbols or functions, format rows and columns, and more.
5. When you are finished, tap **OK** to save and close the file.

- Tips**
- Work in full-screen mode to see as much of your workbook as possible.
  - Tap **View > Zoom** and select a percentage so that you can easily read the worksheet.



## 9.3 Microsoft® Office PowerPoint® Mobile

With **Microsoft® Office PowerPoint® Mobile**, you can open and view slide show presentations created on your PC. Slide shows in **\*.ppt** and **\*.pps** format created using PowerPoint '97 and later can be viewed in PowerPoint Mobile.

Many presentation elements built into the slide shows such as slide transitions and animations will play back on the device. If the presentation is set up as a timed slide show, one slide will advance to the next automatically. Links to URLs are also supported.

Features not supported in PowerPoint Mobile include:

- **Notes.** Notes written for slides will not be visible.
- **Rearranging or editing slides.** PowerPoint Mobile is a viewer only.
- **Some file formats.** Files created in **\*.ppt** format earlier than PowerPoint '97 and HTML files in **\*.htm** and **\*.mht** formats are not supported.

### To start a slide show presentation

1. Tap **Start > Office Mobile > PowerPoint Mobile**.
2. In the presentation list, tap the slide show you want to view.
3. Tap the current slide to advance to the next slide.
4. To navigate between slides, tap **▲ | > Next** or **Previous**, or tap **Go to Slide** and tap the slide you want to view.

If the presentation is set up as a timed slide show, slides will advance automatically.

- Notes**
- If you have zoomed in to see a slide in more detail, you cannot navigate to another slide until you zoom out.
  - Tapping **Next** or **Previous** may play an animation on a slide rather than navigate to another slide.

### To stop a slide show

- In a PowerPoint Mobile presentation, tap **▲ | > End Show**.

## 9.4 Adobe Reader LE

**Adobe Reader LE** allows you to open and view Portable Document Format (PDF) files. These files usually have a **\*.pdf** file extension.

### To open a PDF file on your XV6900

1. Tap **Start > Programs > Adobe Reader LE**.
2. Tap **Open**.
3. Browse to a folder and tap the PDF file you want to view.

**Note** To open another PDF file, tap **Menu > Open**. Tap **Browse**, select the desired file, and tap **Open**. You can also open a PDF file from File Explorer.

### To navigate through a PDF file

You can do any of the following:

- Tap the Up, Down, Right, and Left arrow keys on the horizontal and vertical scrollbars to move to the desired direction of the page.
- Press NAVIGATION up, down, right, and left to move up or down a page or scroll through the pages.

- Tap the space between the arrow keys and the scrollbar with your stylus to move one screen towards the desired position.
- Tap and drag the scrollbar tab to quickly scroll through pages and jump to a desired page number.
- Tap **Tools > Go To** and select an option to go to a specific page in a multi-page PDF file.

### To enlarge or reduce the display size

1. Open a PDF file you want to view.
2. Tap **Tools > Zoom**.
3. Select **In** or **Out** to enlarge or reduce the display size. Otherwise, select **Fit Screen** or **Fit Width**.
4. Select **To %** to set an arbitrary zoom ratio.

### To customize page view and orientation

1. Open a PDF file you want to view.
2. Tap **Tools > View**.
3. Select an option to suit your view.

### To find text in a PDF file









1. Open a PDF file you want to view.
2. Tap **Tools > Find > Text**.
3. Enter the text to be searched.
4. Choose search parameters, such as Match case, Whole word, Backwards, and tap **Find**.

**Note** Adobe Reader LE offers you the following advance features.

- It displays a bookmark pane for the PDF files that contain bookmarks. Tap the bookmarks to go to a specific section/page within the file.
- It supports password-protected PDF files with up to 128-bit encryption. When you open a password-protected PDF file, you will be prompted to enter the password before the file can be opened.

### To use the toolbar

You can also use the Adobe Reader LE toolbar to access the most commonly used functions. The following table lists the toolbar controls.

This Control	Does This
	Fit the entire page to the screen
	Fit the page width to the screen
	Display the first page
	Display the previous page
	Display the next page
	Display the last page
	Display the text search screen
	Zoom in/out

## 9.5 Copying and Managing Files

You can copy files between your XV6900 and PC using Windows Mobile Device Center or ActiveSync, or copy files to a storage card that is inserted on the device. You can also efficiently manage your files and folders using File Explorer.

### Copy files using Windows Mobile Device Center or ActiveSync

Using Windows Mobile Device Center or ActiveSync, you can copy files from your PC to your XV6900 and vice versa.

#### To copy a file between your XV6900 and the PC

1. Connect your XV6900 to the PC.
2. Click **File Management > Browse** in Windows Mobile Device Center or click **Explore** in ActiveSync on your PC. This opens the Mobile Device folder for your XV6900.
3. Browse your XV6900 for files that you want to copy to your PC.
4. To copy a file from your XV6900 to your PC:
  - a. In the Mobile Device folder, go to the file that you want to copy.
  - b. Right-click the file, then click **Copy**.
  - c. Locate the destination folder on your PC. Right-click the folder, then click **Paste**.
5. To copy a file from your PC to your XV6900:
  - a. On your PC, navigate to the folder that contains the file you want to copy.
  - b. Right-click the file, then click **Copy**.
  - c. Right-click the destination folder under Mobile Device, then click **Paste**.

Copying a file results in separate versions of a file on your XV6900 and PC. Because the files are not synchronized, changes made to one file will not affect the other. If you want to file changes to be automatically updated on your XV6900 and PC, you can synchronize files between your XV6900 and PC. For more information about synchronizing with a computer, see Chapter 5.

### Use File Explorer

**File Explorer** lets you browse the contents of folders on the device. The root folder on the device is named My Device. My Device is similar to My Computer on the PC and contains the My Documents, Program Files, Temp, Storage Card, and Windows folders, among others.

#### To use File Explorer

1. Tap **Start > Programs > File Explorer**.
2. Tap a folder or file to open it.
3. To return to an upper level folder, tap the Down arrow (▼) and select the folder.
4. To delete, rename, or copy a file quickly, tap and hold the file then choose the desired operation from the shortcut menu. To select multiple files, tap and drag over the desired files.

## Store files to a storage card

### To copy files to a storage card

1. Make sure the storage card is properly inserted into the device.
2. Tap **Start > Programs > File Explorer** and navigate to the appropriate folder.
3. Tap and hold the file you want to copy, and tap **Copy**.
4. Tap the folder list (labeled **My Documents** by default) and tap **Storage Card**.
5. Tap **Menu > Edit > Paste**.

### To automatically save files on a storage card

In the Word Mobile, Excel Mobile, and Notes programs, you may find it helpful to save all new documents, notes, and workbooks directly on a storage card.

1. From the program file list, tap **Menu > Options**.
2. With a storage card inserted in your XV6900, in the **Save to** box, select the appropriate storage card to automatically save new files on the storage card.
3. Tap **OK**.

**Note** In the file or note list, a storage card symbol () is displayed next to the names of files saved on a storage card.

## 9.6 ZIP

This feature allows you to save memory and increase the storage capacity of the device by compressing files in the conventional ZIP format. You can view and extract archive files received from various sources. You can also create new \*.zip files on your XV6900.

### Start ZIP and Open .zip files

You can use **ZIP** to either archive files or open an existing archive file on the device. Each time you start ZIP on the device, it searches for files that have the .zip file extension, and displays these files on the Archive List screen.

#### To start ZIP on your XV6900

- Tap **Start > Programs > Zip**.

#### To open a ZIP file and extract files

1. Open a file using any of the following:
  - Select a file and tap **File > Open Archive**.
  - Tap and hold a file and tap **Open Archive**.
  - Double-tap a file.

**Note** You cannot select multiple ZIP files.

2. The files contained in the zip file are then displayed. Select files by doing one of the following:
  - Tap to select a file.
  - To select several files, tap **Menu > Action** and make sure **Multi-Select Mode** is selected. Select files by tapping each file. (Tap a selected file to deselect it.)
  - To select all files, tap **Menu > Action > Select All**.

3. Tap **Menu > Action > Extract**.
4. Choose a folder in which files will be extracted to, then tap **Extract**.

### To create a zip archive

1. Tap **New** or **File > New Archive**.
2. On the Save As screen, enter a zip file name and choose a folder in which to save the zip file. You can also choose whether the zip file will be saved on the device's main memory or a storage card.
3. Tap **Save**.
4. Tap **Menu > Action > Add**.
5. Double-tap the folder that contains the files you want to archive.
6. Select files by doing one of the following:
  - Tap to select a file.
  - To select several files, tap and hold on the screen, then select **Multi-Select Mode**. Select files by tapping each file. (Tap a selected file to deselect it.)
  - To select all files, tap and hold on the screen, then tap **Select All**.
7. Tap **Add**.
8. Tap **Menu > File > Close Archive**.
9. After closing the zip file, you can tap **Find** or **Menu > File > Find Archive** to search for all zip files and display them on the Archive List screen.



# Chapter 10

## Getting Connected

**10.1 Comm Manager**

**10.2 Connecting to the Internet**

**10.3 Internet Explorer® Mobile**

**10.4 Bluetooth**

**10.5 Using Your XV6900 As a Modem  
(BroadbandAccess Connect)**

## 10.1 Comm Manager

**Comm Manager** acts like a central switch that lets you enable or disable phone features as well as manage the connections of your XV6900 easily.

### To open Comm Manager

- Tap **Start > Programs > Comm Manager** or tap **Start > Settings > Connections tab > Comm Manager**.

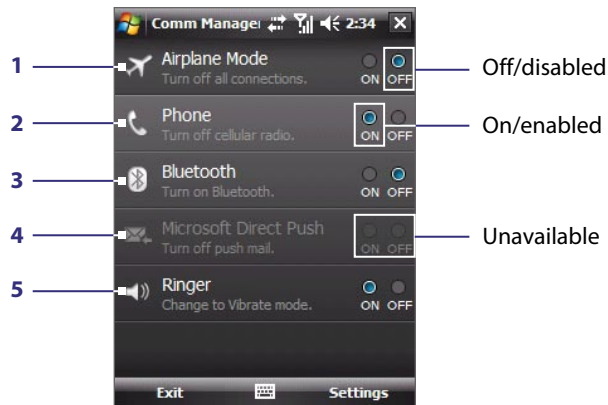

- 1 Tap to switch Airplane mode on or off. Turning on Airplane mode turns off the phone and Bluetooth functions. For more information, see “Airplane Mode” in Chapter 3.
- 2 Tap to switch the phone on or off. Tap **Settings > Phone** to set the ring tone and other phone settings. See Chapter 4 for details.
- 3 Tap to switch Bluetooth on or off. Tap **Settings > Bluetooth** to configure Bluetooth on your XV6900. See “Bluetooth” in this chapter for details.
- 4 Tap to switch between automatically receiving (as items arrive) or manually retrieving Outlook e-mails. See Chapter 8 for details.
- 5 Tap to toggle between turning on the phone’s ringer or setting the phone to vibration mode.

## 10.2 Connecting to the Internet

### Dial-up connection

Your device’s networking capability allows you to access the Internet through the dial-up connection. Settings for connecting to your service provider’s 1xRTT/EVDO network are already preconfigured on your device, and your device is ready to connect to the Internet. Please do not change these settings as this may cause your data connection to stop working.

If you need to use another dial-up connection from an ISP (Internet Service Provider), you can manually add it to your device. To establish a dial-up connection on your device, you need the same settings that you normally use when you dial up from your computer. This includes the ISP server phone number, your user name and password.

1. Tap **Start > Settings > Connections tab > Connections**.
2. Under **Verizon Wireless**, tap **Add a new modem connection**.



3. On the Make New Connection screen, enter a name for the connection.
4. In the **Select a modem** list, select **Cellular Line**, then tap **Next**.
5. Enter the ISP server phone number, then tap **Next**.
6. Enter your user name, password, and any other information required by your ISP.
7. Tap **Finish**.

- Tips**
- To view help information for any screen, tap the **Help** icon (  ) on the Connections screen.
  - To modify your connection settings, tap **Manage existing connections** on the Connections screen, and complete the connection wizard.

## Work network connection

A Virtual Private Network (VPN) connection allows you to access your company network through your device's Internet connection. A proxy connection lets you access the Internet using an existing connection to your corporate or WAP network.

1. Obtain the following information from your network administrator:
  - Server phone number
  - User name and password
  - Domain (and other required settings, such as IP address)
2. Tap **Start > Settings > Connections** tab > **Connections**.
3. In **My Work Network**, follow the instructions for each type of connection.
4. Complete the connection wizard, then tap **Finish**.

## Start a data connection

After setting up a data connection such as the ISP dial-up on your device, you can now connect your device to the Internet. The connection is started automatically when you begin using a program that accesses the Internet such as Internet Explorer® Mobile.

### To manually start a data connection

If you have set up multiple types of data connections on your device, you can manually start a connection.

1. Tap **Start > Settings > Connections** tab > **Connections**.
2. Tap **Manage existing connections**.
3. Tap and hold the name of the desired connection, then tap **Connect**.

### To disconnect a data connection

- Press and hold the END button until the Quick List appears, and then tap **Terminate data connection** to end the connection.

## 10.3 Internet Explorer® Mobile

**Internet Explorer Mobile** is a full-featured Internet browser, optimized for use on your device.

### To start Internet Explorer Mobile

- Tap **Start > Internet Explorer**.

### To set a Home page

1. In the address bar on top of the Internet Explorer Mobile screen, enter the desired Web page address. Tap  to open the Web page.
2. Tap **Menu > Tools > Options > General** tab.
3. Do one of the following:
  - To use the displayed page as the Home page, tap **Use Current**.
  - To use the default Home page, tap **Use Default**.

**Tip** To go to your Home page, tap **Menu > Home**.

### To transfer favorites from your PC

You can transfer the favorites you have stored on your PC to your device by synchronizing the Internet Explorer favorites on your PC with your device.

1. In ActiveSync on your PC, on the **Tools** menu, click **Options**, and select **Favorites**.
2. In Internet Explorer on your PC, click **Favorites > Add to Favorites** and save or move favorite links to the Mobile Favorites subfolder in the Favorites list.
3. Connect your device to your PC. If synchronization does not start automatically, click **Sync**.

### To add a favorite

1. In Internet Explorer Mobile, go to the page you want to add.
2. Tap and hold the page, and tap **Add to Favorites**.
3. Confirm or change the name, and select a folder for storing the favorite.
4. Tap **Add**.

### To delete a favorite or folder

1. In Internet Explorer Mobile, tap **Menu > Favorites > Add/Delete** tab.
2. Select the item you want to delete, and tap **Delete**.

### To change the size of text on Web pages

- In Internet Explorer Mobile, tap **Menu > Zoom**, and tap the size you want.

### To change how Web pages fill the screen

1. In Internet Explorer Mobile, tap **Menu > View**.
2. Tap one of the following:
  - **One Column.** Arranges the content into one column that is as wide as the screen. This means that you will rarely have to scroll horizontally.
  - **Default.** Maintains a layout similar to what you see on a desktop computer, but it makes items smaller and arranges the content so that you can see most of it without having to scroll horizontally.
  - **Desktop.** Keeps the same layout and size as on a desktop computer, which will require both horizontal and vertical scrolling.

### To clear the History list

1. In Internet Explorer Mobile, tap **Menu > Tools > Options > Memory** tab.
2. Tap **Clear History**.

### To save a picture from a Web page

1. In Internet Explorer Mobile, tap and hold the picture, and tap **Save Image**.
2. Do one of the following:
  - To save the picture in **My Pictures** on your device, tap **Yes**.
  - To save the picture in another location, such as a storage card, tap **Save As**.

### To delete temporary Internet files

Your device temporarily stores Web pages that you frequently visit or have visited recently to speed up the display of these Web pages when you access them. You may want to delete these files to free storage space.

1. In Internet Explorer Mobile, tap **Menu > Tools > Options > Memory** tab.
2. Tap **Delete Files**. All pages stored on your device, including offline favorites content, will be deleted.

### To set up Internet security settings

Cookies are small files containing information about your identity and preferences so that a page can tailor information to your needs. The page sends the file, and it is stored on your device.

1. In Internet Explorer Mobile, tap **Menu > Tools > Options > Security** tab.
2. To prevent Internet Explorer Mobile from accepting any cookies, clear the **Allow cookies** check box.
3. Select the check boxes for the other security options you want, and tap **OK**.

## 10.4 Bluetooth

Bluetooth is a short-range wireless communications technology. Devices with Bluetooth capabilities can exchange information over a distance of about eight meters without requiring a physical connection.

### Bluetooth modes

Bluetooth on your device operates in three different modes:

- **On.** Bluetooth is turned on. Your device can detect other Bluetooth-enabled devices, but not vice versa.
- **Off.** Bluetooth is turned off. In this mode, you can neither send nor receive information using Bluetooth. Turn off Bluetooth when not in use to conserve battery power, or in places where using a wireless device is prohibited, such as on board an aircraft and in hospitals.
- **Visible.** Bluetooth is turned on, and all other Bluetooth-enabled devices can detect your device.

**Note** By default, Bluetooth is turned off. If you turn it on, then turn off your device, Bluetooth also turns off. When you turn on your device again, Bluetooth automatically turns on.

### To turn Bluetooth on and make your device visible

1. On your device, tap **Start > Settings > Connections tab > Bluetooth > Mode** tab.
2. Select the **Turn on Bluetooth** and **Make this device visible to other devices** check boxes.
3. Tap **OK**.

### Bluetooth partnerships

A Bluetooth partnership is a relationship that you create between your device and another Bluetooth-enabled device in order to exchange information in a secure manner.

### To create a Bluetooth partnership

1. On your device, tap **Start > Settings > Connections tab > Bluetooth**.
2. On the **Devices** tab, tap **Add new device**. Your device searches for other Bluetooth devices and displays them in the box.
3. Tap the desired device name in the box, then tap **Next**.
4. Specify a passcode to establish a secure connection. The passcode can be 1 up to 16 characters.
5. Tap **Next**.
6. Wait for the paired device to accept the partnership. The receiving party needs to enter the same passcode that you specified.
7. The name of the paired device is then displayed. You may edit and enter a new name for that device.
8. Select the check boxes of services that you want to use from the paired device.
9. Tap **Finish**.

**Note** Creating a Bluetooth partnership between two devices is a one-time process. Once a partnership is created, the devices can recognize the partnership and exchange information without entering a passcode again.

### To accept a Bluetooth partnership

1. Ensure that Bluetooth is turned on and in visible mode.
2. Tap **Yes** when prompted to establish a partnership with the other device.
3. Enter a passcode (the same passcode that is entered on the device requesting the partnership) to establish a secure connection. The passcode must be between 1 and 16 characters.

4. Tap **Next**.
5. Tap **Finish**. You can now exchange information with the paired device.

- Tips**
- To rename a Bluetooth partnership, tap and hold the partnership's name on the **Devices** tab of the Bluetooth Settings screen, then tap **Edit**.
  - To delete a Bluetooth partnership, tap and hold the partnership's name on the **Devices** tab, then tap **Delete**.

## Connect a Bluetooth hands-free or stereo headset

For hands-free phone conversations, you can use a Bluetooth hands-free headset such as a car kit with your device. Your device also supports A2DP (Advanced Audio Distribution Profile) which allows you to use a Bluetooth stereo headset for hands-free phone conversations and for listening to stereo music.

### To connect a Bluetooth hands-free or stereo headset

1. Make sure that both your device and the Bluetooth headset are turned on and within close range, and that the headset is visible. Refer to the manufacturer's documentation to find out how to set the headset in visible mode.
2. Tap **Start > Settings > Connections** tab.
3. Tap **Bluetooth > Devices** tab > **Add new device**. Your device searches for other Bluetooth-enabled devices and displays them.
4. Tap the name of the Bluetooth headset, then tap **Next**.
5. Enter the passcode of the Bluetooth headset, then tap **Next**.
6. Make sure the **Hands Free** check box is selected. If you have a Bluetooth stereo headset, also make sure **Wireless Stereo** is selected.
7. Tap **Finish**.

While the Bluetooth stereo headset is connected, the **Headset** icon (📞) will appear on the title bar.

- Note** If the Bluetooth stereo headset becomes disconnected, turn the headset on and repeat steps 1 to 3 above. Tap and hold the name of the Bluetooth stereo headset and tap **Set as Wireless Stereo**.



## Beam information using Bluetooth

You can beam information, such as contacts, calendar items, and tasks, as well as files from your device to your computer or to another Bluetooth-enabled device.

- Note** If your computer does not have built-in Bluetooth capability, you need to connect and use a Bluetooth adapter or dongle on your computer.

### To beam information from your device to a computer

1. Turn on Bluetooth on your device, and make your device visible. For information about this, see "To turn Bluetooth on and make your device visible".
2. Next, set Bluetooth on your computer to visible mode, create a Bluetooth partnership, then enable your computer to receive Bluetooth beams.

If your computer has **Windows Vista or Windows XP SP2** and your computer's Bluetooth adapter is supported by your Windows version, take the following steps:

- a. On your computer, open **Bluetooth Devices** from the Control Panel then click the **Options** tab.
- b. For **Windows Vista**, select **Allow Bluetooth devices to find this computer**.  
For **Windows XP**, select **Turn discovery on** and **Allow Bluetooth devices to connect to this computer**.

- c. Create a Bluetooth partnership between your device and computer. For information about creating a partnership, see “Bluetooth partnerships”.
  - d. In the **Options** tab of **Bluetooth Devices**, select **Show the Bluetooth icon in the notification area**.
  - e. To enable your computer to receive Bluetooth beams, right-click the Bluetooth icon at the bottom-right of your computer screen and select **Receive a File**.
3. Now you are ready to beam. On your device, select an item to beam. The item can be an appointment in your calendar, a task, a contact card, or a file.
  4. To beam a contact, tap **Menu > Send Contact > Beam**.  
To beam other types of information, tap **Menu > Beam [type of item]**.
  5. Tap the device name to which you want to send the beam.
  6. If you beamed a calendar, task, or contact item to your computer and it is not automatically added to Outlook, select **File > Import and Export** in Outlook to import it.

To beam information to a Bluetooth-enabled device such as another Windows Mobile powered device, follow steps 1 to 5 in the above procedure.

- Tips**
- The default folder on your computer where beamed items are stored may be C:\Documents and Settings\your\_username\My Documents in Windows XP or C:\Users\your\_username\My Documents in Windows Vista.
  - For your device to receive Bluetooth beams, tap **Start > Settings > Connections** tab > **Beam** and make sure the **Receive all incoming beams** check box is selected.

## Bluetooth Explorer and Bluetooth file sharing

**Bluetooth Explorer** searches for other Bluetooth devices that have file sharing enabled and lets you access their Bluetooth shared folder. You can copy files from and to their shared folder, and create subfolders in it. When you enable **Bluetooth file sharing** on your device, other Bluetooth-enabled devices will also be able to access your Bluetooth shared folder.

### To enable Bluetooth Explorer and Bluetooth file sharing on your device

1. Tap **Start > Settings > Connections** tab > **Bluetooth > FTP** tab.
2. Select the **Enable Bluetooth Explorer** check box. This makes the **\Bluetooth** device folder visible in the File Explorer.
3. Select the **Enable File Sharing** check box.

You can use the default Bluetooth shared folder, or tap **Browse** to use another folder as your shared folder.

- Note** To use the Bluetooth file sharing feature on your device, tap **Start > Settings > Connections** tab > **Beam** and make sure the **Receive all incoming beams** check box is selected. If you disable the **Receive all incoming beams** option, the **Enable File Sharing** feature will be disabled automatically.

### To use Bluetooth Explorer

1. Bluetooth Explorer is integrated with the File Explorer program. You can open it by tapping **Start > Programs > Bluetooth Explorer** or by tapping Down arrow (▼) on the upper left of File Explorer then tapping **Bluetooth**.
2. Bluetooth Explorer then scans for other Bluetooth devices that have file sharing enabled. From the list, tap to select a Bluetooth device you want to connect to. You may need to enter a passcode in order for you to connect to the selected device.

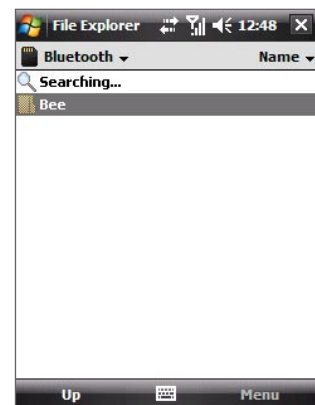

3. If there are files contained in the Bluetooth shared folder on the other device, you will be able to see them on the Bluetooth Explorer screen. Select one or more files, then tap **Menu > Edit** and choose to cut or copy the files.
4. Tap **Up** twice.
5. Navigate to the folder where you want to paste the files on your device, then tap **Menu > Edit > Paste**.

## 10.5 Using Your XV6900 As a Modem (BroadbandAccess Connect)

When you need Internet access on your notebook computer while traveling, you can use your XV6900 as a modem for your notebook. Install the VZAccess Manager software from the provided CD onto your notebook so you can use the NationalAccess or BroadbandAccess service from Verizon Wireless to connect your notebook to the Internet.

This section shows how to install VZAccess Manager and quickly set up your notebook computer for Internet access. You will also learn the basics on using VZAccess Manager, such as how to connect to the NationalAccess or BroadbandAccess service, use its text messaging feature, etc. For more in-depth information about this software, refer to the documentation on the CD.

- Notes**
- Your data plan must include the NationalAccess or Broadband Access service. Contact Verizon Wireless or visit <http://www.verizonwireless.com> to get pricing information and subscribe to any of these services.
  - The VZAccess Manager software on the provided CD has been customized for XV6900. Some features described in the documentation on the CD may not be supported.

### Install VZAccess Manager

There are two items that you need to install to your notebook computer: XV6900's modem driver and VZAccess Manager software. Follow the steps below to complete the installation.

#### To install XV6900's modem driver

1. Insert the provided CD into the CD or DVD drive of your notebook computer.
2. Run **Start.exe** from the CD.
3. On the first window that opens, click **Next**.
4. The main installation window then appears. Click **Install USB Driver**.



5. On the Welcome screen, click **Next**. The installer then copies XV6900's modem driver to your computer.
6. Select **Yes, I want to restart my computer now**, click **OK**, and then click **Finish**.

After restarting your computer, run the installer again and install the VZAccess Manager software.

## To install VZAccess Manager

1. Run **Start.exe** from the CD.
2. Click **Next**.
3. Click **Install VZAccess Manager** and follow the on-screen instructions to complete the installation.

## Set Up Internet access

After installation is complete, the VZAccess Manager Setup Wizard automatically opens and walks you through the process of setting up your notebook computer for Internet access. Follow the steps below to complete the setup process.

1. Before you continue with the setup wizard, power on your XV6900 and connect it to your notebook computer using the supplied USB cable.
2. On your XV6900, tap **Start > Programs > Modem Link**, then tap **Menu > Start**.

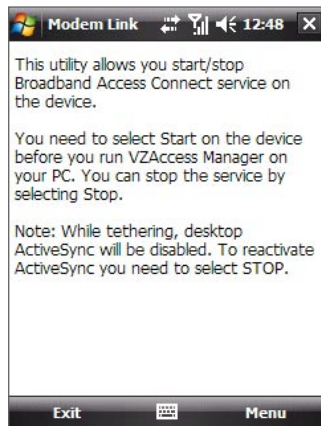

3. On the Welcome screen of the VZAccess Manager Setup Wizard, click **Next**.
4. Select **Detect WWAN device only** then click **Next**.

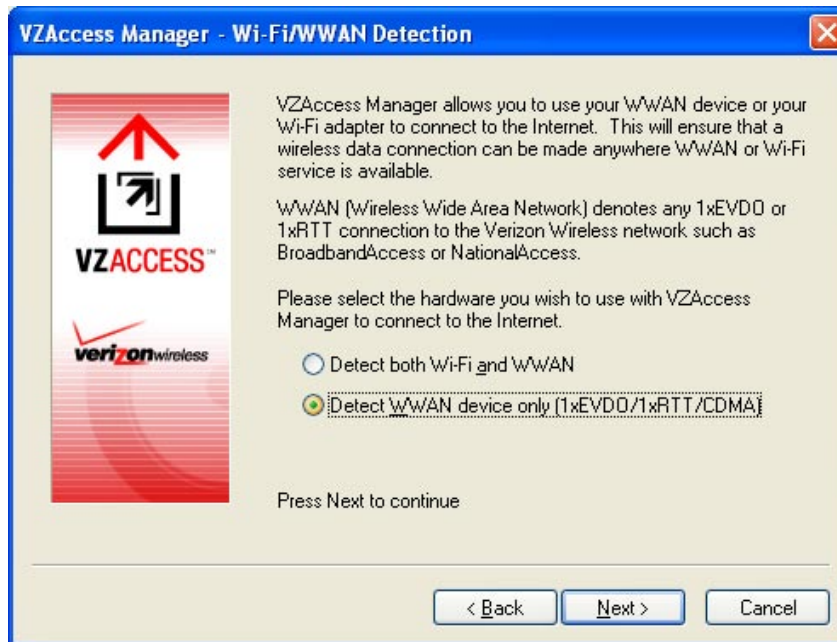

**Note** If your computer has built-in Wi-Fi or has a Wi-Fi card installed, you can select the **Detect both Wi-Fi and WWAN** option. This allows you to use either your XV6900 or your computer's Wi-Fi adapter to connect your notebook to the Internet. For more information, refer to the VZAccess Manager documentation on the CD.



5. VZAccess Manager will now detect and set up your XV6900. Click **Next**.
6. Select **Data Cable** and click **Next**.



7. Before proceeding, make sure your XV6900's modem driver is already installed on your computer. See "To install XV6900's modem driver" for details.

If the driver has already been installed, click **Next** to continue.

8. A message then appears, indicating that your XV6900 has been detected. Click **Yes**.



9. Your XV6900 is generally recognized as HTC USB Modem by VZAccess Manager. Click **Next** to proceed.



10. The mobile phone number that you use on your XV6900 is automatically recognized and then displayed on the next screen. Click **Next**.



11. You can set VZAccess Manager to automatically run whenever you start up your computer by selecting the **Run VZAccess Manager at Startup** check box.

12. Click **Finish**.

## Use VZAccess Manager to connect your notebook to the Internet

After you finished setting up VZAccess Manager on your notebook, the software automatically launches. You can also manually launch VZAccess Manager whenever you want to access the Internet on your notebook.

### To manually launch VZAccess Manager

1. Connect XV6900 to your notebook's USB port.
2. On your XV6900, tap **Start > Programs > Modem Link**, then tap **Menu > Start**.
3. On your notebook, double-click the **VZAccess Manager** icon on the Windows Desktop or click **Start > Programs > VZAccess Manager**.

### To connect to NationalAccess or BroadbandAccess

VZAccess Manager opens in Networks view, which lists all currently available network connections and indicates their respective signal strengths. Connect to the NationalAccess or BroadbandAccess service of Verizon Wireless so you can access the Internet on your notebook.

1. Double-click **NationalAccess - BroadbandAccess**
2. Click **Continue** to connect.

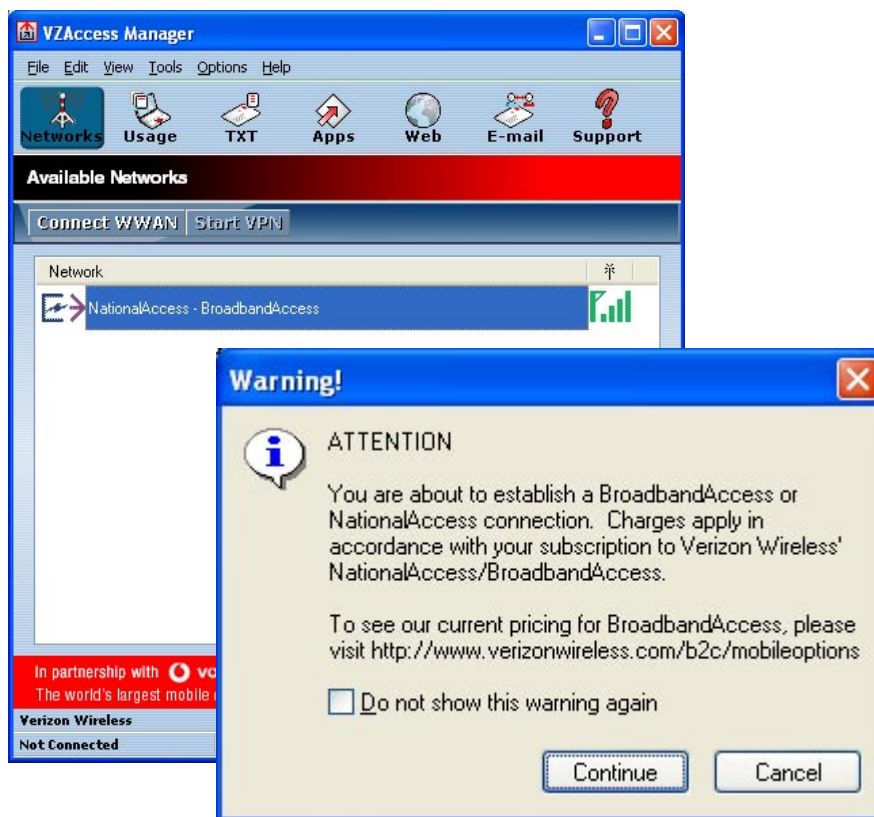

Once your notebook is successfully connected to the Internet, you will see a "Connected" status at the bottom left-hand side of VZAccess Manager's status bar. You can now surf the web and use e-mail on your notebook.

### To disconnect the Internet connection

1. Click **Disconnect** on VZAccess Manager.
2. On Modem Link of your XV6900, tap **Menu > Stop**.

## Overview of the user interface

One cool feature of VZAccess Manager is that it allows you to view, send and receive SMS text messages directly on the user interface. From VZAccess Manager, you can also launch Internet Explorer, open Outlook E-mail if it is your notebook's default e-mail software, and add shortcuts of your favorite applications.

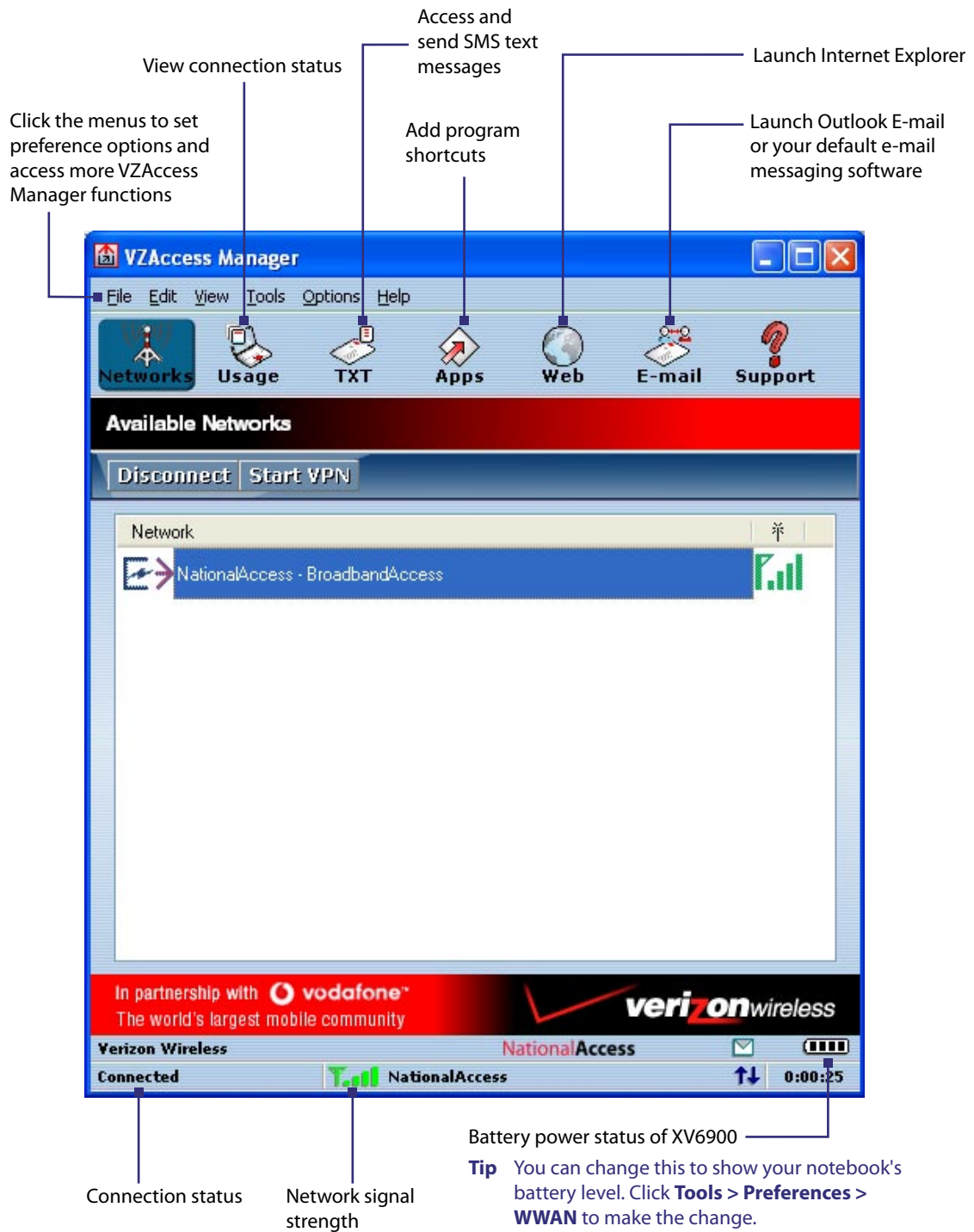

## Text messaging

Click  on VZAccess Manager to use its text messaging feature. VZAccess Manager then downloads SMS text messages from your XV6900 and lists them in the TXT Messaging view. You can manage your text messages right on this screen, such as check and read incoming text messages, reply, forward, etc.

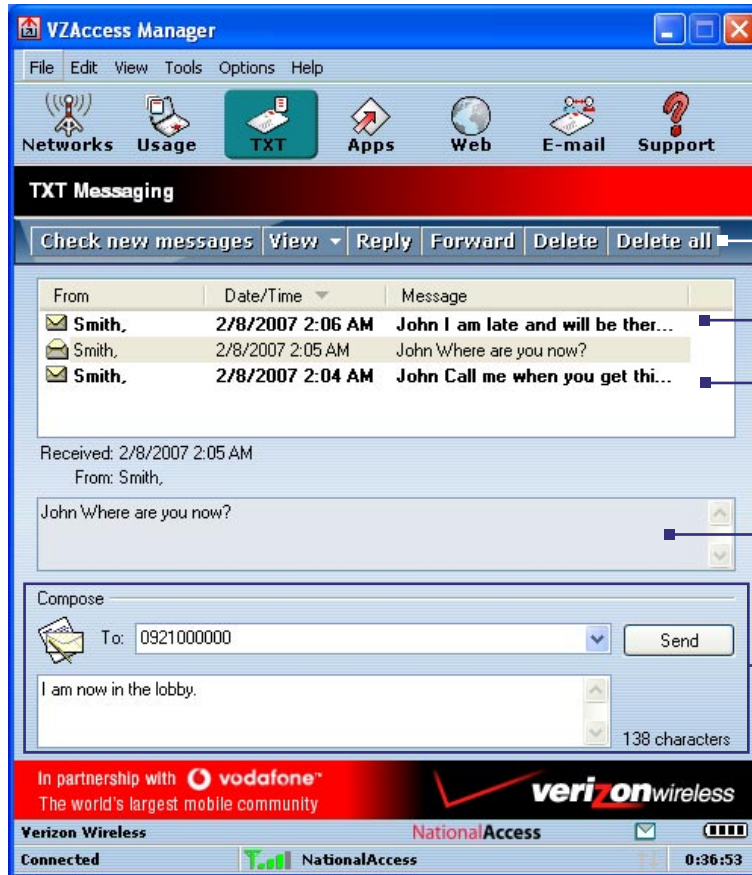

Click these tabs to choose messaging functions.

New incoming messages text messages appear in bold.

Shows the content of a selected message.

To reply or compose a new text message, enter the mobile phone number of the recipient and your message then click **Send**.

**Note** Text messages are synchronized between your XV6900 and VZAccess Manager.



# Chapter 11

## Experiencing Multimedia

**11.1 Camera**

**11.2 Camera Album**

**11.3 Pictures & Videos**

**11.4 Windows Media® Player Mobile**

## 11.1 Camera

Taking photos and recording video clips along with audio are easy with your XV6900's built-in camera.

### To open the Camera screen

- Press the CAMERA button on your XV6900; or
- Tap **Start > Programs > Camera**.

The screen orientation automatically switches to landscape mode when you open Camera.

### To exit the Camera

- Tap the **Exit** icon (  ) on the Camera screen.

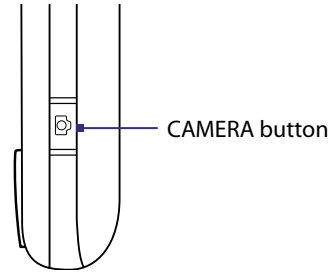

## Capture modes

The camera on your XV6900 allows you to capture pictures and video clips by using various built-in modes with flexibility. The Camera mode is set to the **Photo** capture mode by default. The upper left corner of the screen displays the active capture mode.

### To change the capture mode

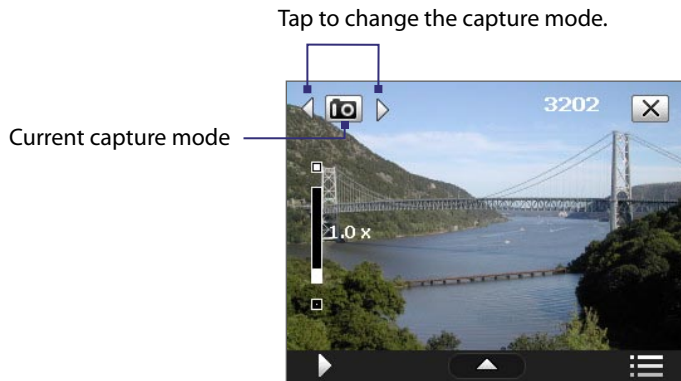

**Tip** You can also press NAVIGATION right or left to change the capture mode.

The available capture modes of the camera are as follows:

- **Photo:** Captures standard still images.
- **Video:** Captures video clips, with or without accompanying audio.
- **MMS Video:** Captures video clips suitable for sending with MMS messages.
- **Contacts Picture:** Captures a still image and gives you the option to immediately assign it as a Photo ID for a contact.
- **Picture Theme:** Captures still images and places them within frames.
- **Panorama:** Ideal for taking scenic shots. Captures parts of a scenery and then stitches all the shots to create a panoramic view of the scenery.
- **Sports:** Captures consecutive photo shots (3, 5, 7, or 10).
- **Burst:** Captures a sequence of still images (maximum 30) as long as the CAMERA button on the device or the ENTER button on the NAVIGATION Control is kept pressed.



## File formats supported

Using the available capture modes, the camera in your XV6900 captures files in the following formats:

Capture type	Format
Still image / Contacts Picture / Panorama / Sports / Burst	JPEG
Video	MPEG-4 (.mp4), Motion-JPEG (.avi), H.263 (.3gp), 3GPP2 (.3g2)
MMS Video	MPEG-4 (.mp4), H.263 (.3gp), 3GPP2 (.3g2)



## Camera controls

- Press CAMERA or ENTER to take a photo or contacts picture.
- Press CAMERA or ENTER to start recording video; press it again to stop recording.
- Press CAMERA or ENTER each time when taking photos for a picture theme.
- To take consecutive shots in Sports or Panorama mode, press CAMERA or ENTER shortly, then move your XV6900 to follow the movement of your subject.
- Press and hold the CAMERA button or the ENTER button when taking consecutive shots in Burst mode.

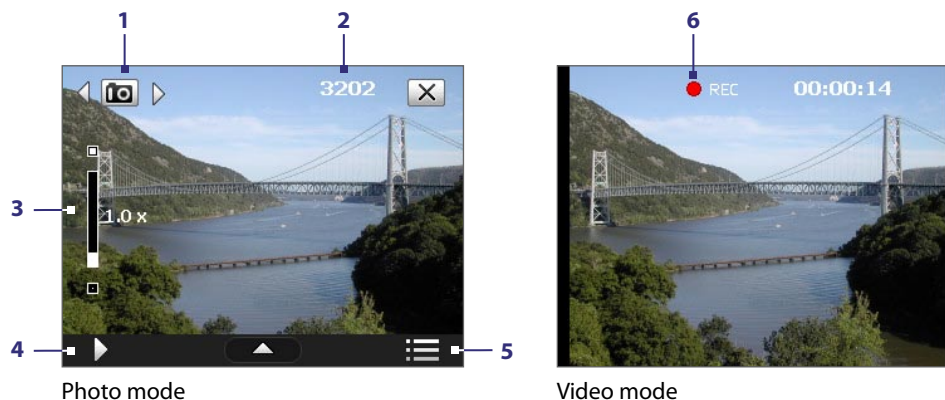
## On-screen controls and indicators



**Note** The on-screen controls and indicators are displayed for a few seconds only and are then hidden from the Camera screen. To bring up the on-screen controls and indicators again, simply touch or tap the screen, or press NAVIGATION up/down/left/right.

- 1 Mode Switching control.** Tapping the left/right arrow (◀/▶) on the screen allows you to switch the capture mode.
- 2 Remaining information indicator.** In Photo, Contacts Picture, Picture Theme, Panorama, Sports, and Burst modes, this shows the remaining, available shots of pictures based on current settings. In Video and MMS Video modes, this shows the remaining duration that can be recorded. While recording video, this shows the recorded duration.
- 3 Zoom control.** Tapping the  /  icon on the screen allows you to zoom in or zoom out.

**Note** This control only appears when zooming is supported by the **Resolution** you have selected.

- 4 Album.** Tap to view the photos and videos on the device or storage card.
- 5 Menu.** Tap to open the Camera Settings screen.
- 6 Recording indicator.** This shows a red, flashing indicator while video recording is in progress.

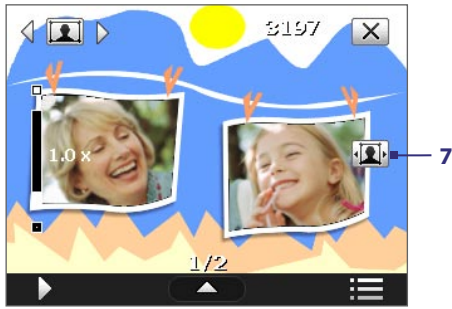

Picture Theme mode

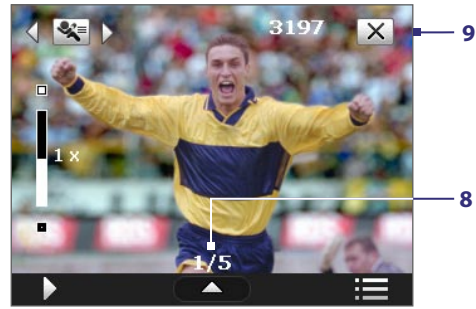

Sports mode

**7 Template Selector icon.** In Picture Theme mode, tap to toggle among the different templates.

**8 Progress indicator.** In Picture Theme, Panorama, Sports and Burst modes, this shows the number of consecutive shots.

**9 Exit.** Tap  to exit the Camera program.

## Zooming



Before capturing a still image or a video clip, you can zoom in to make the object in focus move closer or zoom out to make the object move farther away.

**Note** The zoom control only appears onscreen when zooming is supported by the **Resolution** you have selected.

The camera zoom range for a picture or a video clip depends on the capture mode and capture size. The following table is a summary.

Capture mode	Capture size setting	Zoom range
<b>Photo</b>	2M (1600 x 1200)	No zooming available
	1M (1280 x 960)	1.0x to 2.0x
	Large (640 x 480)	1.0x to 2.0x
	Medium (320 x 240)	1.0x to 4.0x
<b>Video</b>	Small (160 x 120)	1.0x to 8.0x
	Medium (176 x 144)	1x and 2x
<b>MMS Video</b>	Small (128 x 96)	1x and 2x
	Medium (176 x 144)	1x and 2x
<b>Contacts Picture</b>	Large (480 x 640)	1.0x to 2.0x
	Medium (240 x 320)	1.0x to 4.0x
<b>Picture Theme</b>	Determined by the current template	Depends on the size of the template currently loaded
<b>Panorama</b>	Large (640 x 480)	1x and 2x
	Medium (320 x 240)	1x, 2x and 4x
<b>Sports</b>	Large (640 x 480)	1x and 2x
	Medium (320 x 240)	1x, 2x and 4x
<b>Burst</b>	Large (640 x 480)	1x and 2x
	Medium (320 x 240)	1x, 2x and 4x

### To zoom in and zoom out

- On your XV6900, press NAVIGATION up/down to zoom in/out; or
- Tap the  icon above the Zoom Ratio indicator to zoom in; tap the  icon below the Zoom Ratio indicator to zoom out. When the zooming limit is reached, you will hear a beep.

## Quick Settings Panel

The Quick Settings Panel provides a quick way of adjusting the most common camera settings. Tap on the screen to open the Quick Settings Panel. Keep tapping a button on the panel, for instance, **Resolution**, to cycle through the available settings.

**Note** The available settings on the menu depend on the Capture mode selected.

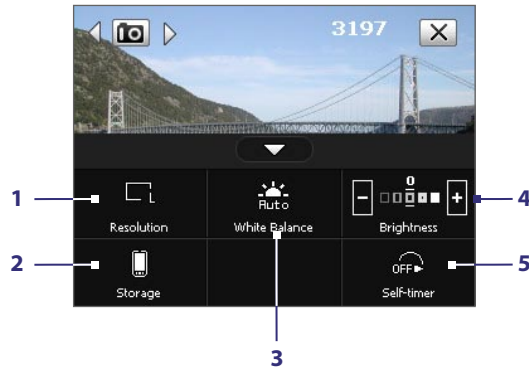

- 1 Resolution.** Available resolutions include: . See the table in the previous page for the detailed capture sizes.
- 2 Storage.** Tap to toggle between saving captured photos or video clips on the device memory () or on the storage card ()
- 3 White Balance.** White balance settings include: Auto () , Daylight () , Night () , Incandescent () , and Fluorescent () .
- 4 Brightness.** Tapping the minus/plus icon () decreases or increases the brightness level.
- 5 Self-timer.** Tap to set the Self-timer to **2 seconds**, **10 seconds**, or **Off** when in the Photo or Contacts Picture mode. When you press the CAMERA or ENTER button to capture a still image, it starts to count down, and then captures a still image after the assigned time.

## The Review screen

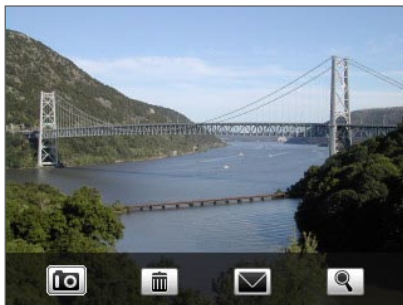



Review screen

After taking a still image or recording a video clip, you can view the image or video clip on the **Review screen**.

You can also tap the following icons at the bottom of the Review screen:

Icon	Function
	<b>Back:</b> Go back to the live Camera screen.
	<b>Delete:</b> Remove the captured image or video.
	<b>Send:</b> Send via e-mail or MMS.
	<b>View:</b> View the captured photo or play the recorded video.

Icon	Function
	<b>Assign to Contacts:</b> Associate the photo to a selected contact.
	<b>Browse:</b> After capturing in Sports or Burst mode, the total number of consecutive shots is shown in the lower right corner of the Review screen. Tap the up/down arrow to browse through the sequence of photos.

## Camera settings

Tap the **Menu** icon () to open the Camera Settings screen. The Camera Settings screen allows you to configure **Capture Settings** and **Advanced** settings.

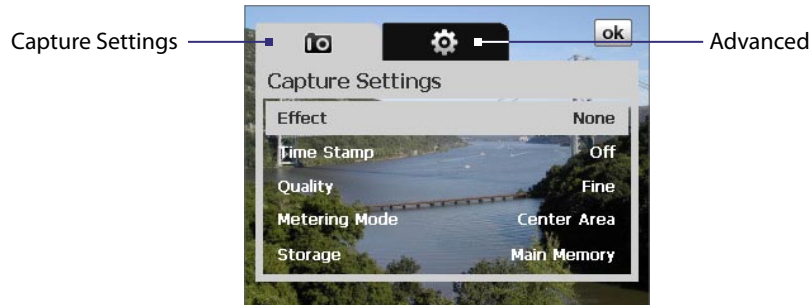

Camera Settings screen in Photo mode

When you tap the menu buttons (**Capture Settings** and **Advanced**) at the top of the Camera Settings screen, different menus will appear. Some menus and options may be available only in certain capture modes.

You can either tap on-screen or press the Navigation Control buttons to navigate the Camera Settings screen.

### Capture Settings menu

- **Effect.** Choose a special effect such as **Grayscale**, **Sepia**, etc., to apply to your photos or video clips.
- **Time Stamp** (Photo, Sports and Burst modes). Choose whether or not to include the shooting date and time on captured photos.
- **Quality.** Select the JPEG image quality level for all captured still images. Choose from **Basic**, **Normal**, **Fine**, and **Super Fine**.
- **Metering Mode.** Select a metering mode to allow the camera to measure the amount of light and calculate the best-fit exposure value before capturing. Choose either **Centre Area** to measure light using the centre area of the image or **Average** to measure light using the area all around the image.
- **Storage.** Select where you want to save your files. You can either save the files to the **Main Memory** or to a **Storage Card**.
- **Template** (in Picture Theme mode only). Select a template.
- **Direction** (in Panorama mode only). Choose in what direction images will be stitched in a panorama.
- **Stitch Count** (in Panorama mode only). Select the desired number of snapshots to be taken and stitched into a panorama.
- **Capture Speed** (Sports and Burst modes). This determines the interval between shots. **Fast** captures consecutive shots at the shortest interval.
- **Snapshots** (in Sports mode only). Select the number of consecutive shots to capture.

## Advanced menu

- **Capture Format.** Select the desired file format.
- **Shutter Sound.** Choose whether or not you want the camera to make a shutter sound when you press the ENTER or CAMERA button.
- **Grid** (Photo mode only). Choose whether or not to show a grid on the Camera screen. Showing a grid helps you frame and centre your subject more easily and accurately.



- **Keep Backlight.** Turn the backlight on or off. This overrides the device backlight settings while you are using the camera.
- **Review Duration.** Set a time length for displaying the captured image/video on the Review screen. Select **No Limit** if you do not want to impose a time limit. Select **No Review** to immediately return to the live Camera screen after capturing and saving.
- **Flicker Adjustment.** When taking indoor shots, flicker on the camera screen may be caused by inconsistencies between the vertical scan rate of the camera display and the flicker frequency of fluorescent lighting. To reduce flicker, you can change the flicker adjustment setting to the proper frequency (**50Hz** or **60Hz**) of the country where the device is being used.
- **Record with Audio** (Video and MMS Video modes only). Select **On** to record audio with the captured video clips, or select **Off** to capture video without audio.
- **Prefix.** When **Default** is selected as the prefix, the file name of each new captured file is set to "IMAGE" or "VIDEO" followed by a sequential number, for example: IMAGE\_001.jpg. You may also choose to name files using either the current **Date** or **Date & Time** as the prefix.

**Note** If you set the Camera to save captured photos to a storage card, the prefix cannot be selected. Captured photos will be named using the convention IMAGnnnn.jpg (wherein 'nnnn' is the counter) which is the DCIM (Digital Camera Images) naming standard, and will be saved to the \DCIM\100MEDIA folder on the storage card.

- **Counter.** To reset the file naming counter back to 1, tap **Reset**.
- **Recording Limit** (in Video mode only). Set the duration or file size for recording video.
- **Template Folder** (in Picture Theme mode only). By default, templates are stored in the **\My Documents\Templates** folder on the device's **Main Memory**. If you transferred some templates to a storage card (via File Explorer), set this option to **Main + Card** to specify that templates are located in both the main memory and the storage card.
- **Image Properties.** This option allows you to adjust the camera display properties, such as **Contrast, Saturation, Hue, and Sharpness**.

- 1 Tap a property to adjust.
- 2 Tap the left/right arrow or press NAVIGATION left/right to decrease/increase the value.
- 3 Tap to save the settings.
- 4 Tap to reset all properties to their default.
- 5 Tap to close the submenu without applying and saving the changes.

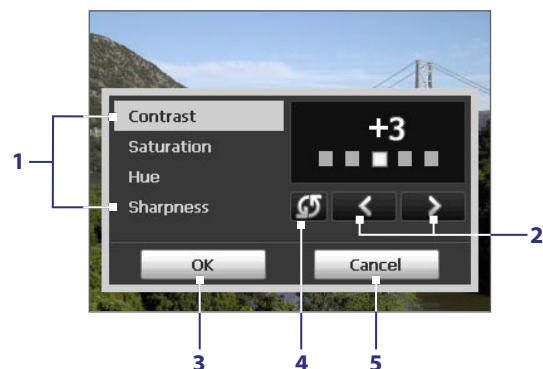

- **Show Reminder** (in Contacts Picture mode only). Select **On** if you want the Camera to always display a message that confirms whether or not to assign the captured picture to a contact.

## 11.2 Camera Album

View your photos and videos using Camera Album. Camera Album offers a host of features that let you rotate images, view your images as a slide show, use images as contacts pictures, and more.

**Note** Only files supported by your XV6900's camera are displayed in Camera Album. To check which file formats are supported, see "Supported File Formats" in the Camera section.

### To open Camera Album

- Tap **Start > Programs > Camera Album**; or
- In the Camera program, tap .

Depending on the capture mode you are in, Camera Album will show either still images or video clips in your XV6900. For example, if you are in Photo mode, only still images will be shown in Camera Album.

To view video clips, switch first to Video or MMS Video mode before tapping .

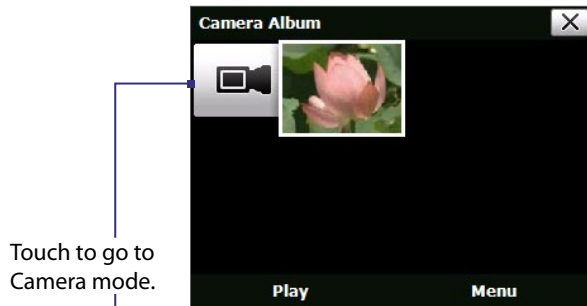

Opened from video capture mode

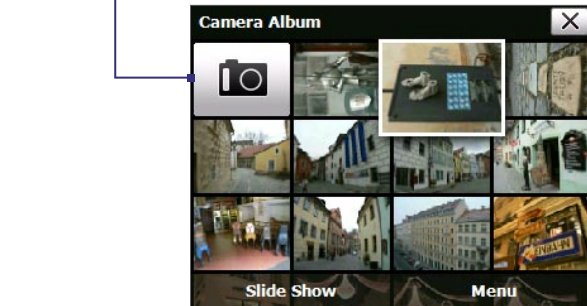





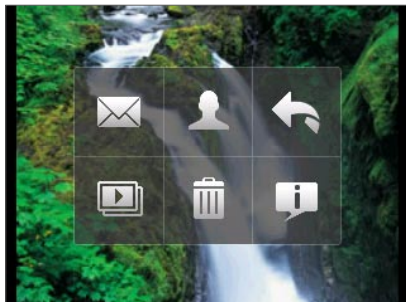

Opened from still image capture mode

**Tip** If you have a lot of images in the device, scroll up or down by sliding your finger upward or downward on the touch screen.

### To view an image

On the main Camera Album screen, touch the thumbnail of the image you want to view. While viewing an image, touch the screen to open the onscreen menu.



-  Touch to send the image via one of your Messaging accounts.
-  Touch to assign the image as a contact picture.
-  Touch to return to the main Camera Album screen.
-  Touch to start the slide show.
-  Touch to delete the image.
-  Touch to show you how to use gestures in Picture View of Camera Album.



While viewing an image, you can advance to the next image or go back to the previous image; rotate the image; zoom in or out on the image, and more.

### To advance to the next image or go back to the previous image

- Advance to the next image by sliding your finger across the screen from right to left; or
- Go back to the previous image by sliding your finger from left to right.

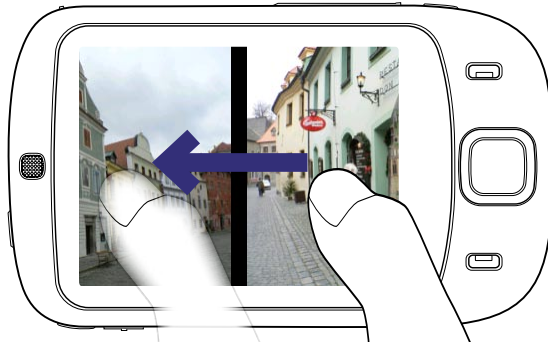

### To rotate the image

With your finger, make a half-circle motion on the screen.

- Slide your finger clockwise to rotate the image 90 degrees clockwise; or
- Slide your finger counter-clockwise to rotate the image 90 degrees counter-clockwise.

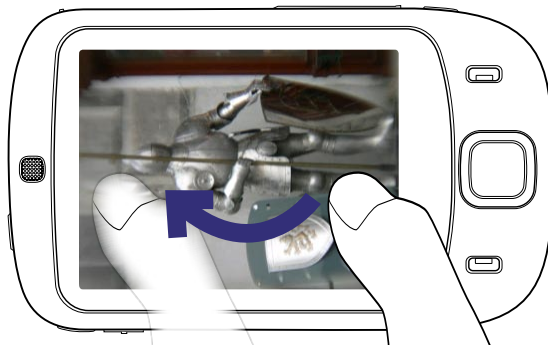

### To zoom in or out of an image

With your finger, make a full-circle motion on the screen.

- Slide your finger clockwise to zoom in; or
- Slide your finger counter-clockwise to zoom out.



- Tips**
- When you zoom in on an image, you can double-tap the screen to automatically zoom out and fit the image to the screen.
  - When you zoom in on an image, touch and hold the screen so you can pan the image.

**To view the images as a slide show**

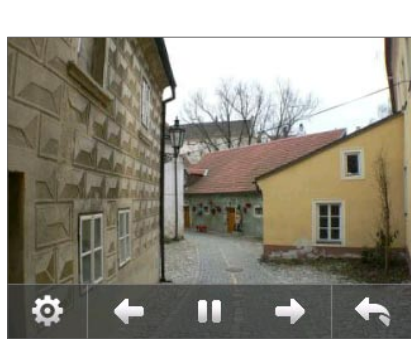

Touch to open the slide show options where you can set the transition effect, time per slide, and orientation of the images.



Touch to go back to the previous image.



Touch to play or pause slideshow playback.



Touch to advance to the next image.



Touch to return to the main Camera Album screen.

**To play back video files**

On the main Camera Album screen, touch the thumbnail of the video clip you want to play back. Windows Media Player then plays back the clip.

**Tip** You can also select a video clip and tap Play to play back the clip in Windows Media Player.

**To close Camera Album**

- Go back to the main Camera Album screen and touch ; or
- When you open Camera Album from the Camera mode, touching takes you back to the Camera program.

## 11.3 Pictures & Videos

**Pictures & Videos** allows you to manage the following types of media files on your XV6900:

File Type	File Extensions
<b>Image</b>	*.bmp, *.jpg, *.gif, *.png
<b>GIF animation</b>	*.gif
<b>Video</b>	*.avi, *.wmv, *.mp4, *.3gp, *.3g2
<b>Audio</b>	*.wma

**To open Pictures & Videos**

- Tap **Start > Programs > Pictures & Videos**.

**To copy media files to your XV6900**

- Copy pictures and GIF animation files from your PC or a storage card to the My Pictures folder on your XV6900.
- Copy video files to the My Videos folder.



For more information about copying and managing files on your XV6900, see Chapter 9.

### To view pictures

1. The images in the My Pictures folder appear as thumbnails by default.
2. Select a picture and tap **View**. If you cannot find a picture in the default My Pictures folder, go to another folder by tapping the Down arrow (▼).

### To play GIF animation files

1. Select a GIF animation file (marked with a ) and tap **View**.
2. The GIF Animation program then opens and plays the animation.

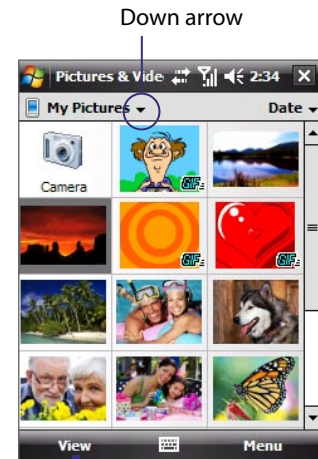

Tap to view the selected image.

### To play videos

1. By default, the contents of the My Pictures folder will be shown.
2. To find the video clips that you captured, tap the down arrow (▼) next to the My Pictures folder and tap **My Documents > My Videos**. Video clips are displayed as thumbnails by default, which appear with a media icon (.
3. Tap to select a video and play it in Windows Media® Player Mobile.

## Pictures & Videos menu

Select a media file and then tap **Menu** to choose from a list of options that you can do with the selected media file.

You can send the selected media file via one of your messaging accounts or beam it to another device. If you selected a picture, you can associate it to a contact, set it as your Today screen background, send it to your Windows Live Space account, and more. You can also view the images in the My Pictures folder as a slide show.

**Note** The available menu options depend on the selected media file.

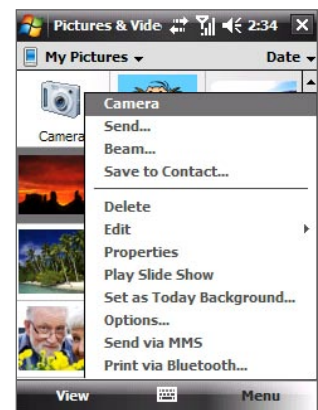

### To edit a picture

You can rotate, crop, and adjust the brightness and color contrast of your pictures.

1. On the Pictures & Videos screen, tap the picture you want to edit.
2. Tap **Menu > Edit**, and do any of the following:
  - To rotate a picture 90 degrees clockwise, tap **Rotate**.
  - To crop a picture, tap **Menu > Crop**. Next, tap and drag to select the area to crop. Tap inside the box to crop, or tap outside the box to cancel cropping.
  - To adjust the brightness and contrast levels of a picture, tap **Menu > Auto Correct**.

**Note** To undo an edit, tap **Menu > Undo**. To cancel all unsaved edits you made to the picture, tap **Revert to Saved**.

## 11.4 Windows Media® Player Mobile

You can use Windows Media® Player Mobile to play digital audio and video files that are stored on your XV6900 or on a network, such as on a Web site.

Video File Formats Supported	File Extensions
Windows Media Video	.wmv, .asf
MPEG4 Simple Profile	.mp4
H.263	.3gp, .3g2
H.264	.mp4, .3gp, .3g2, .m4v
Motion JPEG	.avi

Audio File Formats Supported	File Extensions
Windows Media Audio	.wma
WAV	.wav
MP3	.mp3
MIDI	.mid, .midi, .rmi
AMR Narrow Band	.amr
AMR Wide Band	.awb
AAC, AAC+ and eAAC+	.aac, .mp4, .m4a
MPEG4 audio	.mp4, .m4a
QCELP	.qcp

### To open Windows Media® Player Mobile

- Tap **Start** > **Programs** > **Windows Media**.

### About the controls

The following are available controls on the Windows Media® Player Mobile.

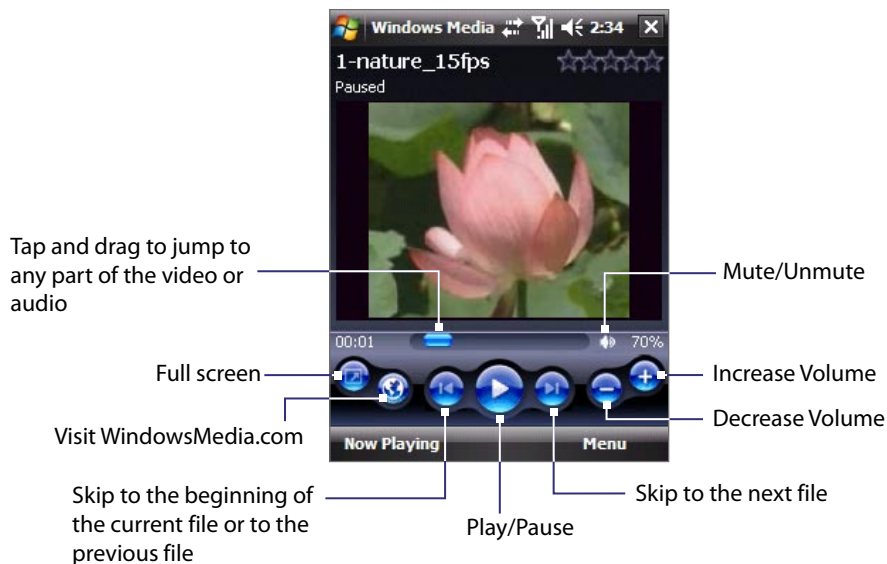

## About the screens and menus

Windows Media® Player Mobile has three primary screens:

- **Playback screen.** The screen that displays the playback controls (such as Play, Pause, Next, Previous, and Volume) and the video window. You can change the appearance of this screen by choosing a different skin.
- **Now Playing screen.** The screen that displays the Now Playing playlist. This special playlist indicates the current file being played and any files that are “queued up” to play next.
- **Library screen.** The screen that lets you quickly find your audio files, video files, and playlists. It contains categories such as My Music, My Videos, My TV, and My Playlists.

At the bottom of each screen, you can open a **Menu**. The commands on this menu vary, depending upon which screen you are viewing. For more information about the commands in these menus, see Help on your XV6900.

## Synchronize video and audio files

Use the latest version of Windows Media® Player on your PC to synchronize digital media files from your PC to your XV6900. This ensures that protected files and album art (for skins) are copied to the device correctly.

### To synchronize content to your XV6900 automatically

1. On your PC, start Windows Media® Player and then connect your XV6900 to your PC.
2. In the Device Setup Wizard, select **Yes, search my computer now**.
3. You will then see the name of the device (or “Storage Card” if you have inserted one on the device). Click **Finish**.
4. On the left panel of Windows Media® Player, right-click the name of the device then click **Set Up Sync**.

**Note** To set up media synchronization on a storage card, right-click **Storage Card** in the left panel of Windows Media® Player, then click **Set Up Sync**.

5. On the Device Setup dialog box, select **Sync this device automatically**.
6. Select the playlist(s) that you want to sync between your PC and device, then click **Add**.
7. Click **Finish**.

The files begin synchronizing to the device. The next time you connect your XV6900 to your PC while Windows Media® Player is running, synchronization will start automatically.

### To synchronize content manually to your XV6900

1. If you have not set up media synchronization between your XV6900 and PC, follow steps 1 to 3 in “To synchronize content to your XV6900 automatically”.
2. Click the **Sync** tab on the Windows Media® Player of your PC. Select a Playlist or a Library on the left panel of the Windows Media® Player.
3. From the Content List, drag the media files that you want to sync to the device and drop them to the Sync List.
4. Click **Start Sync** to start synchronizing the selected files to the device.

**Notes**

- Use Windows Media® Player 11 or higher on your PC to synchronize media files to your XV6900.
- Audio files copy faster if Windows Media® Player is configured to automatically set the quality level for audio files copied to your XV6900. For more information, see the Windows Media® Player Help.



## Play media

Use the Library to find and play songs, videos, and playlists that are stored on the device or removable storage card.

### To update the Library

1. If you are not on the Library screen, tap **Menu > Library**.
2. On the Library screen, tap the Library arrow (near the top of the screen), then tap the media storage that you want use, for example, Storage Card.
3. In most cases, Windows Media® Player Mobile automatically updates the library. However, you can manually update the library to ensure that it contains new files that you recently copied to the device or storage card. Tap **Menu > Update Library** to manually update the library list.

### To play video and audio files on your XV6900

1. Select a category (for example, My Music or My Playlists).
2. Tap and hold the item that you want to play (such as a song, album, or artist name), then tap **Play**.

- Tips**
- To play a media file that is stored on your XV6900 but is not in a library, on the Library screen, tap **Menu > Open File**. Tap and hold the item that you want to play (such as a file or a folder), then tap **Play**.
  - To play a media file from the Internet or a network server, tap **Menu > Library** then tap **Menu > Open URL**.

## Playlists

In Windows Media® Player Mobile, you can create a new playlist by saving the current Now Playing playlist and giving it a new name.

### To save a new playlist

1. If you are not on the Library screen, tap **Menu > Library**.
2. Tap to select a category (for example, My Music or My Playlists).
3. Select a media file that you want, then tap **Menu > Queue Up**. This adds the file to the Now Playing list. Repeat this step until you have added all desired media files to the Now Playing list.

**Note** You cannot select multiple files simultaneously.

4. After adding the media files, tap **Menu > Now Playing**.
5. On the Now Playing screen, tap **Menu > Save Playlist**.
6. Enter the playlist name then tap **Done**.
7. To play back the playlist you created, tap My Playlists in the Library, select your playlist, then tap **Play**.

## Troubleshooting

If you encounter a problem while using the Windows Media® Player Mobile, a number of resources are available to help you troubleshoot the issue.

For more information, see the Troubleshooting Windows Media® Player Mobile page at the Microsoft Web site (<http://www.microsoft.com/windows/windowsmedia/player/windowsmobile/troubleshooting.aspx>).



# Chapter 12

## Managing Your XV6900

**12.1 Adding and Removing Programs**

**12.2 Using Task Manager**

**12.3 Resetting Your XV6900**

**12.4 Managing Memory**

**12.5 Windows Update**

**12.6 Battery Saving Tips**

## 12.1 Adding and Removing Programs

Before you purchase additional programs for your XV6900, make sure that they are compatible with your XV6900.

### To add programs

1. Download the program to your PC (or insert the CD or disk that contains the program into your PC). You may see a single \*.**exe** file, a \*.**zip** file, a Setup.exe file, or several versions of files for different device types and processors. Be sure to select a program designed for your XV6900 and processor type.
2. Read any installation instructions or documentation that comes with the program. Many programs provide special installation instructions.
3. Connect your XV6900 to the PC.
4. Double-click the \*.**exe** file.



### To remove programs

1. Tap **Start > Settings > System tab > Remove Programs**.
2. In the **Programs in storage memory** list, select the program you want to remove, and tap **Remove**.

## 12.2 Using Task Manager

**Task Manager** lets you view and stop running programs, configure the Exit button () , and enable the Quick Menu on the Today screen.

### To open Task Manager

- Tap the **Quick Menu** button () on the top right corner of the Today screen to open the Quick Menu, and then tap the **Options** icon (); or
- Tap **Start > Settings > System tab > Task Manager**.

### To switch back to a running program



- Tap the program name in the Quick Menu; or
- On the Task Manager screen, tap and hold the program name in the **Running** tab, then tap **Activate**.

### To configure the Exit button ()

You can configure the **Exit** button () to shut down running programs when the button is tapped, or to just temporarily close the program screen but keep the program running.

1. On the Task Manager screen, tap the **Button** tab.
2. Select the **Enable the “X” button to end running programs** check box.

**Note** When the **Enable the “X” button to end running programs** check box is not selected, tapping the **Exit** button will only close a program screen. The program is not ended and continues to run in the background.

3. Choose the action for shutting down programs (by tapping the  button, tapping and holding the  button, or both).
4. Tap **OK**.



### To close running programs from the Task Manager

1. Tap the **Running** tab.
2. Do one of the following:
  - Select the check box of the programs that you want to close, and then tap **Stop Selected** to close them.
  - Tap **Stop All** to close all programs in the list.
  - Tap **Menu > Stop All but Selected** to close all programs except for those whose check boxes are selected.

**Tip** You can also close running programs from the Quick Menu on the Today screen. See "Quick Menu" in Chapter 1 for details.

### To add a running program to the exclusive list

If you add a running program to the **Exclusive Programs List**, it will not be closed when you tap **Stop Selected** or **Stop All** and will not be listed in the Quick Menu on the Today Screen.

1. On the Task Manager screen, tap the **Running** tab.
2. Tap and hold the program name in the list, then tap **Add Exclusive**.

### To remove a program from the exclusive list

- In the **Running** tab, tap and hold the program name in the list, and then tap **Remove from Exclusive**; or
- In the **Exclusive** tab, select the program name and tap **Remove**.

### To sort running programs in the Quick Menu

1. Tap the **Advanced** tab.
2. Select **Program name** or **Memory usage** to sort running programs by order of the program name or memory usage.

## 12.3 Resetting Your XV6900

### Soft reset

Occasionally, you may need to reset your XV6900. A soft (or normal) reset of your XV6900 clears all active program memory and shuts down all active programs. This can be useful when the device is running slower than normal, or a program is not performing properly. A soft reset is also necessary after the installation of some programs. If a soft reset is performed when programs are running, unsaved work will be lost.

### To perform a soft reset

Use the stylus to press the RESET button found at the bottom of your device. Your device restarts and displays the Today screen.

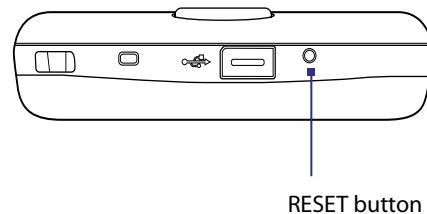

## Hard reset

You can also perform a hard reset (also known as a full reset). A hard reset should be performed only if a normal reset does not solve a system problem. After a hard reset, the device is restored to its default settings - the way it was when you first purchased it and turned it on. Any programs you installed, data you entered, and settings you customized on the device will be lost. Only Windows Mobile software and other pre-installed programs will remain.

### To perform a hard reset

1. Press and hold the TALK and END buttons, and at the same time, use the stylus to press the RESET button at the bottom of your XV6900.
2. Release the stylus, but continue pressing the TALK and END buttons until you see the following message on the screen:

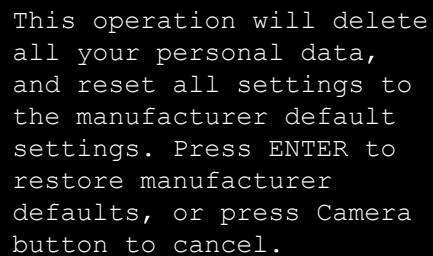

```
This operation will delete  
all your personal data,  
and reset all settings to  
the manufacturer default  
settings. Press ENTER to  
restore manufacturer  
defaults, or press Camera  
button to cancel.
```

3. Release the TALK and END buttons, and then press ENTER on your XV6900.

**Warning!** Your XV6900 will be set back to factory default settings. Please ensure any additional installed programs and/or user data have been backed up before a hard reset is performed.

## Clear Storage

Another way of clearing the device storage and reset all settings back to factory default settings is to use the **Clear Storage** feature. You will lose all your data and files on the device storage when you use Clear Storage, so make sure to do a backup first.

1. Tap **Start > Settings > System tab > Clear Storage**.
2. Enter "1234" then tap **Yes**.

## 12.4 Managing Memory

To see how much memory is available for use, tap **Start > Settings > System tab > Memory**. On the **Main** tab, the amount of memory allocated to file and data storage versus program storage is displayed, as well as the amount of memory in use versus the available memory.

To see available storage card memory, tap **Start > Settings > System tab > Memory > Storage Card** tab.

If the device is running low on memory, try the following to free memory on your XV6900:

- Close programs you are not currently using.
- Move e-mail attachments to a storage card.
- Move files to a storage card. Tap **Start > Programs > File Explorer**. Tap and hold the file, and tap **Cut**. Browse to the storage card folder and tap **Menu > Edit > Paste**.
- Delete unnecessary files. Tap **Start > Programs > File Explorer**. Tap and hold the file, and tap **Delete**.
- Delete large files. To find your largest files, tap **Start > Programs > Search**. In the **Type** list, tap **Larger than 64 KB**, and tap **Search**.
- In Internet Explorer Mobile, delete temporary Internet files and clear history information. For more information, see "Internet Explorer® Mobile" in Chapter 10.
- Remove programs you no longer use.
- Reset your XV6900.

## 12.5 Windows Update

You can update Windows Mobile® on your XV6900 with security patches or fixes, if they are available.

### To set up Windows Update

The first time you run Windows Update, you need to set up how you want Windows Update to check for patches on the Microsoft Web site.

1. Tap **Start > Settings > Systems tab > Windows Update**.
2. On the Update Setup screen, tap **Next**.
3. Select how you want to check for updates, **Manual** or **Automatic**, then tap **Next**.

**Note** If you select **Automatic**, you will be asked if you want to use your current data plan to check for updates. Select or clear the **Use my data plan to check for and download updates** check box and tap **Next**.

4. Tap **Finish**.

### To check for updates

1. Tap **Start > Settings > Systems tab > Windows Update**.
2. Tap **Check Now**.

**Note** Windows Mobile® updates may not be available at all times. You can check the Windows Mobile® Web site for update information.

## To change Windows Update options

1. Tap **Start > Settings > Systems tab > Windows Update**.
2. Tap **Menu** and select the option you want to change.
  - Tap **Connections** to change how the device connects to the Internet when checking for updates.
  - Tap **Change Schedule** to change how Windows Update checks for Windows Mobile® updates.

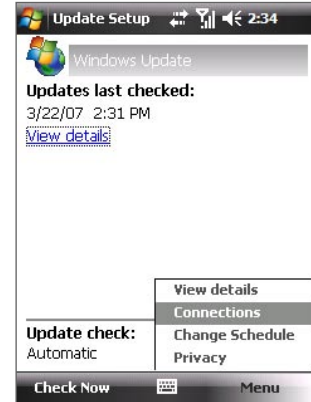

## 12.6 Battery Saving Tips

How long your battery power lasts depends on battery type and how you use your XV6900. Try the following to help preserve battery life:

- When the device is not in use, press POWER to switch off the display.
- Open the Power Settings screen by tapping the **Battery** icon (  ) on the Today screen or by tapping **Start > Settings > System tab > Power**. On the **Advanced** tab of the Power settings screen, you can specify when your XV6900 automatically turns off the display to conserve battery power. For optimum conservation, specify 3 minutes or less.
- Use the AC adapter to plug your XV6900 into external power whenever possible, especially when using a storage card or when using a modem or other peripherals.
- Adjust the backlight settings. For more information, see “To set the backlight to dim after a time delay” in Chapter 4.
- Turn Bluetooth off when you are not using it. Make your XV6900 visible to other devices only when you are trying to establish a Bluetooth partnership. For more information about Bluetooth, see Chapter 10.
- Lower the volume.
- Close battery-intensive programs, such as the Camera, when you are done using them. Make sure the programs are ended and are not continuously running in the background.

# Chapter 13

## Using Other Applications

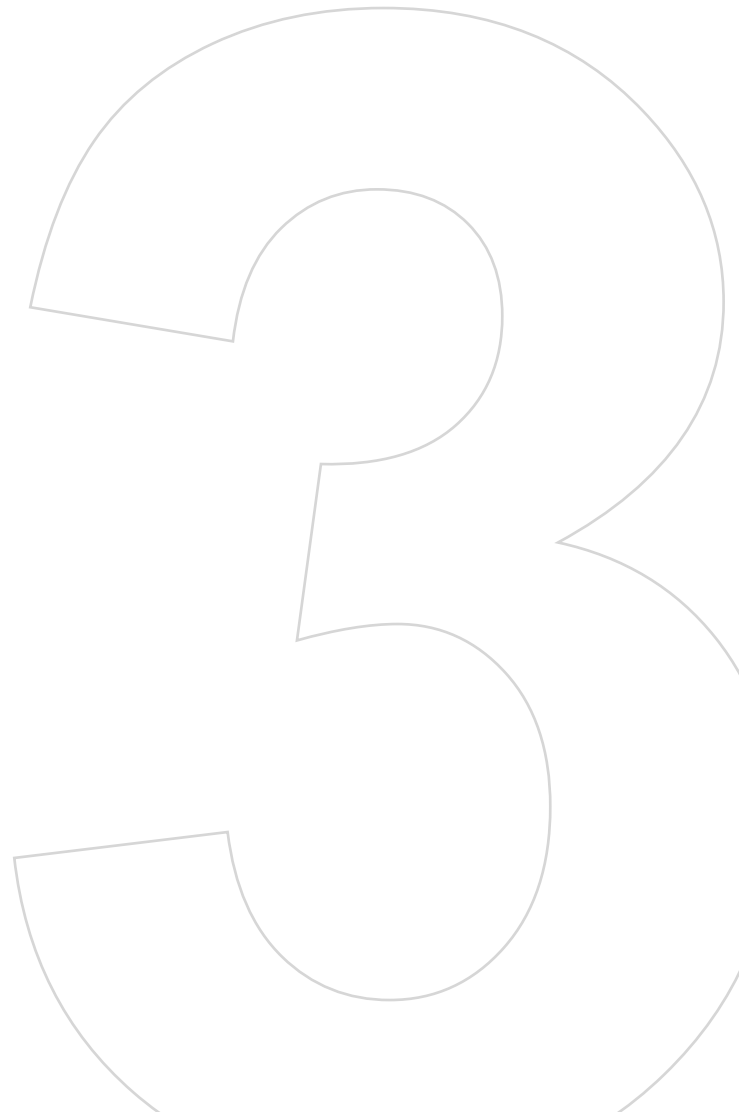
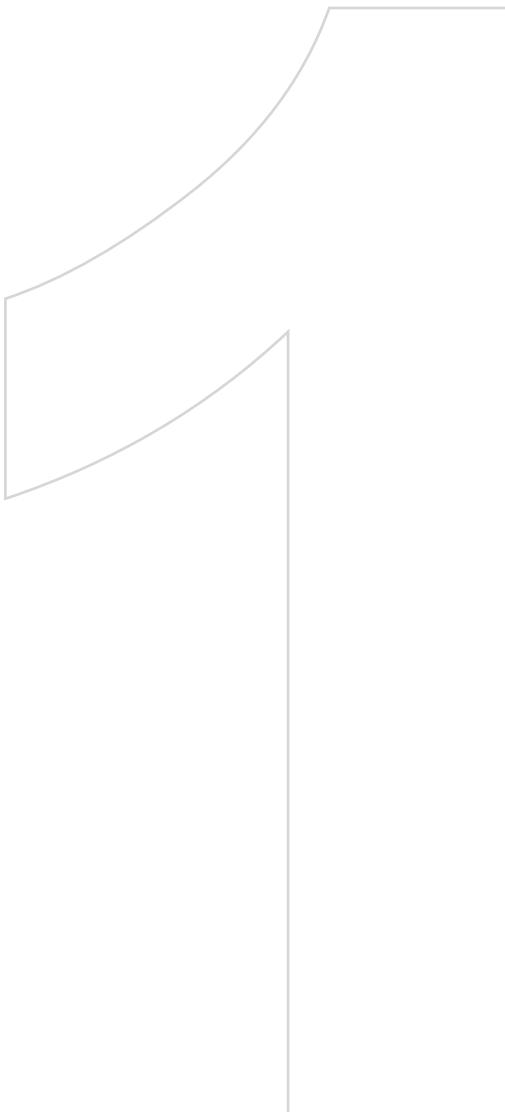

### 13.1 Voice Speed Dial



## 13.1 Voice Speed Dial

You can record voice tags so that you can dial a phone number or launch programs simply by speaking a word.

### Create a voice tag for a phone number

1. Tap **Start > Contacts** to open the Contacts list.
2. Do one of the following:
  - Tap and hold the desired contact, then tap **Add Voice Tag**.
  - Select the desired contact, then tap **Menu > Add Voice Tag**.
  - Tap the desired contact to open the contact's detailed screen, then tap **Menu > Add Voice Tag**.
3. Select the phone number that you want to create a voice tag, then tap the Record button (  ).
4. When completed, a **Voice Tag** icon (  ) will be displayed on the right of the item.

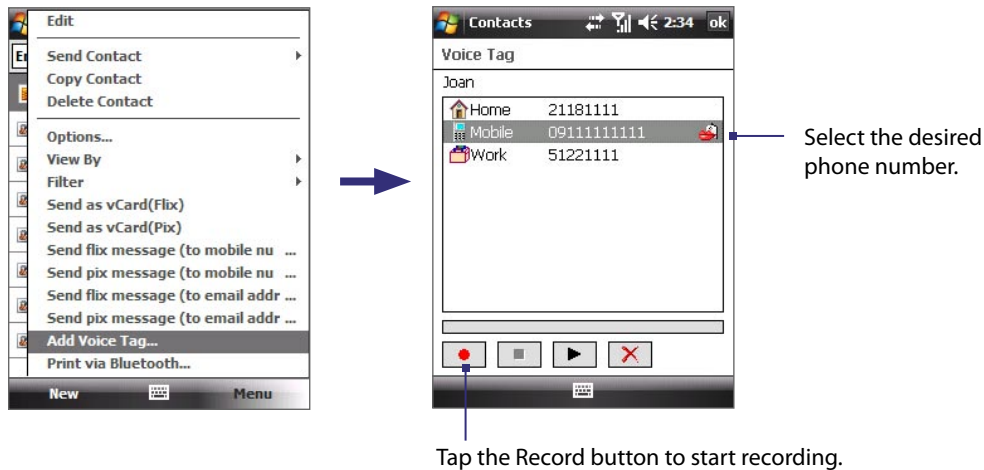

5. When you create a voice tag for the item, you can do one of the following:
  - Tap the **Record** button (  ) to rebuild the voice tag.
  - Tap the **Play** button (  ) to play the voice tag.
  - Tap the **Delete** button (  ) to delete the voice tag.

**Tip** To ensure voice recognition accuracy, please record your voice in a quiet place.

### Create a voice tag for a program



1. Tap **Start > Settings > Personal tab > Voice Speed Dial**.
2. The **Application** tab displays a list of all installed programs on the device. The procedure for creating a voice tag for a program is the same as the procedure for creating a voice tag for a phone number.
3. After you have created a voice tag for a program, you can then launch the program by saying the recorded voice tag after tapping **Start > Programs > Voice Speed Dial**.

## Make a call or launch programs using a voice tag

1. Press and hold the CAMERA button, or tap **Start > Programs > Voice Speed Dial**.
2. After a “beep” sound, say the recorded voice tag that you have assigned to the phone number you want to call or the program you want to launch. The system will repeat the voice tag and then dial out or launch the program automatically.

**Note** If the system cannot recognize your voice tag, please speak clearly and reduce the surrounding noise, then try again.

### To view and test the voice tags you have created

1. Tap **Start > Settings > Personal tab > Voice Speed Dial**.
2. The **Voice Tag** tab displays a list that contains all the voice tags you have created. Select an item in the list, and you can do one of the following:
  - Tap the **Record** button (  ) to rebuild the voice tag.
  - Tap the **Play** button (  ) to play the voice tag.
  - Tap the **Delete** button (  ) to delete the voice tag.





# Appendix

**A.1 Specifications**

**A.2 Regulatory Notices**

**A.3 Additional Safety Information**

## A.1 Specifications

System Information	
<b>Processor</b>	Qualcomm MSM7500™, 400MHz
<b>Memory</b>	- ROM : 256 MB - RAM : 128 MB DDR (Figures are the total ROM and RAM memory available for use and storage. Since the memory is shared by the Operating System, applications, and data, the actual available memory is less than what is written).
<b>Operating System</b>	Windows Mobile® 6 Professional
Power	
<b>Battery</b>	Rechargeable Lithium-ion battery, 1100 mAh
<b>Charging Time</b>	4 hours
<b>Battery Life (estimates)</b>	Standby time: Up to 250 hours Talk time: Up to 3.5 hours Media playback time: Up to 8 hours (WMV); up to 12 hours (WMA)
<b>AC Adapter</b>	Voltage range/frequency: 100 - 240V AC, 50/60 Hz DC output: 5V and 1A
Display	
<b>LCD Type</b>	2.8" TFT-LCD with backlight LEDs, touch-sensitive screen
<b>Resolution</b>	240 x 320 with 65,536 colors
<b>Alignment</b>	Portrait and Landscape
Phone	
<b>Functionality</b>	CDMA2000 1xEVDO/1xRTT and IS-95A/B voice or data
<b>Mode</b>	Dual-band (800 and 1900 MHz)
<b>Internal Antenna</b>	Yes
Physical	
<b>Dimensions</b>	101 mm (L) x 59.6 mm (W) x 14.1 mm (T)
<b>Weight</b>	112g (with battery)
Camera Module	
<b>Type</b>	2 megapixel color CMOS camera
<b>Resolution</b>	Photo: 1600x1200 (UXGA), 1280x960 (SXGA), 640x480 (VGA), 320x240 (QVGA), 160x120 (QQVGA) Video: 176x144 (QCIF), 128x96
<b>Digital Zoom</b>	Up to 8x

## Connections

**I/O Port** HTC ExtUSB™ : 11-pin mini-USB and audio jack in one  
Full-speed USB 2.0  
HTC H2Wire support  
(ExtUSB is a proprietary connection interface that is trademarked by HTC.)

**Wireless Connections** Bluetooth 2.0

**External Antenna Connector** For connecting to an external phone antenna

**GPS** Internal GPS antenna

## Controls and Lights

**Navigation Buttons**

- HTC TouchFLO™
- 5-Way NAVIGATION Control / ENTER button
- Two phone functions : TALK and END
- Volume Slider
- CAMERA button
- POWER button
- RESET button

**LEDs** The left LED shows Green and Amber lights for CDMA standby, message, and network status as well as for notification and battery charging status.  
The right LED shows a flashing Blue light when the Bluetooth system is powered up and ready to transmit Bluetooth radio signal.

## Audio

**Microphone/ Speaker** Built-in microphone and loud speaker for hands-free supported

**Codec** AMR-NB / AMR-WB / AAC / AAC+ / eAAC+ / WAV / WMA / MP3

## Expansion Slots

**Card Slot** microSD™ (SD 2.0 compatible)

---

## A.2 Regulatory Notices

### Regulatory Agency Identifications

For regulatory identification purposes, your product is assigned a model number of VOGU100.

FCC ID: NM8VOGU100. IC: 4115A-VOGU100.

To ensure continued reliable and safe operation of your device, use only the accessories listed below with your VOGU100.

The Battery Pack has been assigned a model number of ELF0160.

This product is intended for use with a certified Class 2 Limited Power Source, rated 5 Volts DC, maximum 1 Amp power supply unit.

### Federal Communications Commission Notice

This device complies with part 15 of the FCC Rules. Operation is subject to the following two conditions: (1) This device may not cause harmful interference, and (2) this device must accept any interference received, including interference that may cause undesired operation.

This equipment has been tested and found to comply with the limits for a Class B digital device, pursuant to Part 15 of the FCC Rules. These limits are designed to provide reasonable protection against harmful interference in a residential installation. This equipment generates, uses, and can radiate radio frequency energy and, if not installed and used in accordance with the instructions, may cause harmful interference to radio communications. However, there is no guarantee that interference will not occur in a particular installation. If this equipment does cause harmful interference to radio or TV reception, which can be determined by turning the equipment on and off, the user is encouraged to try to correct the interference by one or more of the following measures:

- Reorient or relocate the receiving antenna.
- Increase the separation between the equipment and receiver.
- Connect the equipment into an outlet on a circuit different from that to which the receiver is connected.
- Consult the dealer or an experienced radio or television technician for help.

### Modifications

The FCC requires the user to be notified that any changes or modifications made to the device that are not expressly approved by High Tech Computer Corporation may void the user's authority to operate the equipment.

### FCC Hearing-Aid Compatibility (HAC) Regulations for Wireless Devices

On July 10, 2003, the U.S. Federal Communications Commission (FCC) Report and Order in WT Docket 01-309 modified the exception of wireless phones under the Hearing Aid Compatibility Act of 1988 (HAC Act) to require digital wireless phones be compatible with hearing-aids. The intent of the HAC Act is to ensure reasonable access to telecommunications services for persons with hearing disabilities.

While some wireless phones are used near some hearing devices (hearing aids and cochlear implants), users may detect a buzzing, humming, or whining noise. Some hearing devices are more immune than others to this interference noise, and phones also vary in the amount of interference they generate.

The wireless telephone industry has developed a rating system for wireless phones, to assist hearing device users find phones that may be compatible with their hearing devices. Not all phones have been rated. Phones that are rated have the rating on their box or a label located on the box.

The ratings are not guarantees. Results will vary depending on the user's hearing device and hearing loss. If your hearing device happens to be vulnerable to interference, you may not be able to use a rated phone successfully. Trying out the phone with your hearing device is the best way to evaluate it for your personal needs.

M-Ratings: Phones rated M3 or M4 meet FCC requirements and are likely to generate less interference to hearing devices than phones that are not labeled. M4 is the better/higher of the two ratings. VOGU100 is rated M3.

Please power off the Bluetooth function while using hearing aid devices with your VOGU100.

Hearing devices may also be rated. Your hearing device manufacturer or hearing health professional may help you find this rating. Higher ratings mean that the hearing device is relatively immune to interference noise. The hearing aid and wireless phone rating values are then added together. A sum of 5 is considered acceptable for normal use. A sum of 6 is considered for better use. A sum of 8 is considered for best use.

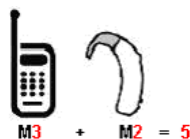

In the above example, if a hearing aid meets the M2 level rating and the wireless phone meets the M3 level rating, the sum of the two values equal M5. This should provide the hearing aid user with "normal usage" while using their hearing aid with the particular wireless phone. "Normal usage" in this context is defined as a signal quality that is acceptable for normal operation.

The M mark is intended to be synonymous with the U mark. The T mark is intended to be synonymous with the UT mark. The M and T marks are recommended by the Alliance for Telecommunications Industries Solutions (ATIS). The U and UT marks are referenced in Section 20.19 of the FCC Rules. The HAC rating and measurement procedure are described in the American National Standards Institute (ANSI) C63.19 standard.

**For information about hearing aids and digital wireless phones**

FCC Hearing Aid Compatibility and Volume Control:

<http://www.fcc.gov/cgb/dro/hearing.html>

Gallaudet University, RERC:

<http://tap.gallaudet.edu/DigWireless.KS/DigWireless.htm>

## SAR Information

### SAR: 1.250 W/kg @1g (USA)

THIS MODEL DEVICE MEETS THE GOVERNMENT'S REQUIREMENTS FOR EXPOSURE TO RADIO WAVES.

For body worn operation, this phone has been tested and meets the FCC RF exposure guidelines when used with the High Tech Computer Corp. accessories supplied or designated for this product. Use of other accessories may not ensure compliance with the FCC RF exposure guidelines.

Your wireless mobile CDMA phone is a radio transmitter and receiver. It is designed and manufactured not to exceed the emission limits for exposure to radio frequency (RF) energy set by the Federal Communications Commission of the U.S. Government. These limits are part of comprehensive guidelines and establish permitted levels of RF energy for the general population. The guidelines are based on the safety standards previously set by both U.S. and international standards bodies:

- American National Standards Institute (ANSI) IEEE. C95.1-1992.
- National Council on Radiation Protection and Measurement (NCRP). Report 86. 1986.
- International Commission on Non-Ionizing Radiation Protection (ICNIRP) 1996.
- Ministry of Health (Canada), Safety Code 6. The standards include a substantial safety margin designed to assure the safety of all persons, regardless of age and health.

The exposure standard for wireless mobile CDMA phone employs a unit of measurement known as the Specific Absorption Rate, or SAR. The SAR limit set by the FCC is 1.6 W/kg\*.

The FCC has granted an Equipment Authorization for this model device with all reported SAR levels evaluated as in compliance with the FCC RF exposure guidelines. SAR information on this model device is on file with the FCC and can be found under the Display Grant section of <https://gulfoss2.fcc.gov/prod/oet/cf/eas/reports/GenericSearch.cfm> after searching on FCC ID: NM8VOGU100. Additional information on Specific Absorption Rates (SAR) can be found on the Cellular Telecommunications & Internet Association (CTIA) Web-site as <http://www.phonefacts.net>.

Additional information on Specific Absorption Rates (SAR) can be found on the Cellular Telecommunications & Internet Association (CTIA) Web-site as <http://www.phonefacts.net>.

\* In the U.S. and Canada, the SAR limit for mobile CDMA phone used by the public is 1.6 Watts/kg (W/kg) averaged over one gram of tissue. The standard incorporates a substantial margin of safety to give additional protection for the public and to account for any variations in usage.

Normal condition only to ensure the radiative performance and safety of the interference. As with other mobile radio transmitting equipment, users are advised that for satisfactory operation of the equipment and for the safety of personnel, it is recommended that no part of the human body be allowed to come too close to the antenna during operation of the equipment.

## IC Statement

Operation is subject to the following two conditions:

1. This device may not cause interference; and
2. This device must accept any interference, including interference that may cause undesired operation of the device.

## Important Note

IC Radiation Statement:

This equipment complies with IC radiation exposure limits set forth for an uncontrolled environment. End users must follow the specific operating instructions for satisfying RF exposure compliance.

This Class B digital apparatus complies with Canadian ICES-003.

## Telecommunications & Internet Association (TIA) Safety Information

### Pacemakers

The Health Industry Manufacturers Association recommends that a minimum separation of six inches be maintained between a handheld wireless phone and a pacemaker to avoid potential interference with the pacemaker. These recommendations are consistent with the independent research by and recommendations of Wireless Technology Research. Persons with pacemakers:

- Should ALWAYS keep the phone more than six inches from their pacemaker when the phone is turned ON.
- Should not carry the phone in a breast pocket.
- Should use the ear opposite the pacemaker to minimize the potential for interference. If you have any reason to suspect that interference is taking place, turn the phone OFF immediately.

### Hearing Aids

Some digital wireless phones may interfere with some hearing aids. In the event of such interference, you may want to consult your service provider, or call the customer service line to discuss alternatives.

## Other Medical Devices

If you use any other personal medical device, consult the manufacturer of your device to determine if it is adequately shielded from external RF energy. Your physician may be able to assist you in obtaining this information.

Turn the phone OFF in health care facilities when any regulations posted in these areas instruct you to do so. Hospitals or health care facilities may be using equipment that could be sensitive to external RF energy.

## WEEE Notice

The Directive on Waste Electrical and Electronic Equipment (WEEE), which entered into force as European law on 13th February 2003, resulted in a major change in the treatment of electrical equipment at end-of-life.

The purpose of this Directive is, as a first priority, the prevention of WEEE, and in addition, to promote the reuse, recycling and other forms of recovery of such wastes so as to reduce disposal.



The WEEE logo (shown at the left) on the product or on its box indicates that this product must not be disposed of or dumped with your other household waste. You are liable to dispose of all your electronic or electrical waste equipment by relocating over to the specified collection point for recycling of such hazardous waste. Isolated collection and proper recovery of your electronic and electrical waste equipment at the time of disposal will allow us to help conserving natural resources. Moreover, proper recycling of the electronic and electrical waste equipment will ensure safety of human health and environment. For more information about electronic and electrical waste equipment disposal, recovery, and collection points, please contact your local city centre, household waste disposal service, shop from where you purchased the equipment, or manufacturer of the equipment.

## RoHS Compliance

This product is in compliance with Directive 2002/95/EC of the European Parliament and of the Council of 27 January 2003, on the restriction of the use of certain hazardous substances in electrical and electronic equipment (RoHS) and its amendments.

## A.3 Additional Safety Information

This section provides more safety information in addition to the information at the beginning of the user manual.

### When Driving

#### Do Not Use The PC Functions Of Your Pocket PC While Driving Or Walking

Never use the personal computer functions of your device while driving an automobile or any other moving vehicle. Always pull out of traffic and come to a stop in a legally permissible and safe location before using your device. Failure to do so could result in serious bodily injury in a traffic accident.

When driving:

- Always secure your device in its leather pouch.
- Never place your device on the passenger seat or anyplace else in the car where it can become a projectile during a collision or stop.
- An air bag inflates with great force. DO NOT place objects, including either installed or portable wireless equipment, in the area over the air bag or in the air bag deployment area. If in-vehicle wireless equipment is improperly installed and the air bag inflates, serious injury could result.

Never store or transport flammable liquids, gases or explosive materials in the same compartment of your automobile as the device or any of its accessories, as possible sparking in the device could cause ignition or explosion.

Never use your device while walking. Usage while walking could result in bodily injury caused by inattention to automobile traffic or other pedestrian hazards.

#### Using The Phone Function Of Your Pocket PC While Driving Is Extremely Dangerous

Talking on or using your device while driving is extremely dangerous and is illegal in some states. Remember, safety comes first. Check the laws and regulations on the use of phones in the areas where you drive. Always obey them.

If you must use the phone function while driving, please:

- Give full attention to driving. Driving safely is your first responsibility.
- Use hands-free operation and/or one-touch, speed dialing, and auto answer modes.
- Pull off the road and park before making or answering a call.

**WARNING:** Failure to follow these instructions could lead to serious personal injury and possible property damage.

### When Using Your Device Near Other Electronic Devices

Your wireless handheld portable device is a low power radio transmitter and receiver. When it is ON, it receives and also sends out radio frequency (RF) signals.

Most modern electronic equipment is shielded from RF energy. However, certain electronic equipment may not be shielded against the RF signals from your wireless device; therefore, use of your device must be restricted in certain situations.

In addition, the computer portion of your device produces low levels of RF energy due to the generation of digital timing pulses by its clock oscillator circuits. Your device has been equipped with internal shielding to minimize stray emissions of RF energy. However, use of the computer functions of your device must be restricted in certain situations.



## PACEMAKERS

The Health Industry Manufacturers Association recommends that a minimum separation of six (6") inches be maintained between a handheld wireless phone and a pacemaker to avoid potential interference with the pacemaker. These recommendations are consistent with the independent research by and recommendations of Wireless Technology Research.

Never come closer than six (6) inches to a person with a heart pacemaker implant when using your device. Doing so could result in interference with the function of the pacemaker.

Persons with pacemakers:

- Should ALWAYS keep the phone more than six inches from their pacemaker when the phone is turned ON.
- Should not carry the phone in a breast pocket.
- Should use the ear opposite the pacemaker to minimize the potential for interference.  
**Note:** This is not necessary if the device is not held to the ear.
- If you have any reason to suspect that interference is taking place, turn the phone OFF immediately.

## HEARING AIDS

Some digital wireless phones may interfere with some hearing aids. In the event of such interference, you may want to consult your service provider, or call the customer service line to discuss alternatives.

For more regulatory information about hearing devices, see "FCC Hearing-Aid Compatibility (HAC) Regulations for Wireless Devices".

## OTHER MEDICAL DEVICES

If you use any other personal medical device, consult the manufacturer of your device to determine if it is adequately shielded from external RF energy. Your physician may be able to assist you in obtaining this information.

## HOSPITALS AND HEALTH CARE FACILITIES

Turn your device OFF in health care facilities when any regulations posted in these areas instruct you to do so. Hospitals or health care facilities may be using equipment that could be sensitive to external RF energy.

## ELECTRONIC DEVICES IN VEHICLES

RF signals may affect improperly installed or inadequately shielded electronic systems in motor vehicles. Check with the manufacturer or its representative regarding your vehicle. You should also consult the manufacturer of any equipment that has been added to your vehicle.

## POSTED FACILITIES

Turn your device OFF where posted notices so require.

## Turn Off Your Device Before Flying

### AIRCRAFT

FCC regulations prohibit using the transmitting and phone functions of your device while in the air. In addition, most airline regulations prohibit the on-board use of portable PCs (and all other portable electronic devices that could potentially emit stray RF energy), particularly during take-offs and landings, to prevent any possible interference with the reception of signals by airborne electronic navigational devices.

Turn your device OFF before boarding an aircraft. Always request and obtain prior consent and approval of an authorized airline representative before using your device aboard an aircraft. Always follow the instructions of the airline representative whenever using your device aboard an aircraft, to prevent any possible interference with airborne electronic equipment.

## Turn Off Your Device in Dangerous Areas

### BLASTING AREAS

To avoid interfering with blasting operations, turn your device OFF when in a “blasting area” or in areas posted “Turn off two-way radio”. Obey all signs and instructions.

### POTENTIALLY EXPLOSIVE ATMOSPHERES

Turn your device OFF when in any area with a potentially explosive atmosphere and obey all signs and instructions. Sparks in such areas could cause an explosion or fire resulting in bodily injury or even death.

Areas with a potentially explosive atmosphere are often, but not always, clearly marked. They include fuelling areas such as gas stations; below deck on boats; fuel or chemical transfer or storage facilities; vehicles using liquefied petroleum gas (such as propane or butane); areas where the air contains chemicals or articles, such as grain, dust, or metal powders; and any other area where you would normally be advised to turn off your vehicle’s engine.

## General Safety

Your pocket PC is a high quality piece of equipment. Before operating, read all instructions and cautionary markings on the product, battery and adapter/charger.

Failure to follow the directions below could result in serious bodily injury and/or property damage due to battery liquid leakage, fire or rupture.

DO NOT use or store this equipment in a place where it will be exposed to high temperatures, such as near an open flame or heat-emitting equipment.

DO NOT drop your device or subject it to severe shock. When not using, lay down the unit to avoid possible damage due to instability.

DO NOT expose this equipment to rain or spilled beverages.

DO NOT use unauthorized accessories.

DO NOT disassemble the device or its accessories. If service or repair is required, return unit to an authorized cellular service centre. If the unit is disassembled, the risk of electric shock or fire may result.

Never allow metallic objects, such as staples and paper clips, to get into the inside of your device.

Never touch the liquid that might leak from a broken liquid crystal display. Contact with this liquid could cause a skin rash. If the crystal display liquid should come into contact with the skin or clothing, wash it immediately with clean water.

In the event that the device emits an unusual odour or sound or generates smoke, immediately disconnect the AC adapter from the power outlet, then detach the battery.

## Antenna Safety

Use only the supplied or an approved replacement antenna. Unauthorized antennas, modifications, or attachments could impair call quality, damage your device, or result in violation of FCC regulations. Please contact your local dealer for replacement antenna.

Do not use the device with a damaged antenna. If a damaged antenna comes into contact with the skin, a minor burn may result. Please contact your local dealer for replacement antenna.

## Battery Safety

Your device uses a removable and rechargeable lithium ion battery. Please contact customer service for assistance should you need a replacement battery.

### DOs

- Only use the battery and charger approved by the manufacturer.
- Only use the battery for its original purpose.
- Try to keep batteries in a temperature between 41°F (5°C) and 95°F (35°C).
- If the battery is stored in temperatures above or below the recommended range, give it time to warm up or cool down before using.
- Completely drain the battery before recharging. It may take one to four days to completely drain.
- Store the discharged battery in a cool, dark, and dry place.
- Purchase a new battery when its operating time gradually decreases after fully charging.
- Properly dispose of the battery according to local regulations.

### DON'Ts

- Don't attempt to disassemble the battery – it is a sealed unit with no serviceable parts.
- Don't expose the battery terminals to any other metal object (e.g., by carrying it in your pocket or purse with other metallic objects such as coins, clips and pens). This can short circuit and critically damage the battery.
- Don't leave the battery in hot or cold temps. Otherwise, it could significantly reduce the capacity and lifetime of the battery.
- Don't dispose of the battery into a fire.

Lithium ion batteries are recyclable. When you replace the removable battery, please request the repair centre to recycle the battery in accordance with RBRC standards. When disposing of the battery by yourself, please call RBRC at (800) 822-8837 for proper disposal tips.

Never touch any fluid that might leak from the built-in battery. Such liquid when in contact with the eyes or skin, could cause injury to the skin or eyes. Should the liquid come into contact with the eyes, irrigate the eyes thoroughly with clean water and immediately seek medical attention. In the event the liquid comes into contact with the skin or clothing, wash it away immediately with clean water.

## Adapter/Charger

### Use the Correct External Power Source

A product should be operated only from the type of power source indicated on the electrical ratings label. If you are not sure of the type of power source required, consult your authorized service provider or local power company. For a product that operates from battery power or other sources, refer to the operating instructions that are included with the product.

The AC Adapter/Charger designed for this unit requires the use of a standard 120 V AC power source for device operation.

Never attempt to disassemble or repair an AC adapter/charger. Never use an AC adapter/charger if it has a damaged or worn power cord or plug. Always contact an authorized service centre, if repair or replacement is required.

Never alter the AC cord or plug on an AC adapter/charger. If the plug will not fit into the available outlet, have a proper outlet installed by a qualified electrician.

Never allow any liquids or water to spill on an AC adapter/charger when it is connected to an AC power source.

Always use the authorized AC adapter/charger to avoid any risk of bodily injury or damage to your cellular phone or battery.

Never attempt to connect or disconnect the AC adapter/charger with wet hands. Always unplug the AC adapter/charger from the power source before attempting any cleaning. Always use a soft cloth dampened with water to clean the equipment, after it has been unplugged.

Handling the cord on this product or cords associated with accessories sold with this product, will expose you to lead, a chemical known to the State of California to cause birth defects or other reproductive harm. Wash hands after handling.

Always disconnect the travel charger or desktop charger from the power source when it is not in use.

# Index

## A

- A2DP 109
- ActiveSync
  - copy files 99
  - install 60
  - overview 30
  - set up 60
  - synchronize with Exchange Server 86
  - synchronize with PC 61
- Add and remove programs 136
- Adobe Reader LE 97
- Alarm 51
- Answer/end a call 44
- Appointment search 40
- Attachment
  - add to e-mail 81
  - download 81

## B

- Backlight 50
- Basic settings 50
- Battery
  - battery information 17
  - save battery power 140
- Beam information using Bluetooth 109
- Block Recognizer 39
- Bluetooth
  - Bluetooth Explorer 30, 110
  - Bluetooth file sharing 110
  - Bluetooth shared folder 110
  - hands-free headset 109
  - modes 108
  - overview 108
  - partnership (pairing) 108
  - stereo headset 109
  - synchronise 62
  - visible 108
- Burst capture mode 120
- Button controls and LEDs 147

## C

- Calculator 30
- Calendar 30, 66
- Calendar search 40
- Calibration 20
- Camera
  - capture modes 120
  - controls 121
  - file formats 121
  - icons 121
  - overview 30

- settings 123
- specifications 146
- Clear Storage 138
- Clock & Alarms 32, 50
- Comm Manager 30, 33, 104
- Company Directory 91
- Conference call 45
- Contacts 30, 64
- Contacts Picture capture mode 120
- Contacts search 40
- Cookies 107
- Copy
  - files between device and PC 99
  - files to storage card 99
  - media files from PC to device 131
- Customize
  - Start menu 53
  - Today screen 52

## D

- Device ID 51
- Device name 51
- Digitally sign messages 92
- Digital signature
  - sign and encrypt 92
  - verify 92
- Dimensions and weight 146
- Direct Push 87
- Download e-mail 82
- Draw 69

## E

- E-mail
  - IMAP4 78
  - mail server settings 79
  - POP3 78
  - search 40
  - security 92
  - send 80
  - settings (POP3/IMAP4) 79
  - setup wizard 78
  - types of e-mail accounts 78
- Edit picture 129
- Emergency call 47
- Encrypt messages 92
- Encrypt storage card 55
- Excel Mobile 30, 96
- Exchange Server 87

## F

- Favorites (Internet Explorer) 106
- Favorite contacts 26

File Explorer 30  
 Find contact  
   - Company Directory 91  
   - on device 65  
 Finger panning 27  
 Finger scrolling 27

## G

Games 30  
 Get Applications 30  
 GIF animation 129

## H

Hard reset 138  
 Help 30  
 Help search 40  
 Home 23  
 Home page (Internet Explorer) 106  
 HTC Home 22

## I

IMAP4 78  
 Input methods  
   - Block Recognizer 39  
   - Letter Recognizer 38  
   - Transcriber 39  
 Input Panel 36  
 Internet Explorer Mobile 30, 106  
 Internet security settings 107

## L

Landscape 20  
 Launcher 24, 27  
 Letter Recognizer 38  
 Library screen (Windows Media Player Mobile) 131

## M

Mail search 40  
 Make call  
   - from Call History 43  
   - from Contacts 43  
   - from Phone program 43  
   - from Speed Dial 44  
   - from TouchFLO 43  
 Memory 139, 146  
 Messaging  
   - about 30, 72  
   - e-mail 78, 80  
   - MMS 74  
   - text (SMS) 73  
 Microsoft Office Mobile 30  
 MMS  
   - add audio clip 77  
   - add photo/video 76  
   - add text 76  
   - create and send 76

  - MMS settings 75  
   - overview 74  
   - reply message 77  
   - view message 77  
 MMS Video 120  
 Modem Link 30  
 Multimedia 27, 130  
 Music playback  
   - TouchFLO 27  
   - Windows Media Player Mobile 130  
 Mute 45

## N

Notes 30, 69  
 Notes search 40  
 Now Playing screen (Windows Media Player Mobile) 131

## O

Office Mobile 30  
 On-screen Keyboard 36  
 Open PDF file 97  
 Owner information 52

## P

PDF 97  
 Phone 30, 42, 43  
 Photo capture mode 120  
 Pictures & Videos  
   - edit picture 129  
   - file formats 128  
   - overview 31  
   - play GIF animation 129  
   - play videos 129  
 Picture Theme capture mode 120  
 Playback screen (Windows Media Player Mobile) 131  
 Playlists 132  
 Play GIF animation 129  
 Play media 132  
 Play music  
   - Touch Cube (TouchFLO) 27  
   - Windows Media Player Mobile 130  
 Play videos 129  
 POP3 78  
 Portrait 20  
 PowerPoint Mobile 30  
 Programs 30  
   - Excel Mobile 96  
   - PowerPoint Mobile 97  
   - Word Mobile 96  
   - ZIP 100  
 Put call on hold 45

## Q

Quick menu 22

**R**

Receive call 44  
 Record  
   - voice note 69  
   - voice recording 70  
 Regional settings 50  
 Regulatory notices 148  
 Reply e-mail 82  
 Reply MMS 77  
 Reset  
   - clear storage 138  
   - hard reset 137  
   - soft reset 137  
 Review screen (Camera) 123  
 Ring tone 51  
 Ring type 51  
 Running Programs 31

**S**

Save picture from Web page 107  
 Screen text size 50  
 Search 31, 40  
 Secure/Multipurpose Internet Mail Extension (S/MIME) 92  
 Security settings (Internet Explorer) 107  
 Send  
   - e-mail 80  
   - text message (SMS) 73  
 Settings 50  
   - camera 123  
 Settings (Connections tab)  
   - Beam 33  
   - Bluetooth 33, 108  
   - Comm Manager 33, 104  
   - Connections 33  
   - Network Cards 33  
   - USB to PC 33, 61  
 Settings (Personal tab)  
   - Buttons 31  
   - Input 31  
   - Lock 31, 55  
   - Menus 31, 53  
   - Owner Information 31, 52  
   - Phone 31, 51  
   - Sounds & Notifications 31, 52  
   - Today 31, 52  
   - Voice Speed Dial 31  
 Settings (System tab)  
   - About 32, 51  
   - Backlight 32, 50  
   - Certificates 32  
   - Clear Storage 32, 138  
   - Clock & Alarms 32, 50, 51  
   - Customer Feedback 32  
   - Device Information 32  
   - Encryption 32, 55  
   - Error Reporting 32  
   - External GPS 32  
   - Key Lock 32  
   - Memory 32, 139  
   - Power 20, 32, 140  
   - Regional Settings 32, 50  
   - Remove Programs 32, 136  
   - Screen 20, 32, 50  
   - Task Manager 32, 136  
   - TouchFLO 29, 32  
 Shortcuts 24, 27  
 Smart Dialing 46  
 SMS 73  
 Soft reset 137  
 Sound 25  
 Sounds & Notifications 52  
 Speakerphone 45  
 Specifications 146  
 Speed Dial 44  
 Sports capture mode 120  
 Start menu 22, 53  
 Status icons 21  
 Storage card  
   - check available space 139  
   - copy files 100  
   - encrypt 55  
   - install 19  
 Swap/switch calls 45  
 Synchronize  
   - ActiveSync 61  
   - change information types 61  
   - via Bluetooth 62  
   - Windows Media Player 62, 131  
   - with computer 61  
   - with Exchange Server 86  
 System information 146

**T**

Tasks 31, 68  
 Tasks search 40  
 Task Manager 136  
 Temporary Internet files 107  
 Text messages 73  
 Text Messages Retry 31  
 Text size (screen) 50  
 Text size on Web pages 106  
 Today screen 21, 52  
 TouchFLO 25, 32, 43  
 Touch Cube (TouchFLO) 25  
 Transcriber 39  
 Troubleshoot  
   - sync connection 61  
   - Windows Media Player Mobile 133  
 Turn device on and off 20  
 Turn phone function on and off 42

**U**

USB to PC 61

## V

- Verify digital signature 92
- Vibrate 42, 51
- Video capture mode 120
- View
  - MMS 77
- View pictures 129
- Voicemail 44
- Voice call 43
- Voice Recorder 31, 69, 70
- Voice Speed Dial
  - create
  - voice tag for phone number 142
  - voice tag for program 142
  - make call or launch program 143
  - overview 31, 142
- Voice Speed Dial Switch 31
- Voice tag
  - create
  - for phone number 142
  - for program 142
  - make call or launch program 143
- Volume 42

## W

- Weather 23
- Web pages
  - layout 107
  - text size 106
- Windows Media Player Mobile
  - file formats 130
  - menus 131
  - overview 31
  - troubleshoot 133
- Windows Mobile Device Center 58
- Windows Update 32, 139
- Wireless Sync 31
- Word Mobile 30

## Z

- ZIP
  - create archive 101
  - open zip file and extract files 100
  - overview 31, 100
- Zoom (Camera) 122