

Mamiya

RZ67 PROFESSIONAL IID

Instructions

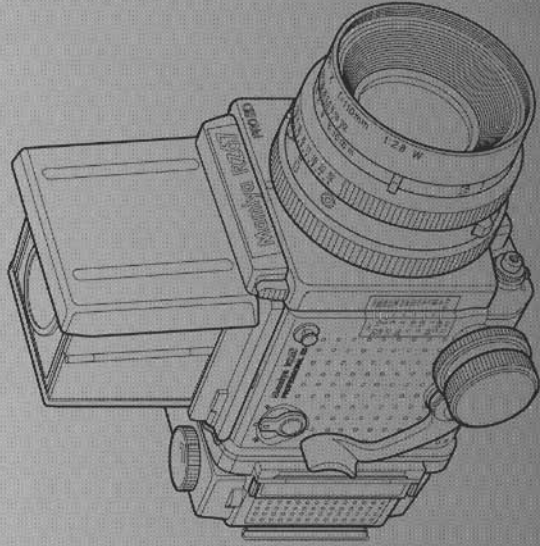

For proper use of the camera

- In order to prevent injury to you or others read the "Safety precautions" thoroughly.
 - The symbols used in this manual and their meanings are as follows.
- ⚠ WARNING**... A WARNING calls attention to a procedure, practice, condition or the like, which, if not correctly performed or adhered to, could result in serious injury or death.
- ⚠ CAUTION**... A CAUTION calls attention to a procedure, practice, condition or the like, which, if not correctly performed or adhered to, could result in injury to people and may damage or destroy property.
- Precautions: These items contain important safety descriptions. Make sure to follow the advice.

⚠ WARNING

- Store the batteries and small accessories out of the reach of infants and small children. If they are swallowed, contact a physician immediately.
- Store the camera out of the reach of infants and small children. They might wind the strap on the camera around their necks.
- If you detect an abnormality with the camera, such as generating heat, smoke, or a burning smell, stop using it immediately. Remove the batteries from the camera. Otherwise, a fire may break out or you may burn your skin. If removing the batteries because of an abnormal condition, do not touch them with your bare hands.

⚠ CAUTION

- Do not let the batteries' terminals ("+" and "-") come into contact with metal objects or carry or store batteries together with metal hair pins, chains, paper clips or other metal objects.
- When storing and disposing of batteries, insulate (apply tape to) the batteries' terminals ("+" and "-") so that they do not come into contact with metal objects or other batteries.
- Do not charge the batteries, take them apart, apply pressure to them, heat them or dispose of them in flames.
- Do not use new batteries together with used ones or mix batteries of different manufacturers or types.
- Do not bang or drop the camera. The camera may break and you may be injured by the broken parts. If it is banged or dropped, stop using it.
- Remove spent batteries from the camera immediately.
- Use a tripod providing sufficient strength for the camera and lens. Also do not transport the camera with it mounted on a tripod. Doing so could damage the camera or cause you to trip, resulting in injury or other accidents.
- Be sure to fasten the neck strap securely to the camera's strap mount. Failure to do so may result in the camera falling, causing injury or damage to the product.
- Do not look directly at the sun or strong light sources through the lens. Doing so could impair your vision.
- Put a cap on the Lens. Without the cap, sunlight can enter through the Lens and will be focused. This could cause a fire.
- Do not lift or hold the camera by the viewfinder. The viewfinder may break or the camera may fall, you could be injured or the camera may be damaged.
- Do not disassemble. Internal electrical circuitry may cause electric shocks if touched.
- Do not use the camera for purposes other than taking pictures.

Introduction

Congratulations on your purchase of the Mamiya RZ67PRO IID and welcome to the world-wide family of happy Mamiya camera owners!

The Mamiya RZ67PRO IID is a 6 x 7 cm format single-lens reflex camera with a lens shutter on which is installed a revolutionary Rotating Back.

Complemented by its large selection of world-class Mamiya lenses, and many other system accessories, the RZ67 has become the camera of choice by the world's top photographers. The RZ67PRO IID is a versatile camera, ideally suited to many photographic applications, including commercial portraits, fashion, industrial documentation, nature and scientific photography.

Also, the Digital Back accessory for the RZ67PRO IID is compatible with Mamiya's special Digital Control System, so it can expand the applications of this camera for both film and digital work.

In order to take full advantage of its capabilities, and to insure proper operation, please read this instruction manual carefully before you use the camera. After reading the manual, store it in a handy location for further reference.

This manual gives general instructions for normal uses of the camera. However, the manual may not cover some uses of the camera when combined with other systems. In such cases, read the user's manual for each system and reread this manual.

Features of the RZ67PRO IID

- 1 Versatile range of lenses available from wide angle to telephotography.
- 2 Mirror-up and multiple exposure functions.
- 3 Rotating back that can change the view between horizontal and vertical.
- 4 Bellows extension focal adjustment mechanism (double focal point adjustment mechanism equipped with a fine feed knob)
- 5 Strobe flash is synchronized at all shutter speeds.
- 6 Intermediate shutter speeds can be used.
- 7 LED indicators in the viewfinder and an audible alarm.
- 8 Mamiya Digital Communication System creates the optimum conditions between the camera and the digital back.

In order to combine camera functions with digital processing, the RZ67PRO IID employs the MSCF™ communication standard. Using this serial protocol the camera can operation of the camera and digital back can be optimized, producing state-of-the-art, ultra high pixel, neutral control, digital imaging technology.

Ⓜ Mamiya External Serial Communication standard, or MSCF is Mamiya's proprietary digital communication standard for communicating data directly between the camera and the digital back.

Names of Each Parts

Body

Focusing Screen

(P56)

Gold Plated Contacts

R-M Lever

(P31)

Alignment Mark

Cocking Lever

(P18, 19
36, 41)

Distance Scale

(P49, 51)

Focal Length Scale

(P49, 51)

Dual Focusing Knob

(P38, 41)

Release Button Collar

(P30)

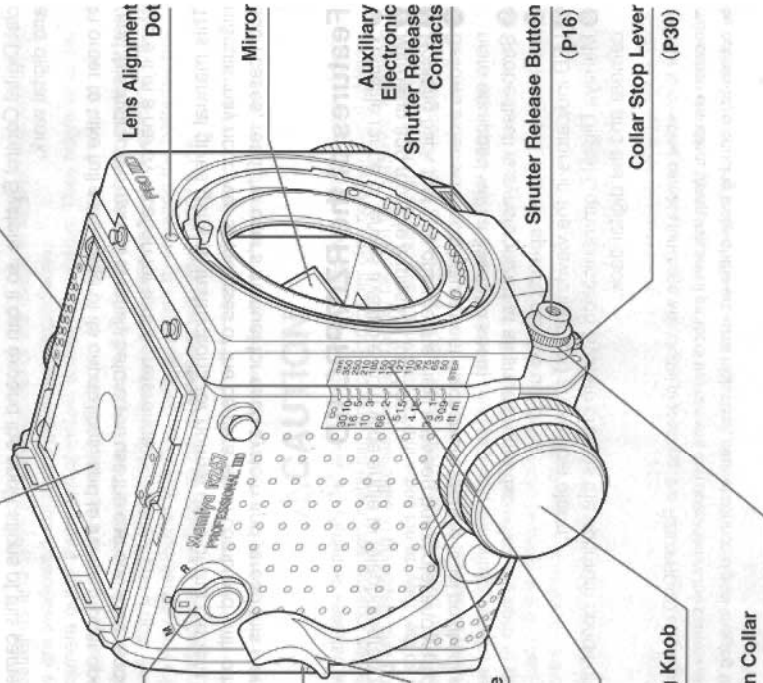

Outer Cassette

Film Speed Dial

(P21, 22)

Shutter Speed Dial

(P21, 22)

Carrying Strap Lug

(P55)

Lock Release Button

(P21)

Hot-Shoe

Focusing Knob Lock Lever

(P38)

Winder Coupler Cover

(P9, 13)

Tripod Socket

(P50)

Roll film holder contacts

(P23, 31)

Alignment Mark

(P27)

Revolving Ring

Film Advance Coupler

Light Baffle

Film Holder Mount Pin

One of four (P9, 28)

Battery Chamber Cover

(P9, 13)

Contacts for Power Winder

Contacts for the Digital Pack

Roll Film Holder

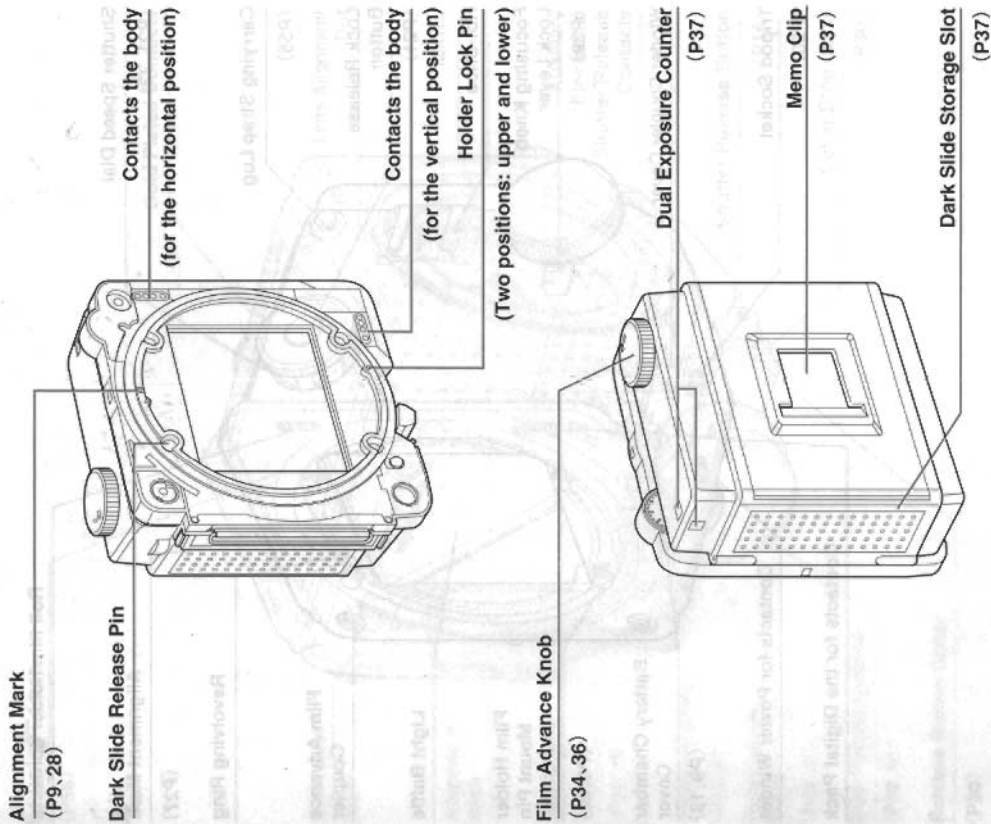

Outer cassette

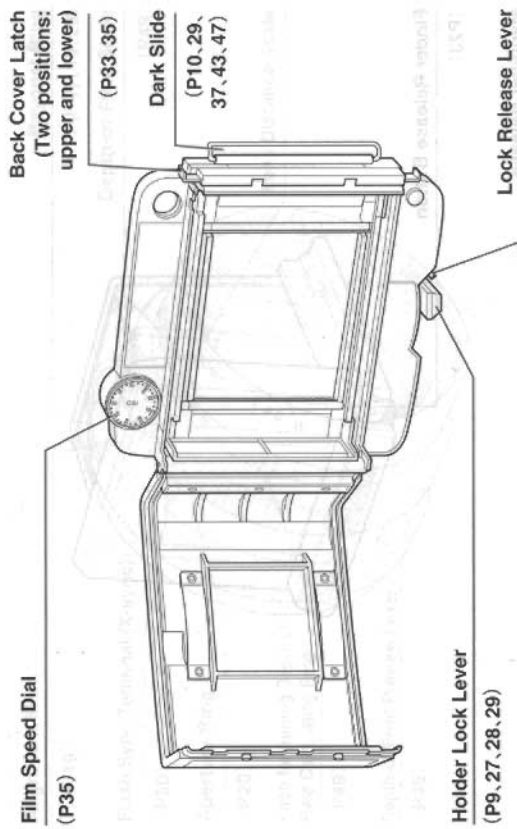

Film insert

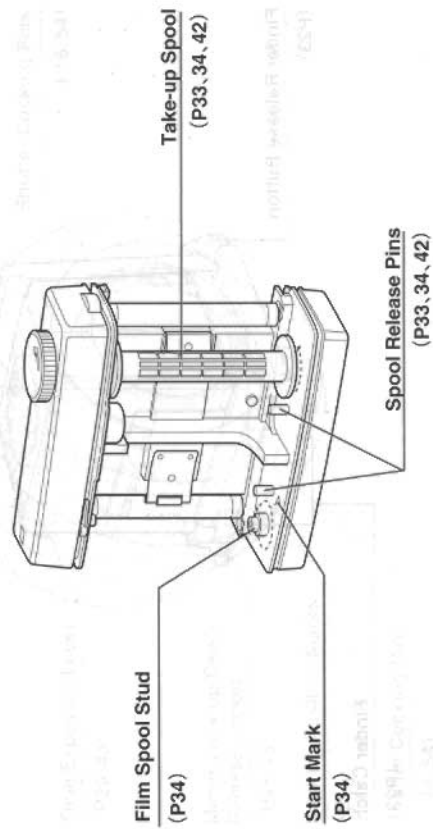

Waist-Level Finder

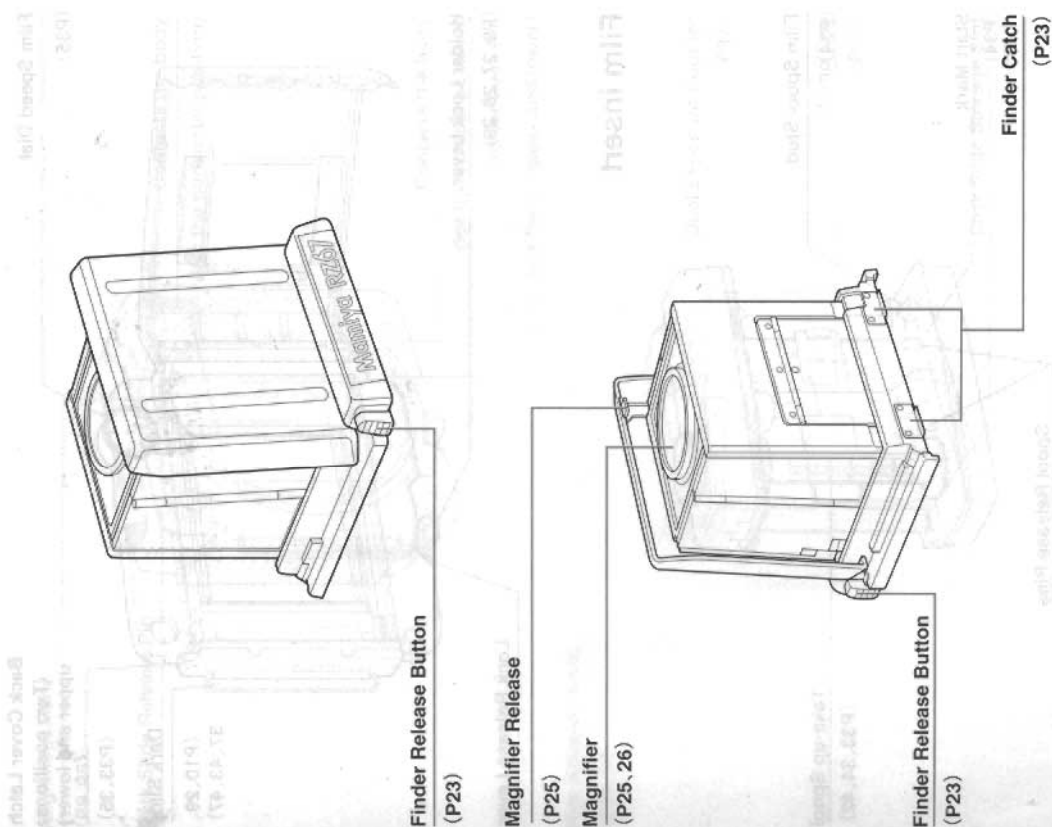

Lens

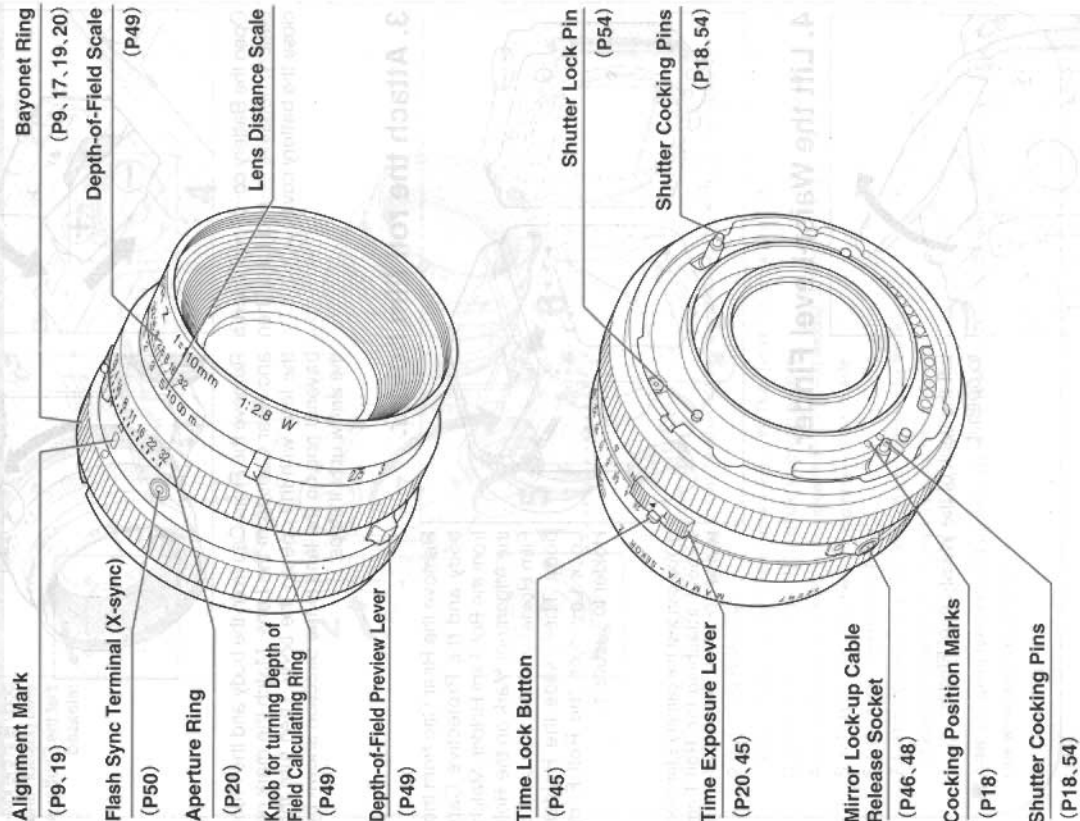

Camera operation test

1. Insert a battery

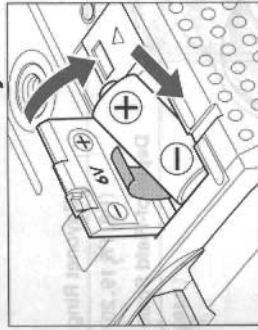

※Make sure that the Mirror on the body is in the lowered position and that the Shutter is released.

2. Attach the lens



Open the Battery cover and insert a battery, negative \ominus end first. Then close the battery cover.

Remove the Front Cap from the body and the Front and Rear Caps from the Lens. Match the mark on the lens with the one on the body. Then turn the bayonet ring on the lens in the direction shown by the arrow until it stops.

3. Attach the roll film holder.

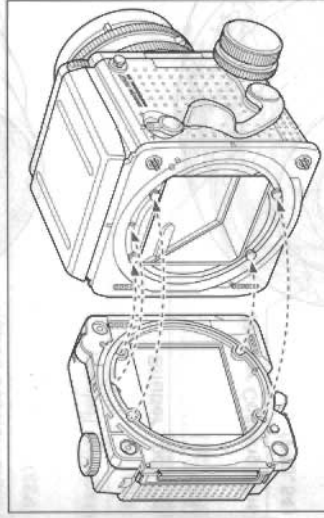

Remove the Rear Cap from the body and the Protective Cap from the Roll Film Holder. Match the Alignment Mark on the Roll Film Holder with the one on the body. Then, slide the Holder Lock Lever on the Roll Film Holder to secure it.

※You can test the camera's function without attaching the Roll Film Holder.

4. Lift the Waist-Level Finder.

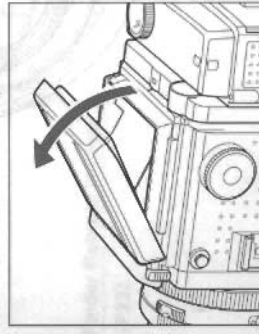

Lift the back of the Waist-Level Finder to open it.

It is best to become acquainted with the method for releasing the shutter before using film in the camera.

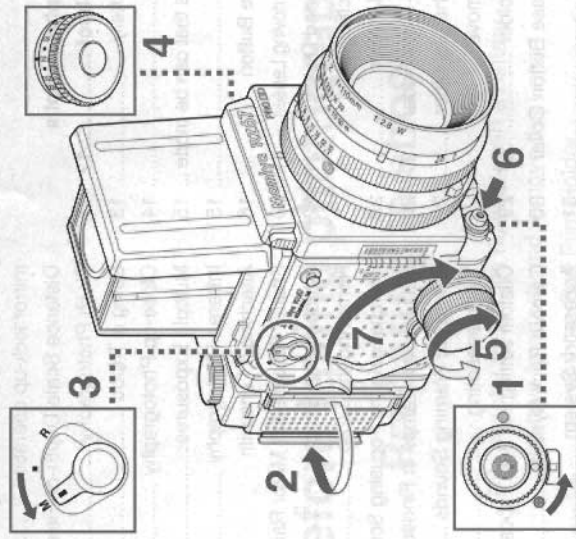

[Attach the Lens and Roll Film Holder to the body.]

1. Rotate the Shutter Selector Ring so that the white dot on it is aligned with the white square just below.
2. Pull out the Dark Slide.

(You can test operation of the camera even if the Roll Film Holder is not attached.)

3. Set the R-M Lever to the "M" (multiple exposure) position.
4. Set the Shutter Speed Dial to any speed from B to 1/400 second, but do not use "AEF" or "RBL."
5. Adjust the focus using the Focusing Knobs on either side.
6. Press the Shutter Release Button.
7. Push the Cocking Lever all the way down to prepare for the next shot.

(Since this camera does not employ a quick return system, the Mirror left raised. Set the Shutter and Mirror.)

■ After you complete test shot above, return the R-M Lever to its normal position (the white square position).

For proper use of the camera	1	Taking photographs	44~66
Introduction	2	Long Exposures	45
Names of Each Parts	3~8	Mirror Lock-up Operation	46
Camera operation test	9~10	How to stop mirror lock-up operation	47~48
Before taking photographs		Distance Scale/Depth-of-Field	49
Preparing to shoot	12~31	Flash Photography	50
Loading the Battery	13	Using a Tripod	50
Battery Check	14	Close-up Photography	51~52
Number of shots that can be made ...	15	Multiple Exposures	53
Batteries Care	15	Infrared Photography	53
Shutter Release Button	16	Attaching a Lens with Shutter Released or Mirror Raised ...	54
Attaching and Removing Lenses ...	17~20	Attaching the Strap	55
The Shutter Speed Dial	21~22	Removing the Strap	55
Removing/Attaching the Waist-Level Finder	23	Interchanging the Focusing Screen ...	56
Using the Waist-Level Finder ...	24~25	LED Monitor Lamps in Finder	57
Interchanging the Magnifier	26	Electronic Warning Sounds	58
To attach or remove the Roll Film Holder	27~29	Troubleshooting	59
Using the Release Button Collar ...	30	Custom setting the Bulb Exposure ...	60
The R-M Lever	31	Camera Pack System	61
Taking photographs	32~43	Accessory System	62~64
Loading the Film Holder	33~35	When using accessories for RZ67PRO ...	65
Advancing the Film	36~37	Using RB Series Lenses and Accessories ...	66
Focusing and Locking the Focusing Knob ...	38	Mamiya RZ67 PRO IID Specifications ...	67~68
The Revolving Back	39~40	Common Sense Camera Care and Practice ...	69
Taking Photographs	41	The Importance of Proper Maintenance ...	70
Unloading Exposed Film	42		
Removing a partially exposed roll of film ...	43		

Before taking photographs Preparing to shoot

This chapter describes how to insert a battery and how to attach and remove the Lens and the Roll Film Holder.

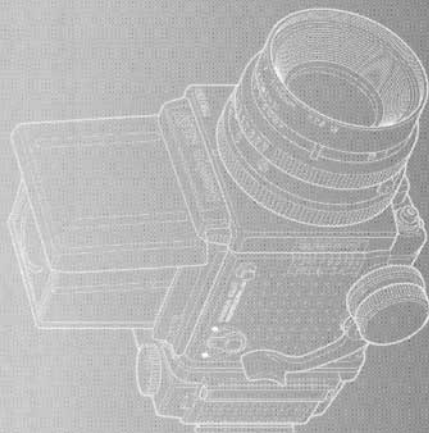

Loading the Battery (The camera will not operate unless battery is loaded.)

1. With your fingernail, slide the Battery Chamber Cover, on the bottom of the camera body, as indicated by the arrows in the illustration. Open the Battery Cover. The camera requires a 6V alkaline, silver oxide or lithium battery. It is a good idea to wipe the battery terminals before insertion to assure proper contact. Observe polarity.

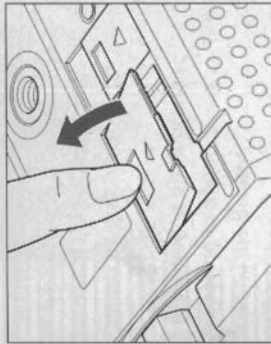

2. ⊕ position is marked in battery cavity. Insert the ⊖ side first at a steep angle and then push entire battery into place, making sure that the lift ribbon ⊕ wraps around battery. Close cover by pushing it down.

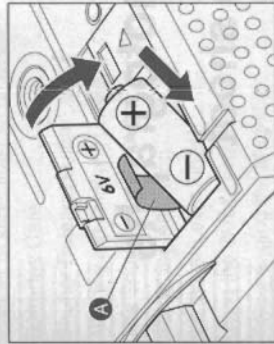

- ★ Be particularly careful not to let the lift ribbon cover the ⊖ terminal.
- ★ This camera cannot be operated without a battery. Be sure to insert a battery before operating the camera.
- ★ The camera requires a 4SR44 silver oxide, 4LR44 alkaline manganese or 2CR1/3 lithium battery.

Shutter Release Battery Check

By looking at the LED in the Viewfinder on the body, you can see the remaining battery capacity. Attach the Roll Film Holder to the body and leave the Dark Slide inserted.

Align the white □ on the Selector Lock Lever **A** on the body with the white ○ on the Shutter Release Selector **B** so that the shutter is locked, to avoid accidental shutter release. Press the Shutter Release Button halfway down and the LED in the Viewfinder will light to show the battery level.

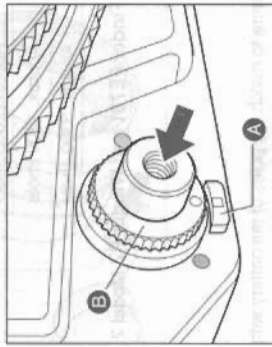

Battery capacity check

The battery capacity can be read by watching the LED in the Viewfinder (lit steadily or blinking, and the alarm sound):

Lit steadily... Battery full

Blinking... Battery is running low. Obtain a new battery to replace this one.

Blinking and sounds an alarm... Battery is extremely low.

Replace with a new battery right away. In this condition, you cannot release the Shutter.

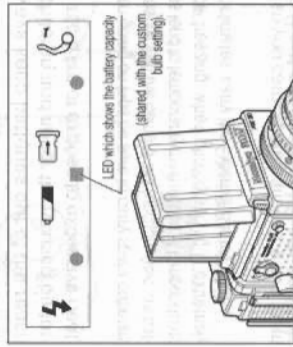

(This mark only appears when the Viewfinder screen is a type A Matte or a type A4 Checker.)

Number of shots that can be mode (under our test conditions)

At normal temperature (20°C)(68°F)

Silver oxide button cell battery (4SR44)	Approx. 2600 shots
Alkali battery (4LR44)	Approx. 1300 shots
Lithium battery (2CR1/3)	Approx. 3300 shots

★ RZ67PROIID body with Z110mm f/2.8W, AE Prism Finder FE701 and Winder RZ Model 2.

Batteries Care

- The sealed, new battery which is supplied with this camera may have been subject to storage conditions which have reduced its service life. Therefore it is desirable to replace it with a fresh battery as soon as possible.
- Carefully wipe the battery contacts before inserting into the chamber. Failure to do so may result in poor electrical contact and consequent malfunctioning of the camera.
- Always remove battery when camera is not used for a while. Always carry spare batteries.
- Battery life differs, depending on type, age, storage condition, ambient temperature, frequency of use etc.
- Be sure to match the poles of the battery with those shown in the diagram in the chamber.
- Always keep batteries out of the reach of children and never throw used batteries into a fire or expose to excessive heat.
- When going on trips be sure to carry spare batteries to ensure that the camera will function. Also, as batteries tend to temporarily malfunction at temperatures below freezing, when photographing in extremely cold climates, carry the External Battery Case.
- When you carry spare batteries, leave them in the original factory packaging. If they are "unpacked", be sure to wrap them carefully in order to prevent them touching each other or any metal objects which can cause them to short circuit and become useless.

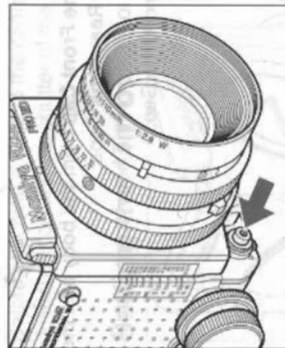

The Shutter Release Button uses a two-step system. At the 1st step of being pressed down, the LED in the Viewfinder lights. When the button is pressed further, the 2nd step, the Shutter will be released. After pressing the Shutter Release button halfway down, press it the rest of the way down to release the Shutter and take a picture. When the Shutter Release Button is pressed halfway down, the camera will measure light level of the scene in the AE Prism Finder FE701.

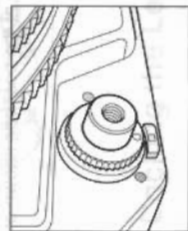

Normal position

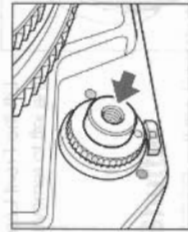

Half-press



Release position

★ When the R-M Lever is in the R position, press the Shutter Release Button halfway down and the R-M Lever will return to the normal (□) position.

Attaching and Removing Lenses

Before attaching the Lens

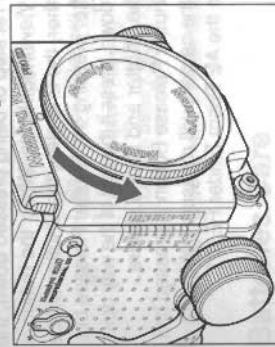

Remove the Front Cap from the body and the Front and Rear Lens Caps.
Turn the Front Cap on the body counter-clockwise to remove the Cap.

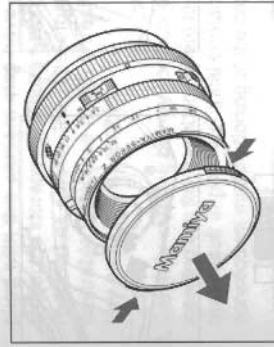

Lift the Front Lens Cap at the positions shown on the left to remove it.

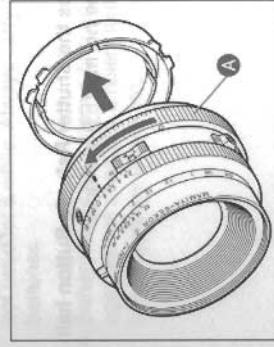

Remove the Rear Lens Cap by turning the Bayonet Ring **A** clockwise until it stops.

Before attaching a lens to the camera body, the mirror in the body must be set in the down position and the shutter of the lens cocked.

Setting the Mirror



Make sure the mirror is set (lowered). If the mirror is in the up position, lower it by pushing the Cocking Lever as far as it will go toward the front of the camera body.

Cocking the Lens Shutter

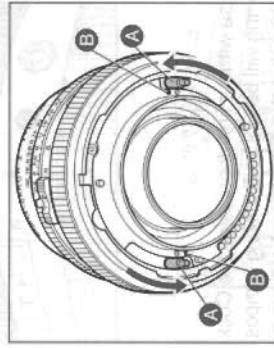

If the lens shutter is not cocked, firmly rotate the Shutter Cocking Pins **A** as far as they will go to the red dot **B**.

★ Moving the Shutter Cocking Pins only as far as the green dot will result in incomplete shutter cocking. Be sure to rotate them as far as the red dot **B**.
★ Whenever a lens is removed from the camera body, it is already cocked.

Attaching the Lens



1. With the front of the lens facing you, rotate the Bayonet Ring counterclockwise as far as it will go (the white dot **A** on the Bayonet Ring will be aligned with the central index **B** on the lens mount).

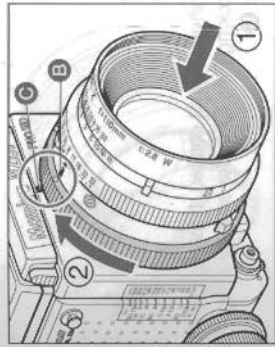

2. Seat the lens on the camera body with the red index line **B** on the lens mount facing the red alignment dot **C** of the camera body. Next, rotate the Bayonet Ring of the lens firmly in a clockwise direction, securing the lens to the camera body.

Removing the Lens

If you try to rotate the Bayonet Ring counterclockwise without first depressing the Cocking Lever of the camera body, the movement of the ring will be blocked, making it impossible to remove the lens. This safety feature assures that the mirror must always be lowered whenever the lens is removed, thereby assisting the Light Baffle in shielding the film from light.

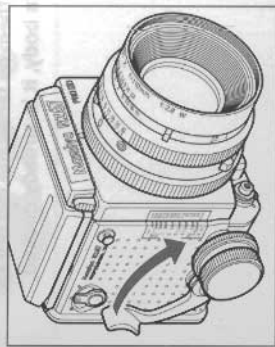

1. Push the Cocking Lever of the camera body completely down, which will set the mirror and cock the lens shutter.



2. Rotate the Bayonet Ring of the lens counterclockwise as far as it will go (the white dot **A** on Bayonet Ring will align with central red index line **A** of lens) and remove the lens.

The Aperture Ring

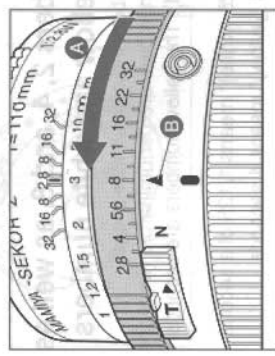

To set the diaphragm to a desired aperture, rotate the Aperture Ring **A** until the appropriate figure is aligned with the central index line **B**. It is perfectly acceptable to use the Aperture Ring at in-between click-stop settings. When the Shutter Release Button is depressed, the diaphragm will automatically stop down to the preselected aperture before the shutter opens for the exposure.

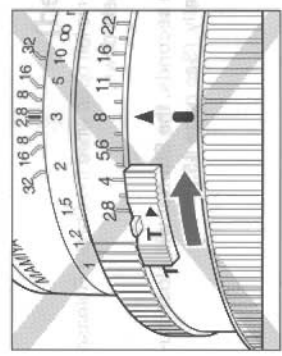

If the Time Exposure Lever stops in between the N (normal) and T (time) indicators, the Shutter cannot be released normally. For normal shots, move the Time Exposure Lever to the left, until the N (green) indicator can be seen. **A**

★ When you are adjusting the Aperture Ring, you might touch the Time Exposure Lever and it is possible that you will move it to a position in between the two marks. Please pay attention when adjusting the Aperture Ring.

Removing/Attaching the Waist-Level Finder

Removing the Waist-Level Finder

To remove the Waist-Level Finder, push the right and left release buttons towards the rear of the Finder and while holding them in, lift the front of the Finder.

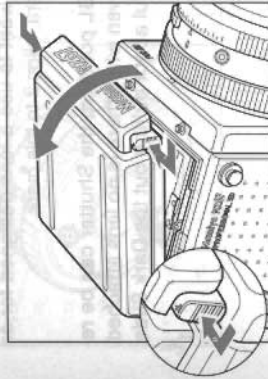

★ These release buttons are equipped with a safety mechanism so that they cannot be removed merely by pushing them from the right or left side.

Attaching the Waist-Level Finder

1. To attach the Waist-Level Finder, slide the Finder Catches **A** into the groove of the camera body **B**.

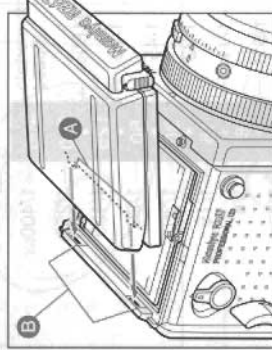

2. While holding in both Finder Release Buttons **C**, seat the front of the finder on the camera body. The finder will lock in place after releasing pressure from on the Release Buttons.

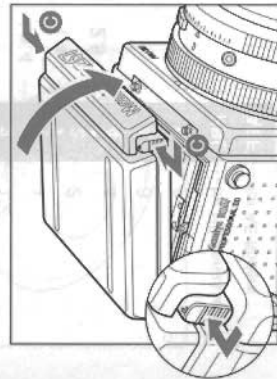

Using the Waist-Level Finder

Raising the Waist-Level Finder

Merely lift the back of the Finder until it opens completely.

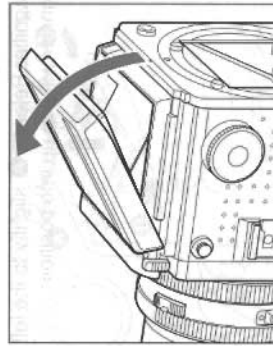

Folding the Waist-Level Finder

After lowering the Magnifier, gently squeeze the right and left panels of the finder together while closing it.

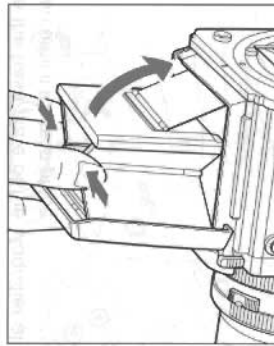

★ When folding down the Waist-Level Finder, be careful not to catch your fingers.

Raising the Magnifier

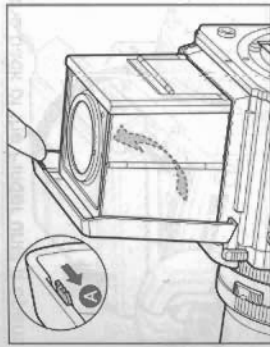

Slide the Magnifier Release **A** slightly to the left and the Magnifier will pop up into position.

Lowering the Magnifier

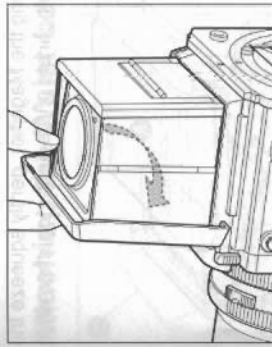

Gently push the base plate of the Magnifier all the way down until it locks in place.

Attaching the Roll Film Holder

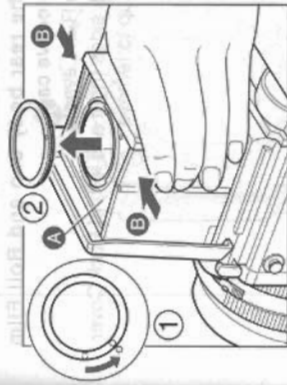

To remove the Magnifier, gently squeeze the magnifier frame **B** with the sides of the finder and rotate the Magnifier counterclockwise.

Attaching the Magnifier

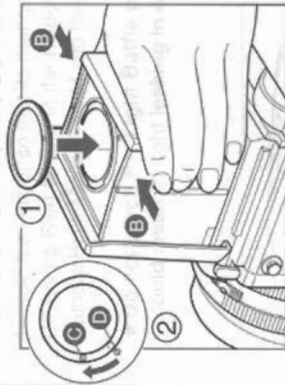

To attach the Magnifier, align the white dot on the Magnifier frame, and rotate the Magnifier clockwise.

★ The Magnifier is interchangeable. In addition to the standard (-1.5 diopter) lens, +1, 0, -1, -2 and -3 diopter lenses are also available. Please note that plus lenses are for far-sighted and minus lenses are for near-sighted individuals.

To attach or remove the Roll Film Holder

Before attaching

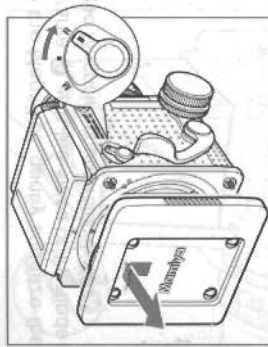

Remove the rear body cap and Roll Film Holder protective cap.

1. Turn The R-M Lever to R.
2. Hold both sides (right and left) of Back Cover and lift it up to remove.

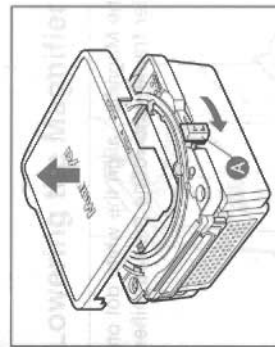

The Protective cap on the Roll Film Holder can be removed by sliding the Lock Lever **A** on the Roll Film Holder to the left (towards "OPEN").

Confirmation

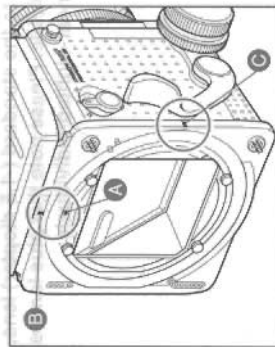

Align the orange circle **A** of the Revolving Ring (found at the rear of the camera) with one of the two white index marks **B** or **C** on the camera body.

★When the orange circle is aligned with Index mark **B** the camera will shoot with a horizontal format. When it is aligned with Index mark **C**, it will shoot using a vertical format. (See page 39.)

★The Roll Film Holder can also be attached in the **C** position.

Attaching the Roll Film Holder

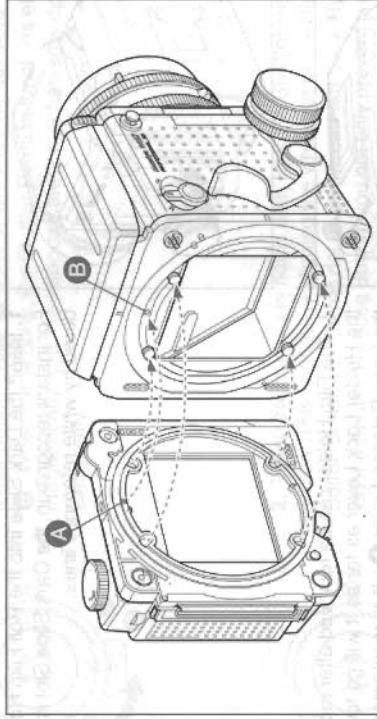

1. Hold the Holder so that its orange circle **A** is at the same position as the one on the Revolving Ring **B** and fit the holder onto the camera back, making sure that the four Camera Back Mount Pins fit into the four openings of the holder.

★Do not touch the Light Baffle or mirror with your fingers. Touching the Baffle could result in light leaking in or other malfunction.

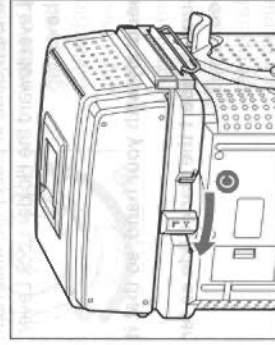

2. Lock the holder to the camera body by moving the Slide Lock **C** as far as it will go as indicated by the arrow.

★Make sure that the holder securely couples with the camera body; otherwise light may leak in and cause film damage.

Because of the revolving back feature, attaching the roll film holder to the camera requires a little practice. We find that a good method is to place the bottom edge of the holder against the bottom edge of the body, (preferably while resting on a flat surface) letting the top of the holder leave a slight gap, permitting you look down and to match the two bottom mounting pins of the revolving back to the corresponding holes of the holder.

Removing the Roll Film Holder

1. Insert the Dark Slide into the Roll Film Holder. For instant recognition, the Dark Slide Slot is bordered by white reference lines.

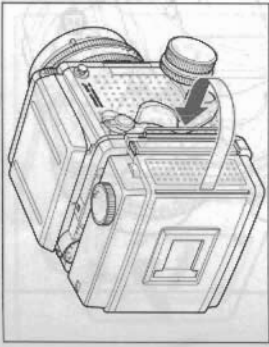

2. The Film Holder can be removed after moving the Holder Lock Lever as far as it will go toward the Lock Release Lever. It is recommended that you remove the holder on a table or similar support, or in your lap, to avoid the possibility of dropping the holder or having it fall off the camera.

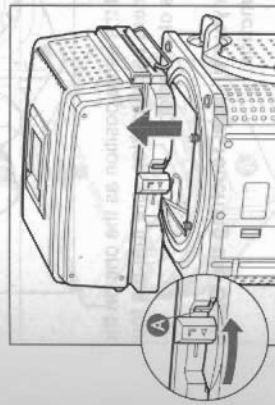

If you attempt to remove the holder without replacing the Dark Slide, the Holder Lock Lever will automatically lock in place, preventing accidental removal of the holder and exposure of the film. However, if you must remove the holder without the Dark Slide in place, the automatic lock can be overridden by pulling the Lock Release Lever toward the Holder Lock Lever, holding the lever there, and then moving the Lock Lever.

- ★ When removing the Roll Film Holder, hold it securely with your hand, so that it can't fall.
- ★ Before removing the Roll Film Holder, make sure to insert the Dark Slide as far as it will go. Otherwise, the film will be exposed.

Using the Release Button Collar

1. For normal operation, align the white square (B) on the Release Button Collar (A) with the white dot on the lever below (E). When this is done, the Shutter Release functions electrically and the various safety mechanisms operate electrically.

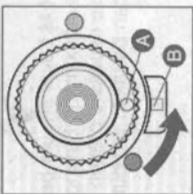

2. When the camera is not in use, lock the Shutter Release Button. This is done by aligning the white dot of the Release Button Collar with the red dot (C) on the camera body. By locking the Shutter Release Button, you not only prevent unintentional exposure of film, but also prevent accidental battery depletion caused by pressure on the Release Button. For this reason, be sure to lock the Release Button when carrying the camera in a bag.

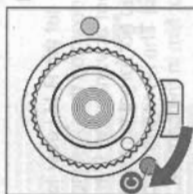

Emergency Shutter Operation

If you were to suddenly find yourself with a dead battery in the midst of a photographic session, switch over to the emergency shutter operation mode. In order to do so, push the Collar Stop lever (D) toward the camera body and while holding it there align the white dot of the Release Button Collar with the orange dot (E) on the camera body. The shutter will now operate (even without a battery) at approximately 1/400 sec., regardless of the setting of the Shutter Speed Dial. Because electricity is not being used in the emergency shutter operation mode, the Monitor Lamps in the viewfinder will not illuminate. Moreover, even if the Dark Slide is not withdrawn, the shutter can still be released, so exercise care.

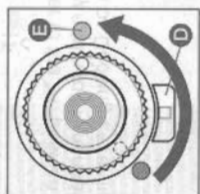

- ★ After installing a new battery, make sure to turn the shutter selector ring to the normal position.

The Normal Position (□)

For normal operation of the camera, the R-M Lever should be kept in the center position, aligned with the index mark. Setting the lever to this position activates the double exposure prevention mechanism so that photo after photo can be taken without fear of accidental double exposures.

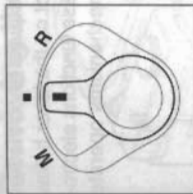

Multiple Exposure Position

When desiring to make multiple exposures, set the R-M Lever to the 'M' position. When this is done, pushing down on the Cocking Lever will cock the lens shutter, but will not advance the film. Upon completion of the multiple exposure, do not forget to return the R-M Lever to its normal (center) position. The lever can also be set to 'M' when testing the shutter without film in the camera.

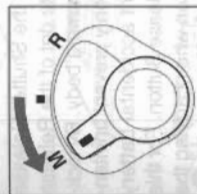

Revolving Back Position

Before revolving the back, set the R-M Lever to the 'R' position. After this is done, the lever will automatically return to the normal position when the Shutter Release Button or Cocking Lever is next used.

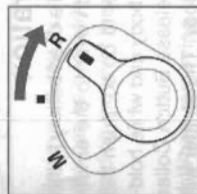

★ The Rotating mechanism is used to take shots in horizontal or vertical formats by turning the Roll Film Holder 90°, without changing the position of the camera body. (See page 39.)

Taking photographs

This chapter describes how to install film and it covers basic picture taking methods.

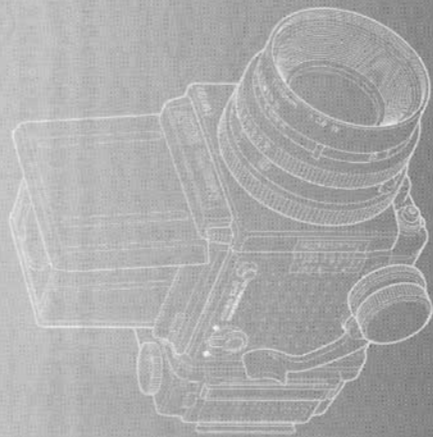

Loading the Film Holder

A roll of film can be installed before the Roll Film Holder is attached to the camera body, or after.

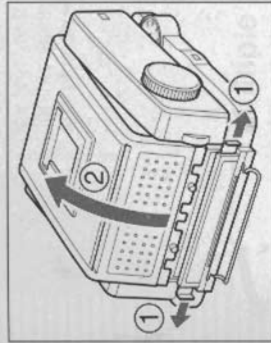

1. Open the Back Cover of the Roll Film Holder.

Pull out the upper and lower Back Cover Latches on the Roll Film Holder and the Back Cover will open.

★ Because of the double safety lock, the Cover will not open by pulling out just one of the two Back Cover Latches.

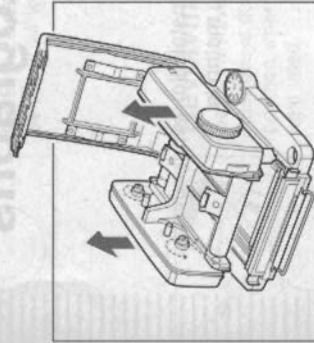

2. Take out the Film Insert

After opening the back cover of the Roll Film Holder, remove the Film Insert. When loading film, it is not necessary to remove the Film Insert from the Roll Film Holder.

★ When loading film, avoid direct sunlight, either by loading in a shady area or by turning your body away from the sun and using the shade of your own body.

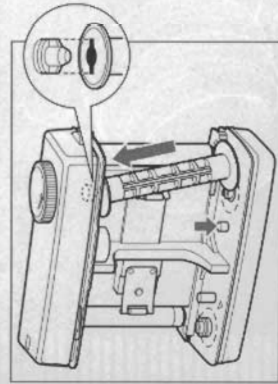

3. Attach the empty Take-up Spool

Hold down the Spool Release Pin on the right side of the Film insert. Then, install an empty Take-up Spool, matching it to the Spool Bearings.

Advancing the Film

4. Loading film

Hold down the Spool Release Pin on the left of the Film Insert. Load a roll of film onto the Take-up Spool, while aligning the film alongside the Speed Receiver Plate.

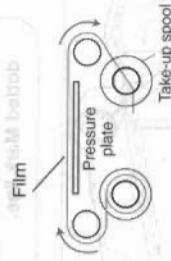
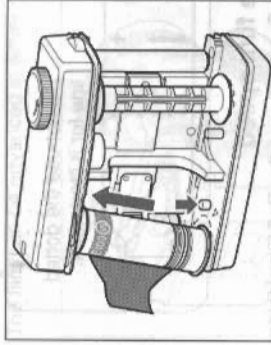

5. Attach the backing paper to the Take-up Spool.

Slowly pull the backing paper out of the fresh film and insert the tip of the paper into the groove on the Take-up Spool, on the right side of the Film Insert.

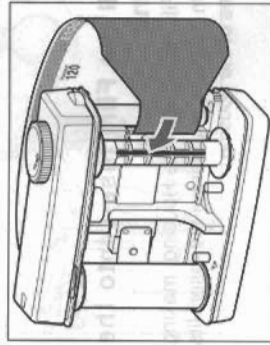

6. Align the start mark

Gently wind the Film Advance Knob on the Film Insert counterclockwise until the start mark on the backing paper is aligned with the white triangle on the left side of the Film Insert.

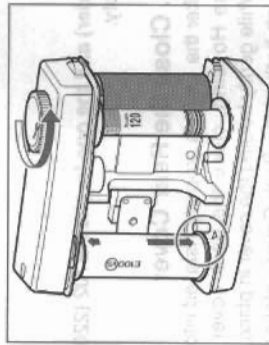

★220 Film Loading Caution:

220 films have two types of Start Mark Lines across the paper leader. Always use the second one, a solid line with the legend "Start Mark for standard cameras", located about 14cm (5 1/2"), behind the first, dotted Mark line.

Do not use the dotted line for a start mark.

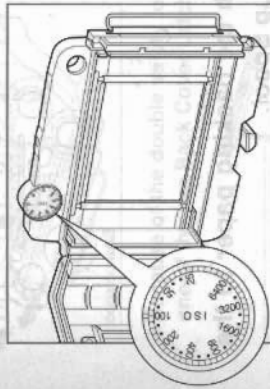
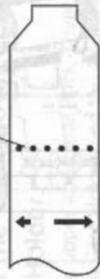

7. Set the film speed

Set the Film Speed Dial on the Roll Film Holder to the correct film speed for the film you are using.

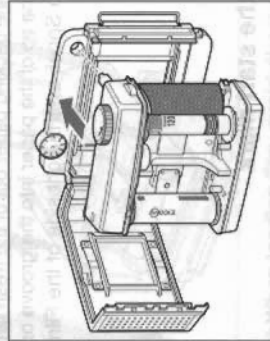

8. Install the Film Insert into the Housing.

Place the Film insert into the Housing, making sure the film advance coupler on the insert fits into the holes of the housing.

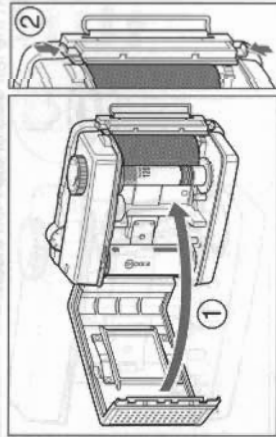

★The housing for the HA703 (120 Roll Film Holder) and the one for the HB702 (220 Roll Film Holder) can be used interchangeably.

9. Close the Rear Cover

After the insert is properly installed into the Housing, close the back cover. While gently holding the cover in place, push both of the Back Cover Latches as far as they will go to lock the Rear Cover.

The film can be advanced in either of two ways.



A. By winding the Film Advance Knob of the Film Insert until it stops.

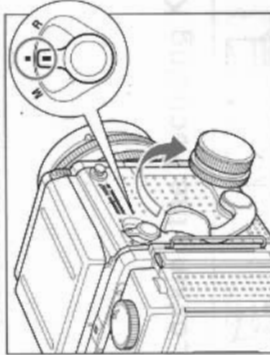

B. By activating the Cocking Lever of the camera body several times, until it stops. (The lens shutter will not be cocked unless the Cocking Lever is moved all the way until it stops.)

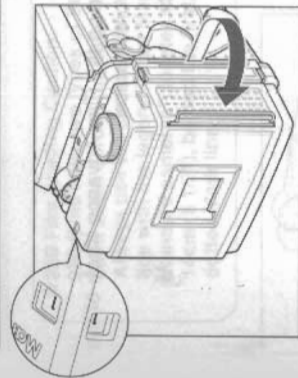

When the film is completely advanced, the numeral '1' will appear in the Exposure Counter, making the first frame ready for exposure.

While advancing the film from S (start) to 1 with the Cocking Lever, the shutter releasing mechanism is automatically locked until the film is fully advanced to frame 1.

Since there are vertical and horizontal exposure counter windows, an upright numeral can be seen with the Roll Film Holder in horizontal or vertical position.

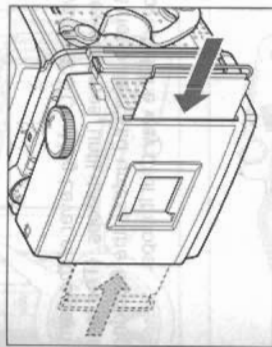

During exposures, the Dark Slide can be stored in the Dark Slide Slot in the back of the holder.

Memo Clip



The Memo Clip on the Back Cover accepts the box top of the film carton and can also be used for other reminders.

Focusing

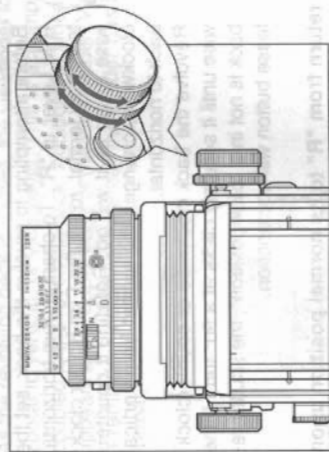

Depressing the Cocking Lever sets the mirror, projecting a bright image on the focusing screen. Focus is rotated either Focusing Knobs until the image appears sharp. Please use the large inner knob for fine focusing.

Locking the Focusing Knob

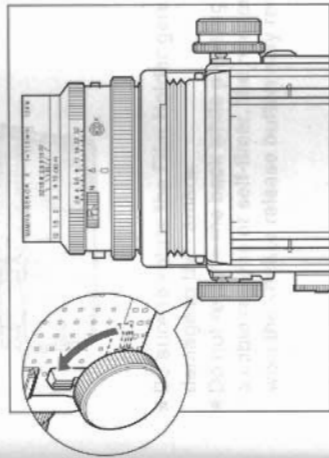

After adjusting the focus, focus shift can be prevented by locking the Focusing Knob with the Focusing Knob Lock Lever, which is located behind the left hand Focusing Knob. Simply raise the lever and push it forward, clamping the Focusing Knob in place.

★Refocusing:

If the focusing knob is moved accidentally while it was not locked the image may be out of focus. Also, be careful that you do not touch the focusing knob at the down stroke of the film transport lever.

The Vertical and Horizontal Formats

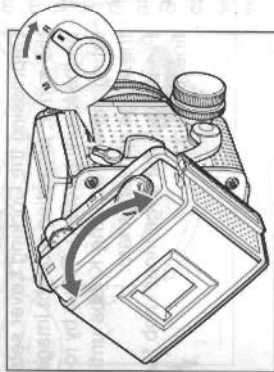

Before attempting to revolve the back, set the R-M Lever to "R". To change from horizontal to vertical format, rotate the Film Holder clockwise as far as it will go. Rotating it counterclockwise, changes the format from vertical back to horizontal.

Revolve the back clockwise or counterclockwise until it securely clicks at a 90° turn. If the back is not in a "click position", the shutter release button will not function.

★ The R-M Lever will automatically return from "R" to its normal position upon depressing the Cocking Lever or Shutter Release Button. However, as long as the R-M Lever remains at the "R" setting, the Film Holder can inadvertently be moved off-center. Therefore we recommend, returning the lever to its normal position (i. e., center index mark) immediately after revolving the back.

Change in Viewfinder Format

As the revolving back is rotated, the viewfinder format automatically changes from horizontal to vertical, or vice versa. This is accomplished by viewfinder masks which are coupled to the revolving back. Additionally, when viewed from the top, a small rectangle appears at the upper edge of the Film Holder. Visible at a glance, this rectangle acts as a reminder, indicating whether the holder has been set for the vertical or horizontal format.

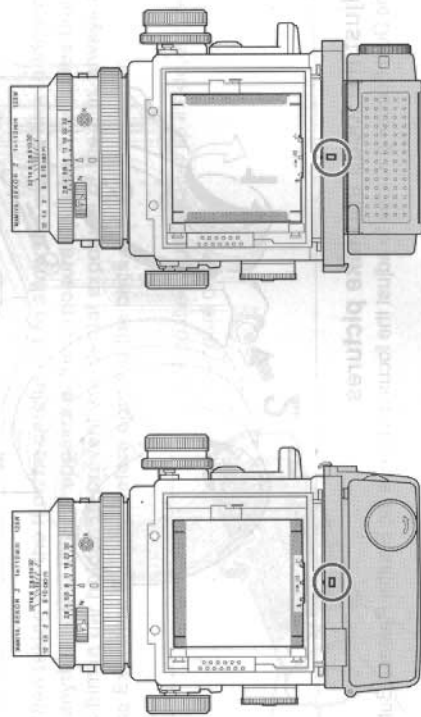

★ Be sure to rotate the Film Holder gently, as undue use of force can result in damage to the camera.

★ Do not revolve the back while pressing the shutter release button. When using a cable release or self-timer, the release end must be correctly adjusted; otherwise the shutter release button may remain depressed.

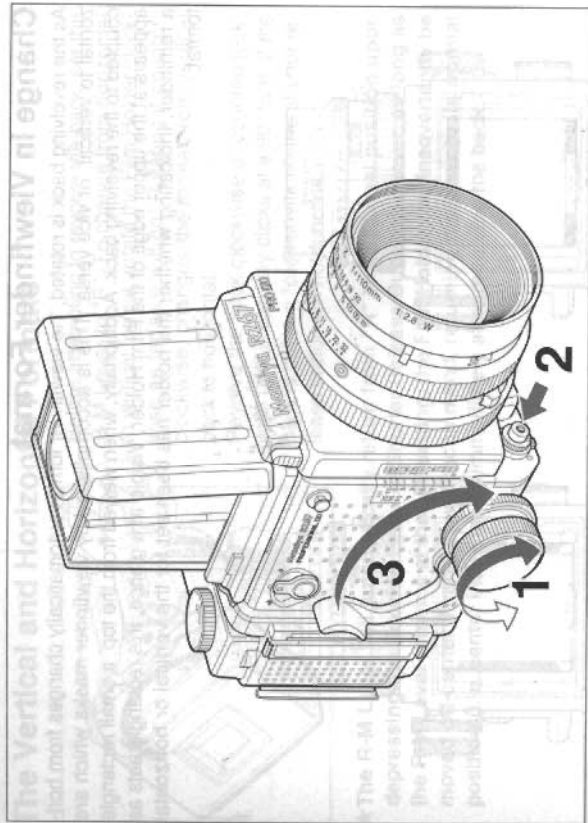

1. Adjust the focus and take pictures

Turn the Dual Focusing Knobs to adjust the focus and press the Shutter Release Button.

2. Press down the Cocking Level.

A single press of the Cocking Lever, resets the Mirror, cocks the Lens Shutter, and feeds the film. The camera is ready for the next shot.

3. After you have taken a full roll of pictures

After you have taken a full roll of pictures, there will be no resistance to winding. Press the Cocking Lever several times to wind up all the film and backing paper. When the film backing paper has been completely wound up, the Cocking Lever will become very easy to press.

★ Before taking photographs, make sure to pull the Dark Slide all the way out of the Roll Film Holder. Be careful because, if the Shutter Release Button is pressed while the Dark Slide is still being pulled out, the Shutter may be released.

★ The A120 or 220 film used with the RZ67 PRO IID is not perforated at the edges, unlike 35 mm film. Therefore, if the Cocking Lever is pressed very rapidly, the spacing between the frames may be uneven or double exposures may occur. Therefore, be sure to operate the Cocking Lever gently, using even strokes, to maintain proper frame spacing.

1. Then open the back cover of the Film Holder and remove the Film Insert.

While holding down the right-hand Spool Release Pin, remove the film, making sure that the backing paper does not unroll or become loose.

To prepare for future use, remove the empty spool from the Film Insert and move it to the right-hand side so that it will act as the new Take-up Spool.

When the back cover of the holder is opened, the Exposure Counter will automatically return to 'S' (Start).

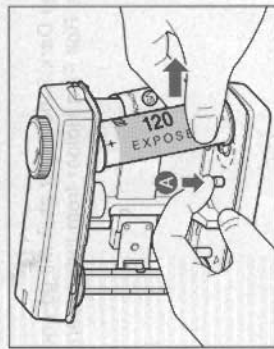

★ When taking out the film, be careful not to allow the wound film to loosen.

★ If anything other than 'S' appears in the Exposure Counter, it indicates that there is film in the holder. To prevent accidental exposure of the film, always check the Exposure Counter before opening the back cover of the holder.

2. Fold the backing paper tip inside, as shown in the figure on the left.

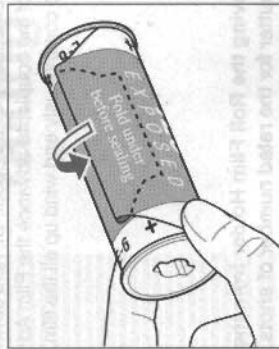

3. Seal the wound film using the seal already attached to the film.

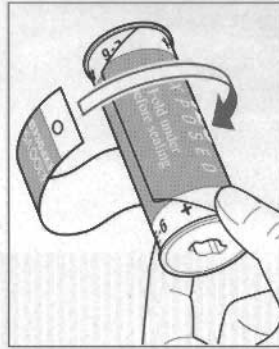

★ The seal on the film can be activated by wetting it slightly.

★ Do not take the exposed film out of the camera in direct sunlight.

★ Put the exposed film in a bag or box right away, to keep it away from the light. Take it to your photo developing shop at the earliest possible opportunity.

Removing a partially exposed roll of film

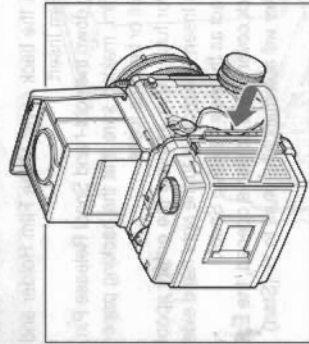

1. Insert the Dark Slide as far as it will go and remove the Roll Film Holder from the camera body.

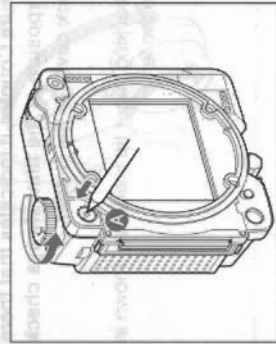

2. Press in the center of the coupler **A** using a pointed object (such as a ballpoint pen) for each full turn of the Film Advance Knob to wind the film completely onto the Take-up Spool. Or, hold down the center of the coupler to advance the Film Advance Knob continuously and wind up all the film.

★ If you want to wind up the film without removing the Roll Film Holder from the body, put on the Lens Cap and release the Shutter for the rated number of shots. Then press down the Cocking Lever several times to finish winding up the film.

3. After you have taken a full roll of pictures, the Roll Film Holder will be ready to be removed. To do this, press down the Cocking Lever several times to finish winding up the film. Then press down the Lens Cap and release the Shutter for the rated number of shots. Then press down the Cocking Lever several times to finish winding up the film.

★ Before taking photographs, make sure the Roll Film Holder is properly inserted while the Dark Slide is in place. To do this, press down the Cocking Lever several times to finish winding up the film. Then press down the Lens Cap and release the Shutter for the rated number of shots. Then press down the Cocking Lever several times to finish winding up the film.

Taking photographs

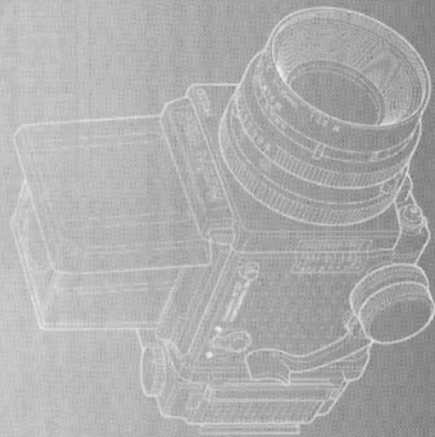

Bulb (B) Exposures

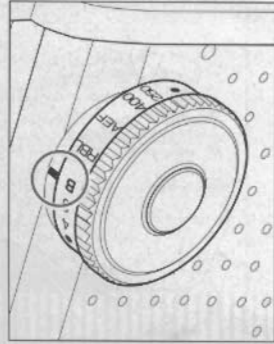

When the Shutter Speed Dial is set to B, the shutter will remain open as long as the Shutter Release Button remains depressed. Since bulb exposure is also controlled electronically, the shutter will automatically close after approximately one minute in order to prevent inadvertent battery depletion.

When using bulb, after the Shutter Release Button has been depressed for approximately 55 seconds, a warning buzzer will sound. If pressure on the Release Button is maintained, the buzzer will continue for about 5 seconds longer, after which the electricity will be automatically cut off and the shutter will close.

If you want exposures longer than one minute, set the camera in the time exposure mode, or release the shutter using a custom setting. (See page 60.)

Time Exposures

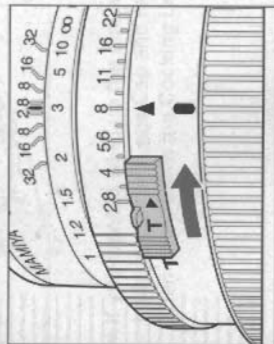

1. To make a time exposure, first slide the T Lever of the lens until the letter "T" under the lever is visible and the normal "N" making is covered. After doing so, the shutter will remain open upon depressing the Shutter Release Button. At this time, the setting of the Shutter Speed Dial on the camera body ceases.

2. To close the shutter, slide the T Lever in the opposite direction, exposing the letter 'N' (normal). During time exposures, do not touch the Cocking Lever until the shutter closes.

★ Since the shutter operates mechanically, not electronically during a time exposure, there is virtually no drain of battery power, and the shutter speed dial can be set in any position other than "RBL".

With the RZ.67 PRO IID, it is possible to lock the mirror in the up position beforehand, and at the desired instant release the shutter without the usual accompanying mirror movement.

Referred to as "mirror lock-up operation," this technique is extremely valuable when even the slightest mirror vibration must be eliminated. When the mirror rises, it usually causes vibrations the very instant before the shutter opens, creating a possible loss of sharpness when working at high magnifications or with long shutter speeds. Consequently, mirror lock-up operation is especially useful when engaging in close-up photography, using telephoto lenses, and making long ("slow") exposures. Yet another application is when trying to catch the peak of action. By raising the mirror beforehand, the shutter can instantly be released, totally eliminating the time lag usually present between the time the mirror completes its upward swing and the time the shutter opens.

1. After screwing a cable release firmly into the Mirror Lock-up Socket of the lens, the socket will elevate slightly and the camera will be ready for mirror lock-up operation.
2. Press the Cocking Lever as far as it will go. Step 2 may either follow or precede step 1.
3. Depress the Shutter Release Button and the mirror will rise, but the shutter will remain closed.
4. Press the plunger of the cable release and the shutter will operate.

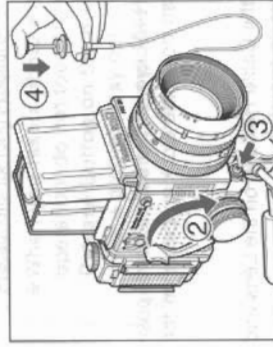
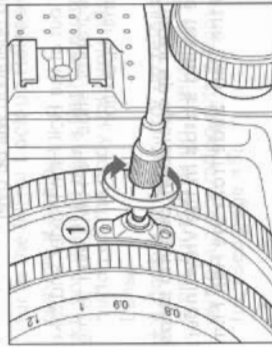

★ When you are through taking photographs using the mirror lock-up operation, remove the Cable Release from the Mirror Lock-up Release Socket on the Lens. The Cable Socket will be retracted and the camera will be released from the mirror up operation.

★ If you press the Shutter Release Button on the body to take a mirror up shot, and if you remove the Cable Release from the Mirror Lock-up Release Socket without taking a photograph, at that moment the camera will release the Shutter at the highest speed (1/400 second), regardless of shutter speed you have set.

★ After you press the Shutter Release Button on the body for a mirror up shot, release the Shutter within 60 seconds using the Cable Release that is attached to the Lens. If you want to wait more than 60 seconds to release the shutter using the Cable Release, the camera will release the shutter at the maximum speed (1/400 second), regardless of shutter speed you have set.

How to stop mirror lock-up operation (return to normal picture taking mode)

After pressing the Shutter Release button on the body



1. Insert the Dark Slide into the Roll Film Holder and press the Cable Release that is connected to the Lens. That will release the Shutter.
2. Slide the R-M Lever on the body to the M position and push down the Cocking Lever on the body.
3. Remove the Cable Release on the Lens and the mirror up operation will be over.

4. The film is not yet exposed. Pull the Dark Slide out of the Roll Film Holder and take photographs. When you are through taking photographs, slide the R-M Lever to the normal position (□) and return the camera to normal operation.

★If you want to change the view angle during a mirror up operation, perform steps 1 and 2 so that you can confirm the picture taking status in the Viewfinder. Since the mirror up mode will continue, pull the Dark Slide from the Roll Film Holder and resume taking photographs.

When an alarm is heard



1. Slide the R-M Lever on the body to the M position and push down the Cocking Lever on the body.
2. Remove the Cable Release on the Lens and the mirror up operation.
3. The film is not yet exposed. Pull the Dark Slide out of the Roll Film Holder and take photographs. When you are through taking photographs, slide the R-M Lever to the normal position (□) and return the camera to normal operation.

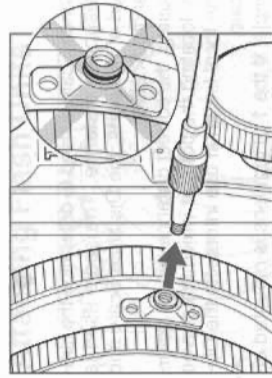

- ★After the Cable Release on the Lens has been removed, if you see a red indicator in the Mirror Lock-up Release Socket, reconnect the Cable Release and then remove it again.
- ★If you want to use a flash in mirror up operation, hold down the Shutter Release button on the body until you release the Shutter using the Cable Release on the Lens.

★A double action mirror up release is available (sold separately) and it is convenient for mirror up operation. Especially, if you want to take photographs in mirror up operation with a flash, this Mirror Lock-up Release accessory is useful. (See page 45)

Precautions for long exposures and mirror lock-up operation

★When you take a photo with a long exposure or use mirror lock-up operation, do not touch the Cocking Lever after pressing the Shutter Release Button on the body, until the exposure is complete. Otherwise, a problem may occur with the distance between frames or there may be some other problem.

Distance Scale

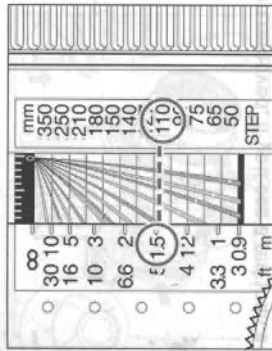

The Distance Scale is used to determine the film-plane-to-subject distance. The scale itself is composed of two parts, the Distance Scale and Focal Length Scale.

After focusing, the correct distance can be determined by locating the point at which the curved line for the focal length in use intersects the Distance Scale.

For example, if the 110 mm lens is mounted on the camera and focused as shown in the illustration, the subject is 1.5 m (5 ft) from the film plane.

Depth of Field

Depth of field is defined as the zone of sharpness before and behind the plane of focus. It depends on camera / subject distance, focal length of lens, aperture setting and distance the lens is focused at.

Depth-of-Field Preview

1. Set the Aperture Ring to the desired f-stop and focus the lens.
2. Depress the Depth-of-Field Preview Lever **A** of the lens and you will be able to check the depth-of-field directly on the focusing screen.

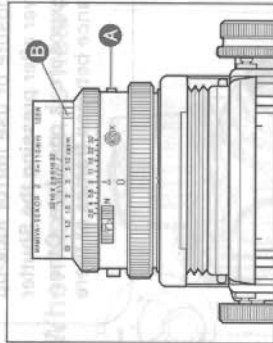

Using the Depth-of-Field Scale

1. Check the camera-to-subject distance on the Distance Scale.
2. Rotate the Lens Distance Scale Knob **B** until the previously noted camera-to-subject distance is aligned with the center index **C** of the Depth-of-Field Scale.
3. Locate the selected aperture on both sides of the Depth-of-Field Scale.
4. The figures of the Lens Distance Scale, appearing above the selected aperture, indicate the nearest and furthest limits of sharpness for that aperture.

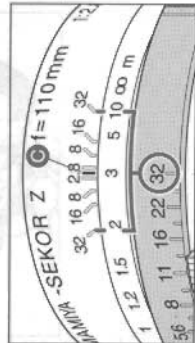

For example, when the 110mm lens is focused at 3 m and stopped down to f/32, everything from approximately 2m to 10m will be in focus.

When desiring to know the depth-of-field in feet, rotate the Lens Distance Scale 180°, as one side is in feet and the other in meters.

Attaching Flash Units

Compact, clip-on units can be attached directly to the Hot-Shoe of the camera. When using large, grip-type units, attach the sync cord of the flash to the Flash Sync Terminal (X-sync) of the lens.

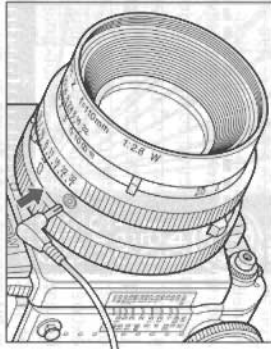

Determining the Aperture

When using automatic flash units, refer to the instructions of the particular flash units for the correct apertures to use.

When using a manual electronic flash unit or flash bulbs with X, the guide number (G.N.) divided by the subject distance gives the correct aperture to use.

$$\frac{\text{G.N. (48)}}{\text{Subject Distance (6)}} = \text{correct aperture setting (8)}$$

NOTE:

Flash time, recharging time and synchro polarity differ depending on the type of flash unit. Check performance by taking test photographs.

Using a Tripod

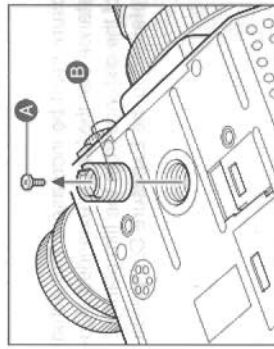

The Mamiya RZ67 PRO IID Tripod Socket accepts a standard 1/4" tripod mounting screw. For use with tripods having 3/8" mounting screws, first unscrew the small black phillips head retaining screw in the center of the tripod socket. Then remove the 1/4" bushing with a thin coin. To reinstall the 1/4" bushing, reverse the process.

Exposure Compensation for Close-up Photography

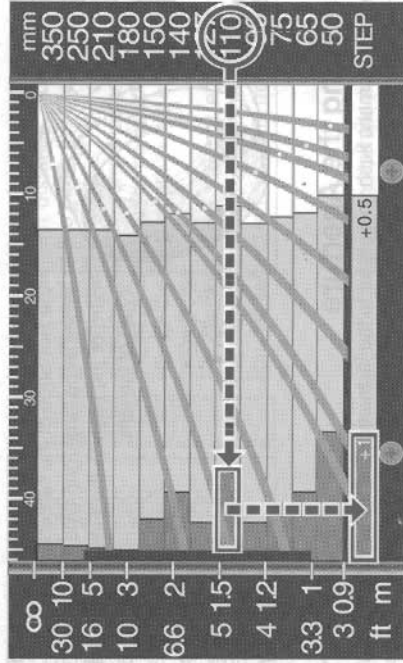

Area Covered with Bellows Fully Extended.

Lens	Subject distance (from lens front rim)	Magnification	Area covered
Fish-eye M 65mm f/4 L-A	85mm	0.7	80 × 100mm
Shift	Z 75mm f/4.5 W	0.6	93 × 115mm
	Z 90mm f/3.5 W	0.51	110 × 136mm
	Z 110mm f/2.8 W	0.42	135 × 167mm
Macro	Z 127mm f/3.5 W	0.36	155 × 192mm
	M 140mm f/4.5 W/L-A	0.32	173 × 214mm
	M 150mm f/3.5 W	0.31	183 × 227mm
Apo	Z 180mm f/4.5 W-N	0.26	217 × 270mm
	Z 250mm f/4.5 W	0.19	297 × 369mm
	Z 100~200mm f/5.2 W	~0.45 ~0.25	~126 × 156mm ~237 × 294mm

When working very close to the subject, the exposure must be increased. The actual exposure factor will vary in accordance with the distance that the lens is extended. (Optical law: Light intensity decreases by the square of the distance from the film plane). Exposure compensation is easily determined by referring to the Exposure Compensation Scale.

After focusing the lens, read the exposure compensation factor on the scale. The scale is divided into three zones of light, medium, and dark shades. As indicated by the table at the base of the scale, the light zone represents an exposure factor of zero (no compensation is necessary), the medium shaded zone indicates +0.5 (a 1/2 stop increase in exposure is required), while the dark zone denotes a factor of +1 (a full stop increase in exposure is necessary).

To find the exposure factor, first locate the figure on the Focal Length Scale for the lens in use. Next, move along the scale, in the same column, until you reach the Distance Graduation. The shading of the zone (light, medium, dark) which touches the Distance Graduation indicates the correct exposure factor. For example, when the 110mm lens is focused as shown in the illustration, the correct exposure factor is +1.

The scale curve for each lens has a white \circ mark which coincides with the right-hand lens indication. So, use the mark to find the corresponding scale curve for each lens.

With a factor of +1, open the aperture by a full-stop. For example, assume that a handheld exposure meter indicates a normal exposure reading of f/16 at 1/60 sec., for an exposure compensation of +1, set the lens to either f/16 at 1/30 sec. or f/11 at 1/60 sec. When using a Mamiya through-the-lens (TTL) Exposure Meter Finder, such as the RZ AE Prism Finder, it corrects automatically for close-up photography.

★For optimum sharpness at the corners when using the 50 mm and 65mm wide-angle lenses at distances closer than 1 meter, use as small an aperture as possible.

★The bellows extension in millimeters appears on the top of the Focal Length Scale. These figures are used to determine the required exposure compensation factor when using extension tubes.

★For areas covered with the bellows fully extended, see the instructions for all interchangeable lenses.

Multiple Exposures

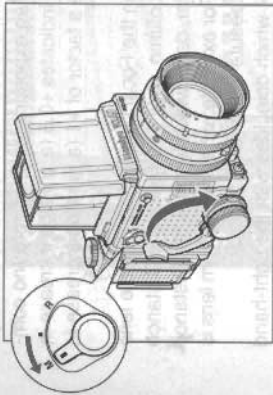

1. Set the R-M Lever to 'M' (multiple exposure). The lever can be moved to 'M' either before or after releasing the shutter.

2. Press the Cocking Lever as far as it will go in order to cock the shutter and set the mirror. The film will not advance at this time. The shutter can now be released, creating a double exposure. This procedure can be repeated as often as desired to create as many exposures as necessary.

When photographing the same subject two or more times through, exposure compensation is necessary. The same is true with different subjects that are all evenly illuminated. With subjects of different brightness, the darker one is normally photographed first. However, it is not within the scope of this operating manual to teach multiple exposure technique, as many excellent books dealing with this subject are already available.

★ CAUTION:

Unlike the "R" lever, the "M" lever does not return automatically to its normal position. Therefore you must do it manually. If you forget, the film is not transported and not only are subsequent exposures wasted, but the planned multiple exposure also.

Infrared Photography

RZ lenses need no focusing mount because of the bellows feature. Normally, lenses with focusing mounts have a secondary index for infrared film. Therefore, if you want to do critical infrared photography, you should focus as usual and before exposures move the focus slightly towards the camera body, as per table below. There is a millimeter scale on top of the focus scale.

RZ67 PRO IID Infrared Correction Table

Shows required adjustment at infinity

Lens	Extension of the bellows (mm)
Fish-eye Z 37mm f/4.5W	0.4
Z 50mm f/4.5W	0.4
M 65mm f/4L-A	0.24
※ M 75mm f/3.5L	0.27
Shift Z 75mm f/4.5W	0.6
Z 90mm f/3.5W	0.4
Z 110mm f/2.8W	0.3
Z 127mm f/3.5	0.4
Macro M140mm f/4.5M/L-A	0.23
Z 150mm f/3.5W	0.4
Z 180mm f/4.5W-N	0.7
Z 210mm f/4.5 APO/L	0.1
Z 250mm f/4.5W	0.6
Z 250mm f/4.5 APO/L	0.1
Z 350mm f/5.6 APO/L	0.1
※ Z 360mm f/6W	1.0
Z 500mm f/6 APO/L	0
Z 500mm f/8W	1.0
Zoom Z 100-200mm f/5.2W	W:1.2 T:0.4

※ Discontinued production

Attaching a Lens with Shutter Released or Mirror Raised

When a lens is removed from the camera body, the mirror is set (lowered) and the lens shutter cocked. Conversely, when attaching a lens, the same conditions should prevail (mirror set and shutter cocked). However, should a lens be attached with either the mirror raised or shutter released, or both, the camera can be reset by following the procedures below.

Mirror condition	Shutter blade condition	Operation
<p>1</p> <p>Lowered</p> <p>Closed</p>		<ol style="list-style-type: none"> Remove the Roll Film Holder. Set the Shutter Speed Dial to other than "RBL." Press the Shutter Release Button. Depress the Cocking Lever. Set the Shutter Speed Dial within the range of "B" to "1/400," that is, not "RBL" or "AEL."
<p>2</p> <p>Raised</p> <p>Open or Closed</p>		<ol style="list-style-type: none"> Remove the Roll Film Holder. Depress the Cocking Lever.

Lens shutter release test

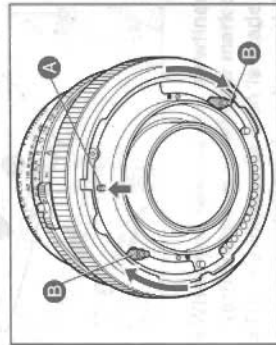

To release the shutter on a lens which has been removed from the camera body, rotate the shutter cocking pins **B** clockwise as far as they will go, while depressing the shutter lock pin **A**.

★ CAUTION:

When attaching/removing the lens, be sure not to rest the camera on its back unless either a roll film holder or the back protective cover is attached. This is necessary to prevent damage to its various spring loaded function pins.

Attaching the Strap

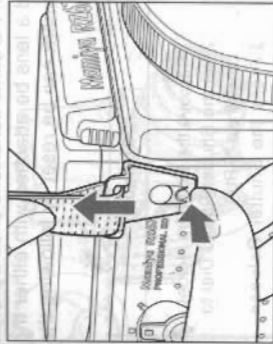

Hold the metal clamp of the strap so that the key-hole shaped opening faces the Carrying Strap Lug on the camera body. Gently fit the upper part of the key-hole opening over the lug. Next, gently push the bottom of the metal clamp upwards and it will lock in place with a click.



If the clamp is attached to the Hot-Shoe side of the camera upside-down, it will be difficult to remove, so be careful to attach the clamp right-side-up.

Removing the Strap

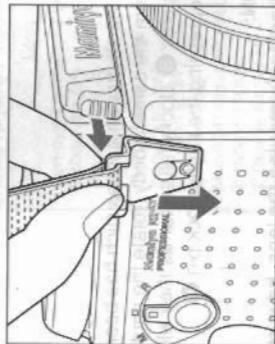

Reach behind the strap and while gently squeezing the top of the protruding front plate (leaf spring), slide the clamp downward and off the lug.



Removing the Focusing Screen

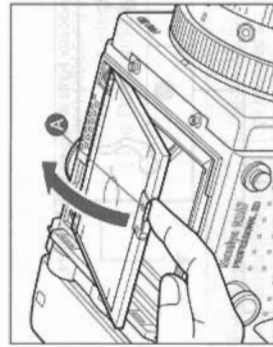

After removing the Waist-Level Finder, lift the Viewfinder Screen Release knob **A** on the camera body with your fingers and then lift and remove the screen.

How to attach the Viewfinder Screen

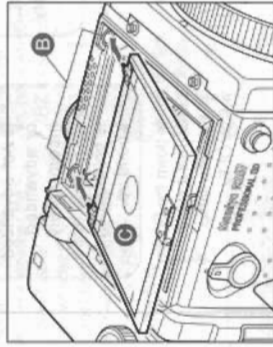

1. While holding the outside of the Viewfinder Screen, put protrusion **C** on the Viewfinder Screen into the Viewfinder Screen securing bracket (left) **B**.

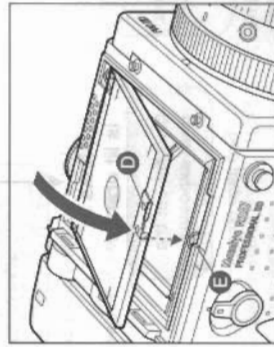

2. Press the Viewfinder Screen down gently onto the body and fit protrusion **D** on the Viewfinder Screen onto the viewfinder Screen securing bracket (right) **E**.

- ★ When you remove the viewfinder Screen, do not touch the metal horizontal/vertical format viewfinder mark or mirror.
- ★ The viewfinder Screen is made of acrylic resin. Its surface is soft and it can easily be damaged, so be careful when handling it. Don't put fingerprints or dirt on it.

Attaching the Strap

※When using the Prism Viewfinder, the positions of the indicator lights are reversed left to right.

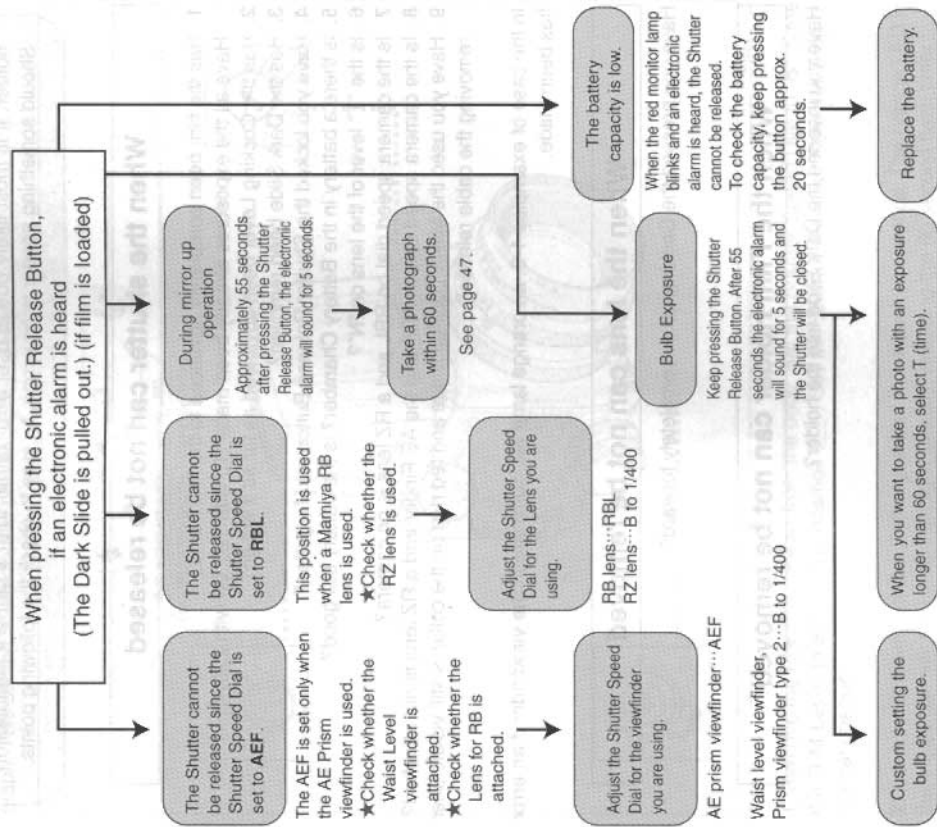
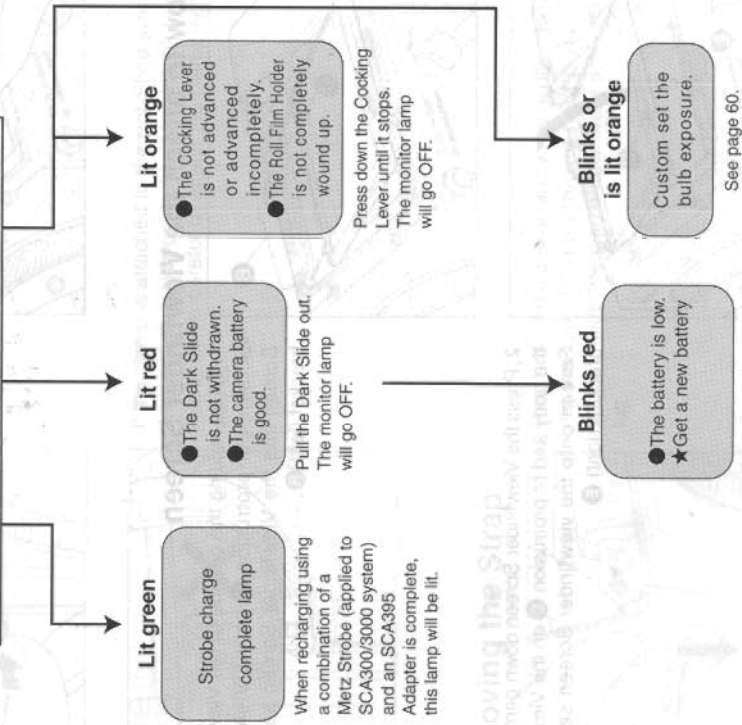
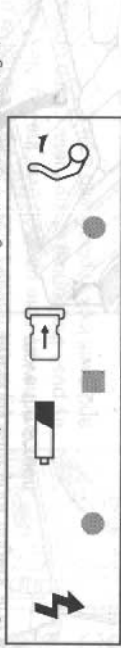

●When a Lens is not attached to the body: When the Shutter Speed Dial is setting is other than RBL, and if the Shutter Release Button is pressed, the alarm will be heard.
●If the camera sounds an electronic alarm in conditions other than those above, contact our service center.

Uniquely designed to prevent errors, the RZ67 PRO IID incorporates numerous safety features, so if you can not release the shutter, or remove a lens or holder, it is most likely due to user error rather than a camera malfunction. Should something appear to go wrong, be sure to check the following points.

When the shutter can not be released

1. Has the film been completely advanced to the first frame?
Have all the exposures already been made (10 with 120, 20 with 220)?
2. Has the Cocking Lever been advanced as far as it will go?
3. Has the Dark Slide been removed?
4. Have you locked the Shutter Release Button and forgotten?
5. Is there a battery in the Battery Chamber? Is the battery still good?
6. Is the "T" lever of the lens on "N"?
7. Is the camera speed dial on RBL and a RZ lens is on camera?
8. Is the camera speed dial on AEF and the AE Finder and a RZ lens is not attached?
9. Have you used the Mirror Lock-up mode and red ring on the collar is still visible after removing the cable release?

In the case of examples 1-3, an orange lamp will illuminate in the viewfinder if an error has been made.

When the lens can not be removed

Have you pressed the Cocking Lever completely forward?

When the Film Holder can not be removed

Have you inserted the Dark Slide into the holder?

To take photographs with an exposure of more than one minute, we recommend using the time exposure mode, which consumes very little from the battery. However, this shot must be made with the Time Exposure Lever and small blurs may occur in the photograph. This setting is effective in preventing these blurs.

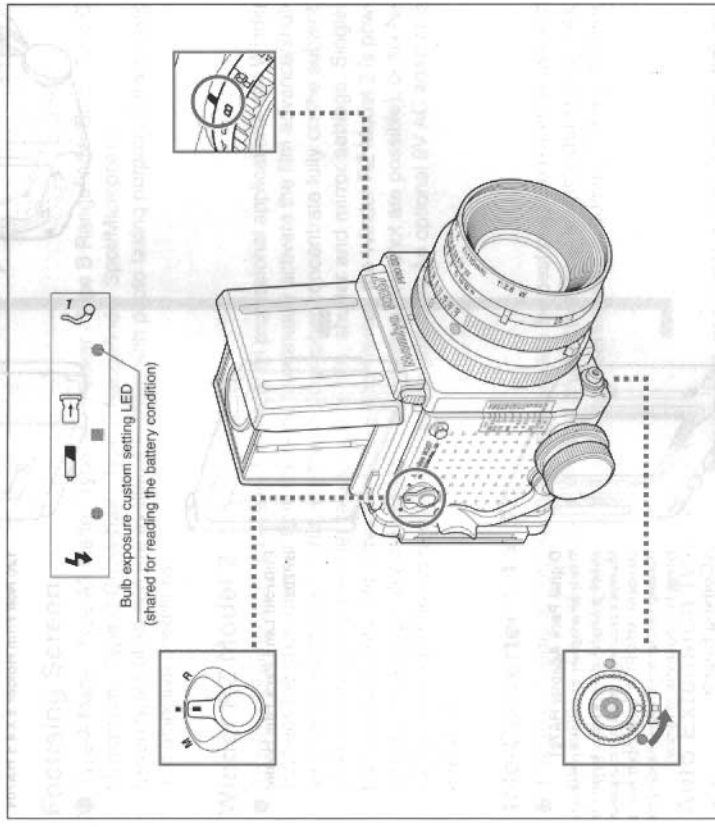

1. Remove the Roll Film Holder from the body. Set the Shutter Speed Dial to "B". Slide the R-M Lever to the normal position (□). Set the Shutter Release Selector Ring to normal position.

2. Keep the Shutter Release Button pressed for at least 10 seconds. The orange LED in the Viewfinder will blink and then light steadily, releasing the 60 second flash timer.

- ★If you want to cancel the bulb exposure custom setting, perform the steps above or remove the battery from the camera.
- ★When the bulb exposure mode is selected, the camera consumes energy from the battery during the exposure.

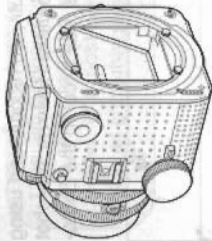

120 Roll Film Holder HA703



220 Roll Film Holder HB702



120 Roll Film Holder 6 X 4.5 HA704



Polaroid Land Pack Film Holder HP702

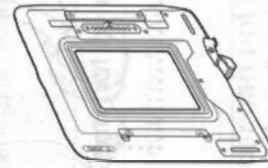

Digital Pack Adapter HA701
This is an adapter that makes it possible to attach a Digital Pack which conforms to Mamiya's proprietary digital communication standard (MISCE). It is equipped with a Rotating Mechanism to allow changing the format from horizontal to vertical.

<Coming Soon>

AE Prism Finder FE701

- This aperture-priority AE finder offers both spot and averaged metering choices, as its own special auto-selection function that switches between spot and averaged automatically to suit the shooting conditions.

Focusing Screen

- Type A Matte · Type A3 Checker · Type B Rangefinder Spot · Type C Microprism · Type D Cross-hair · Type E Rangefinder Spot/Microprism
Seven types of screen are available to meet with photo taking purpose, lens to use, and objective conditions.

Winder RZ Model 2

- An extremely important accessory for almost all professional applications, the Winder RZ frees the photographer from the need to manually activate the film advance/shutter cocking mechanism. This lets the photographer concentrate fully on the subject, while the motorized winder takes care of film, shutter and mirror settings. Single-frame or sequential film advance (1.5 sec/per frame), the Winder RZ Model 2 is powered by six AA type alkaline cells (500-600 consecutive shots are possible), or six Ni-Cd batteries (300-360 consecutive shots are possible). An optional 9V AC adapter is available.

Tele-Converter 1.4 x RZ

- This teleconverter is optically designed to provide the best possible results in use with the superior Z series lenses; it provides an effective focal length extension of 1.4x, and can be recommended for the following Z series lenses: 90mm, 110mm, 140mm, 150mm, 180mm.

Auto Extension Tube RZ

- This series of extension tube, for close-up and macro photography, provides fully automatic shutter operation. This two automatic tube can be used individually or in combination. No 1=45mm extension; No 2=82mm; No 1 + No 2=127mm. Since the camera body bellows features an extension of 46mm, using the tubes provides a total maximum extension of 173mm.

L-Grip Holder RZ

- A contoured left-hand grip that provides excellent balance for both hand-held shooting and for carrying. The grip is equipped with a locking shutter release (electronically linked to the camera's own release) and a cold-shoe for accessories.

Mirror Lock-up Cable Release

- The perfect tool to prevent even the slightest camera shake during slow-shutter-speed exposures; one cable connects to the camera body's shutter release, the other to the Mirror Lock-up switch. When the release is pressed, the Mirror Lock-up operation activates first, followed by operation of the shutter. Very useful for both close-up and telephoto applications.

Magnifier (for Prism Finder)

- Attached to the prism finder, it assures enhanced precision focusing by magnifying the central portion of the screen. After focusing, it can be raised to confirm overall composition. Built-in -6 to $+4$ diopter correction.

Bellows Lens Hood G-2

- Attaches to the front accessory thread of Z series (90mm-350mm) lenses; provides optimum shading of the lens to prevent all stray light. Rack & pinion adjustment allows selection of optimal setting by actual preview; width is easily adjusted; incorporates gelatine filter holder. Maximum and minimum extension of bellows: 110mm and 30mm.

Bellows Lens Hood G-3

- Utilizing side struts, instead of base rails, this Bellows Lens Hood G-3 provides highly efficient protection against extraneous light and it has inserting slot for 3-inch (7.5cm) square filter and 12cm square size vignetter. Vignetter can adjust up and down within 14mm. Gelatin filter mount is provided. Maximum and minimum extent of bellows: 175mm and 50mm.

Front Hood for G-3

- Using the Front Hood for G-3 along with Bellows Lens Hood G-3 will bring higher vignetting efficiency. With the Front Lens Hood used along with Bellows Lens Hood G-3, it can be possible to use 50mm f/4.5w Lens or longer focal length lenses, except for 100-200mm zoom lens and 500mm APO lens. Front Hood for G-3 has an inserting slot for 12cm square size vignetter. Maximum and minimum extent of bellows: 105mm and 25mm.

Mamiya Quick-Shoe AQ701

- The shoe that makes tripod-mounted camera changes quick and easy. Slip on a camera and it instantly locks in place on the shoe automatically. A double-action release mechanism allows quick operation while protection against automatic release.

Electromagnetic Cable Release

- Connects to the electronic shutter release socket of the camera.

Remote Control RS401

- Consists of Transmitter and camera-mounted Receiver. Choice of three infrared channels for interference free operation. 30M operating range. Transmitter uses two AA Alkaline, Receiver one 9 Volt, batteries.

Gelatin Filter Holder Model 2

- A Special holder for 3-inch (7.5cm) gelatine filters; attaches to 50, 65, 90, 110, 140, 150, 180, 250, and 350mm lenses. This holder is indispensable for accurate correction of color (under differing types of light, for example). The holder allows insertion of multiple filters.



CAUTION

The filter holder is not to be used in the dark.

CAUTION:

- The winder RZ-1 cannot be used on the RZ PRO IID body.
- When using the Mirror Lock-up operation in the B (bulb) mode, use an optional double cable release.
- The previous models of AE Prism Finders or AE Magnifying Finders cannot be used with the RZ PRO IID unless their circuits are modified. Contact your country's Mamiya Distributor for further information.
- The AE Prism Finder FE701 can be directly mounted on the RZ PRO IID.
- Electronic Flash Precautions
Electronic Flash units that have a high sync trigger voltage may seriously damage the electronic circuitry of your RZ PRO IID. Flash units with a maximum of 12 volts sync output trigger voltage are safe for use. Please contact your flash manufacturer, or have your local flash repair station test the sync line trigger voltage before using with your RZ PRO IID. Older studio flash power packs are particularly suspect of using high voltage sync trigger voltages, sometimes feeding as much as 400 volts into your RZ PRO IID sync terminal! To prevent this problem, you may consider using a "filter" or regulating circuit between your power pack and sync cord. Contact your local flash dealer or manufacturer for more information about these devices.

Lenses

1. Focusing

RB67 lenses are mounted directly onto the RZ PRO IID; however, the bellows must be extended 7 mm in order to focus the lens at infinity (∞). Therefore, even when photographing distant subjects, be sure to use the Focusing Screen.

CAUTION:

Because of the differences in flange back between the two series of lenses, the Distance Scale of the RZ PRO IID body does not apply when using RB67 lenses.

2. Shutter Speed Selection

When a RB67 lens is mounted on the RZ PRO IID body, use the Shutter Speed Ring of the lens for shutter speed selection.

Be sure to set to the "RBL" position. Once this done all the other speed dial settings are immobilized.

The shutter is cocked and released in the same manner as RZ series lenses.

When using a Mamiya Sekor C lens for the RB series on the RZ PRO IID body, be sure to insert an optional interchange mounting ring into the lens rear mount to assure correct coupling with the camera body.

★Older RB Lenses should be checked before use, to determine if their shutter torque is compatible with the RZ PRO IID. Before trying, please send such lenses to the service department of your country's Mamiya distributor.

★If the Shutter Speed Dial is set to the RBL position, the Shutter can be released even if the Lens is not attached. When you pull out the Dark Slide, be careful not to press the Shutter Release Button.

Finders

When using the RB series PD Prism FINDER or PD Magnifying FINDER be sure the Electrical Contact Cover is in place, for it is used to depress the switch at the base of the finder.

CAUTION:

The RZ PD Prism FINDER will not function on the RZ IID. It cannot be retrofitted.

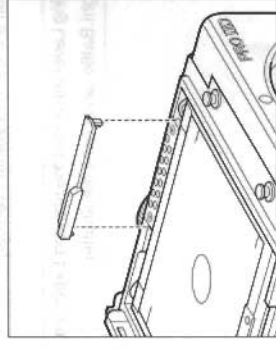

Camera Type	: 6x7cm roll film SLR with lens shutter
Film Holder	: 120 Roll Film Holder HA703---the standard holder 220 Roll Film Holder HB702 6x4.5 120 Roll Film Holder IRZ Polaroid Pack Film Holder HP702
Film type	: 120 film (120 Roll Film Holder HA703) (10 exposure) 120 film (6x4.5 120 Roll Film Holder RZ) (15 exposures) 220 film (220 Roll Film Holder HB702) (20 exposure) Instant film (Polaroid Pack Film Holder HP702)
Negative size	: 6x7 cm format : 56x69.5 mm 6x4.5 cm format : 56x41.5 mm Polaroid Pack : 70x70 mm
Revolving Back	: The back revolves 90 to change from the horizontal to vertical format or vice versa. Viewfinder format automatically changes as back revolves.
Lens Mount	: Special bayonet mount (with built-in safety lock)
Lens type	: 110 mm f/2.8---the Standard Lenses / interchangeable RZ lenses / interchangeable lenses for the RB can also be used.
Shutter	: Seiko #1 electronic shutter
Shutter release	: Body shutter release plus electronic shutter release contacts.
Shutter speed	: 1/400-8 sec. (with intermediate speeds), B, T (mechanical) / RBL (when the RB lens is used) and AEF (when the AE Prism Finders used) positions / Mechanical shutter of 1/400 sec usable.
Sync operation	: with flash sync terminal (X-sync) on lens or hot shoe.
Multiple exposure	: possible by means of R-M lever.
Focusing Screen	: Type A Matte is the standard / Focusing screens for the RZ are interchangeable.
Viewfinder	: Waist-Level Finder FW702 is the standard interchangeable with the AE Prism Finder FE701 / Finders for the RZ and RB can also be used.
Percentage of the field of view visible	: 95% This information is based on a linear (horizontal / vertical) measurement.
Film Transport	: A single 114° stroke of the Cocking Lever advances the film and Exposure Counter, sets the Mirror and Light Baffle, and cocks the shutter.

Focusing Method	: The rack and pinion focusing extends the built-in bellows up to a maximum of 46 mm / Equipped with a Focusing Knob and Lock Lever / With subject distance and exposure factor indications.
Winder	: RZ Winder II (RZ Winder I cannot be used)
Cable release contact	: The shutter can be released by means of a cable release connected to a contact on the camera body / Remote control is possible by means of a receiver connected to the same contact.
Battery Type	: One alkaline battery (4LR44) or one silver oxide battery (4SR11), and one lithium battery (2CR13)
Safety features (in normal shutter release operation)	: Warning on incomplete cocking lever setting / Warning on failure to pull out the dark slide / Battery check.
Viewfinder display (by LEDs and pictorial symbols)	: Electronic alarm sound when : The shutter speed dial is at the "RBL" position when an RZ lens is used / The shutter dial is at the "AEF" position when the AE Prism Finder is removed / The shutter speed dial is any other position than "RBL", when no lens is mounted or an RB lens is mounted on the camera / The battery power has dropped.
Release locked when :	The cocking lever has been set incompletely / The dark slide has not been pulled out / The shutter speed dial is at the "RBL" position when an RZ lens is used / The shutter speed dial is at the "AEF" position when the AE Prism Finder is removed / The shutter speed dial is at any other position than "RBL" when there is no lens on the body or an RB lens is mounted on the camera.
Dimensions	: 108 mm (width) X 133.4 mm (height) X 212.5 mm (length).
Weight	: 2,490g when the body (1,350g) (with Waist-Level Finder), 120 Roll Film Holder (530g) and 110 mm f / 2.8 lens (610g) are combined.

Common Sense Camera Care and Practice

The Mamiya RZ67 PRO II D is a precision optical/mechanical instrument, built for heavy professional use and a long service life, if properly treated and maintained. Please observe these basic caveats:

- Read instructions before using camera.
- Protect camera against shocks and falls. Use the neck strap supplied with it, whenever possible.
- Check the battery frequently and always carry spares. The sealed battery supplied with the camera may have been subject to storage conditions which have reduced its service life.
- Be sure to wipe battery contacts before installation and watch correct polarity.
- Battery life differs, depending on frequency of use, type, age, storage condition, ambient temperature (use External Battery Case in very cold weather), etc.
- Always remove the battery (and film) when camera is not used for a long period of time.
- Always keep covers on lenses and camera body.
- Do not store the camera at temperatures exceeding 40°C (105°F) and -10°C (15°F). Also avoid humid or sea air environment.
- Prolonged disuse shortens camera life. Periodically exercise the shutter (at different speeds, lens diaphragms and focusing mounts).
- Protect camera against rain and moisture.
- Do not touch lens surfaces. Use blower or lens tissue to remove dust particles.
- Always test your equipment before going on important assignments.

The Importance of Proper Maintenance

Your camera has mechanisms like film transport, shutter and diaphragm blades etc. They are controlled by gears, levers, springs, and so on. All require special lubrication from time to time. Ambient conditions can also affect these mechanisms, as well as the electronic components and the optical glass of your lenses. We therefore suggest that you have your camera and lenses checked, and if necessary serviced, periodically.