

# Panasonic®

## Operating Instructions

LCD Projector **Commercial Use**

Model No. **PT-F100NTE**  
**PT-F100E**

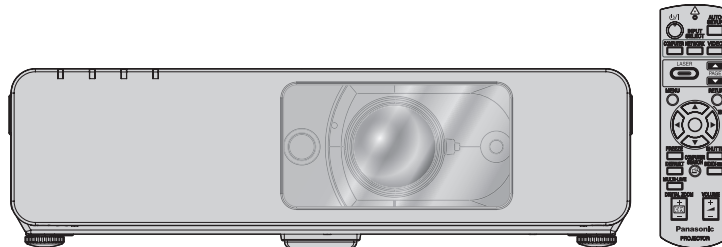

Before operating this product, please read the instructions carefully and save this manual for future use.

TQBJ0214-1

**ENGLISH**

# Important Safety Notice

## Dear Panasonic Customer:

This instruction booklet provides all the necessary operating information that you might require. We hope it will help you to get the most out of your new product, and that you will be pleased with your Panasonic LCD projector. The serial number of your product may be found on its bottom. You should note it in the space provided below and retain this booklet in case service is required.

Model number: **PT-F100NTE / PT-F100E**

Serial number:

**WARNING:** THIS APPARATUS MUST BE EARTHED.

**WARNING:** To prevent damage which may result in fire or shock hazard, do not expose this appliance to rain or moisture.

Machine Noise Information Ordinance 3. GSGV, January 18, 1991: The sound pressure level at the operator position is equal or less than 70 dB (A) according to ISO 7779.

**WARNING:**

1. Remove the plug from the mains socket when this unit is not in use for a prolonged period of time.
2. To prevent electric shock, do not remove cover. No user serviceable parts inside. Refer servicing to qualified service personnel.
3. Do not remove the earthing pin on the mains plug. This apparatus is equipped with a three prong earthing-type mains plug. This plug will only fit an earthing-type mains socket. This is a safety feature. If you are unable to insert the plug into the mains socket, contact an electrician. Do not defeat the purpose of the earthing plug.

**CAUTION:** To assure continued compliance, follow the attached installation instructions, which includes using the provided power cord and shielded interface cables when connecting to computer or peripheral device. If you use serial port to connect PC for external control of projector, you must use optional RS-232C serial interface cable with ferrite core. Any unauthorized changes or modifications to this equipment will void the user's authority to operate.

Pursuant to at the directive 2004/108/EC, article 9(2)  
Panasonic Testing Centre  
Panasonic Service Europe, a division of Panasonic Marketing Europe GmbH  
Winsberggring 15, 22525 Hamburg, F.R. Germany

### Information on Disposal for Users of Waste Electrical & Electronic Equipment (private households)



This symbol on the products and/or accompanying documents means that used electrical and electronic products should not be mixed with general household waste. For proper treatment, recovery and recycling, please take these products to designated collection points, where they will be accepted on a free of charge basis. Alternatively, in some countries you may be able to return your products to your local retailer upon the purchase of an equivalent new product. Disposing of this product correctly will help to save valuable resources and prevent any potential negative effects on human health and the environment which could otherwise arise from inappropriate waste handling. Please contact your local authority for further details of your nearest designated collection point. Penalties may be applicable for incorrect disposal of this waste, in accordance with national legislation.

### For business users in the European Union

If you wish to discard electrical and electronic equipment, please contact your dealer or supplier for further information.

### Information on Disposal in other Countries outside the European Union

This symbol is only valid in the European Union.

If you wish to discard this product, please contact your local authorities or dealer and ask for the correct method of disposal.

## Important Safety Information

### Declaration of Conformity



#### Declaration of Conformity (DoC)

This equipment is in compliance with the essential requirements and other relevant provisions of Directive 1999/5/EC.

Customers can download a copy of the original DoC for this product from our DoC server: <http://www.doc.panasonic.de>

Contact in the EU: Panasonic Services Europe, a Division of Panasonic Marketing Europe GmbH, Panasonic Testing Centre, Winsbergring 15, 22525 Hamburg, F.R.Germany

This product is intended to be used in the following countries.

Austria, Belgium, Bulgaria, Czech, Cyprus, Denmark, Estonia, Finland, France, Germany, Greece, Hungary, Iceland, Ireland, Italy, Latvia, Lithuania, Luxembourg, Malta, Netherlands, Norway, Poland, Portugal, Romania, Slovenia, Slovak, Spain, Sweden, Switzerland & UK



#### Konformitätserklärung (KE)

Dieses Gerät entspricht den grundlegenden Anforderungen und den weiteren entsprechenden Vorgaben der Richtlinie 1999/5/EU.

Kunden können eine Kopie der Original-KE für dieses Produkt von unserem KE-Server herunterladen: <http://www.doc.panasonic.de>

Kontaktadresse in der EG: Panasonic Services Europe, a Division of Panasonic Marketing Europe GmbH, Panasonic Testing Centre, Winsbergring 15, 22525 Hamburg, F.R.Germany

Dieses Produkt ist für den Einsatz in den folgenden Ländern vorgesehen.

Österreich, Belgien, Bulgarien, Tschechische Republik, Zypern, Dänemark, Estland, Finnland, Frankreich, Deutschland, Griechenland, Ungarn, Island, Irland, Italien, Lettland, Litauen, Luxemburg, Malta, Niederlande, Norwegen, Polen, Portugal, Rumänien, Slowenien, Slowakei, Spanien, Schweden, Schweiz und Großbritannien



#### Déclaration de Conformité (DC)

Cet appareil est conforme aux exigences essentielles et aux autres dispositions pertinentes de la Directive 1999/5/EC.

Les clients peuvent télécharger une copie de la DC originale pour ce produit à partir de notre serveur DC: <http://www.doc.panasonic.de>

Coordonnées dans l'UE : Panasonic Services Europe, a Division of Panasonic Marketing Europe GmbH, Panasonic Testing Centre, Winsbergring 15, 22525 Hamburg, F.R.Germany

Ce produit est conçu pour l'utilisation dans les pays suivants.

Autriche, Belgique, Bulgarie, République Tchèque, Chypre, Danemark, Estonie, Finlande, France, Allemagne, Grèce, Hongrie, Islande, Irlande, Italie, Lettonie, Lituanie, Luxembourg, Malte, Pays-Bas, Norvège, Pologne, Portugal, Roumanie, Slovénie, Slovaquie, Espagne, Suède, Suisse et Royaume-Uni



#### Declaración de conformidad (DC)

Este equipo cumple con los requisitos esenciales así como con otras disposiciones de la Directiva 1999/5/CE.

El cliente puede descargar una copia de la DC original de este producto desde nuestro servidor DC: <http://www.doc.panasonic.de>

Contacto en la U.E.: Panasonic Services Europe, a Division of Panasonic Marketing Europe GmbH, Panasonic Testing Centre, Winsbergring 15, 22525 Hamburg, F.R.Germany

Este producto ha sido desarrollado para el uso en los siguientes países.

Austria, Bélgica, Bulgaria, República Checa, Chipre, Dinamarca, Estonia, Finlandia, Francia, Alemania, Grecia, Hungría, Islandia, Irlanda, Italia, Letonia, Lituania, Luxemburgo, Malta, Holanda, Noruega, Polonia, Portugal, Rumania, Eslovenia, Eslovaquia, España, Suecia, Suiza y el Reino Unido



#### Dichiarazione di conformità (DoC)

Questo apparato è conforme ai requisiti essenziali ed agli altri principi sanciti dalla Direttiva 1999/5/CE.

I clienti possono scaricare la copia del DoC originale per questo prodotto dal nostro server DoC: <http://www.doc.panasonic.de>

Contatto nella EU: Panasonic Services Europe, a Division of Panasonic Marketing Europe GmbH, Panasonic Testing Centre, Winsbergring 15, 22525 Hamburg, F.R.Germany

I prodotti sono stati prodotti per l'uso nei seguenti paesi.

Austria, Belgio, Bulgaria, Repubblica Ceca, Cipro, Danimarca, Estonia, Finlandia, Francia, Germania, Grecia, Irlanda, Islanda, Italia, Lettonia, Lituania, Lussemburgo, Malta, Olanda, Norvegia, Polonia, Portogallo, Romania, Regno Unito, Slovenia, Slovacchia, Spagna, Svezia, Svizzera, Ungheria

## България

Това устройство отговаря на съществените изисквания и останалите приложими разпоредби на Директива 1999/5/ЕО.

## Česky

Toto zařízení je v souladu se základními požadavky a ostatními odpovídajícími ustanoveními Směrnice 1999/5/EC.

## Dansk

Dette udstyr er i overensstemmelse med de væsentlige krav og andre relevante bestemmelser i Direktiv 1999/5/EF.

## Eesti

See seade vastab direktiivi 1999/5/EÜ olulistele nõuetele ja teistele asjakohastele sätetele.

## Ελληνική

Αυτός ο εξοπλισμός είναι σε συμμόρφωση με τις ουσιώδεις απαιτήσεις και άλλες σχετικές διατάξεις της Οδηγίας 1999/5/ΕΚ.

## Íslenska

Þetta tæki er samkvæmt grunnkröfum og öðrum viðeigandi ákvæðum Tilskipunar 1999/5/EC.

## Latviski

Šī iekārta atbilst Direktīvas 1999/5/EK būtiskajām prasībām un citiem ar to saistītajiem noteikumiem.

## Lietuvių

Šis įrenginys tenkina 1999/5/EB Direktyvos esminius reikalavimus ir kitas šios direktyvos nuostatas.

## Nederlands

Dit apparaat voldoet aan de essentiële eisen en andere van toepassing zijnde bepalingen van de Richtlijn 1999/5/EC.

## Malti

Dan I-apparat huwa konformi mal-ħtiġiet essenzjali u I-provedimenti I-oħra rilevanti tad-Direttiva 1999/5/EC.

## Magyar

Ez a készülék teljesíti az alapvető követelményeket és más 1999/5/EK irányelvben meghatározott vonatkozó rendelkezéseket.

## Norsk

Dette utstyret er i samsvar med de grunnleggende krav og andre relevante bestemmelser i EU-direktiv 1999/5/EF.

## Polski

Urządzenie jest zgodne z ogólnymi wymaganiami oraz szczególnymi warunkami określonymi Dyrektywą UE: 1999/5/EC.

## Português

Este equipamento está em conformidade com os requisitos essenciais e outras provisões relevantes da Directiva 1999/5/EC.

## România

Acest echipament este conform cu cerințele de bază și celelalte prevederi relevante ale Directivei 1999/5/CE.

## Slovensko

Ta naprava je skladna z bistvenimi zahtevami in ostalimi relevantnimi pogoji Direktive 1999/5/EC.

## Slovensky

Toto zariadenie je v zhode so základnými požiadavkami a inými príslušnými nariadeniami direktív: 1999/5/EC.

## Suomi

Tämä laite täyttää direktiivin 1999/5/EY olennaiset vaatimukset ja on siinä asetettujen muiden laitetta koskevien määräysten mukainen.

## Svenska

Denna utrustning är i överensstämmelse med de väsentliga kraven och andra relevanta bestämmelser i Direktiv 1999/5/EC.

# Contents

## Quick steps

**1. Set up your projector**  
See “Setting up” on page 16.



**2. Connect with other devices**  
See “Connections” on page 20.



**3. Prepare the Remote control**  
See “Remote control” on page 13.



**4. Start projecting**  
See “Switching the projector on/off” on page 22.



**5. Adjust the image**  
See “Menu Navigation” on page 29.

- When you start the projection for the first time, the minimum required setting screen for projection will be displayed. See “Minimum required setting screen” on page 12.

## Important Information

<b>Important Safety Notice</b> .....	<b>2</b>
Declaration of Conformity .....	4
<b>Precautions with regard to safety</b> .....	<b>8</b>
WARNINGS .....	8
CAUTIONS .....	9
Cautions when transporting .....	10
Cautions when installing .....	10
Cautions on use .....	11
Accessories .....	11

## Preparation

<b>Read this first</b> .....	<b>12</b>
Minimum required setting screen .....	12
<b>About Your Projector</b> .....	<b>13</b>
Remote control .....	13
Projector body .....	14

## Getting Started

<b>Setting up</b> .....	<b>16</b>
Screen size and throw distance .....	16
Projection method .....	17
Front leg adjusters and throwing angle .....	17
Lens shift and positioning .....	18
<b>Connections</b> .....	<b>20</b>
Before connection to the projector .....	20
Connecting with computers .....	20
Connecting with AV equipment .....	21

## Basic Operation

<b>Switching the projector on/off</b> .....	<b>22</b>
Mains lead .....	22
POWER indicator .....	22
Switching on the projector .....	23
Switching off the projector .....	23
<b>Projecting an image</b> .....	<b>24</b>
Selecting the input signal .....	24
Positioning the image .....	24
<b>Remote control operation</b> .....	<b>25</b>
Operating range .....	25
Setting up the image position automatically .....	25
Switching the input signal .....	26
Using the laser pointer .....	26
Capturing an image .....	27
Stopping the projection temporary .....	27
Resetting to the factory default settings .....	27
Projecting an image in INDEX-WINDOW mode .....	27
Enlarging the centred area .....	28
Controlling the volume of the speaker .....	28

## Settings

<b>Menu Navigation</b> .....	<b>29</b>
Navigating through the MENU .....	29
Main menu and Sub-menu .....	30
<b>PICTURE menu</b> .....	<b>32</b>
PICTURE MODE .....	32
CONTRAST .....	32
BRIGHTNESS .....	32
COLOR .....	32
TINT .....	32
SHARPNESS .....	32
COLOR TEMPERATURE .....	32
DAYLIGHT VIEW .....	32
DETAILED SETUP .....	33
<b>POSITION menu</b> .....	<b>34</b>
KEYSTONE .....	34
POSITION .....	34
DOT CLOCK .....	34
CLOCK PHASE .....	34
ASPECT .....	34
RESIZING .....	35
FRAME LOCK .....	35
<b>OPTION menu</b> .....	<b>36</b>
INPUT GUIDE .....	36
STARTUP LOGO .....	36
COMPUTER2 SELECT .....	36
FILTER SETUP .....	36
FILTER REMAINING .....	36
LAMP RUNTIME .....	37
POWER OFF TIMER .....	37
DIRECT POWER ON .....	37
CONTROL PANEL .....	37
AUTO SETUP .....	37
SIGNAL SEARCH .....	37
INSTALLATION .....	37
HIGHLAND .....	38
TEST PATTERN .....	38
DETAILED SETUP .....	38
<b>SECURITY menu</b> .....	<b>39</b>
INPUT PASSWORD .....	39
PASSWORD CHANGE .....	39
TEXT DISPLAY .....	39
TEXT CHANGE .....	39
<b>NETWORK menu</b> .....	<b>40</b>
Items in NETWORK menu .....	40

## Maintenance

<b>TEMP, LAMP and FILTER Indicators</b> .....	<b>41</b>
Managing the indicated problems .....	41
<b>Care and Replacement</b> .....	<b>42</b>
Cleaning the projector .....	42
Replacing the ARF (Auto Rolling Filter) .....	42
Replacing the Lamp unit .....	43
Ceiling mount bracket safeguards .....	44
<b>Troubleshooting</b> .....	<b>45</b>

## Appendix

<b>Technical Information</b> .....	<b>46</b>
List of compatible signals .....	46
Serial terminal .....	47
Computer connection guidance .....	48
REMOTE terminal .....	49
Specifications .....	50
Screen size and throw distance for 16:9 aspect ratio .....	52
Dimensions .....	53
Trademark acknowledgements .....	53
<b>Index</b> .....	<b>54</b>

Important Information

Preparation

Getting Started

Basic Operation

Settings

Maintenance

Appendix

# Precautions with regard to safety

## WARNINGS

**If you notice smoke, strange smells or noise coming from the projector, disconnect the mains plug from the mains socket.**

- Do not continue to use the projector in such cases, otherwise fire or electric shocks could result.
- Check that no more smoke is coming out, and then contact an Authorised Service Centre for repairs.
- Do not attempt to repair the projector yourself, as this can be dangerous.

**Do not install this projector in a place which is not strong enough to take the full weight of the projector.**

- If the installation location is not strong enough, it may fall down or tip over, and severe injury or damage could result.

**Installation work (such as ceiling suspension) should only be carried out by a qualified technician.**

- If installation is not carried out correctly, there is the danger that injury or electric shocks may occur.
- Do not use other than an authorised ceiling mount bracket.

**If foreign objects or water get inside the projector, or if the projector is dropped or the cabinet is broken, disconnect the mains plug from the mains socket.**

- Continued use of the projector in this condition may result in fire or electric shocks.
- Contact an Authorised Service Centre for repairs.

**Do not overload the mains socket.**

- If the power supply is overloaded (for example, by using too many adapters), overheating may occur and fire may result.

**Never attempt to modify or disassemble the projector.**

- High voltages can cause fire or electric shocks.
- For any inspection, adjustment and repair work, please contact an Authorised Service Centre.

**Clean the mains plug regularly to prevent it from becoming covered in dust.**

- If dust builds up on the mains plug, the resulting humidity can damage the insulation, which could result in fire. Pull the mains plug out from the mains socket and wipe it with a dry cloth.
- If not using the projector for an extended period of time, pull the mains plug out from the mains socket.

**Do not handle the mains plug with wet hands.**

- Failure to observe this may result in electric shocks.

**Insert the mains plug securely into the mains socket.**

- If the plug is not inserted correctly, electric shocks or overheating could result.
- Do not use plugs which are damaged or mains sockets which are coming loose from the wall.

**Do not place the projector on top of surfaces which are unstable.**

- If the projector is placed on top of a surface which is sloped or unstable, it may fall down or tip over, and injury or damage could result.

**Do not place the projector into water or let it become wet.**

- Failure to observe this may result in fire or electric shocks.

**Do not do anything that might damage the mains lead or the mains plug.**

- Do not damage the mains lead, make any modifications to it, place it near any hot objects, bend it excessively, twist it, pull it, place heavy objects on top of it or wrap it into a bundle.
- If the mains lead is used while damaged, electric shocks, short-circuits or fire may result.
- Ask an Authorised Service Centre to carry out any repairs to the mains lead that might be necessary.

**Do not place the projector on soft materials such as carpets or sponge mats.**

- Doing so may cause the projector to overheat, which can cause burns, fire or damage to the projector.

**Do not place liquid containers on top of the projector.**

- If water spills onto the projector or gets inside it, fire or electric shocks could result.
- If any water gets inside the projector, contact an Authorised Service Centre.

**Do not insert any foreign objects into the projector.**

- Do not insert any metal objects or flammable objects into the projector or drop them onto the projector, as doing so can result in fire or electric shocks.

**Do not allow the + and - terminals of the batteries to come into contact with metallic objects such as necklaces or hairpins.**

- Failure to observe this may cause the batteries to leak, overheat, explode or catch fire.
- Store the batteries in a plastic bag and keep them away from metallic objects.

**Do not touch the leaked liquid from the batteries.**

- If you touch the leaked liquid, it may hurt your skin. Immediately wash away the liquid with water and seek medical advice.
- If you get the leaked liquid in your eye, it may cause blindness or damage. Never rub your eye, and immediately wash away the liquid with water and seek medical advice.

**During a thunderstorm, do not touch the projector or the cable.**

- Electric shocks can result.

## Precautions with regard to safety

### Do not use the projector in a bath or shower.

- Fire or electric shocks can result.

### Do not place your skin into the light beam while the projector is being used.

- Strong light is emitted from the projector's lens. If you place directly into this light, it can hurt or damage your skin.

### Do not look into the lens while the projector is being used.

- Strong light is emitted from the projector's lens. If you look directly into this light, it can hurt and damage your eyes.
- Be especially careful not to let young children look into the lens. In addition, turn off the power and disconnect the mains plug when you are away from the projector.

### Do not place your hands or other objects close to the air outlet port.

- Heated air comes out of the air outlet port. Do not place your hands or face, or objects which cannot withstand heat close to this port [allow at least 50 cm (20") of space], otherwise burns or damage could result.

### Replacement of the lamp is recommended to be carried out by a qualified technician.

- The lamp has high internal pressure. If improperly handled, explosion might result.
- The lamp can easily become damaged if struck against hard objects or dropped, and injury or malfunctions may result.

### When replacing the lamp, allow it to cool for at least one hour before handling it.

- The lamp cover gets very hot, and touching it can cause burns.

### Before replacing the lamp, be sure to disconnect the mains plug from the mains socket.

- Electric shocks or explosions can result if this is not done.

### Do not allow infants or pets to touch the remote control unit.

- Keep the remote control unit out of the reach of infants and pets after using it.

## CAUTIONS

### Do not cover the air inlet port or the air outlet port.

- Doing so may cause the projector to overheat, which can cause fire or damage to the projector.
- Do not place the projector in narrow, badly ventilated places such as closets or bookshelves.
- Do not place the projector on cloth or papers, as these materials could be drawn into the air inlet port.

### Do not set up the projector in humid or dusty places or in places where the projector may come into contact with oily smoke or steam.

- Using the projector under such conditions may result in fire, electric shocks or plastic deterioration. The plastic deterioration may cause the falling down of the projector which is mounted in the ceiling.

### Do not set up the projector in a high temperature environment, such as near a heater or in direct sunlight.

- Failure to observe this may result in fire, malfunction or plastic deterioration.

### Do not set up the projector outdoors.

- The projector is designed for indoor use only.

### When disconnecting the mains lead, hold the plug, not the lead.

- If the mains lead itself is pulled, the lead will become damaged, and fire, short-circuits or serious electric shocks may result.

### Always disconnect all cables before moving the projector.

- Moving the projector with cables still attached can damage the cables, which could cause fire or electric shocks to occur.

### Do not place any heavy objects on top of the projector.

- Failure to observe this may cause the projector to become unbalanced and fall, which could result in damage or injury.

### Do not short-circuit, heat or disassemble the batteries or place them into water or fire.

- Failure to observe this may cause the batteries to overheat, leak, explode or catch fire, and burns or other injury may result.

### When inserting the batteries, make sure the polarities (+ and -) are correct.

- If the batteries are inserted incorrectly, they may explode or leak, and fire, injury or contamination of the battery compartment and surrounding area may result.

### Use only the specified batteries.

- If incorrect or different kind of batteries are used, they may explode or leak, and fire, injury or contamination of the battery compartment and surrounding area may result.

## Precautions with regard to safety

### Do not mix old and new batteries.

- If the batteries are inserted incorrectly, they may explode or leak, and fire, injury or contamination of the battery compartment and surrounding area may result.

### Remove the used batteries from the remote control promptly.

- If you leave used batteries in the remote control for an extended period of time, it may cause liquid leaking, abnormal internal temperature rising or explosion.

### If not using the projector for an extended period of time, disconnect the mains plug from the mains socket and remove the batteries from the remote control.

- If dust builds up on the mains plug, the resulting humidity may damage the insulation, which could result in fire.
- Keeping or leaving the remote control with batteries inside may cause insulation deterioration, electrical leakage or explosion which could result in fire.

### Do not put your weight on this projector.

- You could fall or the projector could break, and injury may result.
- Be especially careful not to let young children stand or sit on the projector.

We are constantly making efforts to preserve and maintain a clean environment. Please take non repairable units back to your dealer or a recycling company.

### Disconnect the mains plug from the mains socket as a safety precaution before carrying out any cleaning.

- Electric shocks can result if this is not done.

### If the lamp has broken, ventilate the room immediately. Do not touch or bring your face close to the broken pieces.

- Failure to observe this may cause the user to absorb the gas which was released when the lamp broke and which contains nearly the same amount of mercury as fluorescent lamps, and the broken pieces may cause injury.
- If you believe that you have absorbed the gas or that the gas has got into your eyes or mouth, seek medical advice immediately.
- Ask your dealer about the replacement of the lamp unit and check the inside of the projector.

### Ask an Authorised Service Centre to clean inside the projector at least once a year.

- If dust is left to build up inside the projector without being cleaned out, it can result in fire or problems with operation.
- It is a good idea to clean the inside of the projector before the season for humid weather arrives. Ask your nearest Authorised Service Centre to clean the projector when required. Please discuss with the Authorised Service Centre regarding cleaning costs.

## Cautions when transporting

### Do not subject the projector to excessive vibration or shocks.

- The projector lens need to be handled with care.
- Cover the lens with the lens cover when transporting the projector.

### When transporting the projector, hold the body at the bottom securely.

- Do not hold the adjuster legs or the top cover to move the projector, as this may damage the projector.

## Cautions when installing

### Avoid setting up in places which are subject to vibration or shocks.

- The internal parts can be damaged, which may cause malfunctions or accidents.

### Avoid setting up in places which are subject to sudden temperature changes, such as near an air conditioner or lighting equipment.

- The life of the lamp may be shortened or the projector may be turned off. See "TEMP indicator" on page 41.

### Do not set up the projector near high-voltage power lines or near motors.

- The projector may be subject to electromagnetic interference.

### If installing the projector to the ceiling, ask a qualified technician to carry out all installation work.

- You will need to purchase the separate installation kit (Model No. ET-PKF100H, ET-PKF100S). Furthermore, all installation work is should only be carried out by a qualified technician.
- See "Ceiling mount bracket safeguards" on page 44 for the **Safety cable** installation.

### If using this projector at high elevations (above 1 400 m), set the HIGHLAND to ON. See "HIGHLAND" on page 38.

- Failure to observe this may result in malfunctions or the life of the lamp or the other components may be shortened.

## Cautions on use

### In order to get the best picture quality

- Draw curtains or blinds over any windows and turn off any lights near the screen to prevent outside light or light from indoor lamps from shining onto the screen.

### Do not touch the surfaces of the lens or the front glass with your bare hands.

- If the surface of the lens becomes dirty from fingerprints or anything else, this will be magnified and projected onto the screen. Moreover, when not using the projector, close the **Front panel cover**.

### Liquid crystal panel

- Do not project the same image for long periods of time, as this may remain as an afterimage on the liquid crystal panel.
- The liquid crystal panel of the projector is built with very high precision technology to provide fine picture details. Occasionally, a few stuck pixels may appear on the screen as fixed points of blue, green or red. It is recommended to switch off the projector once and try after 1 hour later again. Please note that this does not affect the performance of your LCD.

### The projector has a high pressure mercury lamp and that is characterised as follows.

- The brightness of the lamp depends on the duration of use.
- The lamp may explode or shorten the lamp life by shocks or chipping damage.
- The lamp may explode only occasionally after using the projector.
- The lamp may explode if using the projector after the instructed lamp replacement timing.
- The lamp life is depends on individual lamp characteristics, usage condition and the installation environment. Especially the consecutive use of the projector for more than 10 hours, or the frequent switching on or off may greatly affect on the lamp life.

### Screen



- Do not apply any volatile substances which may cause discolouration to the screen, and do not let it become dirty or damaged.

### Optical components

- If you use the projector consecutively 6 hours every day, the optical components may need to be replaced in less than 1 year.

## Accessories

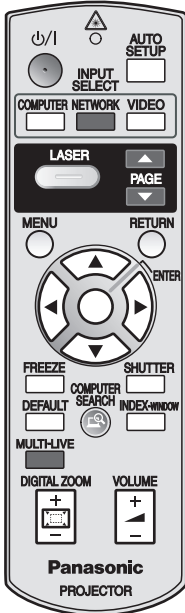
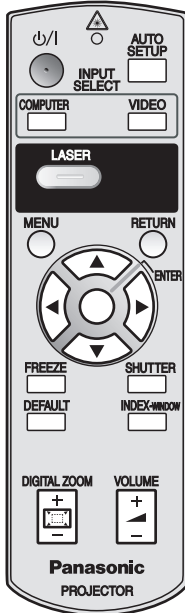
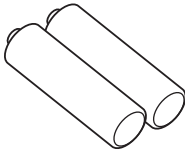
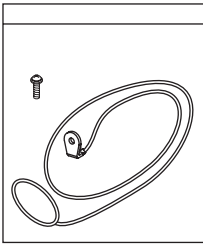
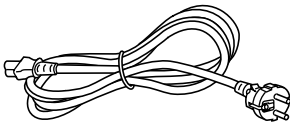
Make sure the following accessories are provided with your projector.

<p><b>Remote control for PT-F100NTE*<sup>1</sup> (x1)</b> N2QAYB000152</p> 	<p><b>Remote control for PT-F100E*<sup>2</sup> (x1)</b> N2QAYB000154</p> 	<p><b>AA batteries for Remote control (x2)</b></p> 	<p><b>Safety cable TTRA0141</b> Attachment screw (x1) Safety cable (x1)</p> 
		<p><b>Mains lead (x1)</b> K2CM3DH00015</p> 	<p><b>CD-ROM*<sup>3</sup> (x1)</b> TQBH9009</p> 

\*1. PT-F100NTE only

\*2. PT-F100E only

\*3. PT-F100NTE only

\* The protectors for enclosed products, such as a plug cover or foam cartons, must be treated properly.

# Read this first

## Minimum required setting screen

When you start the projection for the first time, the minimum required setting screen for projection will be displayed.

### LANGUAGE

Select the required language setting.

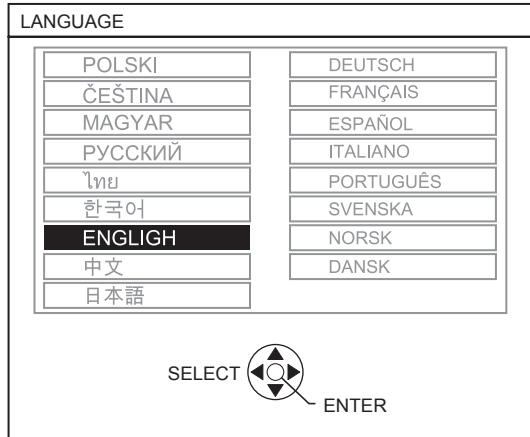

Press ▲ ▼ ◀ ▶ buttons of the **Remote control** or **Control panel** on the projector to highlight the required language, and press **ENTER** to proceed to the next setting.

### OPTION

Select the current projection method and fan speed setting. If you need return to the previous setting, press the **RETURN** button.

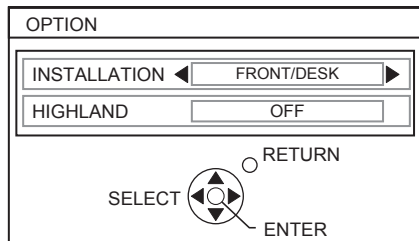

**Press the ENTER button to start the projection.**

- Once you finish the minimum requirement setting, it will not be displayed again unless the projector is initialised. See “INITIALIZE ALL” on page 38.
- You can change the settings from the **MAIN MENU**. See “Menu Navigation” on page 29.

### INSTALLATION

Press ◀ ▶ buttons of the **Remote control** or **Control panel** on the projector to select the required installation method. Press ▼ to proceed to the **HIGHLAND** setting.

<b>FRONT/DESK</b>	Setting on a desk/floor and projecting from front
<b>FRONT/CEILING</b>	Mounting in the ceiling and projecting from front
<b>REAR/DESK</b>	Setting on a desk/floor and projecting from rear
<b>REAR/CEILING</b>	Mounting in the ceiling and projecting from rear

### HIGHLAND

If you use the projector at high elevation, the **HIGHLAND** setting need to be **ON** to set the fan speed high. Press ◀ ▶ to select the required option. If you need to return to the **INSTALLATION**, press ▲.

- **OFF** The fan speed is low.
- **ON** The fan speed is high.

### NOTE:

- At 1 400 m (4 593 ft) above sea level, the setting must be **ON**.
- The loudness of fan noise depends on the **HIGHLAND** setting.

# About Your Projector

## Remote control

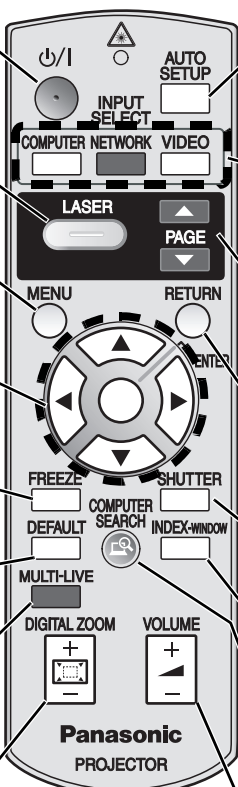

**POWER button**  
While the **MAIN POWER** is on, switch between stand-by mode and projection mode. (page 22)

**Project a laser pointer.** (page 26)

**Display the MAIN MENU.** (page 29)

Navigate through the menus with **▲▼◀▶**, and activate the menu item with **ENTER**. (page 29)

Capture the projected image as a frozen picture. (page 27)

Reset some of the settings to the factory default settings. (page 27)

- **MULTI-LIVE** is only for PT-F100NTE.
- See **CD-ROM** contents.

Control to change the scale by means of digital zoom. (page 28)

**VOLUME** Control to adjust the volume of the speakers. (page 28)

**AUTO SETUP** Automatically adjust the setting of **DOT CLOCK**, **CLOCK PHASE** and **SIGNAL SEARCH** for the projected image of **COMPUTER** signal. (page 25)

**COMPUTER INPUT SELECT buttons**  
Switch the required input signal button to select.  
● **NETWORK** button is only for PT-F100NTE.  
● See **CD-ROM** contents.

- **PAGE** buttons are only for PT-F100NTE.
- See **CD-ROM** contents.

**RETURN** Return to the previous menu. (page 29)

**SHUTTER** Turn off the projection temporarily.

**INDEX-WINDOW** Display the frozen image while the display of subsequent images continues. (page 27)

- **COMPUTER SEARCH** button is only for PT-F100NTE.
- See **CD-ROM** contents.

### Battery compartment

1. Press the tab and lift up the cover.
2. Insert the batteries according to the polarity diagram indicated inside.



### Top view

Remote control signal and Laser pointer beam emitters. (page 25)

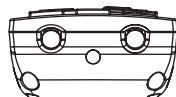

### Attaching a hand strap

You can attach a favourite strap on to the **Remote control**.

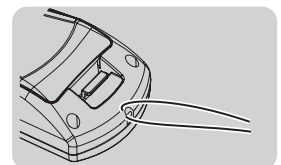

### Remote control indicator

If you press any button except the **LASER** button, the **Remote control indicator** will flash. If you press the **LASER** button, it will lit.

### Remote control indicator

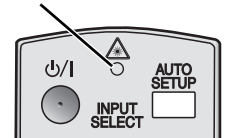

### NOTE:

- Do not drop the **Remote control**.
- Avoid contact with liquids or moisture.
- Use manganese batteries or alkaline batteries with the **Remote control**.
- Do not attempt to modify or disassemble the **Remote control**. Contact an Authorised Service Centre for repairs.
- Do not keep pressing the **Remote control** buttons as this may shorten battery life.
- Do not point the laser in other people's eyes or stare into beam.
- See "Remote control operation" on page 25.

## Projector body

### Top and front view

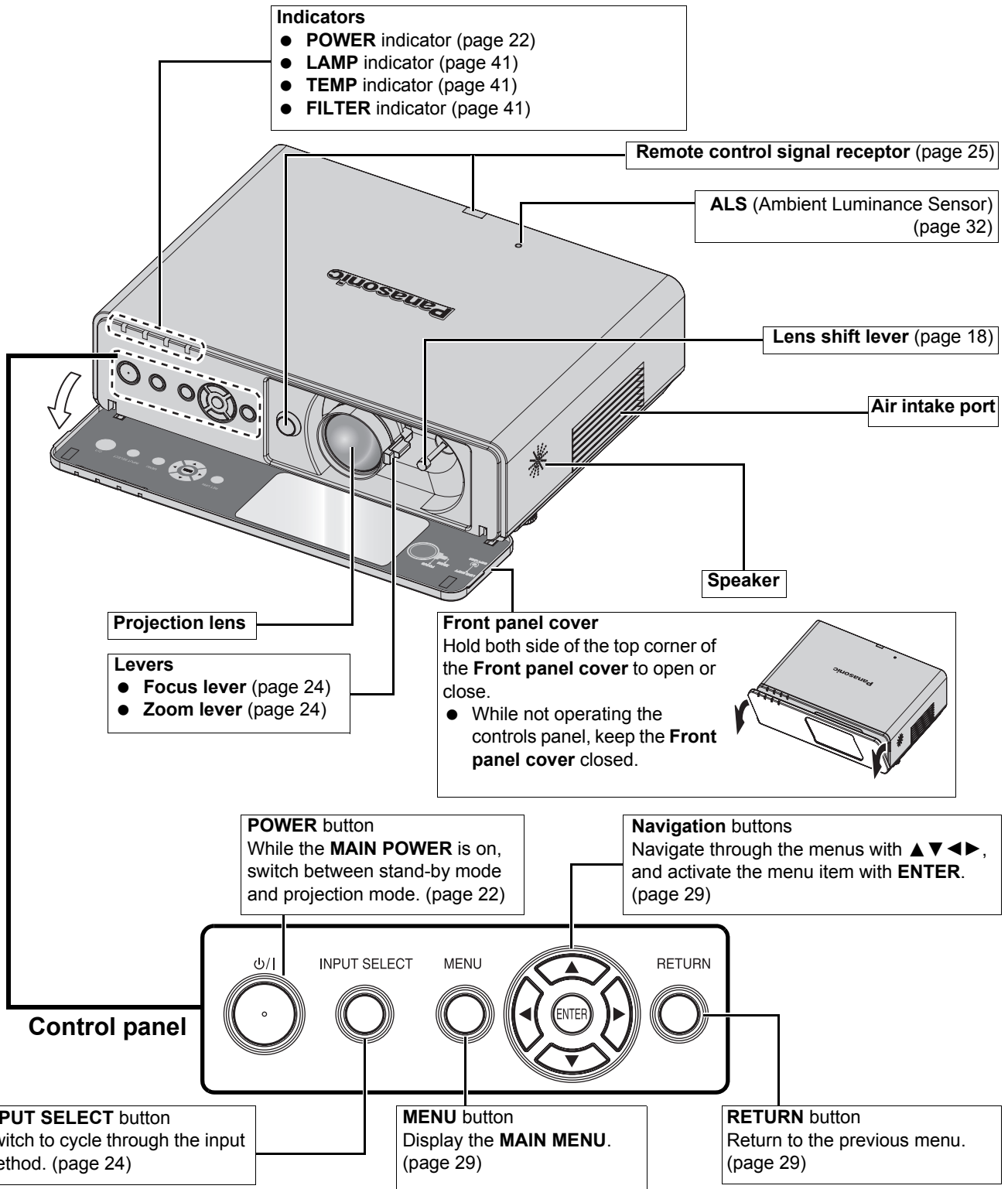

**NOTE:**

- Do not cover the ventilation openings or place anything within 50 cm (20") of them as this may cause damage or injury.
- While the projector is not in use, keep the **FRONT PANEL COVER** closed to protect the lens.

**Back and bottom view**

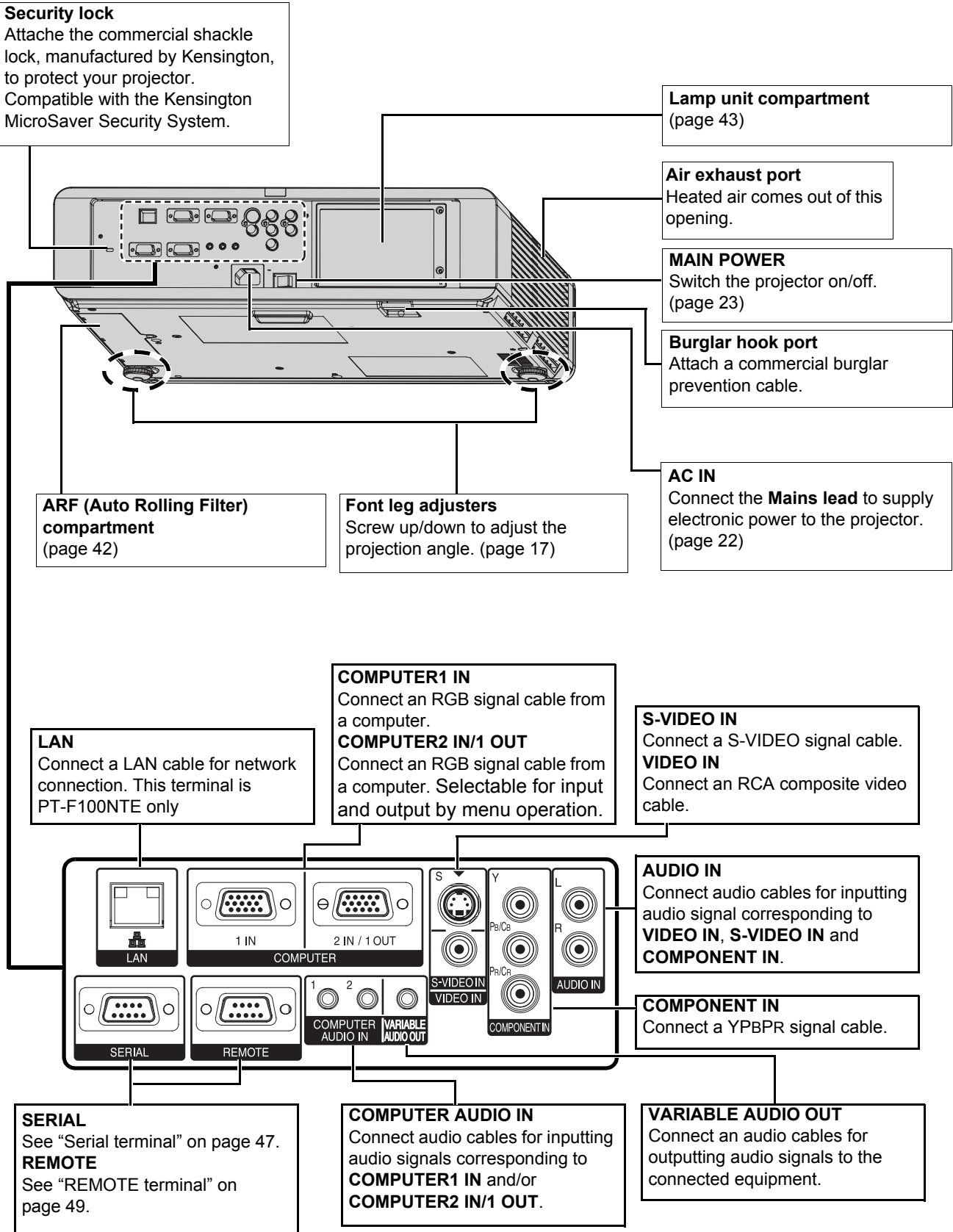

**NOTE:**

- Do not cover the ventilation openings or place anything within 50 cm (20") of them as this may cause damage or injury.
- When a cable is connected to the **VARIABLE AUDIO OUT**, the built-in speaker will be disabled.

# Setting up

## Screen size and throw distance

You can adjust the projection size with 2.0x zoom lens. Calculate and define the throw distance as follows.

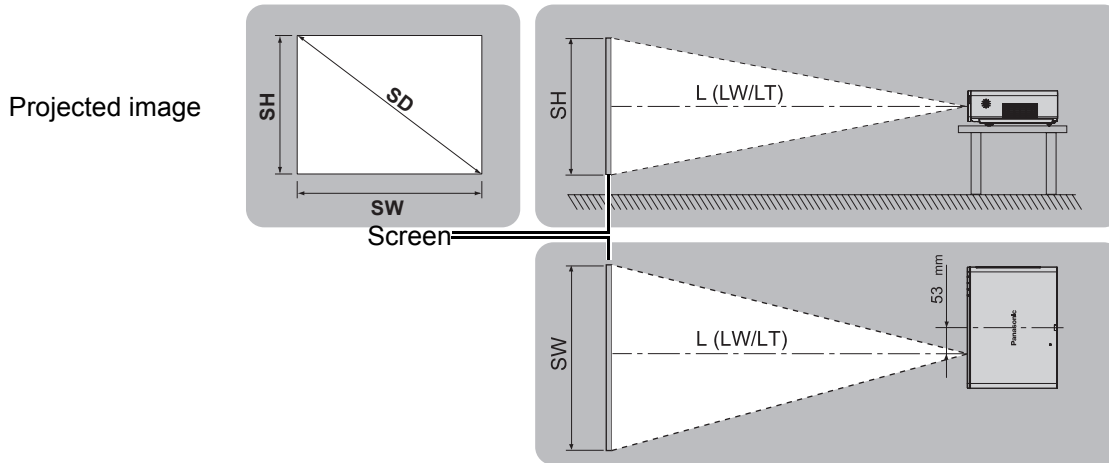

Getting Started

Projection size (4 : 3)			Throw distance (L)	
Screen diagonal (SD)	Screen height (SH)	Screen width (SW)	Minimum distance (LW)	Maximum distance (LT)
33" (0.84 m)	0.50 m (1'7")	0.67 m (2'2")		1.9 m (6'2")
40" (1.02 m)	0.61 m (2')	0.81 m (2'7")	1.2 m (3'11")	2.4 m (7'10")
50" (1.27 m)	0.76 m (2'5")	1.02 m (3'4")	1.5 m (4'11")	3.0 m (9'10")
60" (1.52 m)	0.91 m (2'11")	1.22 m (4')	1.8 m (5'10")	3.6 m (11'9")
70" (1.78 m)	1.07 m (3'06")	1.42 m (4'7")	2.1 m (6'10")	4.2 m (13'9")
80" (2.03 m)	1.22 m (4')	1.63 m (5'4")	2.4 m (7'10")	4.8 m (15'8")
90" (2.29 m)	1.37 m (4'5")	1.83 m (6')	2.7 m (8'10")	5.4 m (17'8")
100" (2.54 m)	1.52 m (4'11")	2.03 m (6'7")	3.0 m (9'10")	6.0 m (19'8")
120" (3.05 m)	1.83 m (6')	2.44 m (8')	3.6 m (11'9")	7.2 m (23'7")
150" (3.81 m)	2.29 m (7'6")	3.05 m (10')	4.5 m (14'9")	9.0 m (29'6")
200" (5.08 m)	3.05 m (10')	4.06 m (13'3")	6.0 m (19'8")	12.1 m (39'8")
250" (6.35 m)	3.81 m (12'6")	5.08 m (16'8")	7.6 m (24'11")	15.1 m (49'6")
300" (7.62 m)	4.57 m (14'11")	6.10 m (20')	9.1 m (29'10")	18.1 m (59'4")

\* All measurements above are approximate and may differ slightly from the actual measurements.

### Calculation methods for screen dimensions

You can calculate more detailed screen dimension from the screen diagonal.

$$SW (m) = SD (") \times 0.0203$$

$$SH (m) = SD (") \times 0.0152$$

$$LW (m) = 0.0304 \times SD (") - 0.048$$

$$LT (m) = 0.0606 \times SD (") - 0.057$$

\* The results above are approximate and may differ slightly from the actual measurements.

#### NOTE:

- See "Screen size and throw distance for 16:9 aspect ratio" on page 52.
- Do not use the projector at a raised or a horizontally tilted position as it may cause malfunction of the projector.
- Make sure the projector lens surface is parallel with the screen. You can tilt the projector body approximately  $\pm 30^\circ$  vertically. Overtilting may result in shortening the component's life.
- For the best quality of the projection image, install a screen where sun light or room light does not shine directly onto the screen. Close window shades or curtains to block the lights.

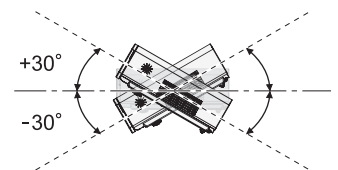

## Projection method

You can use the projector with any of the following 4 projection methods. To set the desired method in the projector, See "INSTALLATION" on page 37.

### ■ Setting on a desk/floor and projecting from front

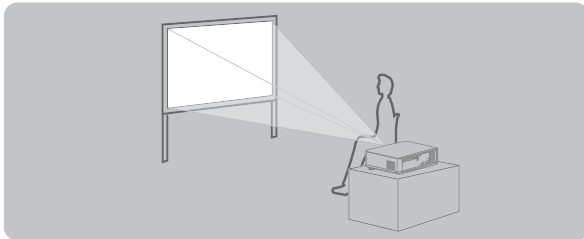

INSTALLATION: FRONT/DESK

### ■ Setting on a desk/floor and projecting from rear

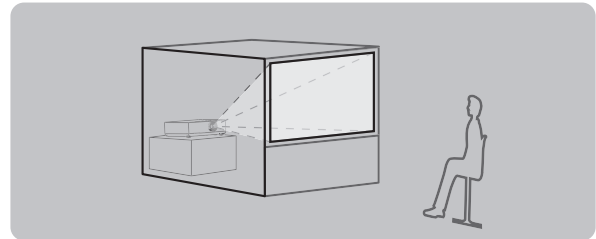

INSTALLATION: REAR/DESK

### ■ Mounting in the ceiling and projecting from front

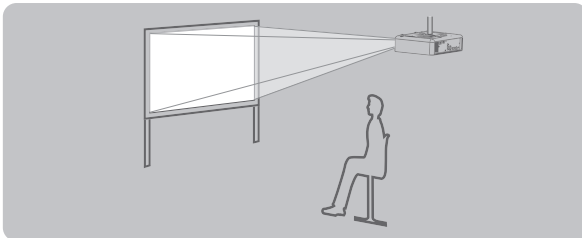

INSTALLATION: FRONT/CEILING

### ■ Mounting in the ceiling and projecting from rear

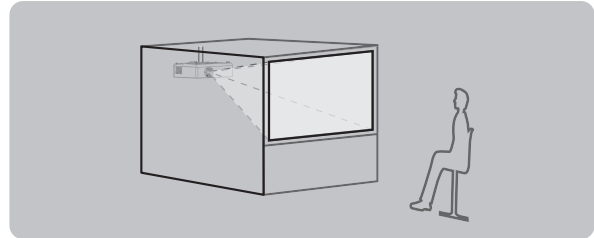

INSTALLATION: REAR/CEILING

#### NOTE:

- A translucent screen is required for rear projection.
- When mounting the projector in the ceiling, the optional ceiling mount bracket (ET-PKF100H, ET-PKF100S) is required.
- See "Ceiling mount bracket safeguards" on page 44.

## Front leg adjusters and throwing angle

You can screw up/down the front leg adjusters to control the angle of the projector for adjusting the throwing angle. See "Positioning the image" on page 24.

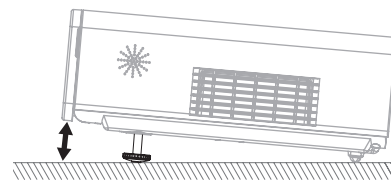
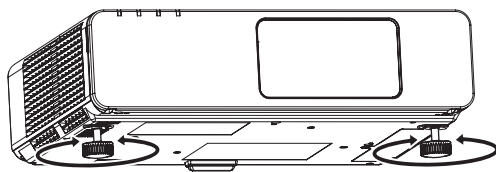

#### NOTE:

- Heated air comes out of the **Air exhaust port**. Do not touch the **Air exhaust port** directly.
- If keystone distortion occurs, see "KEYSTONE" on page 34.

## Lens shift and positioning

If the projector is not positioned right in front of the centre of the screen, you can adjust the projected image position by moving the **Lens shift lever** within the shift range of the lens.

### ■ Adjusting the Lens shift lever

1. Open the **Front panel cover**.
2. Screw the **Lens shift lever** counterclockwise to unlock.
3. Move the **Lens shift lever** to adjust the projected image position.
4. Screw the **Lens shift lever** clockwise to lock.

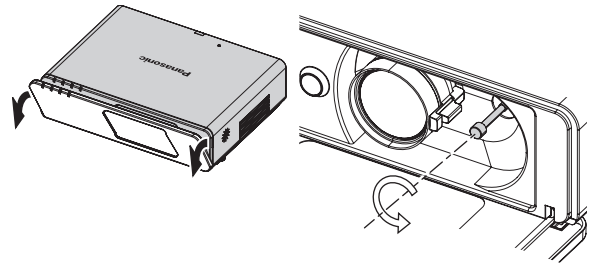

### ● Horizontal shift

You can place the projector where the projector lens is up to 32% horizontally off-centre from the screen and then adjust the image position with the **Lens shift lever**.

Up to about 32 % of the projection

Up to about 32 % of the projection

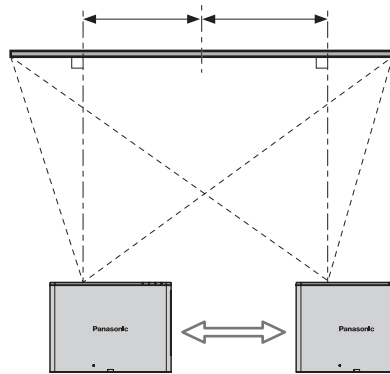

Shifting the lever right:  
Moving to screen's right.

Shifting the lever left:  
Moving to screen's left.

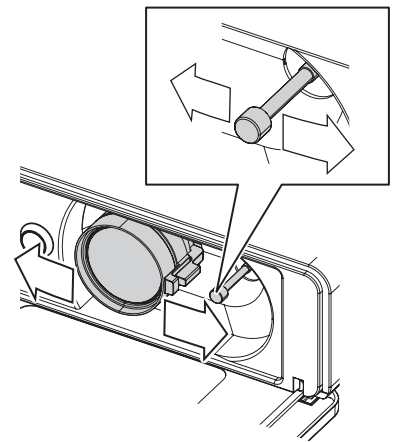

### ● Vertical shift

You can place the projector where the projector lens is up to 50% vertically off-centre from the screen and then adjust the image position with the **Lens shift lever**.

Up to about 50 % of the projection

Up to about 50 % of the projection

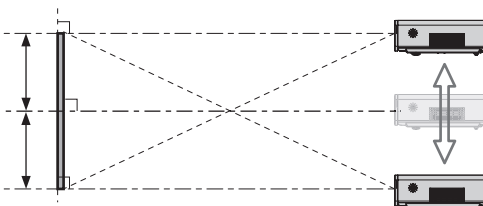

Shifting the lever down:  
Moving to screen's bottom.

Shifting the lever up:  
Moving to screen's top.

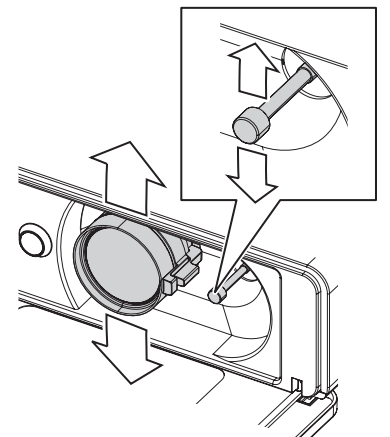

## Projector location range

You can determine where to locate the screen and the projector by considering the lens shift possibilities. See "Positioning the image" on page 24.

### When the screen position is fixed

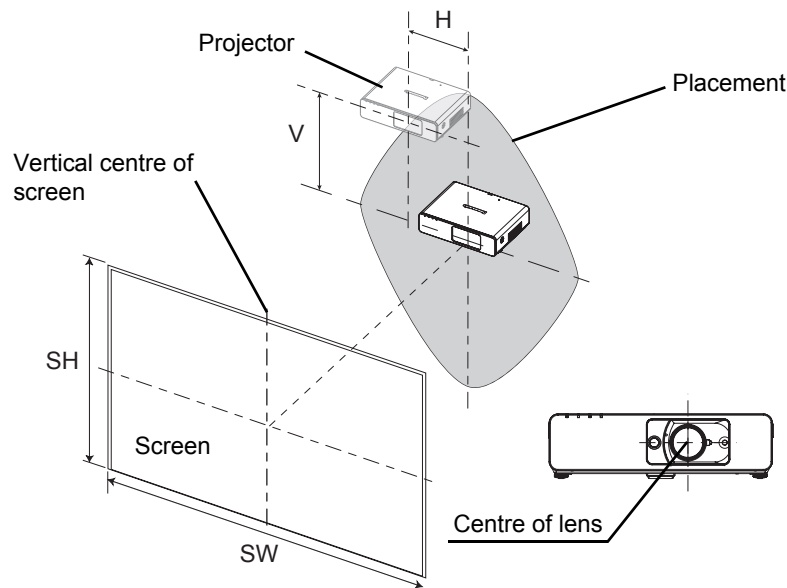

### When the projector position is fixed

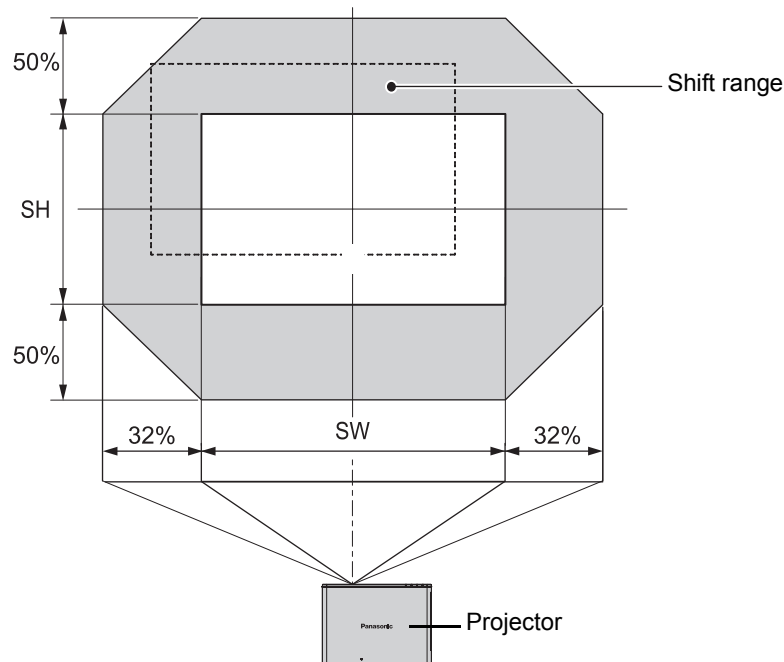

#### NOTE:

- When the projector is located right in front of the screen and the **Lens shift lever** is centred, you will get the best quality of the projection image.
- When the **Lens shift lever** is at the vertical limit of the shift range, you cannot move the lever to the horizontal limit, likewise when the **Lens shift lever** is at the horizontal limit of the shift range, you cannot move the lever to the horizontal limit.
- When the projector is tilted and you adjust **KEYSTONE**, the centre of the screen and the lens need to be realigned.
- Do not attempt to pull the **Lens shift lever** hard while adjusting.

# Connections

## Before connection to the projector

- Read and follow the operating and connecting instructions of each peripheral device.
- The peripheral devices must be turned off.
- Use cables that match each peripheral device to be connected.
- If the input signal is affected by signal jitter, the projected image may have poor image quality and timebase correction is effective.
- Confirm the type of video signals. See “List of compatible signals” on page 46.

## Connecting with computers

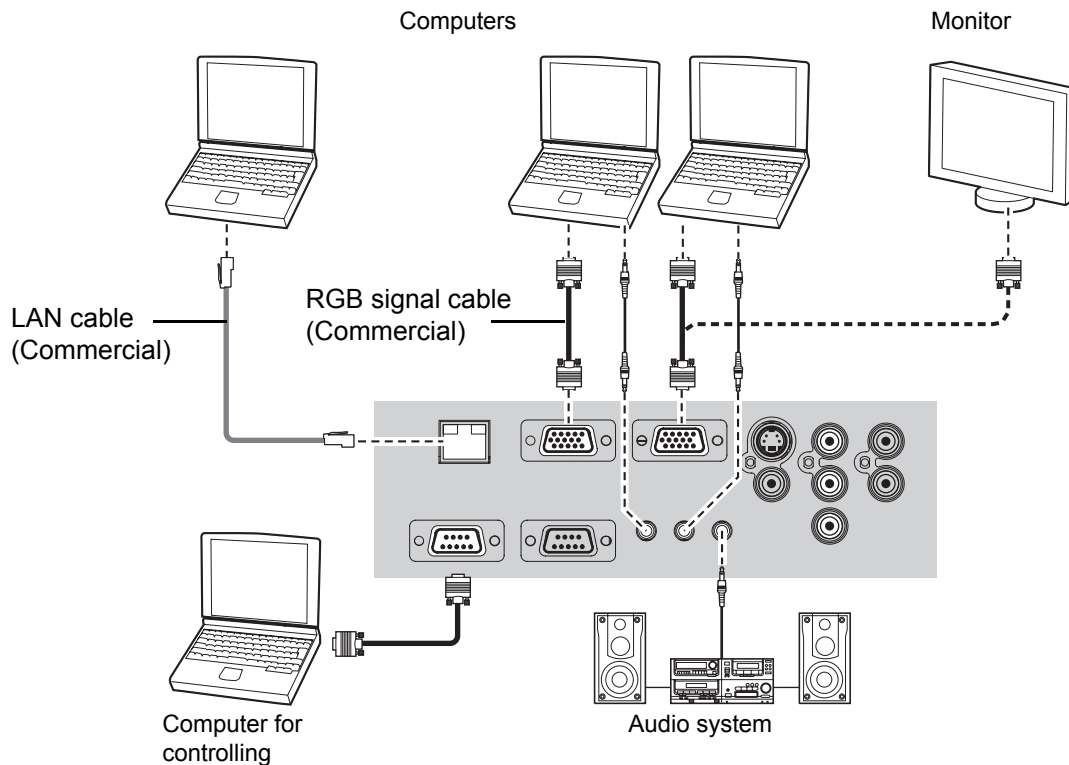

### NOTE:

- When **COMPUTER2 SELECT** in the **OPTION** menu is set to **OUTPUT**, do not connect any input signals.
- See **CD-ROM** contents for the LAN network connection.

### LAN terminal

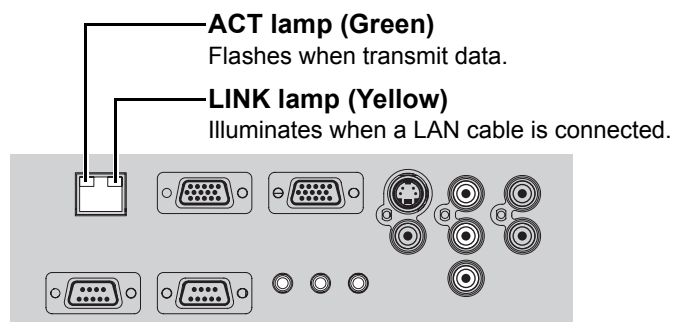

### NOTE:

- Do not touch the metal parts of the **LAN** terminal. Failure to observe this may cause malfunction by static electricity.

## Connecting with AV equipment

### Connecting with VIDEO IN/S-VIDEO IN

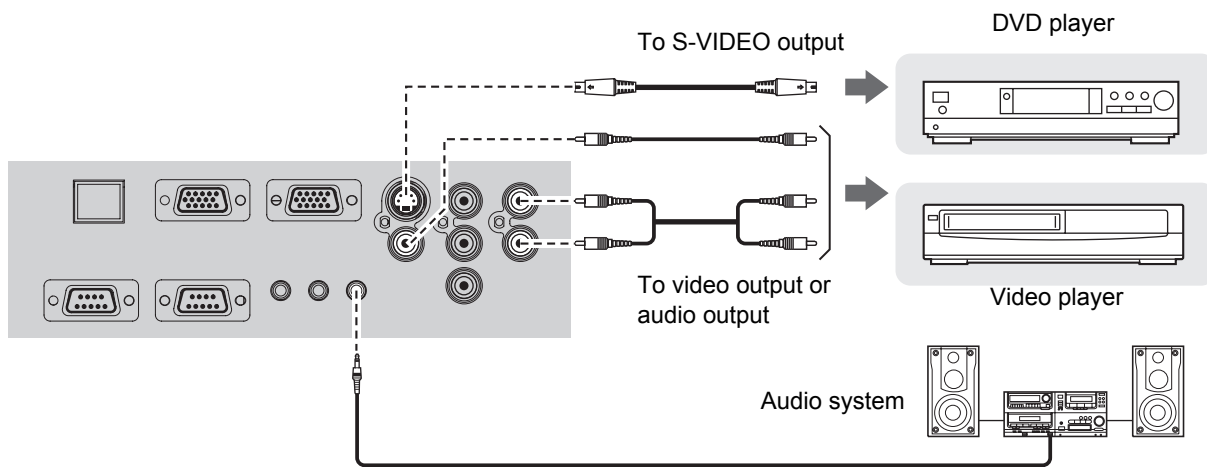

**NOTE:**

- When you connect more than one AV equipment, switch the audio connection manually.

### Connecting with COMPONENT IN

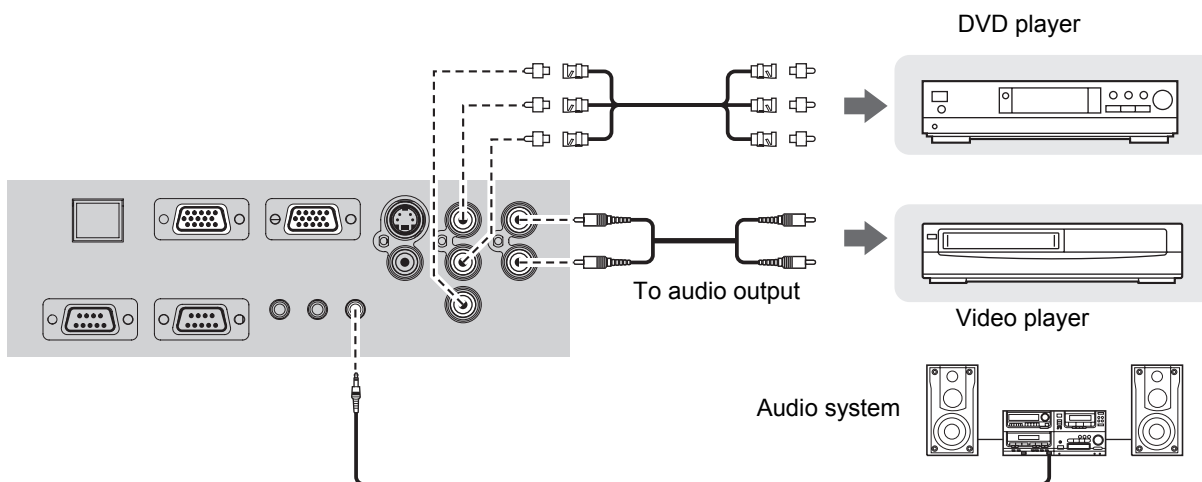

**NOTE:**

- If you connect the BNC cables, use with a commercial BNC-RCA adaptor.

# Switching the projector on/off

## Mains lead

### Connecting

1. Make sure the shape of the mains plug and the **AC IN** connector on the back of the projector match, then push the plug all the way in.
2. Connect the **Mains lead** to a mains socket.

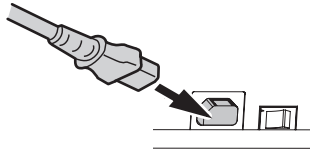

### Disconnecting

1. Make sure the **MAIN POWER** is switched off and unplug the **Mains lead** from the mains socket.
2. Hold the plug and unplug the **Mains lead** from the **AC IN** connector on the back of the projector.

### Direct power off function

You can disconnect the **Mains lead** from the projector or switch off the **MAIN POWER** button while projecting or soon after projecting. The internal lamp cooling fan will keep operating by the internal power supply.

#### NOTE:

- If the projector is switched on again while the internal cooling fan is still operating by the internal power supply, it may take a while to start the projection.

### Direct power on function

If you activate the **DIRECT POWER ON**, you can start the projection only with connecting the **Mains lead** or switching on the **MAIN POWER**. See "DIRECT POWER ON" on page 37.

#### NOTE:

- Do not use other than a provided **Mains lead**.
- Ensure all the input devices are connected and turned off before connecting the **Mains lead**.
- Do not force the connector as this may damage the projector and/or the mains lead.
- Dirt or dust build-up around plugs may cause fire or electrical hazards.
- Switch off the power to the projector when not in use.

## POWER indicator

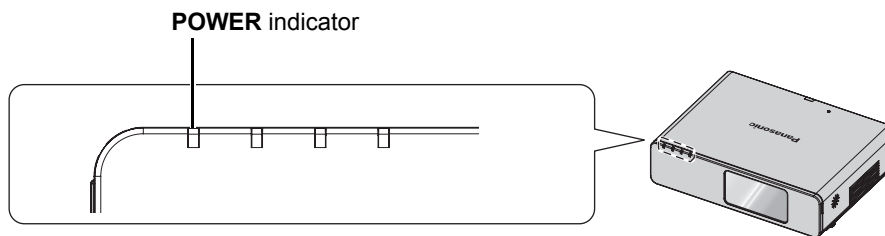

Indicator status		Status
No illumination or flashing		The <b>MAIN POWER</b> is switched off.
RED	Lit	The <b>MAIN POWER</b> is switched on and the projector is in standby. When the <b>LAMP</b> or <b>TEMP</b> indicator is flashing, the <b>POWER</b> indicator will not be lit.
	Flashing	Network connection is ready while the <b>POWER</b> is turned off.
GREEN	Flashing	The <b>POWER</b> is switched on and the projector is getting ready to project.
	Lit	The projector is ready to project.
ORANGE	Lit	The <b>POWER</b> is switched off and the projector is cooling the lamp.
	Flashing	The <b>POWER</b> is switched on again when cooling the lamp and recovering to projection mode. Recovery may take a while.

#### NOTE:

- If the projector is switched on again while the internal cooling fan is still operating by the internal power supply, it may take a while to start the projection.
- The electric consumption in standby mode is 3 W.

## Switching on the projector

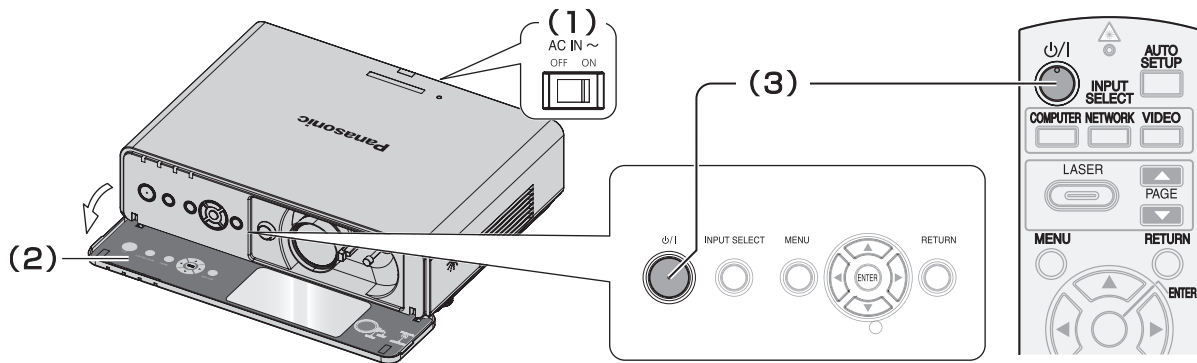

1. Switch the **MAIN POWER** on.
  - The power indicator lights up in **RED**.
2. Open the **Front panel cover**.
  - This is not necessary in **Remote control** operation.
3. Press the **POWER** button.
  - The power indicator lights up in **GREEN** after flashing for a while.
  - The **STARTUP LOGO** is displayed on the screen. See "STARTUP LOGO" on page 36.

### NOTE:

- Some small rattling or tinkling sound may be heard when starting up, but this is normal and does not affect the performance of the projector.
- If you disconnected the **Mains lead** or switched off the **MAIN POWER** while on projecting mode, the projection will start with connecting the **Mains lead** or switching on the **MAIN POWER**. See "DIRECT POWER ON" on page 37.

## Switching off the projector

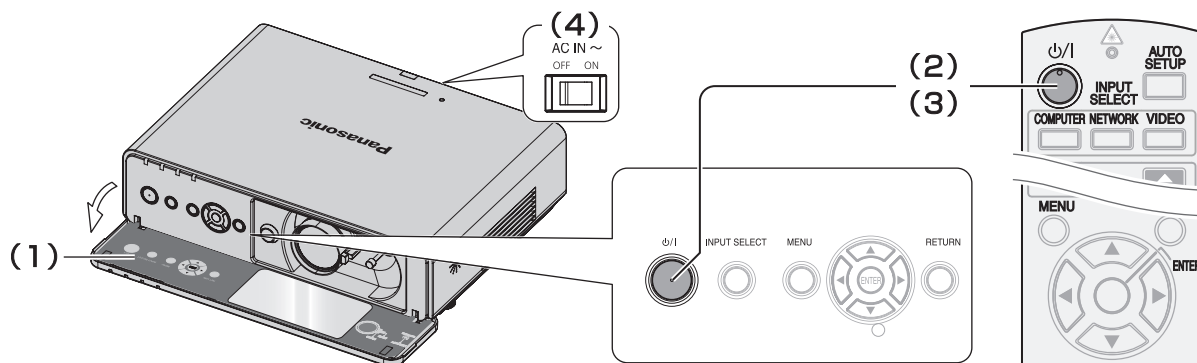

1. Open the **Front panel cover**.
  - This is not necessary in **Remote control** operation.
2. Press the **POWER** button.
  - The confirmation screen is displayed. It will disappear and return to the projection after 10 seconds without any operation.
  - To return to the projection, press any button except the **POWER** button.
3. Press the **POWER** button.
  - The power indicator lights up in **ORANGE** while cooling the lamp, then illuminates **RED** when is ready to switch off the **MAIN POWER**.
4. Switch off the **MAIN POWER** on the back of the projector.

### NOTE:

- Press the **POWER** twice or for a long duration to switch the power off.
- You can disconnect the **Mains lead** or switch off the **MAIN POWER** instead of following this procedure. See "DIRECT POWER ON" on page 37.
- You can turn off the projector by pressing the **POWER** button longer than 0.5 seconds.

# Projecting an image

## Selecting the input signal

1. Switch on the connected devices.
  - Press the play button of the required device.
2. Press the **INPUT SELECT** buttons to select the required input method if needed. See “Switching the input signal” on page 26.
  - The image will be projected on the screen.

### NOTE:

- **SIGNAL SEARCH** is **ON** as default and the signal from the connected devices is detected automatically. See “SIGNAL SEARCH” on page 37.

## Positioning the image

1. Open the **Front panel cover**.
2. Adjust the projected image with the **Lens shift lever**. See “Lens shift and positioning” on page 18.

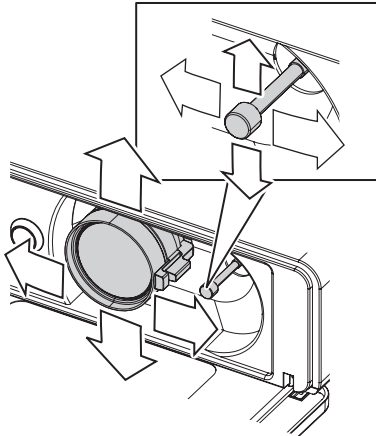

3. Adjust the angle of the projector.
  - Screw down the **Front leg adjusters** and adjust the angle vertically.
  - See “Front leg adjusters and throwing angle” on page 17.

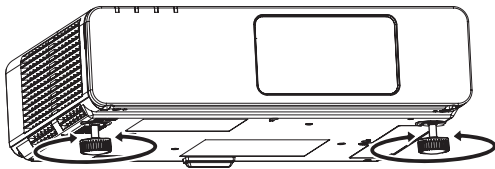

4. Adjust the focus and the projected image size.
  - Turn the **Focus lever** and **Zoom lever** to adjust the image.
  - You can confirm the adjusted effect with the **TEST PATTERN** in **OPTION** menu. See “TEST PATTERN” on page 38.

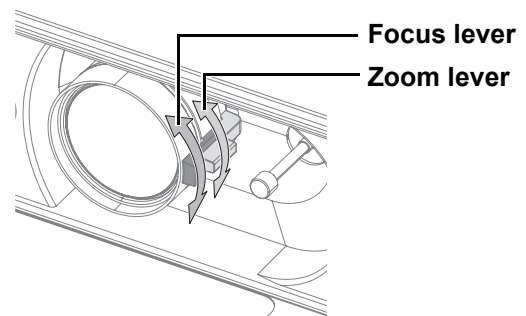

### NOTE:

- Do not touch the **Air Exhaust port** as this may cause burns or injury.
- If keystone distortion occurs, see “KEYSTONE” on page 34.
- If you adjust the focus, you may need to adjust the size of the image by moving the **Zoom lever** again.

# Remote control operation

## Operating range

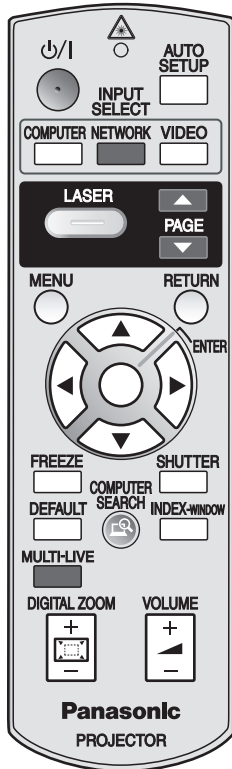

You can operate the projector with the **Remote control** within the remote range 15 m (49'2"), approximately  $\pm 30^\circ$  vertically and horizontally.

### ● Facing to the projector

Ensure the **Remote control emitter** is facing to the **Remote control signal receptor** on front/back of the projector and press the required buttons to operate.

### ● Facing to the screen

Ensure the **Remote control emitter** is facing to the screen and press the required buttons to operate the projector. The signal will be reflected off the screen. The operating range may differ due to the screen material. This function may not be effective with a translucent screen.

#### NOTE:

- Do not let strong light shine onto the signal receptor. The **Remote control** may malfunction under strong light such as fluorescent.
- If there are any obstacles between the **Remote control** and the **Remote control signal receptor**, the **Remote control** may not operate correctly.

## Setting up the image position automatically



You can adjust the setting of **POSITION**, **DOT CLOCK** and **CLOCK PHASE** in **POSITION** menu automatically for the projected **COMPUTER** signal image.

#### NOTE:

- If the dot clock frequency is 108 MHz or higher, **AUTO SETUP** is not effective.
- If the projected image is dark or blurred around the edge, **AUTO SETUP** may stop the processing before complete. Project a much clearer or lighter image and press the **AUTO SETUP** button again.

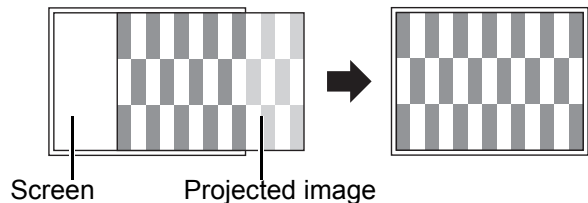

## Remote control operation

### Switching the input signal



You can switch the input method manually by pressing the **COMPUTER**, **NETWORK** (PT-F100NTE only) and **VIDEO** buttons. Press the required button several times or ◀ ▶ to cycle through the input methods as follows. The actual projected image will be changed in a while.

- The graphical guidance will be displayed on the upper right of the projected image and you can confirm the selected input method which is highlighted in yellow. See "INPUT GUIDE" on page 36.

#### Pressing the COMPUTER button



#### NOTE:

- Only when the **COMPUTER2 SELECT** is set to **INPUT**, you can switch between **COMPUTER1** and **COMPUTER2**.

#### Pressing the NETWORK button

- The **NETWORK** button is only for PT-F100NTE.
- See **CD-ROM** contents for more detailed information.

#### Pressing the VIDEO button

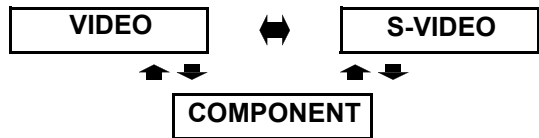

#### Pressing the INPUT SELECT button on the projector

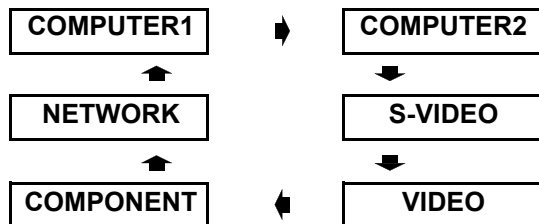

- NETWORK** is only for PT-F100NTE.

#### NOTE:

- If you select an unplugged input method, the guidance will blink on and off several times.
- See "List of compatible signals" on page 46.
- See "Connections" on page 20.

### Using the laser pointer



You can highlight items on the screen with the red laser pointer while projecting the image in presentations or visual demonstrations as an eye-catching pointing device.

Hold down the **LASER** button to go on the laser pointer and release to go off.

#### NOTE:

- The laser pointer should never be projected directly into the eyes of a person or animal.
- Do not aim the laser at reflective surfaces.
- Do not allow children to use laser pointer.
- Never look directly into the laser beam.
- The laser pointer is not effective with translucent screens.
- Please read the cautions on the **Remote control**.
- This is a Class 2 laser product.

#### Deactivating the LASER button

You can deactivate the **LASER** button for an accidental operation.

- Open the battery compartment cover of the **Remote control**.
  - Slide the switch tab.
  - Close the battery compartment cover of the **Remote control**.
- See "Battery compartment" on page 13.

#### Top view

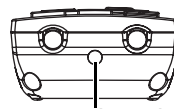

Laser pointer beam emitter

#### Deactivating switch

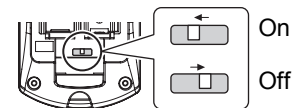

#### Cautions

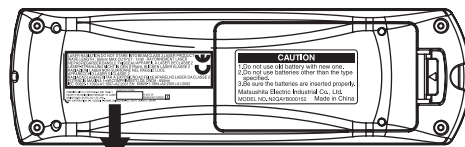

**LASER RADIATION DO NOT STARE INTO BEAM CLASS 2 LASER PRODUCT**  
 WAVE LENGTH : 650nm MAX OUTPUT : 1mW RAYONNEMENT LASER  
 NE PAS REGARDER DANS LE FAISCEAU APPAREIL A LASER DE CLASSE 2  
 LASER-STRAHLUNG NICHT IN DEN STRAHL BLICKEN LASER KLASSE 2  
 RADIAZIONI LASER NON GUARDARE NEL RAGGIO LUCE  
 APPARECCHIO LASER DI CLASSE 2  
 RADIAÇÃO LASER EVITAR A EXPOSIÇÃO AO FEIXE APARELHO LASER DA CLASSE 2  
 POTENCIA MÁXIMA 1mW COMPRIMENTO DE ONDA : 650nm  
 IEC 60825-1:1993+A1:1997+A2:2001 EN 60825-1:1994+A2:2001+A1:2002

COMPLIES WITH 21 CFR 1040.10 AND 1040.11 EXCEPT FOR REVIEWS PURSUANT TO LASER NOTICE NO.50, DATED JULY 26, 2001. MANUFACTURED BY PANASONIC CORPORATION S-C, 1005SH 4-HOME, SHINAGAWA-KU, TOKYO 148-8501, JAPAN



**CAUTION:** Use of controls or adjustments or performance of procedures other than those specified herein may result in hazardous radiation exposure.

## Capturing an image

**FREEZE**  
 When projecting an image, press **FREEZE** to capture the projected image and display it on the screen as a still picture. While the image is frozen, the sound will be stopped.

Press the **FREEZE** button to return to the projection.

## Stopping the projection temporary

**SHUTTER**  
 You can turn off the lamp and stop the projection temporary for electrical power save.

Press the **SHUTTER** button to return to the projection.

## Resetting to the factory default settings

**DEFAULT**  
 You can reset most of the customised settings to the factory defaults by pressing the **DEFAULT** button of the **Remote control**. Display the required sub menu or the menu items and press the **DEFAULT** button again.  
 ● See "Main menu and Sub-menu" on page 30.

**NOTE:**

- Some menu items are not available to reset by pressing the **DEFAULT** button. Adjust each menu items manually.
- To reset all the settings to the factory defaults, see "INITIALIZE ALL" on page 38.

## Projecting an image in INDEX-WINDOW mode

**INDEX-WINDOW**  
 You can project an image in split 2 windows as an **INDEX-WINDOW**, one is frozen, stored in memory and displayed on the screen's left side, while the display of subsequent images continues on the right. To escape from the **INDEX-WINDOW**, press the **MENU** or **RETURN** button.

● **Changing the image size**

Press **▲ ▼** to switch and cycle through in 3 size.

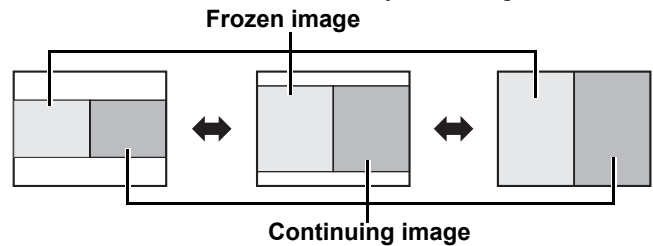

**NOTE:**

- If you change the window size, the aspect ratio of the image is changed and becomes vertically elongated.

● **Switching the position**

In default, the frozen image is displayed on the left and the subsequent image is displayed on the right. Press **◀ ▶** to switch the position.

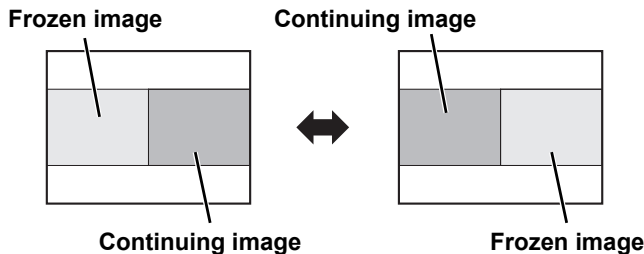

● **Capturing a new image**

While in **INDEX-WINDOW** mode, press **ENTER** to capture a new image and the frozen image window will be updated in a while.

## Remote control operation

### Enlarging the centred area

#### DIGITAL ZOOM



You can enlarge the projected image down to a centred area for emphasizing within the range of 1x to 2x.

#### ● Enlarging the image

1. Press **DIGITAL ZOOM +/-** once.
  - The centred area of the image will then be enlarged to 1.5x.

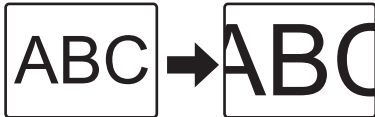

2. Adjust the image size by pressing **DIGITAL ZOOM +/-**.
  - The image size will be changed in steps of 0.1.



#### ● Shifting the centre point

Press **▲ ▼ ◀ ▶** to shift the centre point.

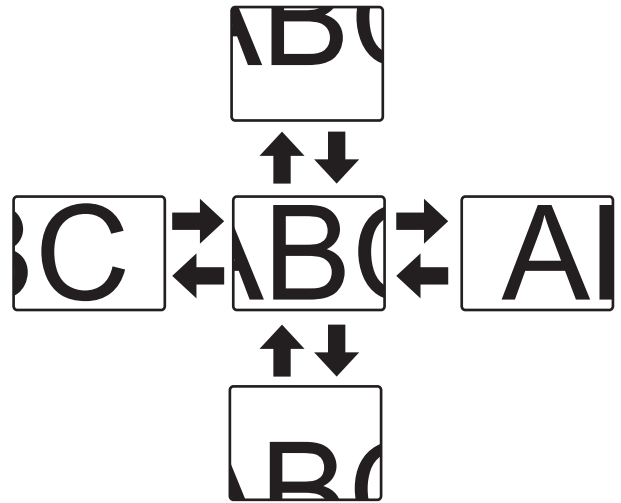

#### NOTE:

- When the **COMPUTER** signal is projected, the enlargement range will be changed to 1x to 3x. When the **FRAME LOCK** in **POSITION** menu is set to **ON**, the enlargement range is 1x to 2x. See "FRAME LOCK" on page 35.
- When the input signal is changed while the **DIGITAL ZOOM** is activated, the **DIGITAL ZOOM** will be cancelled.
- While the **DIGITAL ZOOM** is activated, **FREEZE** is not available.

### Controlling the volume of the speaker

#### VOLUME



You can control the volume of the built-in speakers and output sound. Press +/- to control the volume.

#### NOTE:

- Power consumption can be reduced if the volume level is lowered.

# Menu Navigation

The menu system allows you to access functions which do not have their own dedicated buttons on the **Remote control**. The menu options are structured and categorised. You can navigate through the menu with ▲ ▼ ► ◀ buttons.

## Navigating through the MENU

### Displaying the Main menu

**MENU** Press the **MENU** button to display the **Main menu** and the operating guidance.

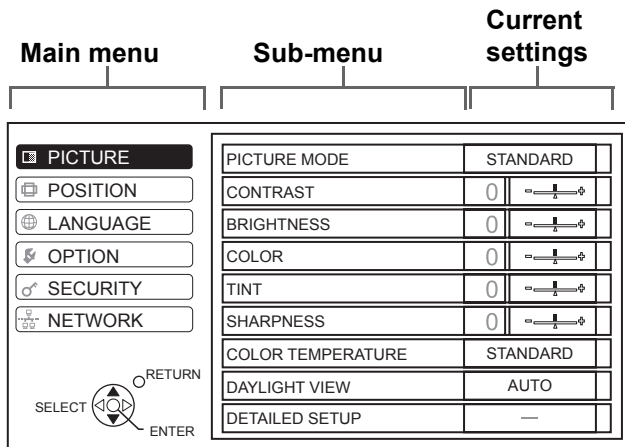

#### Operating guidance

Contains the required buttons to adjust the settings.

### Adjusting with the bar scale items

The triangle mark under the bar indicates factory default setting and the square indicates the current setting.

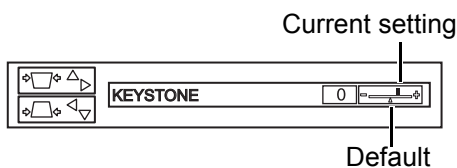

### Returning to the previous menu

**RETURN** Press the **MENU** or **RETURN** button to return to the previous menu. Press repeatedly to escape from the menu mode and return to the projection.

### Operating procedure

- Press ▲ ▼ to scroll to the required **Main menu** item and press **ENTER** to select.
  - The selected item is highlighted in orange and the **Sub-menu** is displayed on the right.
  - See “Main menu and Sub-menu” on page 30.

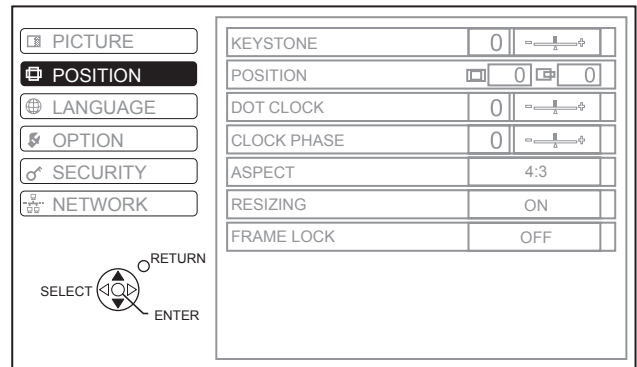

- Press ▲ ▼ to scroll to the required **Sub-menu** item and press ◀ ► or **ENTER** to adjust.
  - The selected item is called up and the other menu items disappear from the screen. Called up item will be disappear after 5 seconds and return to the menu mode.
  - If there is a lower level, the next level will be displayed.

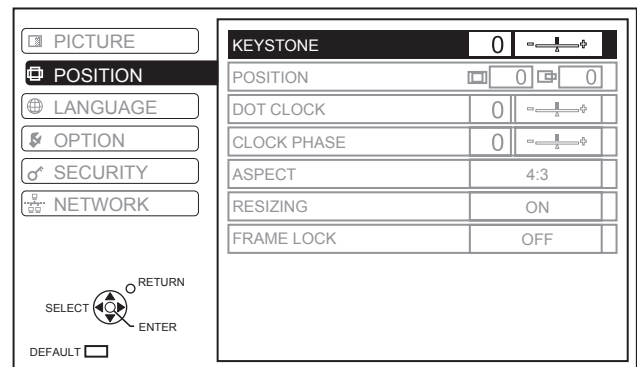

- Press ◀ ► to adjust or set the selected item.
  - For items using a bar scale, the current settings are displayed on the left of the bar scale.
  - You can cycle through the options of an item by pressing ◀ ►.



- Press **MENU** or **RETURN** to return to the previous menu.

#### NOTE:

- See “Resetting to the factory default settings” on page 27 to reset each menu items.
- See “INITIALIZE ALL” on page 38 to reset all the settings.





# Menu Navigation

## Main menu and Sub-menu

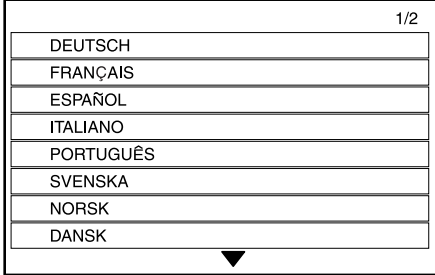

The **Main menu** has 6 options. Select the required menu item and press **ENTER** to display the **Sub-menu**.

**NOTE:**

- Some default settings vary by the selected input signal.
- **Sub-menu** items vary according to the selected input signal.
- Some settings are adjustable without any signals.

Main menu	Sub-menu	Options ( * is default setting)		Page	
<b>PICTURE</b> 	<b>PICTURE MODE</b>	<b>NATURAL</b>	<b>DYNAMIC</b> <sup>*1</sup>	page 32	
		<b>STANDARD</b> *	<b>BLACKBOARD</b>		
		<b>CONTRAST</b>	• Default: 0		page 32
		<b>BRIGHTNESS</b>	• Default: 0		page 32
		<b>COLOR</b> <sup>*2</sup>	• Default: 0		page 32
		<b>TINT</b> <sup>*2</sup>	• Default: 0		page 32
		<b>SHARPNESS</b>	• Default: 0		page 32
		<b>COLOR TEMPERATURE</b>	<b>LOW</b>	<b>STANDARD</b> *	page 32
			<b>HIGH</b>		
		<b>DAYLIGHT VIEW</b>	<b>AUTO</b> *	<b>ON</b>	page 32
	<b>DETAILED SETUP</b> <sup>*3</sup>	<b>WHITE BALANCE</b> <sup>*4</sup>	<b>WHITE BALANCE RED</b>	page 33	
		• Default: 0	<b>WHITE BALANCE GREEN</b>		
			<b>WHITE BALANCE BLUE</b>		
	<b>TV-SYSTEM</b> (S-VIDEO/VIDEO signals only)	<b>AUTO</b> *	<b>NTSC</b>		
			<b>NTSC 4.43</b>	<b>PAL</b>	
			<b>PAL-M</b>		
			<b>PAL-N</b>		
		<b>SECAM</b>			
		<b>STILL MODE</b> (S-VIDEO/VIDEO)	<b>OFF</b> *	<b>ON</b>	
			<b>ON</b>		
		<b>NOISE REDUCTION</b> (S-VIDEO/VIDEO)	<b>ON</b> *	<b>OFF</b>	
			<b>OFF</b>		
<b>POSITION</b> 	<b>KEYSTONE</b> <sup>*5</sup>	• Default: 0		page 34	
	<b>POSITION</b>	<b>H</b>	• Default: 0		page 34
		<b>V</b>	• Default: 0		
		<b>DOT CLOCK</b> <sup>*4</sup>	• Default: 0		page 34
		<b>CLOCK PHASE</b> <sup>*6</sup>	• Default: 0		page 34
		<b>ASPECT</b>	<b>4:3</b> *	<b>S4:3</b>	page 34
			<b>16:9</b>	<b>AUTO</b>	
	<b>RESIZING</b>	<b>OFF</b> *	<b>ON</b>	page 35	
	<b>FRAME LOCK</b> <sup>*2</sup>	<b>OFF</b> *	<b>ON</b>	page 35	
<b>LANGUAGE</b> 					

\*1. Default setting for **COMPUTER/NETWORK** signals  
 \*2. Not available with **COMPUTER/NETWORK** signals  
 \*3. **VIDEO/S-VIDEO/COMPUTER** signals only  
 \*4. **COMPUTER** signals only  
 \*5. Only **KEYSTONE** is available with **NETWORK** signals  
 \*6. **COMPUTER/COMPONENT** signals only

Main menu	Sub-menu	Options ( * is default setting)		Page	
	INPUT GUIDE	DETAILED* OFF	SIMPLE	page 36	
	STARTUP LOGO	ON* USER	OFF	page 36	
	COMPUTER2 SELECT	INPUT*	OUTPUT	page 36	
	FILTER SETUP	1 2	3	page 36	
	FILTER REMAINING			page 36	
	LAMP RUNTIME			page 37	
	POWER OFF TIMER	OFF* 15 MIN. 20 MIN. 25 MIN. 30 MIN. 35 MIN.	40 MIN. 45 MIN. 50 MIN. 55 MIN. 60 MIN.	page 37	
	DIRECT POWER ON	OFF*	ON	page 37	
	CONTROL PANEL	VALID*	INVALID	page 37	
	AUTO SETUP	AUTO*	BUTTON	page 37	
	SIGNAL SEARCH	ON*	OFF	page 37	
	INSTALLATION	FRONT/DESK* FRONT/CEILING	REAR/DESK REAR/CEILING	page 37	
	HIGHLAND	OFF*	ON	page 38	
	TEST PATTERN			page 38	
	DETAILED SETUP	OSD DESIGN	TYPE1 TYPE3	TYPE2	page 38
		SXGA MODE	SXGA	SXGA+	
		XGA MODE	XGA	WXGA	
		BLACKBOARD	ON*	OFF	
		BACK COLOR	BLUE*	BLACK	
		VOLUME			
AUDIO BALANCE		• Default: 0			
INITIALIZE ALL					
	INPUT PASSWORD	OFF*	ON	page 39	
	PASSWORD CHANGE			page 39	
	TEXT DISPLAY	OFF*	ON	page 39	
	TEXT CHANGE			page 39	
  (PT-F100NTE only. See CD-ROM contents)	WIRED LAN			page 40	
	WIRELESS LAN				
	NAME CHANGE				
	INPUT PASSWORD				
	PASSWORD CHANGE				
	NETWORK STANDBY				
	WEB CONTROL				
	LIVE MODE CUT IN				
	STATUS				
	INITIALIZE				

# PICTURE menu

**Remote control**

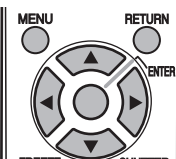

- See “Navigating through the MENU” on page 29.
- See “Main menu and Sub-menu” on page 30.

**Control panel**

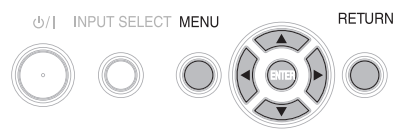

## PICTURE MODE

Depending on the projection environment, you can use these preset parameter settings to optimise image projection. Press ◀ ▶ to cycle through the options.

<b>NATURAL</b>	Reproduces the original colour of the image
<b>STANDARD</b>	Setting for a general image
<b>DYNAMIC</b>	Bright and sharp setting
<b>BLACKBOARD</b>	Setting for when projecting on a blackboard See “BLACKBOARD” on page 38.

**NOTE:**

- It may take for a while until the selected mode is stabilised.

## CONTRAST

You can adjust the contrast of the projected image. Adjust the **BRIGHTNESS** in advance if necessary.

Lower

Higher

## BRIGHTNESS

You can adjust the brightness of the projected image.

Darker

Brighter

## COLOR

You can adjust the colour saturation of the projected image. (Available with signals from **VIDEO/S-VIDEO/COMPONENT** only)

Lighter

Darker

## TINT

You can adjust the skin tone in the projected image. (Available with signals from **VIDEO/S-VIDEO/COMPONENT** only)

More reddish

More greenish

## SHARPNESS

You can adjust the sharpness of the projected image.

Less sharp

More sharp

## COLOR TEMPERATURE

You can adjust the white balance of the projected image.

- **LOW** More bluish
- **STANDARD** Balanced white
- **HIGH** More reddish

## DAYLIGHT VIEW

You can keep the projected image bright and vivid even in well-lit rooms where the ambient light sources cannot be controlled, such as when a door opens or when window coverings fail to block out sunlight.

- **AUTO:** Automatic adjustment
- **ON:** Active
- **OFF:** Deactive

**NOTE:**

- Do not cover the **ALS** (Ambient Luminance Sensor) of the projector. See “ALS (Ambient Luminance Sensor)” on page 14.
- **AUTO** is not available when **INSTALLATION** setting in **OPTION** menu is set to **REAR/DESK** or **REAR/CEILING**.

## DETAILED SETUP

You can perform more detailed image adjustment manually.

### For S-VIDEO/VIDEO signals

#### ● TV-SYSTEM

When the video signal is changed, the setting switches automatically. You can switch the setting manually to match the video data. Press ◀ ▶ to cycle through the options.

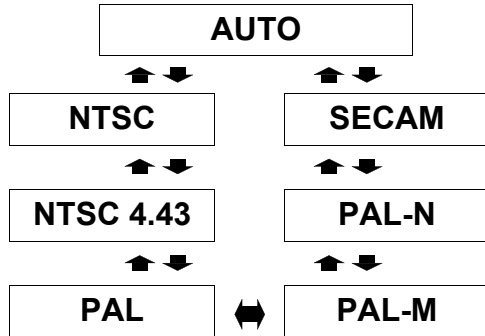

#### NOTE:

- AUTO setting will select from NTSC/NTSC 4.43/PAL/PAL60/PAL-M/PAL-N/SECAM.

#### ● STILL MODE

You can reduce the vertical flicker when projecting a still image.

- OFF: Deactive
- ON: Active

#### NOTE:

- Set to OFF when projecting a moving image.

#### ● NOISE REDUCTION

You can switch the automatic noise reduction system on/off. Press ◀ ▶ to select the required setting.

- ON: Automatic noise reduction
- OFF: No noise reduction

#### NOTE:

- Applying noise reduction may affect image quality.

### For RGB signals

#### ● WHITE BALANCE

You can adjust the white balance more properly in 3 colours temperature by pressing ◀ ▶.

- WHITE BALANCE RED
- WHITE BALANCE GREEN
- WHITE BALANCE BLUE

# POSITION menu

**Remote control**

- See "Navigating through the MENU" on page 29.
- See "Main menu and Sub-menu" on page 30.

**Control panel**

## KEYSTONE

If the projector is aligned non-perpendicularly to the screen, or if the projection screen has an angled surface, you can correct keystone.

Image	Operation

### NOTE:

- You can correct the distortion  $\pm 30$  degrees from the plane. For a better quality image, installing the projector with a minimum of distortion is recommended.
- Some distortion may be retained for lens shift adjustment.
- The distortion of the **Main menu** screen is not correctable.
- The result of the keystone correction will affect the aspect ratio and the size of the image.

## POSITION

You can move the projected image for fine adjustment. Press  $\blacktriangleleft \blacktriangleright$  to move horizontally and  $\blacktriangle \blacktriangledown$  vertically. (Available with signals from **VIDEO/S-VIDEO/COMPUTER/COMPONENT** only)



## DOT CLOCK

If you have interference patterns of the projected image, which is sometimes referred to as moire or noise, you can minimize it by pressing  $\blacktriangleleft \blacktriangleright$  to adjust the clock frequency. (Available with signals from **COMPUTER** only)

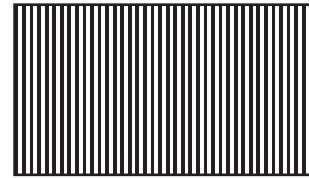

### NOTE:

- If the projecting signal's dot clock frequency is higher than 108 MHz, the adjustment may not make a difference.
- **DOT CLOCK** needs to be adjusted before adjusting the **CLOCK PHASE**.

## CLOCK PHASE

If you require further adjustment for the same reason as the **DOT CLOCK** adjustment, you can fine adjust the timing of the clock. Press  $\blacktriangleleft \blacktriangleright$  to adjust. (Available with signals from **COMPUTER/COMPONENT** only)

### NOTE:

- If the projecting signal's dot clock frequency is higher than 108 MHz, the adjustment may not make a difference.

## ASPECT

You can switch the aspect ratio manually when needed. Press  $\blacktriangleleft \blacktriangleright$  to cycle through the options.

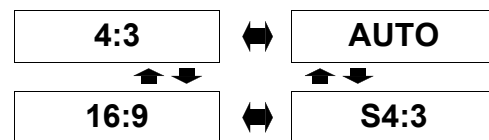

### ● 4:3

The input signal will be projected without any change.

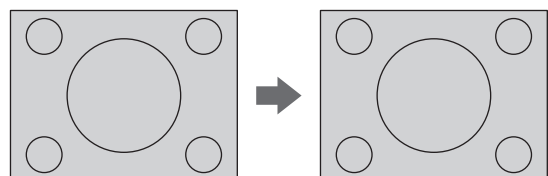

● **16:9**

The squeezed signal will be projected in 16:9 ratio.

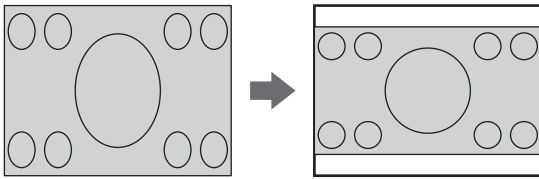

● **S4:3**

The input signal will be sized down 75 % and projected. **S4:3** mode is effective when projecting 4:3 image on to a 16:9 screen.

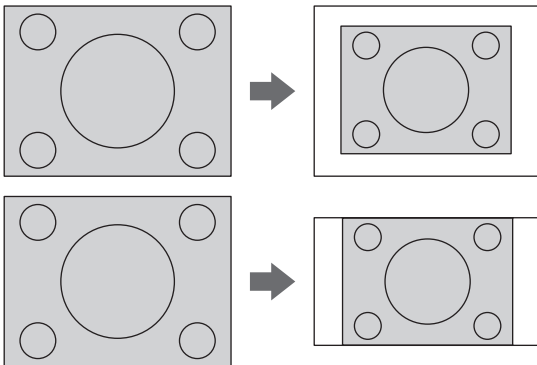

● **AUTO**

The S1 signal which contains an identifying signal will be detected and automatically project the image in proper ratio.

**NOTE:**

- If you project an image with an unmatched aspect ratio, the image may distort or some portions may be cropped. Select an aspect ratio which preserves the intention of the image creator.
- The order of **ASPECT** types is defined not only by the input method but also by the input signals. See “List of compatible signals” on page 46.
- If you project a copyrighted image enlarged or distorted by using **ASPECT** function in commercial use in a public place, such as a restaurant or hotel, you might infringe on the copyright of the creator which is protected by copyright law.

**RESIZING**

When the input signal resolution is lower than the projector resolution, it will be projected at the projector resolution. You can deactivate the **RESIZING** and project the lower resolution input signal at its original resolution. Press ◀ ▶ to select the required setting.

- **ON** Active
- **OFF** Deactive

**NOTE:**

- Usually the recommended setting is **ON**.
- When the **RESIZING** is set to **ON**, the lower resolution input signal may be projected in less quality.

**When the RESIZING is set to OFF;**

- The size of the image will be projected smaller and you may need to adjust **ZOOM** and **FOCUS**, or the projector position backwards and forwards.
- **DIGITAL ZOOM**, **KEystone** and **INDEX-WINDOW** are not available.

**FRAME LOCK**

If the projected image is degraded, you can activate **FRAME LOCK** for synchronisation. Press ◀ ▶ to select the required option.

- **OFF** Deactive
- **ON** Active

**NOTE:**

- This function is available with **COMPUTER** signals only.

# OPTION menu

**Remote control**

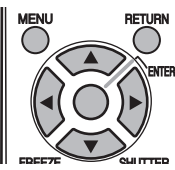

- See "Navigating through the MENU" on page 29.
- See "Main menu and Sub-menu" on page 30.

**Control panel**

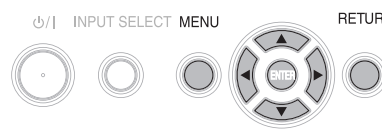

1. Select **USER** and press **ENTER**.
2. Select the required line to enter or edit the original text, and press **ENTER**.
3. Use **▲ ▼ ◀ ▶** to specify the location of the required character and press **ENTER**.
  - The selected character will be displayed in the box.
  - Select **DELETE** to delete the last entered character and press **ENTER**.
4. Repeat the step 3 until you finish the text to display in a line.
5. Select **OK** and press **ENTER** to set the entered text in a box.
  - Press **▼** and edit the **TEXT2** if you need to, and repeat the step 3 - 5.

## INPUT GUIDE

When you change the input method, the guidance appears in the upper right corner of the screen. The following display methods are available. Press **◀ ▶** to cycle through the options.

Options	Function
<b>OFF</b>	Turn off the guidance.
<b>SIMPLE</b>	Display the input method by text. The <b>INPUT GUIDE</b> will go out after 5 seconds without any operation.
<b>DETAILED</b>	Display the input method by graphic. The <b>INPUT GUIDE</b> will go out after 10 seconds without any operation. If you select any <b>COMPUTER</b> terminal which has no signal, the computer connection guidance will be displayed. See "Computer connection guidance" on page 48.

## COMPUTER2 SELECT

You can switch the function of the **COMPUTER2 IN/1 OUT** terminal.

- **INPUT**                      **COMPUTER2 IN**
- **OUTPUT**                    **COMPUTER1 OUT**

## FILTER SETUP

You can change the pace of the **ARF** (Auto Rolling Filter) performance for the use environment. Press **◀ ▶** to select the required option.

- **1**                              Ventilated with indoor air (e.g. small office room)
- **2**                              Ventilated with outdoor air (e.g. large office room, class room)
- **3**                              Public indoor space (e.g. restaurant, building lobby)

### NOTE:

- The **ARF** is a nonreusable product.
- Select the most suitable option for the use environment.
- If you select an unsuitable option, it may greatly affect on the duration of the projector life.

## FILTER REMAINING

You can check the remaining amount of the **ARF** (Auto Rolling Filter). The colour of the bar scale is indicating the condition of the **ARF**.

- Yellow                        The filter remaining amount is getting low.
- Red                            No more remaining.

### NOTE:

- See "Replacing the ARF (Auto Rolling Filter)" on page 42.
- After you replace the ARF, **FILTER REMAINING** should be reset to "0" by pressing the **ENTER** button for 3 seconds.

## STARTUP LOGO

You can switch the logo on/off that is displayed when starting up the projector. Press **◀ ▶** to select the required option. **STARTUP LOGO** will be displayed for 30 seconds.

- **ON**                              Active
- **OFF**                             Deactive
- **USER**                         Display the original text

### ● Editing the original text

If you select **USER**, you can display the 2 lines of original text up to 40 characters in 1 line instead of the logo.

TEXT CHANGE

A	B	C	D	E	F	G	H	I	J	K	L	M	DELETE		
N	O	P	Q	R	S	T	U	V	W	X	Y	Z			
a	b	c	d	e	f	g	h	i	j	k	l	m			
n	o	p	q	r	s	t	u	v	w	x	y	z			
0	1	2	3	4	5	6	7	8	9	SPACE					
!	"	#	\$	%	&	'	*	+	-	/	=	?@	\	^	
_	`		~	(	)	<	>	[	]	{	}	,	.	:	

OK
CANCEL

## LAMP RUNTIME

You can check how long the lamp has been used.

### NOTE:

- **LAMP RUNTIME** is a relevant matter for lamp replacement timing. See “Replacing the Lamp unit” on page 43.
- When the lamp unit is replaced with the new one (ET-LAF100), the setting will be reset to “0”.

## POWER OFF TIMER

You can set the off timer to switch off the **POWER** of the projector after a certain period of time automatically when no signal is detected. Press ◀ ▶ to select the required period from 15 to 60 minutes at intervals of 5 minutes.

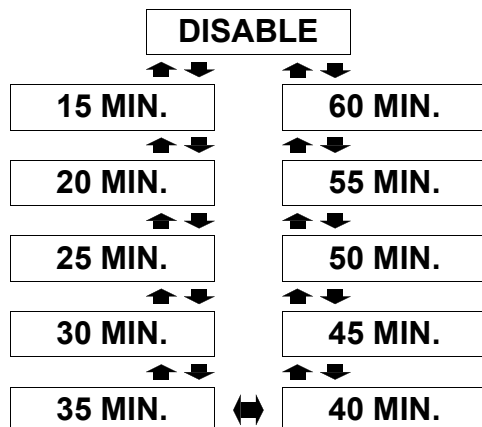

## DIRECT POWER ON

You can switch the projector start up status for when the **Mains lead** is connected while the **MAIN POWER** is on, or for when the **MAIN POWER** is switched on while the **Mains lead** is connected. Press ◀ ▶ to select the required option.

- **OFF** The projector will start from the standby mode or the projecting mode.
- **ON** The projector will start from the projecting mode.

### NOTE:

- When the projector is started from the projecting mode, pressing the **POWER** button procedure is skippable.

## CONTROL PANEL

You can turn off the function of the control panel buttons on the projector body. Press ◀ ▶ to select the required option.

- **INVALID** Invalidate the control panel buttons Confirmation screen will be displayed.
- **VALID** Validate the control panel buttons

## AUTO SETUP

You can turn off the **AUTO SETUP** function for when the **COMPUTER** signal is detected.

- **AUTO** When the projector detect a **COMPUTER** signal, adjust the projected image position automatically for **SIGNAL SEARCH**, **DOT CLOCK** and **CLOCK PHASE**.
- **BUTTON** Only when the **AUTO SETUP** button is pressed, the projected image position will be adjusted for **DOT CLOCK** and **CLOCK PHASE**. See “Remote control” on page 13.

### NOTE:

- Usually the recommended setting is **AUTO**.

## SIGNAL SEARCH

You can turn off the auto signal detecting system.

- **ON** Detect the input signal from the terminals and project the image.
- **OFF** Deactive

### NOTE:

- **SIGNAL SEARCH** is not available when any input signal is projecting.
- Usually the recommended setting is **ON**.

## INSTALLATION

When installing the projector, select the projection method according to the projector position. Press ◀ ▶ to cycle through the options. See “Projection method” on page 17.

<b>FRONT/DESK</b>	Setting on a desk/floor and projecting from front
<b>FRONT/CEILING</b>	Mounting in the ceiling and projecting from front
<b>REAR/DESK</b>	Setting on a desk/floor and projecting from rear
<b>REAR/CEILING</b>	Mounting in the ceiling and projecting from rear

## OPTION menu

### HIGHLAND

If you use the projector at high elevation, the **HIGHLAND** setting need to be **ON** to set the fan speed high. Press ◀ ▶ to select the required option.

- **OFF** The fan speed is low.
- **ON** The fan speed is high.

#### NOTE:

- At 1 400 m (4 593 ft) above sea level, the setting must be **ON**.
- The loudness of fan noise depends on the **HIGHLAND** setting.

### TEST PATTERN

You can use the 7 different test patterns to adjust the focus of the image. See “Lens shift and positioning” on page 18.

1. Press **ENTER** to display the test pattern 1.
2. Press ◀ ▶ to select the required test pattern.
3. Adjust the focus with the **Focus lever**.
4. Press **MENU** or **RETURN** to return to the previous menu, or press repeatedly to escape the menu mode.

#### NOTE:

- When the projector and/or the screen is tilted, adjust the focus at the centre of the image. The upper and lower edge might be out of focus.
- When the image is distorted in keystone, adjust the **KEYSTONE** in **POSITION** menu.

### DETAILED SETUP

You can perform more detailed setting in various items.

#### OSD DESIGN

You can change the background colour of the menu. Press ◀ ▶ to select the required option.

TYPE1	Semi transparent black
TYPE2	Solid blue
TYPE3	Semi transparent dark blue

#### SXGA MODE

You can switch the setting between **SXGA** and the larger setting, **SXGA+**. Press ◀ ▶ to select the required option.

#### XGA MODE

You can switch the setting between **XGA** and the wider setting, **WXGA**. Press ◀ ▶ to select the required option.

#### BLACKBOARD

You can exclude the **BLACKBOARD** in menu items of **PICTURE MODE** in **PICTURE** menu. Press ◀ ▶ to select the required option.

- **ON** Include the **BLACKBOARD** in menu items.
- **OFF** Exclude the **BLACKBOARD** in menu items.

#### BACK COLOR

You can choose a **BLUE** or **BLACK** screen for when the projector is idle. Press ◀ ▶ to select the required option.

#### VOLUME

You can adjust the volume of the built-in monaural speaker and **VARIABLE AUDIO OUT** terminal.

- ◀ Decrease
- ▶ Increase

#### AUDIO BALANCE

You can adjust to hear the sound played equally through both right and left external stereo speakers, or shift the balance so more sound plays through the left or right side.

- ◀ More sound plays through the left side
- ▶ More sound plays through the right side

#### INITIALIZE ALL

You can reset all of the customised settings to the factory defaults except **NETWORK**, **LAMP RUNTIME** and **FILTER REMAINING** menu settings.

You can reset all of the customised settings to the factory defaults except **LAMP RUNTIME** and **FILTER REMAINING** menu settings.

1. Press the **ENTER** button
2. Turn off the projector by pressing the **POWER** button.
3. Switch off the **MAIN POWER** button to reset the projector.
4. The minimum required setting screen will be displayed.
  - See “Minimum required setting screen” on page 12.

# SECURITY menu

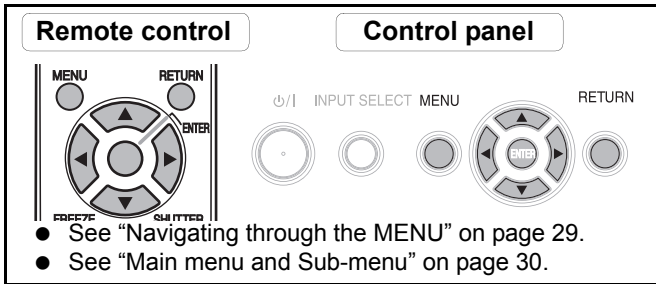

## Entering the SECURITY menu

Every time when you apply to the **SECURITY** menu, you will be asked to perform the password operation.

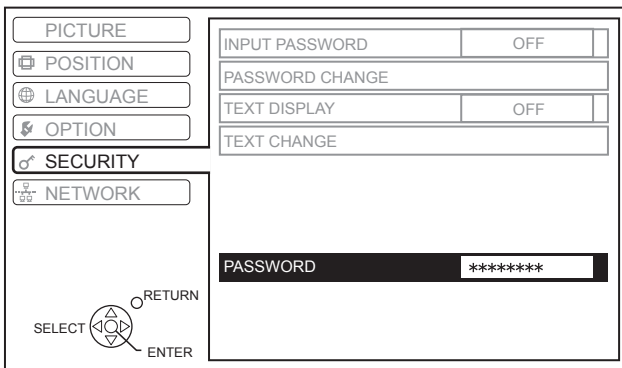

When you apply to the **SECURITY** menu before you change the password to your original, perform to input the following factory default password operation.

- Press ▲▶▼◀▲▶▼◀ and **ENTER**.

## After you change the password

When you apply to the **SECURITY** menu after you change the password to your original in the **PASSWORD CHANGE** menu, input the original password operation.

### NOTE:

- The factory default password is valid until you change the password in **PASSWORD CHANGE** menu.
- The entered password operations will appear as asterisks in the box.

## INPUT PASSWORD

You can activate the security system and the password operation will be asked to perform when the projecting mode started. Unless you perform the correct password operation, all of the button controls will be disabled except the **POWER** button.

- **OFF** Deactive
- **ON** Active

### NOTE:

- When you activated the security system, make sure to change the password to your original for safety.
- The factory default password is valid until you change the password in **PASSWORD CHANGE** menu.

## PASSWORD CHANGE

You can change the password operation to your original.

1. Press a series of button operation up to 8 as a password by using ▲ ▼ ◀ ▶ buttons.
2. Press **ENTER**.
3. Press the exact same series of button operation you entered in the **NEW** password box for confirmation.
  - If a series of button operation is incorrect, you will be asked to perform again.
4. Press **ENTER**.

### NOTE:

- The entered password operations will appear as asterisks in the box.

## TEXT DISPLAY

You can set your original text, such as company name or URL information, to display regularly at the bottom of the projected image while projecting.

- **OFF** Deactive
- **ON** Active

## TEXT CHANGE

You can enter your original text up to 22 characters for **TEXT DISPLAY**.

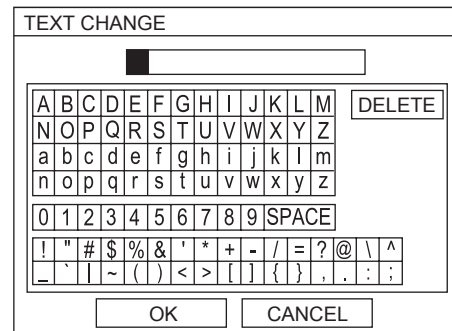

1. Use ▲ ▼ ◀ ▶ to specify the location of the required character.
2. Press **ENTER**.
  - The selected character will be displayed in the **TEXT CHANGE** box.
3. Repeat until finish your original text.
  - Select **DELETE** to delete the last entered character and press **ENTER**.
4. Select **OK** and press **ENTER** to set the entered text.
  - Select **CANCEL** or press **MENU/RETURN** buttons to return to the previous menu.

# NETWORK menu

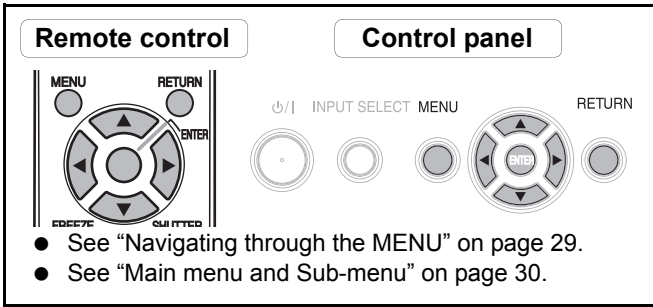

## NOTE:

- The **NETWORK** menu is available only with PT-F100NTE.
- See more detailed instructions in the contents of the **CD-ROM** which is provided with the projector.

## Items in NETWORK menu

In **NETWORK** menu, the following items are available.

- **WIRED LAN**
- **WIRELESS LAN**
- **NAME CHANGE**
- **INPUT PASSWORD**
- **PASSWORD CHANGE**
- **NETWORK STANDBY**
- **WEB CONTROL**
- **LIVE MODE CUT IN**
- **STATUS**
- **INITIALIZE**

# TEMP, LAMP and FILTER Indicators

## Managing the indicated problems

If a problem should occur with the projector, the **TEMP**, **LAMP** and/or **FILTER** indicators will inform you. Manage the indicated problems as follow.

1. Confirm the status of all indicators and projector, and switch off the projector in proper way.
2. Find out the cause of the problem by status of the **TEMP**, **LAMP** and/or **FILTER** indicators.
3. Follow the instruction for each indication below and solve the problem.
4. Turn on the projector in the correct way and confirm the indicator is not indicating a problem any longer.

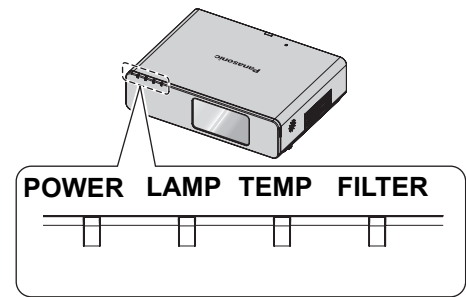

### NOTE:

- If no problem is found or the problem remains, do not turn on the projector. Instead contact an Authorised Service Centre.

### LAMP indicator

Indicator	● Illuminating <b>RED</b>	● Flashing <b>RED</b>		
Problem	<b>LAMP RUNTIME</b> has reached 2 800 hours.	<b>LAMP</b> circuit failure, abnormal function or <b>Lamp unit</b> is damaged.		
Cause	<b>Lamp unit</b> will run out soon and needs to be replaced.	The <b>MAIN POWER</b> is switched on again before the <b>Lamp unit</b> is cooled enough.	<b>LAMP</b> circuit failure, abnormal function.	<b>Lamp unit</b> is damaged.
Remedy	See “Replacing the Lamp unit” on page 43.	Let the <b>Lamp unit</b> cool down and turn on the <b>MAIN POWER</b> .	Contact an Authorised Service Centre.	See “Replacing the Lamp unit” on page 43.

### TEMP indicator

Indicator	● Illuminating <b>RED</b> and still projecting ● Flashing <b>RED</b> and <b>POWER</b> is turned off			
Problem	The temperature inside and/or outside the projector is abnormally high.			
Cause	The ventilation openings are covered.	The room temperature is too high.	The <b>ARF</b> is excessively dirty and the ventilation is poor.	The projector is located at high elevations (above 1 400 m).
Remedy	Remove the object(s) from the ventilation openings or clear around the projector.	Reinstall the projector in temperature controlled place. See page 50.	Replace the <b>ARF</b> in the proper method. See page 42.	Turn on the projector* <sup>1</sup> and set the <b>HIGHLAND</b> to <b>ON</b> . See page 38.

\*1. The projector will perform only 2 minutes with OFF setting at high elevation.

### FILTER indicator

When the **FILTER** indicator is flashing **GREEN**, the **ARF** is normally rolling up.

Indicator	● Illuminating <b>RED</b>	● Flashing <b>RED</b>	● Illuminating <b>ORANGE</b>	● Flashing <b>ORANGE</b>
Problem	<b>FILTER REMAINING</b> has turned red. See page 36.	The projector cannot detect the <b>ARF</b> .	The <b>ARF</b> cannot operate properly.	<b>FILTER REMAINING</b> has turned yellow. See page 36.
Cause	<b>ARF</b> has been run out.	<b>ARF</b> is not attached.	Foreign object is blocking the <b>ARF</b> operation.	<b>ARF</b> is running out.
Remedy	See “Replacing the ARF (Auto Rolling Filter)” on page 42.	Attach the <b>ARF</b> .	Remove the foreign object or contact an Authorised Service Centre.	Prepare the <b>ARF</b> for replacement.

# Care and Replacement

## Cleaning the projector

### Before cleaning the projector

- Switch off the **MAIN POWER** and disconnect the mains plug from the mains socket.
- Unplug all the cables from the projector.

### Cleaning the outer surface of the projector

Wipe off dirt and dust gently with a soft cloth.

- If it is difficult to remove the dirt, soak a cloth in a neutral detergent diluted with water, wring the cloth well and then wipe the projector. Dry off the projector with dry cloth.
- If you use a chemical treated wipe, follow the instructions supplied with it.

### Cleaning the lens and front glass surface

Wipe off dirt and dust gently with a lint-free cloth.

- Make sure no dirt or dust remains on the surface of the lens. It will be enlarged and projected onto a screen.

## Replacing the ARF (Auto Rolling Filter)

### Before replacing the ARF

- Press the **POWER** button for at least 0.5 seconds or press twice to turn off the projector.
- Wait until the cooling fan stops and the **POWER** indicator turn to **RED**.
- Disconnect the **Mains lead** from the main socket.
- Prepare a Phillips-head screw driver.
- Contact an Authorised Service Centre to purchase a replacement **ARF** (ET-RFF100).

### When to replace the ARF

**ARF** is consumable product and effects on ventilation. **FILTER** indicator will inform you of the replacement timing. You can check the remaining amount of the **ARF** in **FILTER REMAINING** menu.

#### NOTE:

- See "FILTER REMAINING" on page 36.
- See "FILTER indicator" on page 41.

### Replacement procedure

1. Turn the projector upside down and place it gently on a soft cloth.
2. Use a Phillips-head screwdriver to loosen 3 **ARF cover** fixing screws until the screws turn freely and remove the **ARF cover**.
3. Use a Phillips-head screwdriver to loosen an **ARF** fixing screws and release the clamp, then slightly slide up the used **ARF** to remove.
4. Insert the new **ARF** into the compartment in correct direction and slightly push down until it clicks. Tighten the **ARF** fixing screws securely with a Phillips-head screwdriver.
5. Attach the **ARF cover** and tighten the **ARF cover** fixing screws securely with a Phillips-head screwdriver.

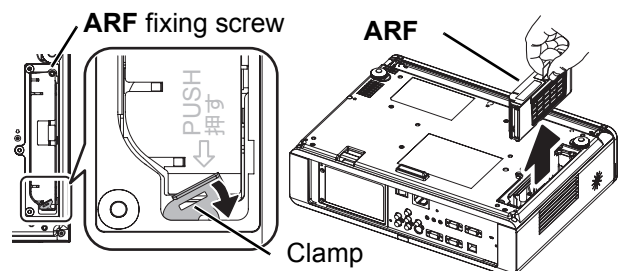
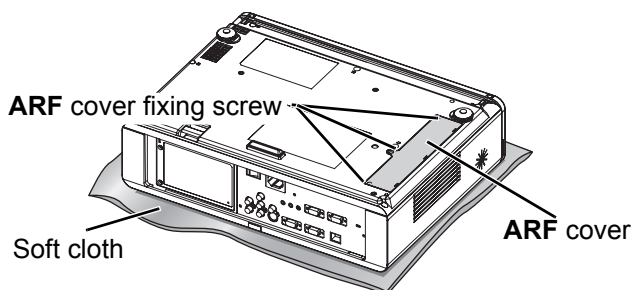

#### NOTE:

- If the **ARF** and/or **ARF cover** are attached incorrectly, the projector may not be turned on.
- Do not switch the power on while the **ARF cover** removed.
- When you replace the **ARF** unit, clean the compartment and/or the **Air Exhaust port** if you need to.

## Resetting the FILTER REMAINING

1. Turn on the projector and display the **FILTER REMAINING** in **OPTION** menu. Press the **ENTER** button for 3 seconds and the confirmation screen will be displayed.
2. Press **◀** to select **OK** and press the **ENTER** button to reset **FILTER REMAINING** to "0". See "FILTER REMAINING" on page 36.

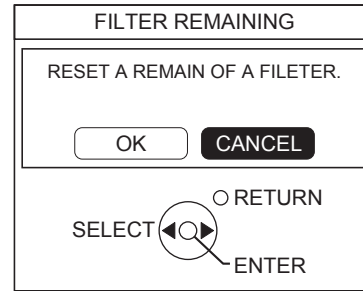

## Replacing the Lamp unit

### Before replacing the Lamp unit

- Switch off the **MAIN POWER** and disconnect the mains plug from the mains socket.
- Make sure the **Lamp unit** and the surroundings are cooled enough.
- Prepare a Phillips-head screwdriver.
- Contact an Authorised Service Centre to purchase a replacement **Lamp unit** (ET-LAF100).
- When the projector is mounted in the ceiling, do not work directly under the projector or put your face closer to the projector.

#### NOTE:

- Prior to replacing the lamp unit, allow it to cool down to prevent the risk of burns, damage and other hazards.
- Do not attempt replacement with an unauthorised lamp unit.

### When to replace the Lamp unit

The **Lamp unit** is consumable and the brightness decreases by duration of usage. The **LAMP** indicator will inform you of the replacement timing at 2 800 hours, and at 3 000 hours, the projector will be turned off. Those figures are rough guidance and might be shortened by the usage conditions, characteristics of the **Lamp unit**, environmental conditions, and so on. You can check the duration of usage time using **LAMP RUNTIME** in the **OPTION** menu.

Indication	On screen	LAMP indicator
Over 2 800 hours	"REPLACE LAMP" is displayed on the upper left of the screen for 30 seconds.	Illuminates <b>RED</b> .
Over 3 000 hours	"REPLACE LAMP" is displayed on the upper left of the screen, and it will stay until you respond. To clear the screen, press any button.	

#### NOTE:

- The guide times, 2 800 and 3 000 hours, are rough estimates based on certain conditions and is not a guaranteed time.
- For more information about the **Lamp unit**, such as guaranteed time, see the instructions which is provided with the **Lamp unit**.

## Care and Replacement

### Replacement procedure

#### Removing and replacing the lamp unit

1. Use a Phillips-head screwdriver to loosen the 2 **Lamp unit cover** fixing screws on the back of the projector until the screws turn freely, and remove the **Lamp unit cover**.

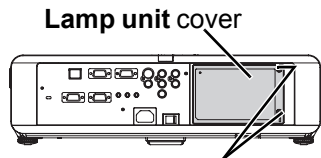

Lamp unit cover fixing screws

2. Use a Phillips-head screwdriver to loosen the 2 **Lamp unit** fixing screws.
3. Hold the handles of the **Lamp unit** and release the lamp unit lock.
4. Pull the used **Lamp unit** gently from the projector.

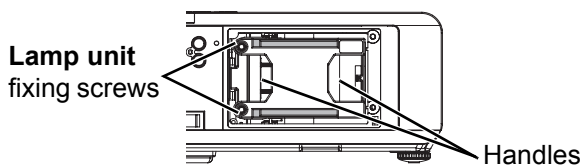

5. Replace the new **Lamp unit** in correct direction.

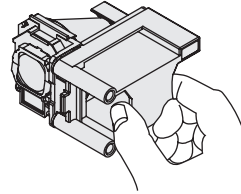

6. Press in the **Lamp unit** until it clicks and make sure the unit is installed securely.
7. Tighten the 2 **Lamp unit** fixing screws securely with a Phillips-head screwdriver.

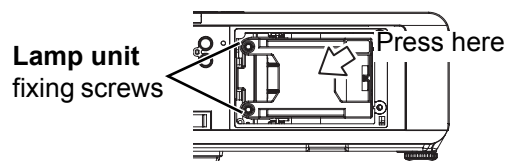

8. Attach the **Lamp unit cover** and tighten the 2 **Lamp unit cover** fixing screws securely with a Phillips-head screwdriver.
  - **LAMP RUNTIME** will be reset to "0" automatically.

## Ceiling mount bracket safeguards

The projector and the ceiling mount bracket are designed sufficiently safety though, make sure the safety cable provided with the projector is installed and attached to the bottom of the projector when mounting in the ceiling for safety and security.

### NOTE:

- Even if it is guarantee period, the manufacturer is not responsible for any hazard or damage caused by using a ceiling mount bracket which is not purchased from an authorised distributors, or environmental conditions.
- Make sure to use a torque driver and do not use an electrical screwdriver or an impact screwdriver.
- Installation work of the ceiling mount bracket should only be carried by a qualified technician.
- Remove an unused ceiling mount bracket promptly.

### Installing the safety cable

1. Install the ceiling mount bracket according to the installation instructions.
2. Loop the security cable around the ceiling mount bracket with less slack.
  - Lace the cable of the end with a latch through the loop on the other end of the cable.
3. Attach the latch on to the bottom of the projector with a provided screw.
  - Torque:  $1.25 \pm 0.2$  N·m

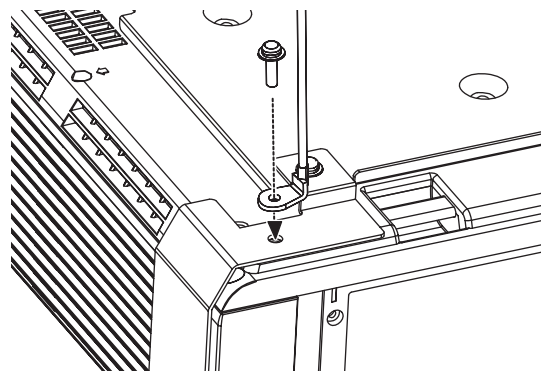
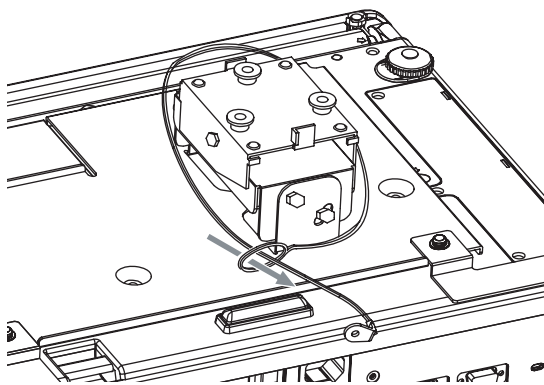

\* Indicated above is ET-PKF100S.

# Troubleshooting

Should any problem persist, contact your dealer.

Problem	Cause	Reference page
<b>Power does not turn on.</b>	● The mains lead may not be connected.	22
	● The <b>MAIN POWER</b> switch is turned off.	23
	● No electric supply is at the mains socket.	22
	● <b>TEMP</b> indicator is lit or flashes.	41
	● <b>LAMP</b> indicator is lit or flashes.	41
	● The lamp unit cover has not been securely installed.	44
	● The circuit breakers have tripped.	-
<b>No picture appears.</b>	● The video signal input source may not be connected to a terminal properly.	21
	● The input selection setting may not be correct.	26
	● The <b>BRIGHTNESS</b> adjustment setting may be at the minimum setting.	32
	● The signal input source may not be operating properly.	-
	● The <b>SHUTTER</b> function may be in use.	27
	● The <b>ARF</b> is removed or installed incorrectly.	42
<b>The picture is fuzzy.</b>	● The lens focus may not have been set correctly.	24
	● The projector may not be at the correct distance from the screen.	16
	● The lens may be dirty.	11
	● The projector may be tilted too much.	18
<b>The colour is pale or greyish.</b>	● <b>COLOR</b> or <b>TINT</b> adjustment may be incorrect.	32
	● The input source which is connected to the projector may not be adjusted correctly.	30
<b>No sound can be heard from the internal speaker.</b>	● The audio signal source may not be connected properly.	20
	● A cable may be connected to the <b>VARIABLE AUDIO OUT</b> terminal.	15
	● The volume adjustment may be at the lowest possible setting.	28
<b>The control buttons of the projector do not operate.</b>	● <b>CONTROL PANEL</b> in <b>OPTION</b> menu is invalidated. If you have a loss of the <b>Remote control</b> while the <b>CONTROL PANEL</b> is invalidated, press and hold the <b>MENU</b> button for 2 seconds with pressing the <b>ENTER</b> button.	37
<b>The Remote control does not operate.</b>	● The batteries may be weak.	-
	● The batteries may not have been inserted correctly.	13
	● The remote control signal receptor on the projector may be obstructed.	25
	● The remote control unit may be out of the operation range.	25
	● The <b>Remote control</b> is under the strong light such as fluorescent.	25
	● The <b>LASER</b> button is deactivated.	26
<b>The picture does not display correctly.</b>	● The signal format ( <b>TV-SYSTEM</b> ) may not have been set correctly.	33
	● There may be a problem with the VCR or other signal source.	-
	● A signal which is not compatible with the projector is being input.	46
<b>Picture from a computer does not appear.</b>	● The cable may be longer than the optional cable.	-
	● The external video output from a laptop computer may not be correct. (You may be able to change the external output settings by pressing the [Fn] + [F3] or [Fn] + [F10] keys simultaneously. The actual method varies depending on the type of computer; refer to the documentation provided with your computer for further details.)	48
	● <b>COMPUTER2 SELECT</b> setting in <b>OPTION</b> menu is not correct.	36

# Technical Information

## List of compatible signals

Mode	Display resolution (dots) <sup>*1</sup>	Scanning frequency		Dot clock frequency (MHz)	Picture quality <sup>*2</sup>	Terminals
		H (kHz)	V (Hz)			
NTSC/NTSC 4.43/ PAL-M/PAL60	720 x 480i	15.7	59.9		A	VIDEO/S-VIDEO
PAL/PAL-N/SECAM	720 x 576i	15.6	50.0		A	
480i	720 x 480i	15.7	59.9	13.5	A	COMPONENT/ COMPUTER <sup>*3</sup>
576i	720 x 576i	15.6	50.0	13.5	A	
480p	720 x 483	31.5	59.9	27.0	A	
576p	720 x 576	31.3	50.0	27.0	A	
1 080/60i	1 920 x 1 080i	33.8	60.0	74.3	A	
1 080/50i	1 920 x 1 080i	28.1	50.0	74.3	A	
720/60p	1 280 x 720	45.0	60.0	74.3	A	
720/50p	1 280 x 720	37.5	50.0	74.3	A	
VESA	640 x 400	31.5	70.1	25.2	A	
	640 x 400	37.9	85.1	31.5	A	
VGA480	640 x 480	31.5	59.9	25.2	A	COMPUTER
	640 x 480	35.0	66.7	30.2	A	
	640 x 480	37.9	72.8	31.5	A	
	640 x 480	37.5	75.0	31.5	A	
	640 x 480	43.3	85.0	36.0	A	
SVGA	800 x 600	35.2	56.3	36.0	A	
	800 x 600	37.9	60.3	40.0	A	
	800 x 600	48.1	72.2	50.0	A	
	800 x 600	46.9	75.0	49.5	A	
	800 x 600	53.7	85.1	56.3	A	
MAC	832 x 624	49.7	74.6	57.3	A	
	1 152 x 870	68.7	75.1	100.0	A	
XGA	1 024 x 768	48.4	60.0	65.0	AA	
	1 024 x 768	56.5	70.1	75.0	AA	
	1 024 x 768	60.0	75.0	78.8	AA	
	1 024 x 768	68.7	85.0	94.5	AA	
MXGA	1 152 x 864	64.0	71.2	94.2	A	
	1 152 x 864	67.5	74.9	108.0	A	
	1 152 x 864	76.7	85.0	121.5	B	
MSXGA	1 280 x 960	60.0	60.0	108.0	A	
SXGA	1 280 x 1 024	64.0	60.0	108.0	A	
	1 280 x 1 024	80.0	75.0	135.0	B	
	1 280 x 1 024	91.1	85.0	157.5	B	
SXGA60+	1 400 x 1 050	64.0	60.0	108	A	
	1 400 x 1 050	65.1	59.9	122.4	B	
UXGA	1 600 x 1 200	75.0	60.0	162.0	B	
WXGA	1 280 x 768	47.8	59.9	79.5	A	
	1 280 x 800	49.1	60.2	69.1	A	
	1 280 x 800	49.7	59.8	83.5	A	
WXGA+	1 440 x 900	55.9	59.9	106.5	A	

\*1. The "i" appearing after the resolution indicates an interlaced signal.

\*2. The following symbols are used to indicate picture quality.

AA Maximum picture quality can be obtained.

A Signals are converted by the image processing circuit before picture is projected.

B Some loss of data occurs to make projection easier.

\*3. YPbPr signals are available with COMPONENT terminal, and RGBHV signals are available with COMPUTER terminal.

## Serial terminal

The serial connector which is on the connector panel of the projector conforms to the RS-232C interface specification, so that the projector can be controlled by a personal computer which is connected to this connector.

### Connection

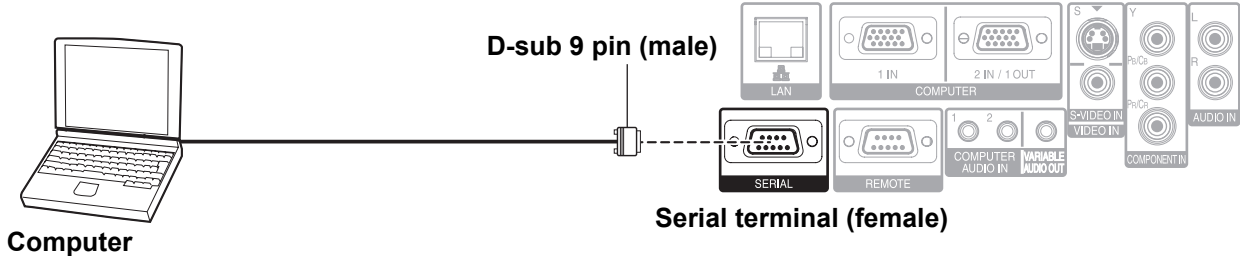

### Pin assignments and signal names

	Pin No.	Signal name	Contents
	①		NC
	②	TXD	Transmitted data
	③	RXD	Received data
	④		NC
	⑤	GND	Earth
	⑥		NC
	⑦	RTS	Connected internally
	⑧	CTS	
	⑨		NC

### Communication settings

Signal level	RS-232C	Character length	8 bits
Sync. method	Asynchronous	Stop bit	1 bit
Baud rate	9 600 bps	X parameter	None
Parity	None	S parameter	None

### Basic format

STX	Command	:	Parameter	ETX
Start byte (02h)	3 bytes	1 byte	1 byte - 4 bytes	End (03h)

The data streaming from the computer will start with STX, and proceed to Command, Parameter and end with ETX. You can add the required parameter.

- The projector can not receive any command for 10 seconds after the lamp is switched on. Wait 10 seconds before sending the command.
- If sending multiple commands, check that a response has been received from the projector for one command before sending the next command.
- When a command which does not require parameters to be sent, the colon (:) is not required.
- If an incorrect command is sent from the personal computer, the ER401 command will be sent from the projector to the personal computer.

## Technical Information

### Cable specifications

(When connected to a personal computer)

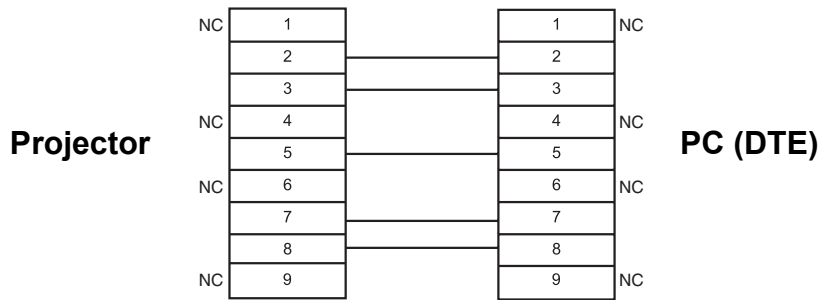

### Control commands

Command	Control contents	Remarks
PON	Power ON	In standby mode, all commands other than the PON command are ignored. ● The PON command is ignored during lamp ON control.
POF	Power OFF	If a PON command is received while the cooling fan is operating after the lamp has switched off, the lamp is not turned back on again straight away in order to protect the lamp.
AVL	Volume	Parameter 000 - 063 (Adjustment value 0 - 63)
IIS	INPUT	Parameter: VID = VIDEO RG1 = COMPUTER1 YUV = COMPONENT SVD = S-VIDEO RG2 = COMPUTER2 NWP = NETWORK (PT-F100NTE only)
Q\$\$	Lamp condition query	Call back 0 = Standby 1 = Lamp ON control active 2 = Lamp ON 3 = Lamp OFF control active
OSH	SHUTTER	Turning off the projection temporarily. Send the command to switch between ON and OFF. Do not send the command consecutively.

## Computer connection guidance

You can switch the signals which to output from the **COMPUTER1 OUT** terminal by pressing the computer key command. The key commands are depend on the manufactures. If you select the computer terminals which has no signals while the **INPUT GUIDE** is set to **DETAILED**, the computer connection guidance will be displayed.

Manufacturer	Key command	Manufacturer	Key command	Manufacturer	Key command
Panasonic NEC	<b>Fn</b> + <b>F3</b>	TOSHIBA SHARP HP	<b>Fn</b> + <b>F5</b>	IBM SONY	<b>Fn</b> + <b>F7</b>
				Apple	<b>F7</b>
FUJITSU	<b>Fn</b> + <b>F10</b>	EPSON DELL	<b>Fn</b> + <b>F8</b>	Other	<b>Fn</b> +

#### NOTE:

- The computer connection guidance will disappear after 5 minutes.
- Please refer the instructions which provided with the computers for more detailed information.

## REMOTE terminal

You can remotely operate the projector from the outside the **Remote control** range by connecting to the **REMOTE** terminal.

### Pin assignments and signal names

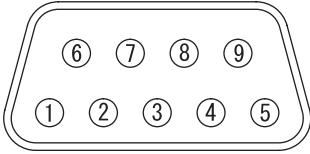
	Pin No.	Signal name	Contents
	①	GND	Ground
	②	POWER	POWER ON
	③	INPUT SEL3	Select input signal 3
	④		NC
	⑤	INPUT SEL1	Select input signal 1
	⑥	INPUT SEL2	Select input signal 2
	⑦		Connect internally
	⑧		
	⑨	ENABLE	Control by external contact

### LAMP switching

Pin No.	Settings	
② - ①	Short	Open
Operation	On	Off

### Switching input signals

Pin No.	Settings					
③ - ①	Open	Open	Short	Short	Short	Open
⑤ - ①	Open	Short	Open	Open	Short	Short
⑥ - ①	Open	Open	Short	Open	Open	Short
<b>Input signal</b>	COMPUTER1	COMPUTER2	COMPONENT	VIDEO	S-VIDEO	NETWORK

#### NOTE:

- When pin ① and pin ⑨ are short-circuited, the buttons on the projector's control panel, **POWER** and **INPUT SELECT** buttons on the **Remote control** cannot be used. In addition, the RS-232C commands and network functions that correspond to these functions cannot be used either.
- While pin ⑨ is "Open", do not short-circuit pin ①, ②, ③, ⑤ and ⑥. The projector would reject all the signals from the **Remote control**.

## Technical Information

### Specifications

<b>Power supply</b>		AC 100 - 240 V 50 Hz/60 Hz
<b>Power consumption</b>		330 W During standby (when fan is stopped): 3 W
<b>Amps</b>		3.9 A - 1.4 A
<b>LCD panel</b>	<b>Panel size (diagonal)</b>	0.7 type (17.78 mm)
	<b>Aspect ratio</b>	4 : 3
	<b>Display method</b>	3 transparent LCD panels (RGB)
	<b>Drive method</b>	Active matrix method
	<b>Pixels</b>	786 432 (1 024 x 768) x 3 panels
<b>Lens</b>		Manual zoom (2x)/Manual focus F 1.7 - 2.6, f 21.6 mm - 43.0 mm
<b>Lamp</b>		UHM lamp (250 W)
<b>Luminosity</b>		3 200 lm
<b>Operating environment</b>		Temperature 0 °C - 40 °C (32 °F - 104 °F) When the <b>HIGHLAND</b> (page 38) is set to ON: 0 °C - 35 °C (32 °F - 95 °F) Humidity 20% - 80% (no condensation)
<b>Scanning frequency*1 (for RGB signal)</b>	<b>Horizontal scanning frequency</b>	15 kHz - 91 kHz
	<b>Vertical scanning frequency</b>	50 Hz - 85 Hz
	<b>Dot clock frequency</b>	Less than 110 MHz
<b>COMPONENT (YPbPr) signals</b>		480i, 480p, 576i, 576p, 720/50p, 720/60p, 1 080/50i, 1 080/60i,
<b>Colour system</b>		7 (NTSC/NTSC 4.43/PAL/PAL-M/PAL-N/PAL60/SECAM)
<b>Projection size</b>		33" - 300" (838.2 mm - 7 620 mm)
<b>Throw distance</b>		1.2 m - 18.1 m (3'11" - 59'4")
<b>Screen aspect ratio</b>		4 : 3
<b>Installation</b>		FRONT/DESK, FRONT/CEILING, REAR/DESK, REAR/CEILING (Menu selection method)
<b>Speaker</b>		1 piece 4 cm (1 - 9/16")
<b>Max. useable volume output</b>		3.0 W

\*1. See "List of compatible signals" on page 46 for available signals.

<b>Terminals</b>	<b>S-VIDEO IN</b>	Single - line, Mini DIN 4p Y: 1.0 V [p-p], C: 0.286 V [p-p], 75 Ω
	<b>VIDEO IN</b>	Single - line, RCA pin jack 1.0 V [p-p], 75Ω
	<b>COMPONENT1 IN</b>	Single - line, D - sub HD 15-pin (female) R.G.B. 0.7 V [p-p], 75 Ω TTL high impedance, automatic positive/negative polarity compatible HD, VD/SYNC
	<b>COMPUTER2 IN/ 1 OUT</b>	Single - line, D - sub HD 15-pin (female) Selectable for input and output by menu operation. R.G.B. 0.7 V [p-p], 75 Ω TTL high impedance, automatic positive/negative polarity compatible HD, VD/SYNC
	<b>COMPONENT IN</b>	Y, PB/CB, PR/CR Single - line, RCA pin jack x 3 Y: 1.0 V [p-p] (including sync), 75 Ω PB/CB, (PR/CR) 0.7 V [p-p], 75 Ω
	<b>AUDIO IN</b>	Single - line, 0.5V [rms], RCA pin jack x 2 (L - R)
	<b>COMPUTER AUDIO IN</b>	Dual - line, 0.5V [rms], M3 jack (Stereo MINI)
	<b>VARIABLE AUDIO OUT</b>	Single - line, 0.5V [rms], M3 jack (Stereo MINI) Monitor output/stereo compatible 0 V [rms] - 2.0 V [rms] (variable)
	<b>SERIAL</b>	D-sub 9-pin RS-232C compatible
	<b>REMOTE</b>	D-sub 9-pin For external control
	<b>LAN (RJ-45) (PT-F100NTE only)</b>	Single - line, For network connection 10 Base-T/100Base-TX/1000Base-T
<b>Wireless LAN</b>	<b>Compatible</b>	IEEE802.11b/IEEE802.11g (Wireless LAN standard protocol)
	<b>Wireless channel</b>	IEEE802.11b/IEEE802.11g: 1 - 13 channels
	<b>Distance</b>	30 m (98'5") Depends on the usage environment
<b>Cabinet</b>	Moulded plastic (PC+ABS)	
<b>Dimensions</b>	Width	432 mm (17")
	Height	124.5 mm (4 - 7/8")
	Length	319 mm (12 - 17/32")
<b>Weight</b>	6.2 kg (13.7 lbs.)	
<b>Certifications</b>	EN60950-1, EN55022, EN61000-3-2, EN61000-3-3, EN55024	
<b>Remote control</b>	<b>Power supply</b>	3 V DC (AA battery x 2)
	<b>Operating range</b>	Approx. 15 m (49'2") (when operated directly in front of signal receptor)
	<b>Weight</b>	117 g (4.2 ozs.) (including batteries)
	<b>Dimensions</b>	Width 48 mm (1 - 7/8") Length 163 mm (6 - 13/32") Height 24.5 mm (-15/16") (not including surface projection parts)
<b>Options</b>	<b>Ceiling bracket</b>	ET-PKF100H/ET-PKF100S

## Technical Information

### Screen size and throw distance for 16:9 aspect ratio

Projection size (16 : 9)			Throw distance (L)	
Screen Diagonal (SD)	Screen height (SH)	Screen width (SW)	Minimum distance (LW)	Maximum distance (LT)
(0.84 m) 33"	0.41 m (1'4")	0.73 m (2'4")		2.1 m (6'10")
(1.02 m) 40"	0.50 m (1'7")	0.89 m (2'11")	1.3 m (4'3")	2.6 m (8'6")
(1.27 m) 50"	0.62 m (2')	1.11 m (3'7")	1.6 m (5'2")	3.2 m (10'5")
(1.52 m) 60"	0.75 m (2'5")	1.33 m (4'4")	1.9 m (6'2")	3.9 m (12'9")
(1.78 m) 70"	0.87 m (2'10")	1.55 m (5'1")	2.3 m (7'6")	4.6 m (15'1")
(2.03 m) 80"	1.00 m (3'3")	1.77 m (5'9")	2.6 m (8'6")	5.2 m (17')
(2.29 m) 90"	1.12 m (3'8")	1.99 m (6'6")	2.9 m (9'6")	5.9 m (19'4")
(2.54 m) 100"	1.25 m (4'1")	2.21 m (7'3")	3.3 m (10'9")	6.5 m (21'3")
(3.05 m) 120"	1.49 m (4'10")	2.66 m (8'8")	3.9 m (12'9")	7.9 m (25'11")
(3.81 m) 150"	1.87 m (6'1")	3.32 m (10'10")	4.9 m (16')	9.8 m (32'1")
(5.08 m) 200"	2.49 m (8'2")	4.43 m (14'6")	6.6 m (21'7")	13.1 m (42'11")
(6.35 m) 250"	3.11 m (10'2")	5.53 m (18'1")	8.3 m (27'2")	16.4 m (53'9")
(7.62 m) 300"	3.74 m (12'3")	6.64 m (21'9")	9.9 m (32'5")	19.7 m (64'7")

\* All measurements above are approximate and may differ slightly from the actual measurements.

#### ■ Calculation methods for screen dimensions

You can calculate more detailed screen dimension from the screen diagonal.

$$SW (m) = SD (") \times 0.0221$$

$$SH (m) = SD (") \times 0.0125$$

$$LW (m) = 0.0332 \times SD (") - 0.049$$

$$LT (m) = 0.066 \times SD (") - 0.055$$

\* The results above are approximate and may differ slightly from the actual measurements.

## Dimensions

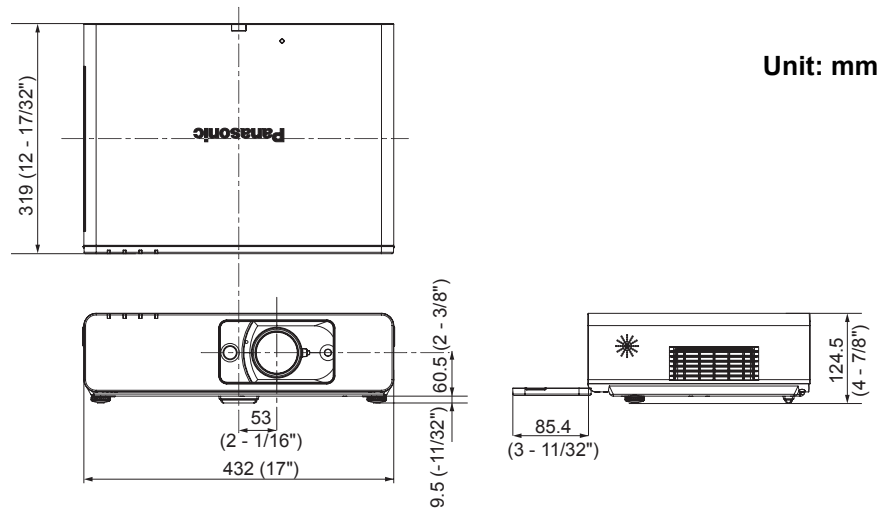

## Trademark acknowledgements

- VGA and XGA are trademarks of International Business Machines Corporation.
- S-VGA is a registered trademark of the Video Electronics Standards Association.
- HDMI, the HDMI logo and High-Definition Multimedia Interface are trademarks or registered trademarks of HDMI Licensing LLC.
- The font used in the on-screen displays is a Ricoh bitmap font, which is manufactured and sold by Ricoh Company, Ltd.

All other trademarks are the property of the various trademark owners.

# Index

<b>A</b>	
AC IN .....	15
Accessories .....	11
Air exhaust port .....	15
Air intake port .....	14
ALS (Ambient Luminance Sensor) .....	14
ARF (Auto Rolling Filter)	
Compartment .....	15
FILTER indicator .....	14
FILTER indicator status .....	41
FILTER REMAINING .....	36
Replacing .....	42
ASPECT .....	34
AUDIO BALANCE .....	38
AUDIO IN .....	15
AUTO SETUP	
Menu .....	37
Remote control .....	25
Remote control button .....	13
<b>B</b>	
BACK COLOR .....	38
Battery compartment .....	13
BLACKBOARD .....	38
BRIGHTNESS .....	32
<b>C</b>	
Calculation methods	
16:9 .....	52
4:3 .....	16
CD-ROM	
Accessories .....	11
Cleaning .....	42
CLOCK PHASE .....	34
COLOR .....	32
COLOR TEMPERATURE .....	32
COMPONENT IN .....	15
COMPUTER	
Connection guidance .....	48
Remote control .....	26
Remote control button .....	13
COMPUTER AUDIO IN .....	15
COMPUTER SEARCH .....	13
COMPUTER1 IN .....	15
COMPUTER2 IN/1 OUT .....	15
COMPUTER2 SELECT .....	36
Connections .....	20
CONTRAST .....	32
CONTROL PANEL .....	37
<b>D</b>	
DAYLIGHT VIEW .....	32
DEFAULT	
Remote control .....	27
Remote control button .....	13
DETAILED SETUP	
OPTION menu .....	38
PICTURE menu .....	33
DIGITAL ZOOM	
Remote control .....	28
Remote control button .....	13
Dimensions .....	53
Direct power off .....	22
<b>E</b>	
DIRECT POWER ON	
Function .....	22
Menu .....	37
DOT CLOCK .....	34
<b>E</b>	
ENTER	
Control panel button .....	14
Remote control button .....	13
<b>F</b>	
FILTER REMAINING .....	36
FILTER SETUP .....	36
Focus lever .....	14, 24
FRAME LOCK .....	35
FREEZE	
Remote control .....	27
Remote control button .....	13
Front leg adjusters .....	15, 17, 24
Front panel cover .....	14
<b>H</b>	
Hand strap .....	13
HIGHLAND .....	38
<b>I</b>	
INDEX-WINDOW	
Remote control .....	27
Remote control button .....	13
INITIALIZE ALL .....	38
INPUT GUIDE .....	36
INPUT PASSWORD .....	39
INPUT SELECT	
Control panel button .....	14
Remote control button .....	13
Selecting .....	24, 26
INSTALLATION	
Menu .....	37
Projection method .....	17
<b>K</b>	
KEYSTONE .....	34
<b>L</b>	
LAMP	
Indicator .....	14
Indicator status .....	41
LAMP RUNTIME .....	37
Lamp unit compartment .....	15
Replacing .....	43
LAN .....	15
LANGUAGE .....	30
LASER	
Remote control .....	26
Remote control button .....	13
Lens shift lever .....	14, 18, 24
Lever	
Focus lever .....	14
Lens shift lever .....	14
Zoom lever .....	14

<b>M</b>		SERIAL .....	15
Mains lead		Basic format .....	47
Accessories .....	11	Cable specifications .....	48
Connecting .....	22	Communication settings .....	47
<b>MENU</b>		Connection .....	47
Control panel button .....	14	Control commands .....	48
Main menu .....	30	Pin assignments .....	47
Navigation .....	29	<b>SHARPNESS</b> .....	32
Remote control button .....	13	<b>SHUTTER</b>	
<b>N</b>		Remote control .....	27
Navigation buttons		Remote control button .....	13
Control panel button .....	14	<b>SIGNAL SEARCH</b> .....	37
Remote control button .....	13	Speaker .....	14
<b>NETWORK</b>		Specifications .....	50
Remote control .....	26	<b>STARTUP LOGO</b> .....	36
Remote control button .....	13	<b>STILL MODE</b> .....	33
<b>NOISE REDUCTION</b> .....	33	Sub-menu .....	30
<b>O</b>		<b>S-VIDEO IN</b> .....	15
OPTION menu .....	36	<b>SXGA MODE</b> .....	38
OSD DESIGN .....	38	<b>T</b>	
<b>P</b>		Technical Information .....	46
PAGE .....	13	TEMP	
PASSWORD CHANGE .....	39	Indicator .....	14
PICTURE menu .....	32	Indicator status .....	41
PICTURE MODE .....	32	TEST PATTERN .....	38
POSITION .....	34	TEXT CHANGE .....	39
POSITION menu .....	34	TEXT DISPLAY .....	39
<b>POWER</b>		Throw distance	
Control panel .....	14	16:9 .....	52
Indicator .....	14	4:3 .....	16
Indicator status .....	22	Throwing angle .....	17
Remote control button .....	13	TINT .....	32
<b>POWER OFF TIMER</b> .....	37	Troubleshooting .....	45
Projection lens .....	14	<b>TV-SYSTEM</b> .....	33
<b>R</b>		<b>V</b>	
REMOTE .....	15	VARIABLE AUDIO OUT .....	15
LAMP switching .....	49	VIDEO	
Pin assignments .....	49	Remote control .....	26
Switching input signals .....	49	Remote control button .....	13
Remote control		VIDEO IN .....	15
Accessories .....	11	VOLUME .....	38
Indicator .....	13	Remote control .....	28
Signal emitter .....	13	Remote control button .....	13
Signal receptor .....	14	<b>W</b>	
<b>RESIZING</b> .....	35	WHITE BALANCE .....	33
<b>RETURN</b>		<b>X</b>	
Control panel button .....	14	XGA MODE .....	38
Remote control button .....	13	<b>Z</b>	
<b>S</b>		Zoom lever .....	14, 24
Safety cable			
Accessories .....	11		
Safeguards .....	44		
Screen size			
16:9 .....	52		
4:3 .....	16		
Security lock .....	15		
<b>SECURITY menu</b> .....	39		

---

**Matsushita Electric Industrial Co., Ltd.**

Web Site: <http://panasonic.net>