

# SHARP®

## OPERATION MANUAL



# Notevision

MODEL

# PG-M15X PG-M15S

DIGITAL  
MULTIMEDIA  
PROJECTOR



香港電器安全規格  
(國際電工委員會規格適合)

Important  
Information



Setup & Connections



Operation



Useful Features



Maintenance &  
Troubleshooting



Appendix



This equipment complies with the requirements of Directives 89/336/EEC and 73/23/EEC as amended by 93/68/EEC.

Dieses Gerät entspricht den Anforderungen der EG-Richtlinien 89/336/EWG und 73/23/EWG mit Änderung 93/68/EWG.

Ce matériel répond aux exigences contenues dans les directives 89/336/CEE et 73/23/CEE modifiées par la directive 93/68/CEE.

Dit apparaat voldoet aan de eisen van de richtlijnen 89/336/EEG en 73/23/EEG, gewijzigd door 93/68/EEG.

Dette udstyr overholder kravene i direktiv nr. 89/336/EEC og 73/23/EEC med tillæg nr. 93/68/EEC.

Quest' apparecchio è conforme ai requisiti delle direttive 89/336/EEC e 73/23/EEC, come emendata dalla direttiva 93/68/EEC.

Η εγκατάσταση αυτή ανταποκρίνεται στις απαιτήσεις των οδηγιών της Ευρωπαϊκής Ένωσης 89/336/EOK και 73/23/EOK, όπως οι κανονισμοί αυτοί συμπληρώθηκαν από την οδηγία 93/68/EOK.

Este equipamento obedece às exigências das directivas 89/336/CEE e 73/23/CEE, na sua versão corrigida pela directiva 93/68/CEE.



Este aparato satisface las exigencias de las Directivas 89/336/CEE y 73/23/CEE, modificadas por medio de la 93/68/CEE.

Denna utrustning uppfyller kraven enligt riktlinjerna 89/336/EEC och 73/23/EEC så som kompletteras av 93/68/EEC.

Dette produktet oppfyller betingelsene i direktivene 89/336/EEC og 73/23/EEC i endringen 93/68/EEC.

Tämä laite täyttää direktiivien 89/336/EEC ja 73/23/EEC vaatimukset, joita on muutettu direktiivillä 93/68/EEC.

#### **SPECIAL NOTE FOR USERS IN THE U.K.**

The mains lead of this product is fitted with a non-rewireable (moulded) plug incorporating a 3A fuse. Should the fuse need to be replaced, a BSI or ASTA approved BS 1362 fuse marked  or  and of the same rating as above, which is also indicated on the pin face of the plug, must be used.

Always refit the fuse cover after replacing the fuse. Never use the plug without the fuse cover fitted.

In the unlikely event of the socket outlet in your home not being compatible with the plug supplied, cut off the mains plug and fit an appropriate type.

#### **DANGER:**

The fuse from the cut-off plug should be removed and the cut-off plug destroyed immediately and disposed of in a safe manner.

Under no circumstances should the cut-off plug be inserted elsewhere into a 3A socket outlet, as a serious electric shock may occur.

To fit an appropriate plug to the mains lead, follow the instructions below:

#### **IMPORTANT:**

The wires in the mains lead are coloured in accordance with the following code:

Blue: Neutral

Brown: Live

As the colours of the wires in the mains lead of this product may not correspond with the coloured markings identifying the terminals in your plug, proceed as follows:

- The wire which is coloured blue must be connected to the plug terminal which is marked N or coloured black.
  - The wire which is coloured brown must be connected to the plug terminal which is marked L or coloured red.
- Ensure that neither the brown nor the blue wire is connected to the earth terminal in your three-pin plug.

Before replacing the plug cover make sure that:

- If the new fitted plug contains a fuse, its value is the same as that removed from the cut-off plug.
- The cord grip is clamped over the sheath of the mains lead, and not simply over the lead wires.

IF YOU HAVE ANY DOUBT, CONSULT A QUALIFIED ELECTRICIAN.

Before using the projector, please read this operation manual carefully.

# OPERATION MANUAL

ENGLISH

## IMPORTANT

For your assistance in reporting the loss or theft of your projector, please record the Serial Number located on the bottom of the projector and retain this information. Before recycling the packaging, please be sure that you have checked the contents of the carton thoroughly against the list of "Supplied Accessories" on page 12.

**Model No.: PG-M15X**  
**Serial No.:**

**Model No.: PG-M15S**  
**Serial No.:**

There are two important reasons for prompt warranty registration of your new SHARP Projector, using the REGISTRATION CARD packed with the projector.

### 1. WARRANTY

This is to assure that you immediately receive the full benefit of the parts, service and labor warranty applicable to your purchase.

### 2. CONSUMER PRODUCT SAFETY ACT



To ensure that you will promptly receive any safety notification of inspection, modification, or recall that SHARP may be required to give under the 1972 Consumer Product Safety Act, PLEASE READ CAREFULLY THE IMPORTANT "LIMITED WARRANTY" CLAUSE.

U.S.A. ONLY

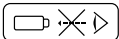
**WARNING:** High brightness light source. Do not stare into the beam of light, or view directly. Be especially careful that children do not stare directly into the beam of light.



**WARNING:** To reduce the risk of fire or electric shock, do not expose this product to rain or moisture.

	<b>CAUTION</b> <b>RISK OF ELECTRIC SHOCK.</b> <b>DO NOT REMOVE SCREWS</b> <b>EXCEPT SPECIFIED USER</b> <b>SERVICE SCREWS.</b>	
<b>CAUTION: TO REDUCE THE RISK OF ELECTRIC SHOCK,</b> <b>DO NOT REMOVE COVER.</b> <b>NO USER-SERVICEABLE PARTS EXCEPT LAMP UNIT.</b> <b>REFER SERVICING TO QUALIFIED SERVICE</b> <b>PERSONNEL.</b>		



The lightning flash with arrowhead symbol, within an equilateral triangle, is intended to alert the user to the presence of uninsulated "dangerous voltage" within the product's enclosure that may be of sufficient magnitude to constitute a risk or electric shock to persons.



The exclamation point within a triangle is intended to alert the user to the presence of important operating and maintenance (servicing) instructions in the literature accompanying the product.

**WARNING:** FCC Regulations state that any unauthorized changes or modifications to this equipment not expressly approved by the manufacturer could void the user's authority to operate this equipment.

U.S.A. ONLY

## INFORMATION

This equipment has been tested and found to comply with the limits for a Class A digital device, pursuant to Part 15 of the FCC Rules. These limits are designed to provide reasonable protection against harmful interference in a residential installation. This equipment generates, uses, and can radiate radio frequency energy and, if not installed and used in accordance with the operation manual, may cause harmful interference to radio communications. However, there is no guarantee that interference will not occur in a particular installation. If this equipment does cause harmful interference to radio or television reception, which can be determined by turning the equipment off and on, the user is encouraged to try to correct the interference by one or more of the following measures:

- Reorient or relocate the receiving antenna.
- Increase the separation between the equipment and the receiver.
- Connect the equipment into an outlet on a circuit different from that to which the receiver is connected.
- Consult the dealer or an experienced radio/TV technician for help.

U.S.A. ONLY

The enclosed computer cable must be used with the device. The cable is provided to ensure that the device complies with FCC Class A verification.

U.S.A. ONLY

**WARNING:**

This is a class A product. In a domestic environment this product may cause radio interference in which case the user may be required to take adequate measures.

**WARNING:**

The cooling fan in this projector continues to run for about 90 seconds after the projector is turned off. During normal operation, when turning the power off, always use the **ON/OFF** button on the projector or the **POWER** button on the remote control. Ensure the cooling fan has stopped before disconnecting the power cord. DURING NORMAL OPERATION, NEVER TURN THE PROJECTOR OFF BY DISCONNECTING THE POWER CORD. FAILURE TO OBSERVE THIS WILL RESULT IN PREMATURE LAMP FAILURE.

**PRODUCT DISPOSAL**

This product utilizes tin-lead solder, and high intensity discharge lamp (HID lamp) containing a small amount of mercury. Disposal of these materials may be regulated due to environmental considerations. For disposal or recycling information, please contact your local authorities or the Electronics Industries Alliance: [www.eiae.org](http://www.eiae.org).

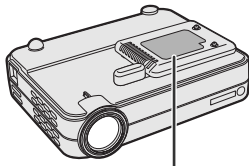
**Caution Concerning the Lamp Replacement**

See "Replacing the Projection Lamp" on pages 47 and 48.

**LAMP REPLACEMENT CAUTION**

BEFORE REMOVING THE SCREW, DISCONNECT POWER CORD. HOT SURFACE INSIDE. ALLOW 1 HOUR TO COOL BEFORE REPLACING THE LAMP. REPLACE WITH SAME SHARP LAMP UNIT TYPE BQC-PGM15X//1 ONLY. UV RADIATION: CAN CAUSE EYE DAMAGE. TURN OFF LAMP BEFORE SERVICING. MEDIUM PRESSURE LAMP: RISK OF EXPLOSION. POTENTIAL HAZARD OF GLASS PARTICLES IF LAMP HAS RUPTURED. HANDLE WITH CARE. SEE OPERATION MANUAL.

**PRECAUTIONS A OBSERVER LORS DU REMPLACEMENT DE LA LAMPE.**

DEBRANCHER LE CORDON D'ALIMENTATION AVANT DE RETIRER LES VIS. L'INTERIEUR DU BOITIER ETANT EXTREMEMENT CHAUD, ATTENDRE 1 HEURE AVANT DE PROCEDER AU REMPLACEMENT DE LA LAMPE. NE REMPLACER QUE PAR UNE LAMPE SHARP DE TYPE BQC-PGM15X//1. RAYONS ULTRAVIOLETS: PEUVENT ENDOMMAGER LES YEUX. ETEINDRE LA LAMPE AVANT DE PROCEDER A L'ENTRETIEN. LAMPE A MOYENNE PRESSION: RISQUE D'EXPLOSION. DANGER POTENTIEL DE PARTICULES DE VERRE EN CAS D'ECLATEMENT DE LA LAMPE. A MANIPULER AVEC PRECAUTION, SE REPORTER AU MODE D'EMPLOI.

 **USER SERVICE SCREWS**  
**VIS POUR ENTRETIEN PAR L'UTILISATEUR**



# IMPORTANT SAFEGUARDS



Electrical energy can perform many useful functions. This product has been engineered and manufactured to ensure your personal safety. However IMPROPER USE CAN RESULT IN POTENTIAL ELECTRICAL SHOCK OR FIRE HAZARD. In order not to defeat the safeguards incorporated into this Projector, observe the following basic rules for its installation, use and servicing. For your own protection and reliable usage of your projector, please be sure to read these "IMPORTANT SAFEGUARDS" carefully before use.

## 1. Read Instructions

All the safety and operating instructions should be read before the product is operated.

## 2. Retain Instructions

The safety and operating instructions should be retained for future reference.

## 3. Heed Warnings

All warnings on the product and in the operating instructions should be adhered to.

## 4. Follow Instructions

All operating and use instructions should be followed.

## 5. Cleaning

- Unplug this product from the wall outlet before cleaning. Do not use liquid cleaners or aerosol cleaners. Use a damp cloth for cleaning.
- Never use strong detergents or solvents such as alcohol or thinner.
- Use a blower or lens paper to clean the lens, and be careful not to scratch or mar the lens.

## 6. Attachments

Do not use attachments not recommended by the product manufacturer as they may cause hazards.

## 7. Water and Moisture

Do not use this product near water—for example, near a bathtub, wash bowl, kitchen sink, or laundry tub; in a wet basement; or near a swimming pool; and the like.

## 8. Accessories

Do not place this product on an unstable cart, stand, tripod, bracket, or table. The product may fall, causing serious injury to a child or adult, and serious damage to the product. Use only with a cart, stand, tripod, bracket, or table recommended by the manufacturer, or sold with the product. Any mounting of the product should follow the manufacturer's instructions, and should use a mounting accessory recommended by the manufacturer.

## 9. Transportation

A product and cart combination should be moved with care. Quick stops, excessive force, and uneven surfaces may cause the product and cart combination to overturn.



## 10. Ventilation

Slots and openings in the cabinet are provided for ventilation to ensure reliable operation of the product and to protect it from overheating. The openings should never be covered or blocked by placing the product on a bed, sofa, rug, or other similar surface. This product should not be placed in a built-in installation such as a bookcase or rack unless proper ventilation is provided or the manufacturer's instructions have been adhered to.

## 11. Power Sources

This product should be operated only from the type of power source indicated on the marking label. If you are not sure of the type of power supply to your home, consult your product dealer or local power company. For products intended to operate from battery power, or other sources, refer to the operating instructions.

## 12. Grounding or Polarization

This product is provided with one of the following types of plugs. If the plug should fail to fit into the power outlet, please contact your electrician.

Do not defeat the safety purpose of the plug.

- a. Two-wire type (mains) plug.
- b. Three-wire grounding type (mains) plug with a grounding terminal.  
This plug will only fit into a grounding type power outlet.

## 13. Power-Cord Protection

Power-supply cords should be routed so that they are not likely to be walked on or pinched by items placed upon or against them, paying particular attention to cords at plugs, convenience receptacles, and the point where they exit from the product.

## 14. Lightning

For added protection for this product during a lightning storm, or when it is left unattended and unused for long periods of time, unplug it from the wall outlet and disconnect the power cord. This will prevent damage to the product due to lightning and power-line surges.

## 15. Overloading

Do not overload wall outlets, extension cords, or integral convenience receptacles as this can result in a risk of fire or electric shock.

## 16. Object and Liquid Entry

Never push objects of any kind into this product through openings as they may touch dangerous voltage points or short-out parts that could result in a fire or electric shock. Never spill liquid of any kind on the product.

## 17. Servicing

Do not attempt to service this product yourself as opening or removing covers may expose you to dangerous voltage or other hazards. Refer all servicing to qualified service personnel.

## 18. Damage Requiring Service

Unplug this product from the wall outlet and refer servicing to qualified service personnel under the following conditions:

- a. If the power-supply cord or plug is damaged.
- b. If liquid has been spilled, or objects have fallen into the product.
- c. If the product has been exposed to rain or water.
- d. If the product does not operate normally by following the operating instructions. Adjust only those controls that are covered by the operating instructions, as an improper adjustment of other controls may result in damage and will often require extensive work by a qualified technician to restore the product to normal operation.
- e. If the product has been dropped or damaged in any way.
- f. If the product exhibits a distinct change in performance, this indicates a need for service.

## 19. Replacement Parts

When replacement parts are required, be sure the service technician has used replacement parts specified by the manufacturer or with the same characteristics as the original part. Unauthorized substitutions may result in fire, electric shock, or other hazards.

## 20. Safety Check

Upon completion of any service or repairs to this product, ask the service technician to perform safety checks to determine that the product is in proper operating condition.

## 21. Heat

This product should be situated away from heat sources such as radiators, heat registers, stoves, or other products (including amplifiers) that produce heat.



# IMPORTANT SAFEGUARDS



## 22. Installation

- For best results, use the product in a darkened room.
- Place the product on a flat, level surface in a dry area away from dust and moisture.
- Do not place the product in direct sunlight, near heaters or heat radiating appliances.
- Exposure to direct sunlight, smoke or steam can harm internal components.
- Handle the product carefully. Dropping or jarring can damage internal components.
- Do not place heavy objects on top of the product.

## 23. Power Supply

- The product is designed to operate on a power supply of 100 to 240 V 50/60 Hz AC. Ensure that your power supply fits these requirements before attempting to use the unit.
- For PLUGGABLE EQUIPMENT, the socket-outlet shall be installed near the equipment and shall be accessible.
- Disconnect the power cable (main lead) from the power outlet after using the product.  
Before disconnecting the power cable, make sure the POWER indicator lamp is orange and not flashing.
- Handle the power cable carefully and avoid excessive bending. A damaged cord can cause electric shock or fire.

## 24. Lamp Replacement

- Be sure to replace the lamp when the LAMP indicator comes on. If you continue to use the lamp after 1,500 hours of usage, the lamp will turn off (See pages 47 and 48).

## 25. Fire and Shock Precautions

- Ensure that there is sufficient ventilation and that vents are unobstructed to prevent the buildup of heat inside the product. Allow at least 7 7/8 inches (20 cm) of space between the unit and surrounding obstructions.
- Prevent foreign objects such as paper clips and bits of paper from falling into the product. Do not attempt to retrieve any objects that fell into the product. Do not insert any metal objects such as a wire or screwdriver into the product. If something should fall into the product, immediately disconnect the power cable from the product and have the object removed by a Sharp Authorized Projector Dealer or Service Center.
- Do not place any liquids on top of the product.
- **Do not look into the lens while the product is on. Serious damage to your eyes could result.**

### IMPORTANT

- DLP (Digital Light Processing) and DMD (Digital Micromirror Device) are trademarks of Texas Instruments, Inc.
- Microsoft and Windows are registered trademarks in the United States and other countries of Microsoft Corporation.
- PC/AT is a registered trademark in the United States of International Business Machines Corporation.
- Macintosh is a registered trademark in the United States and other countries of Apple Computer, Inc.
- The other company and product names mentioned are trademarks or registered trademarks of each respective company.





# Outstanding Features



## 1. **SMALL, LIGHTWEIGHT & USER-FRIENDLY DESIGN**

Small and lightweight design (3.5 lbs/1.6 kg, 2.0 liter) enhances projector portability.

## 2. **1.2× MANUAL ZOOM/FOCUS**

Adjusts image size without relocating the projector.

## 3. **EASY-TO-USE GRAPHICAL USER INTERFACE (GUI)**

Multi-color interface lets you select functions easily.

## 4. **AUTO SYNC TECHNOLOGY FOR AUTOMATIC IMAGE OPTIMIZATION**

Automatically makes any necessary adjustments for perfectly synced computer images.

## 5. **HIGH RESOLUTION IMAGES WITH INTELLIGENT COMPRESSION TECHNOLOGY**

### **PG-M15X**

Native **XGA resolution** (1,024 × 768) and compatibility with SXGA using intelligent compression

### **PG-M15S**

Native **SVGA resolution** (800 × 600) and compatibility with SXGA and XGA using intelligent compression

## 6. **DIRECT DIGITAL COMPUTER INPUT (DVI)**

Signals remain digital from the source device to the projector resulting in sharper, clearer, noiseless and adjustment-free computer images.

## 7. **RGB MONITOR OUTPUT TERMINAL**

Presenters can simultaneously view their presentation on a LCD or CRT display while the image is being projected to an audience.

## 8. **ANTI-ALIASING DIGITAL KEystone CORRECTION**

Digitally adjusts image projected at an angle to maintain overall image quality and brightness.

## 9. **WIRELESS MOUSE REMOTE CONTROL**

Allows you to operate the projector and your computer mouse.

## 10. **COLOR TEMPERATURE ADJUSTMENT**

Ensures perfect color rendering.

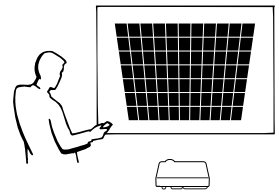



# Contents

Important Information

## Important Information

<b>IMPORTANT SAFEGUARDS</b> .....	3
<b>Outstanding Features</b> .....	5
<b>Contents</b> .....	6
<b>Usage Guidelines</b> .....	7
<b>How to Access the PDF Operation Manuals</b> (for Windows and Macintosh) .....	8
<b>Part Names</b> .....	9

## Setup & Connections

<b>Supplied Accessories</b> .....	12
<b>Connecting the Projector</b> .....	13

## Operation

<b>Basic Operations</b> .....	18
<b>Setting up the Screen</b> .....	20
<b>Operating the Wireless Mouse from the</b> <b>Remote Control</b> .....	24
<b>Using the GUI (Graphical User Interface)</b> <b>Menu Screens</b> .....	26
<b>Selecting the On-screen Display Language</b> ...	30
<b>Selecting the Video Input System Mode</b> (INPUT 2 or 3 only) .....	30
<b>Picture Adjustments</b> .....	31
Adjusting the Picture .....	31
Selecting the Color Temperature .....	32
<b>Computer Image Adjustments</b> (INPUT 1 (RGB) mode only) .....	33
Auto Sync Adjustment .....	33
Adjusting the Computer Image .....	33

## Useful Features

<b>Freeze Function</b> .....	34
<b>Digital Image Magnification</b> .....	35
<b>Selecting the Picture Display Mode</b> .....	36
<b>Gamma Correction</b> .....	38
<b>Checking the Input Signal</b> (INPUT 1 (DVI) or (RGB) mode only) .....	39
<b>Checking the Lamp Usage Time</b> .....	39
<b>Turning On/Off the AV Mute Message</b> .....	40
<b>On-screen Display Override Function</b> .....	41
<b>Automatic Power Shutoff Function</b> .....	42
<b>Detecting the Input Source Automatically</b> .....	43
<b>Selecting a Background Image</b> .....	43
<b>Reverse/Invert Image Function</b> .....	44

## Maintenance & Troubleshooting

<b>Lamp/Maintenance Indicators</b> .....	46
<b>Replacing the Projection Lamp</b> .....	47
<b>Using the Kensington Lock</b> .....	48
<b>Troubleshooting</b> .....	48

## Appendix

<b>Using the Soft Carrying Pouch</b> .....	49
<b>Connection Pin Assignments</b> .....	50
<b>RS-232C Port Specifications</b> .....	52
<b>Computer Compatibility Chart</b> .....	53
<b>Specifications</b> .....	54
<b>Dimensions</b> .....	55
<b>Glossary</b> .....	56
<b>Index</b> .....	57
<b>For SHARP Assistance</b> .....	58

Setup & Connections

Operation

Useful Features

Maintenance & Troubleshooting

Appendix





# Usage Guidelines

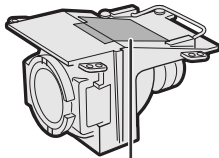

## Caution Concerning the Lamp Unit

Potential hazard of glass particles if lamp ruptures. Please have Sharp Authorized Projector Dealer or Service Center replace lamp if rupture occurs. See "Replacing the Projection Lamp" on pages 47 and 48.



95°F (+35°C)  
41°F (+5°C)

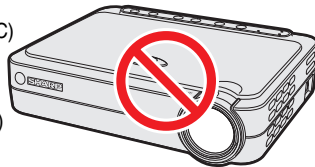

## Cautions Concerning the Setup of the Projector

For minimal servicing and to maintain high image quality, SHARP recommends that this projector be installed in an area free from humidity, dust and cigarette smoke. When the projector is subjected to these environments, the lens must be cleaned more often. Periodically the projector should be cleaned internally. As long as the projector is properly maintained in this manner, use in these environments will not reduce the overall operation life. Please note that all internal cleaning must be performed by a Sharp Authorized Projector Dealer or Service Center.

- Do not expose the projector to extreme heat or cold.  
Operating temperature: 41°F to 95°F (+5°C to +35°C)  
Storage temperature: 14°F to 140°F (-10°C to +60°C)

## Notes on Operation

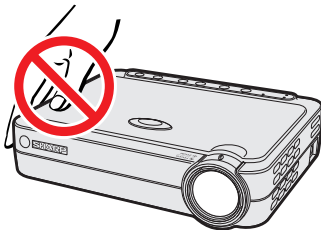
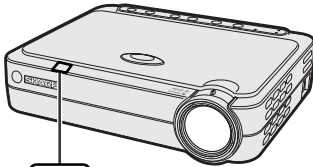

- The mark shown on the left calls the user's attention to locations on the projector that emit intense heat during operation.
- The exhaust vent, the lamp cage cover and adjacent areas may be extremely hot during projector operation. To prevent injury, do not touch these areas until they have sufficiently cooled.
- Allow at least 4 inches (10 cm) of space between the cooling fan (exhaust vent) and the nearest wall or obstruction.
- If the cooling fan becomes obstructed, a protection device will automatically turn off the projector lamp. This does not indicate a malfunction. Remove the projector power cord from the wall outlet and wait at least 10 minutes. Then reconnect the power cord and restart the projector. This will return the projector to normal operating condition.



TEMP.

## Temperature Monitor Function

If the projector starts to overheat due to setup problems, "TEMP." will appear in the lower-left corner of the picture. If the temperature continues to rise, the lamp will turn off, the TEMPERATURE WARNING indicator on the projector will flash, and after a 90-second cooling-off period the power will shut off. Refer to "Lamp/Maintenance Indicators" on page 46, for details.

### NOTE

- The cooling fan regulates the internal temperature, and its performance is automatically controlled. The sound of the fan may change during projector operation due to changes in the fan speed.



LAMP

## Lamp Monitor Function

When the projector is turned on after the lamp has been used for 1,400 hours, "LAMP" will appear in the lower-left corner of the picture to advise you to replace the lamp. See pages 47 and 48 for lamp replacement. If the lamp has been used for 1,500 hours, the projector power will automatically turn off and the projector will enter standby mode. Refer to "Lamp/Maintenance Indicators" on page 46, for details.



# How to Access the PDF Operation Manuals (for Windows and Macintosh)



PDF operation manuals in several languages are included in the CD-ROM. To utilize these manuals, you need to install Adobe Acrobat Reader on your PC (Windows or Macintosh). If you have not installed Acrobat Reader yet, you can download it from the Internet (<http://www.adobe.com>) or install it from the CD-ROM.

## To Install Acrobat Reader from the CD-ROM

### For Windows:

- ① Insert the CD-ROM in the CD-ROM drive.
- ② Double click on the “My Computer” icon.
- ③ Double click on the “CD-ROM” drive.
- ④ Double click on the “manuals” folder.
- ⑤ Double click on the “acrobat” folder.
- ⑥ Double click on the “windows” folder.
- ⑦ Double click on the desired installation program and follow the instructions on the screen.

### For Macintosh:

- ① Insert the CD-ROM in the CD-ROM drive.
- ② Double click on the “CD-ROM” icon.
- ③ Double click on the “manuals” folder.
- ④ Double click on the “acrobat” folder.
- ⑤ Double click on the “mac” folder.
- ⑥ Double click on the desired installation program and follow the instructions on the screen.

### For other operating systems:

Please download Acrobat Reader from the Internet (<http://www.adobe.com>).

### For other languages:

If you prefer using Acrobat Reader for languages other than those included in the CD-ROM, please download the appropriate version from the Internet.

## Accessing the PDF Manuals

### For Windows:

- ① Insert the CD-ROM in the CD-ROM drive.
- ② Double click on the “My Computer” icon.
- ③ Double click on the “CD-ROM” drive.
- ④ Double click on the “manuals” folder.
- ⑤ Double click on the “pg-m15” folder.
- ⑥ Double click on the language (name of the folder) that you want to view.
- ⑦ Double click on the pdf file.

### For Macintosh:

- ① Insert the CD-ROM in the CD-ROM drive.
- ② Double click on the “CD-ROM” icon.
- ③ Double click on the “manuals” folder.
- ④ Double click on the “pg-m15” folder.
- ⑤ Double click on the language (name of the folder) that you want to view.
- ⑥ Double click on the pdf file.

### NOTE

- If the desired pdf file cannot be opened by double clicking the mouse, start Acrobat Reader first, then specify the desired file using the “File”, “Open” menu.
- See the “readme.txt” file on the CD-ROM for important information on the CD-ROM not included in this operation manual.



# Part Names

Numbers next to the part names refer to the main pages in this manual where the topic is explained.



## Projector

### Front and Top View

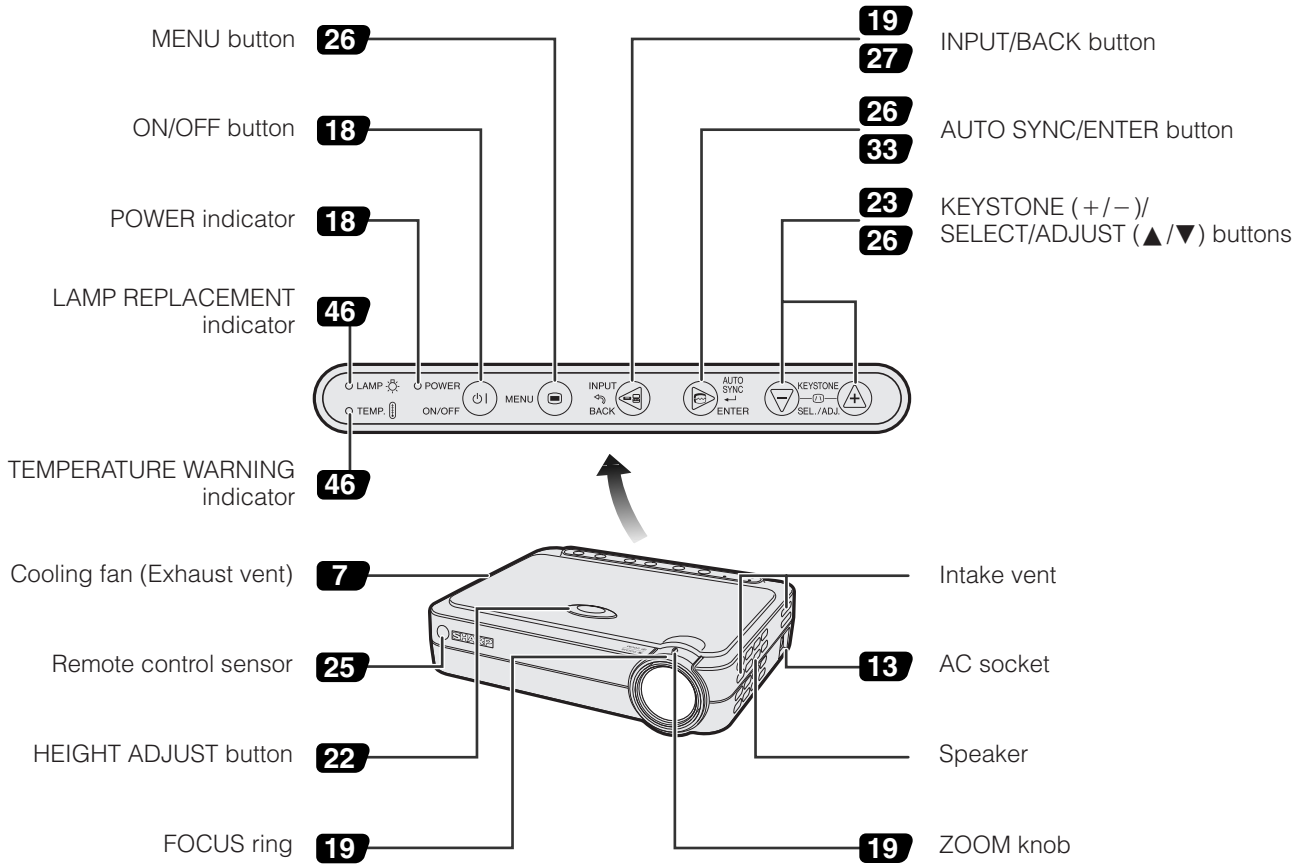

### Side and Rear View

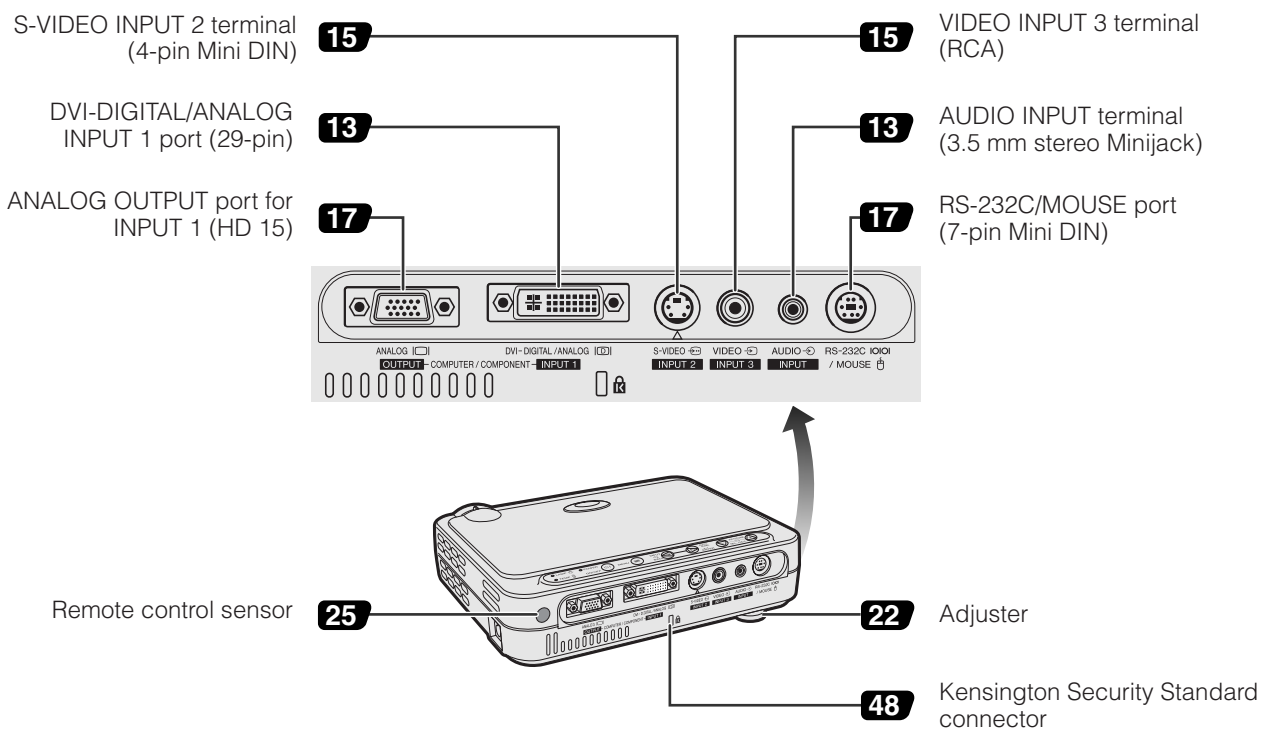



# Remote Control

## Front View

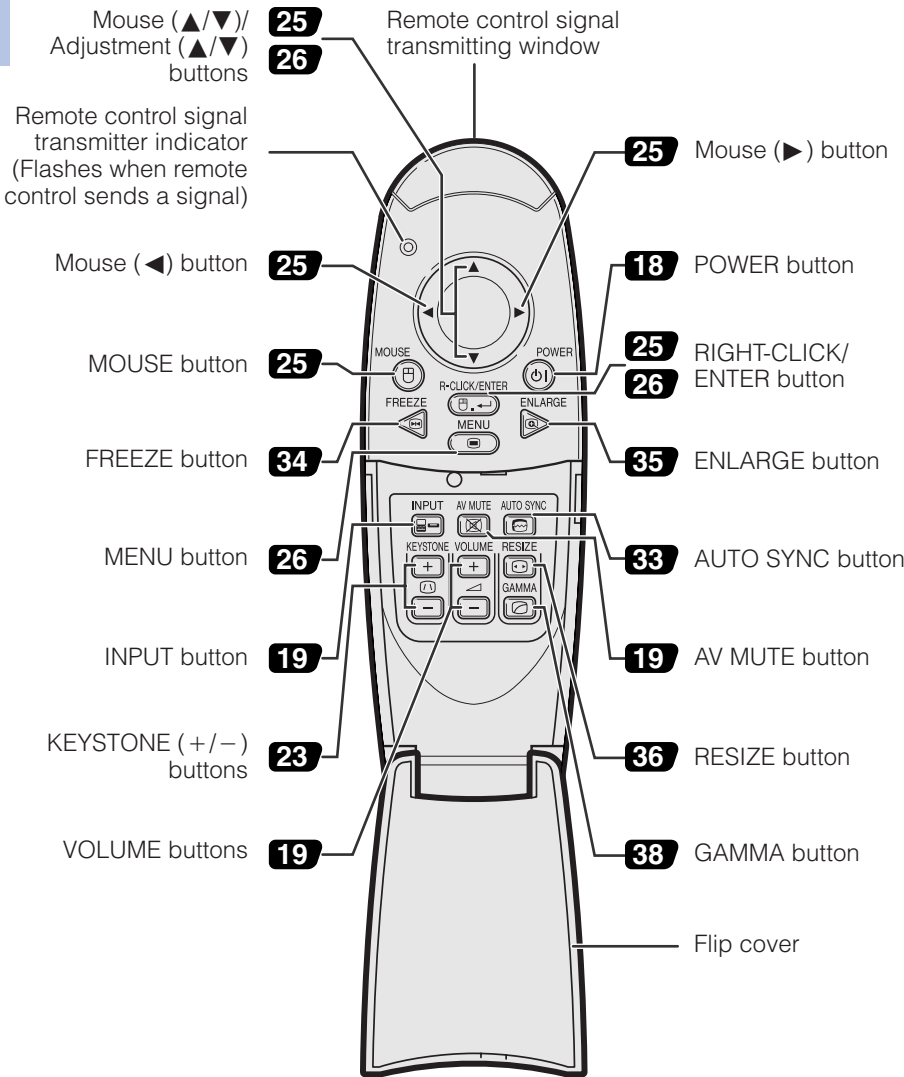

## Rear View

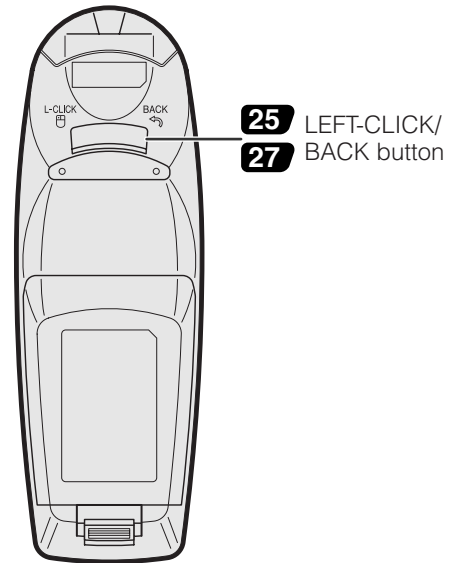

## Opening the Flip Cover

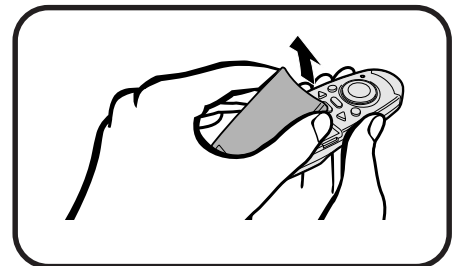

## Inserting the Batteries

<p><b>1</b> Press the tab and lift open the battery cover in the direction of the arrow.</p>	<p><b>2</b> Insert two AAA size batteries, making sure their polarities match the + and - marks inside the battery compartment.</p>	<p><b>3</b> Insert the tabs on the end of the battery cover into their slots and press the cover into position.</p>

### NOTE

- If the remote control gets wet, wipe it dry immediately.
- Avoid excessive heat and humidity.
- If you will not be using the remote control for a long time, remove the batteries.
- Do not mix new and old or different types of batteries.
- There are operations that can only be carried out by remote control. Handle the remote control carefully.



# Setup & Connections

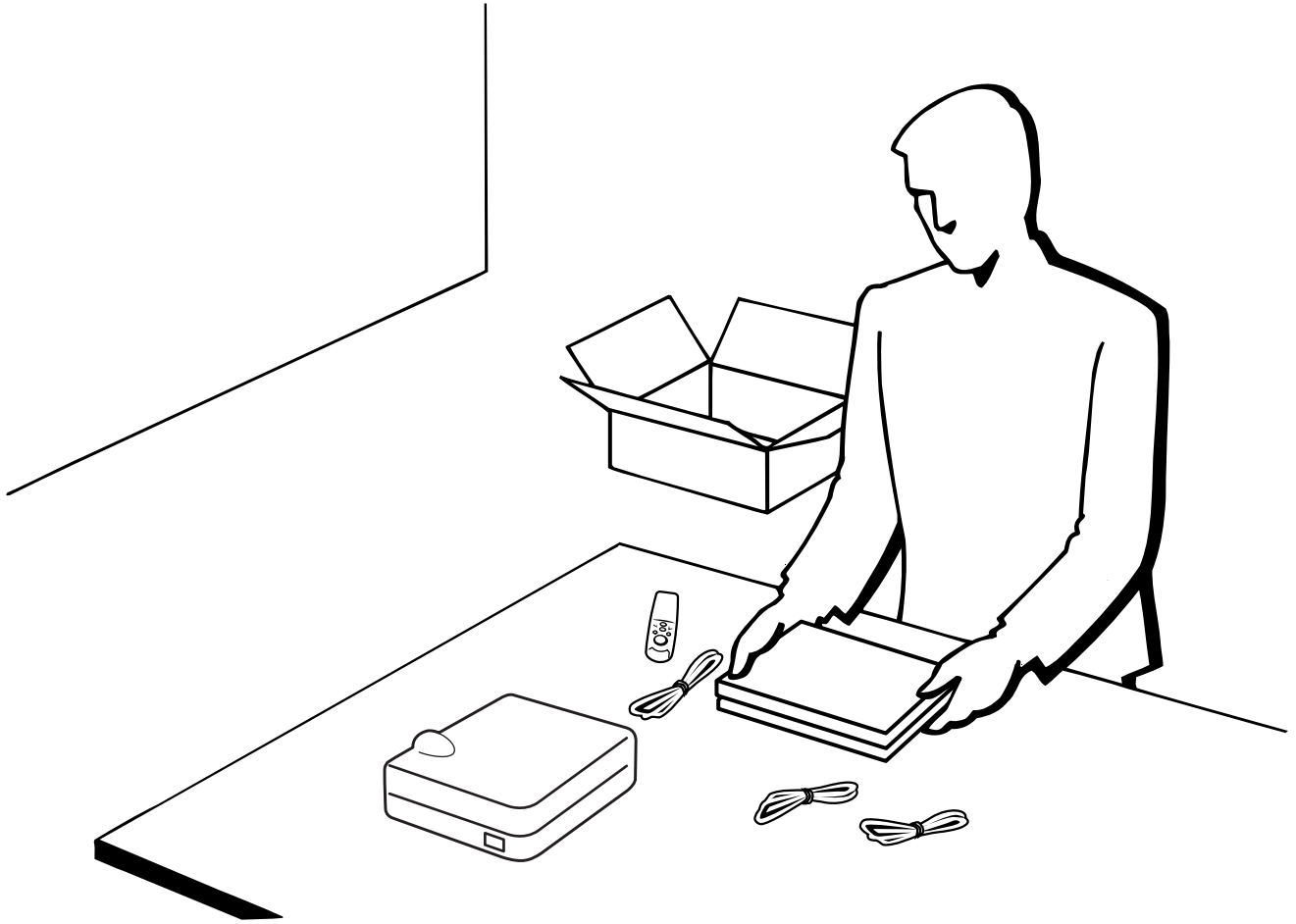



# Supplied Accessories

## Supplied Accessories



Remote control  
9HJ7583104001



Two AAA size batteries  
9HJ4683101001

Power cord

(1)

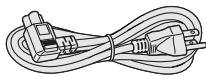

For U.S., Canada etc.  
9HJ4283114001

(2)

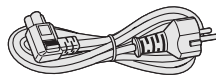

For Europe, except U.K.  
9HJ4283116001

(3)

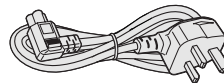

For U.K., Hong Kong  
and Singapore  
9HJ4283117001

(4)

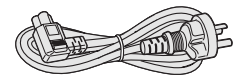

For Australia, New  
Zealand and Oceania  
9HJ4283118001

### NOTE

- Depending on the region, projectors only ship with one power cord (See above). Use the power cord that corresponds to the wall outlet in your country.

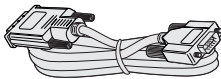

DVI-Analog to VGA cable  
9HJ4283119001

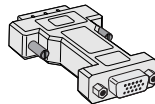

DVI-Analog to VGA adaptor  
9HJ4283124001

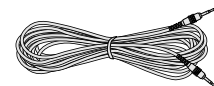

PC audio cable  
9HJ4283120001

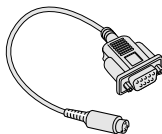

DIN-D-sub RS-232C cable  
9HJ4283123001

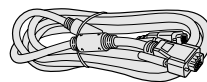

Computer RGB cable  
9HJ4283111001

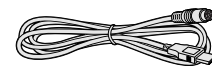

USB mouse control cable  
9HJ4283122001

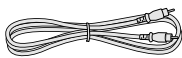

Video cable  
9HJ4283112001

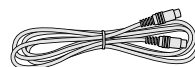

S-video cable  
9HJ4283113001

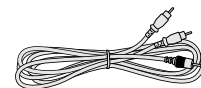

AV audio cable  
9HJ4283121001

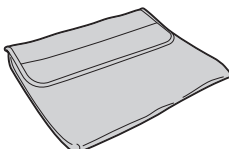

Soft carrying pouch  
9HJ5383101001

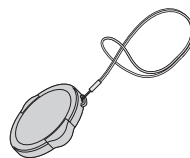

Lenscap with strap  
9HJ7083117001

CD-ROM  
9HJ3683104001

Projector operation manual  
9HJ3683107001

Projector quick reference guide  
9HJ3683110001

## Optional Cables

- DVI digital cable (9'10", 3.0 m)  
AN-C3DVU
- HD-15/RCA cable (9'10", 3.0 m)  
AN-C3CP
- RS-232C cable (32'10", 10.0 m)  
AN-C10RS





# Connecting the Projector

## Connecting the Power Cord

Plug the supplied power cord into the AC socket on the side of the projector.

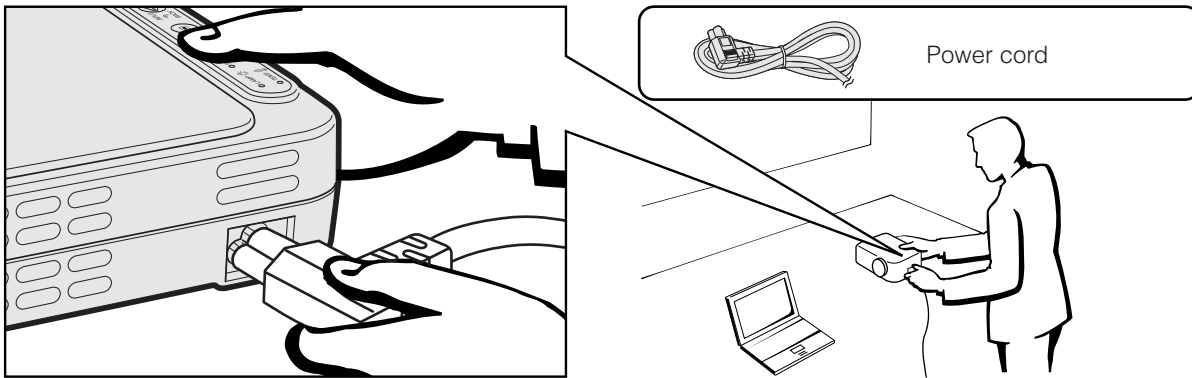

### CAUTION

- Make sure you connect the power cord firmly into the AC socket.

## Connecting the Projector to a Computer

You can connect your projector to a computer for projection of full color computer images.

### Connecting a computer to the projector using the DVI digital cable—Digital connection instructions

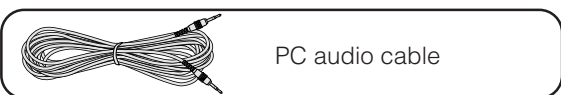
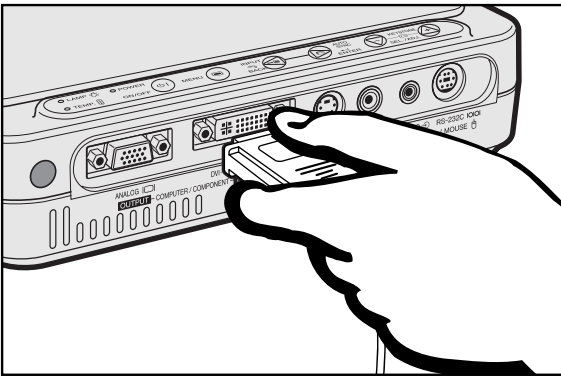

- ① Connect one end of the DVI digital cable (sold separately) to the DVI-DIGITAL/ANALOG INPUT 1 port on the projector.
- ② Connect the other end to the Monitor output port (DVI) on the computer. Secure the connectors by tightening the thumb screws.
- ③ To use the built-in audio system, connect one end of the supplied PC audio cable to the AUDIO INPUT terminal on the projector.
- ④ Connect the other end to the audio output terminal on the computer.

### Projecting the image

When connecting with this method, press **INPUT** on the remote control or the projector and select the input signal type to INPUT 1 DVI (Digital).



### CAUTION

- Before connecting, be sure to turn both the projector and the computer off. After making all connections, turn the projector on first. The computer should always be turned on last.

### NOTE

- Please read the computer's operation manual carefully.
- Refer to page 53 "Computer Compatibility Chart" for a list of computer signals compatible with the projector. Use with computer signals other than those listed may cause some of the functions not to work.
- This DVI port is DVI version 1.0 compatible. Therefore when the signal is input from copy guard system compatible (DVI version 2.0) equipment, no signal will be received.

### Projector

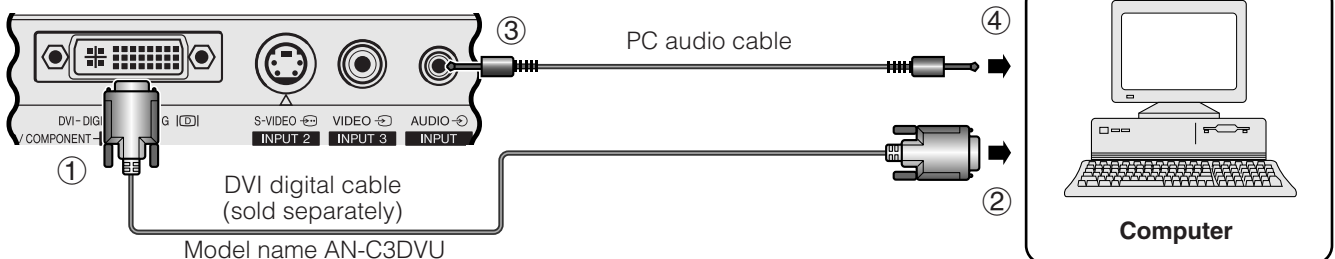



## Connecting the Projector

### Connecting a computer to the projector using the DVI-Analog to VGA adaptor or the DVI-Analog to VGA cable—Analog connection instructions

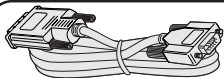
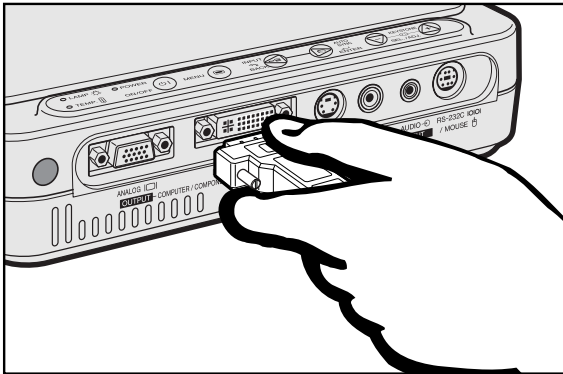

DVI-Analog to VGA cable

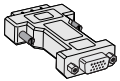

DVI-Analog to VGA adaptor

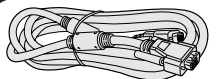

Computer RGB cable



PC audio cable

- 1 Connect one end of the supplied computer RGB cable using the supplied DVI-Analog to VGA adaptor to the DVI-DIGITAL/ANALOG INPUT 1 port on the projector, or connect the DVI side of the supplied DVI-Analog to VGA cable to the DVI-DIGITAL/ANALOG INPUT 1 port on the projector.
- 2 Connect the other end of the computer RGB cable or the VGA side of the DVI-Analog to VGA cable to the computer. Secure the connectors by tightening the thumb screws.
- 3 To use the built-in audio system, connect one end of the supplied PC audio cable to the AUDIO INPUT terminal on the projector.
- 4 Connect the other end to the audio output terminal on the computer.

#### Projecting the image

When connecting with this method, press **INPUT** on the remote control or the projector and select the input signal type to INPUT 1 Computer/Analog RGB.



#### CAUTION

- Before connecting, be sure to turn both the projector and the computer off. After making all connections, turn the projector on first. The computer should always be turned on last.

#### NOTE

- Please read the computer's operation manual carefully.
- Refer to page 53 "Computer Compatibility Chart" for a list of computer signals compatible with the projector. Use with computer signals other than those listed may cause some of the functions not to work.
- A Macintosh adaptor may be required for use with some Macintosh computers. Contact your nearest Sharp Authorized Projector Dealer or Service Center.

#### Projector

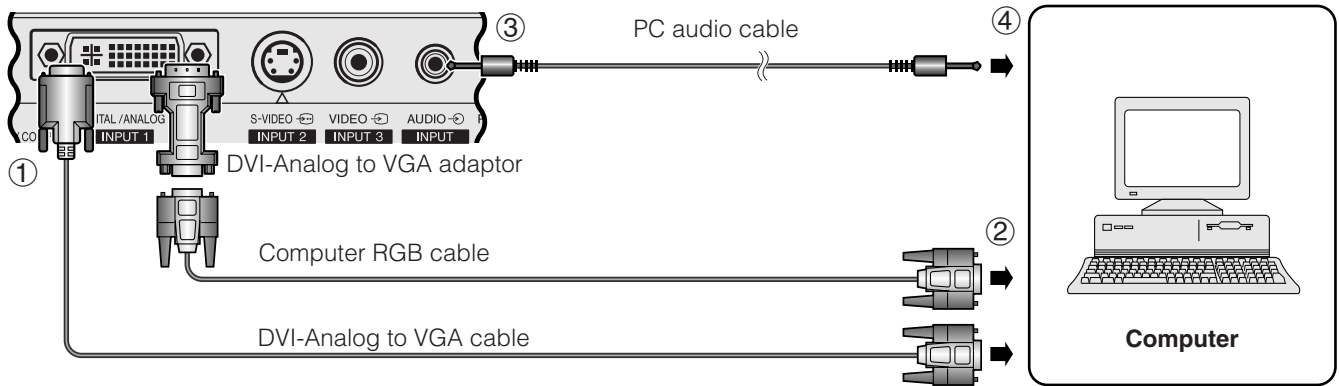

#### Connecting other compatible computers

When connecting the projector to a compatible computer other than an IBM-PC (VGA/SVGA/XGA/SXGA) or Macintosh (i.e. Workstation), a separate cable may be needed. Please contact your dealer for more information.

#### NOTE

- Connecting computers other than the recommended types may result in damage to the projector, the computer, or both.

#### "Plug and Play" function

- This projector is compatible with VESA-standard DDC 1/DDC 2B. The projector and a VESA DDC compatible computer will communicate their setting requirements, allowing for quick and easy setup.
- Before using the "Plug and Play" function, be sure to turn on the projector first and the connected computer last.

#### NOTE

- The DDC, Plug and Play function of this projector operates only when used in conjunction with a VESA DDC compatible computer.



## Connecting the Projector

### Connecting the Projector to Video Equipment

You can connect your projector to a VCR, laser disc player and other audiovisual equipment.

#### CAUTION

- Always turn off the projector while connecting to audiovisual equipment, in order to protect both the projector and the equipment being connected.

#### Connecting a video source (VCR or laser disc player) using the standard video input

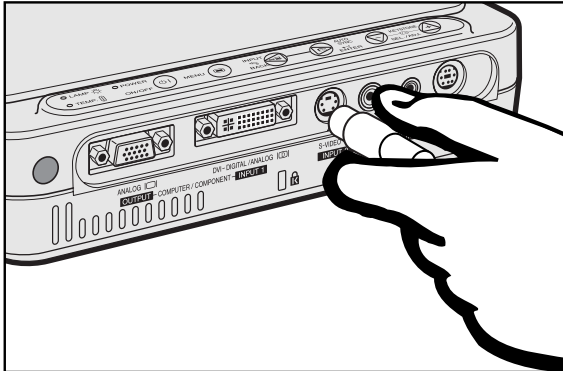

S-video cable

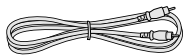

Video cable

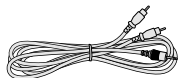

AV audio cable

- Connect the supplied S-video cable to the S-VIDEO INPUT 2 terminal on the projector and the S-video output terminal on the video source, or connect the supplied video cable to the VIDEO INPUT 3 terminal on the projector and the video output terminal on the video source.
- To use the built-in audio system, connect the supplied AV audio cable to the AUDIO INPUT terminal on the projector and the audio output terminals on the video source.

The S-VIDEO INPUT 2 terminal uses a video signal system in which the picture is separated into a color and a luminance signal to realize a higher-quality image.

#### Projecting the image

- When connecting to the S-VIDEO INPUT 2 terminal on the projector, press **INPUT** on the remote control or the projector and select the input signal type to INPUT 2 S-VIDEO.
- When connecting to the VIDEO INPUT 3 terminal on the projector, press **INPUT** on the remote control or the projector and select the input signal type to INPUT 3 VIDEO.



#### NOTE

- For higher quality video, you may use the S-VIDEO INPUT 2 terminal on the projector.
- If your video equipment does not have an S-video output terminal, use the composite video output terminal.

#### Projector

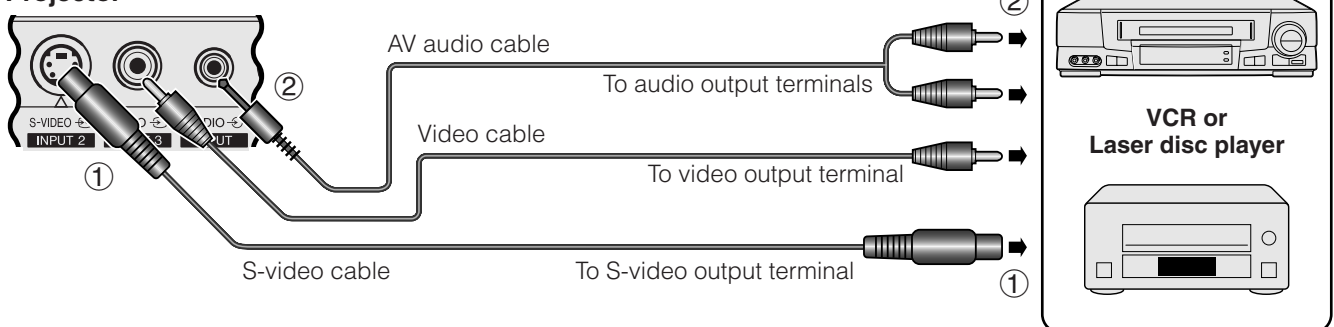



## Connecting the Projector

### Connecting a video source (DTV\* decoder or DVD player) using the DVI-DIGITAL/ANALOG INPUT 1 port

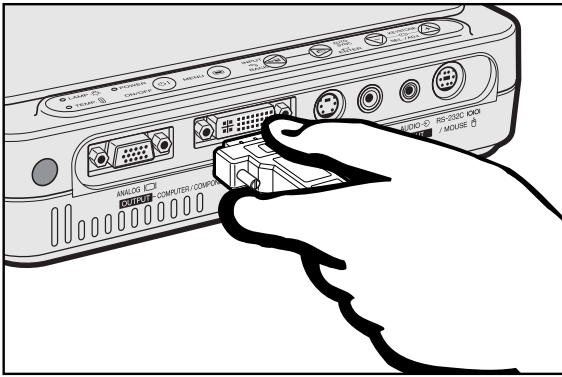

- ① Connect one end of the supplied DVI-Analog to VGA adaptor to the DVI-DIGITAL/ANALOG INPUT 1 port on the projector.
- ② Connect the other end of the DVI-Analog to VGA adaptor to the video source using the HD-15/RCA cable (sold separately).
- ③ To use the built-in audio system, connect one end of the supplied AV audio cable to the AUDIO INPUT terminal on the projector.
- ④ Connect the other end to the audio output terminal on the video source.

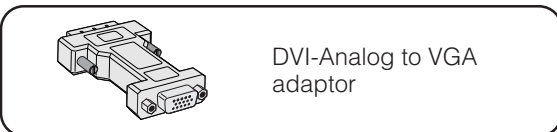

DVI-Analog to VGA adaptor

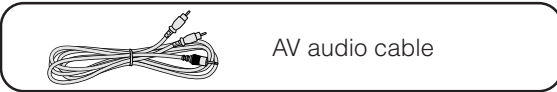

AV audio cable

#### Projecting the image

- When connecting the DTV decoder or DVD player to the DVI-DIGITAL/ANALOG INPUT 1 port on the projector, press **INPUT** on the remote control or the projector and select the input signal type to INPUT 1 COMPONENT.



#### NOTE

- The image quality may become lower depending on DTV signal compatibility.
- The projector can only accept 480i signals.

#### Projector

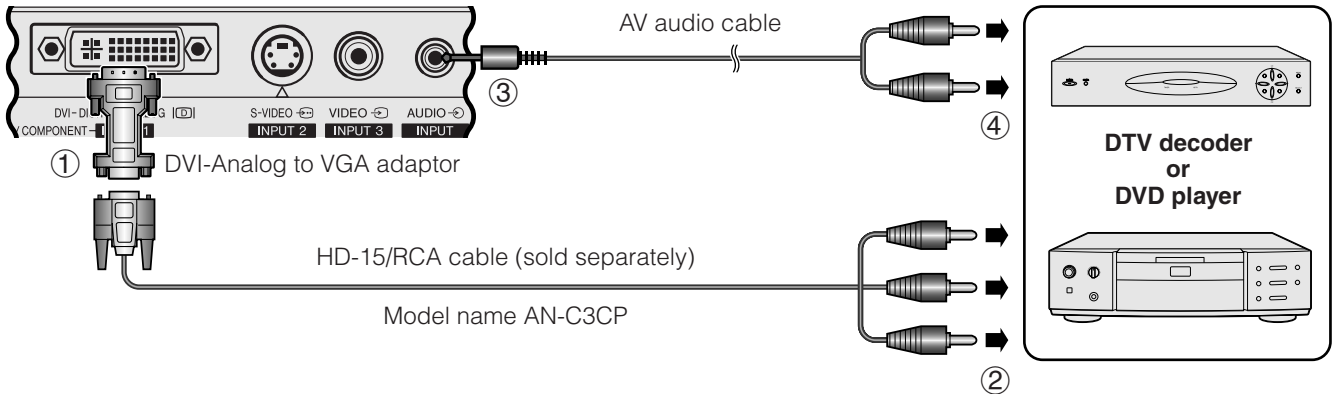

\*DTV is the umbrella term used to describe the new digital television system in the United States.



## Connecting the Projector to a Monitor

When the ANALOG OUTPUT port on the projector is connected to a monitor with RGB input, the computer can be used to display the output image to the projector and the monitor simultaneously. Use the supplied computer RGB cable to connect them.

- 1 Connect one end of the supplied computer RGB cable to the ANALOG OUTPUT port on the projector.
- 2 Connect the other end to the RGB input port on the monitor.

### NOTE

- The analog output is deactivated when the projector is in standby mode.
- An additional RGB cable may be necessary to connect the projector to an external monitor if the supplied cable is utilized for projector data input.

### Projector

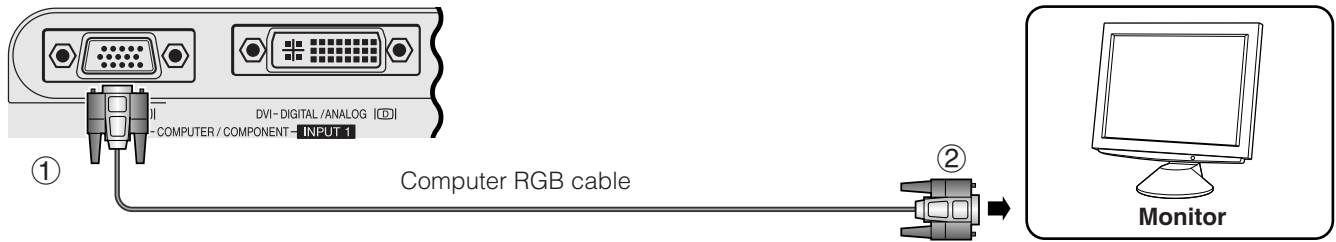

## Connecting to RS-232C/MOUSE Port

When the RS-232C/MOUSE port on the projector is connected to a computer with an RS-232C cable (null modem, cross type, sold separately), the computer can be used to control the projector and check the status of the projector. See page 52 for details.

	DVI-Analog to VGA cable
	DVI-Analog to VGA adaptor
	Computer RGB cable
	DIN-D-sub RS-232C cable

- 1 Connect the projector and computer in advance, as described on page 13 or 14.
- 2 Connect the supplied DIN-D-sub RS-232C cable to the RS-232C/MOUSE port on the projector.
- 3 Connect an RS-232C cable (null modem, cross type, sold separately) to the other end of DIN-D-sub RS-232C cable and to the serial port on the computer.

### CAUTION

- Do not connect or disconnect an RS-232C cable to or from the computer while it is on. This may damage your computer.
- When you turn off the power, be sure to turn the projector off first, and then turn the connected computer off.

### NOTE

- The wireless mouse or RS-232C function may not operate if your computer port is not correctly set up. Please refer to the operation manual of the computer for details on setting up/installing the correct mouse driver.
- A Macintosh adaptor may be required for use with some Macintosh computers. Contact your nearest Sharp Authorized Projector Dealer or Service Center.

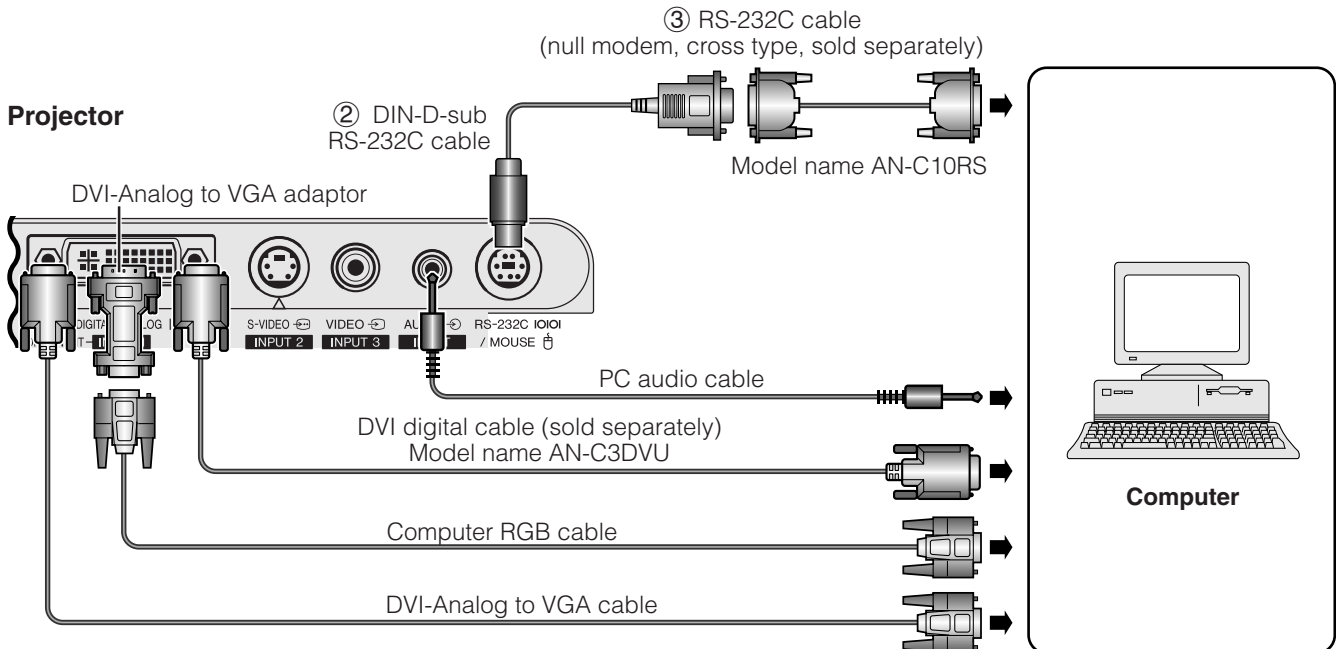



# Operation

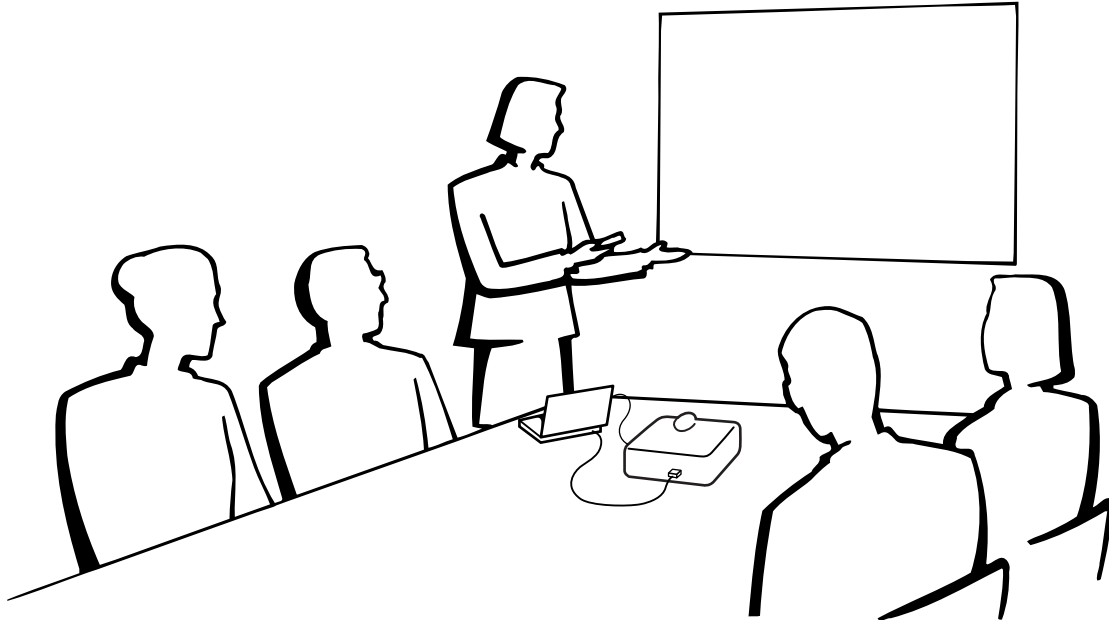

## Basic Operations

### Maintenance indicators



- ① Make the necessary connections before proceeding. Connect the power cord to a wall outlet. The **POWER** indicator illuminates red and the projector enters standby mode.

### Projector

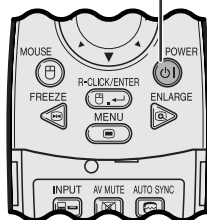
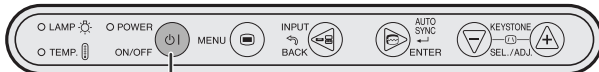

### Remote control

- ② Press **ON/OFF** on the projector or **POWER** on the remote control to turn on the power.

### NOTE

- The flashing green **LAMP REPLACEMENT** indicator shows that the lamp is warming up. Wait until the indicator stops flashing before operating the projector.
- The power can not be turned off for one minute after the initial warm-up sequence has begun.
- After the projector is unpacked and turned on for the first time, a slight odor may be emitted from the exhaust vent. This odor will soon disappear with use.

### Maintenance indicators



When the power is on, the **LAMP REPLACEMENT** indicator lights indicating the status of the lamp.

**Green:** Lamp is ready.  
**Flashing green:** Warming up.  
**Red:** Change the lamp.





## Basic Operations

### Zooming/Focusing

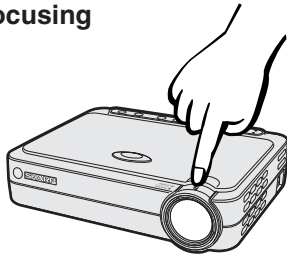

- Rotate the ZOOM knob. The image can be adjusted to the desired size within the zoom range.
- Rotate the FOCUS ring until the image on the screen becomes clear.

### Projector

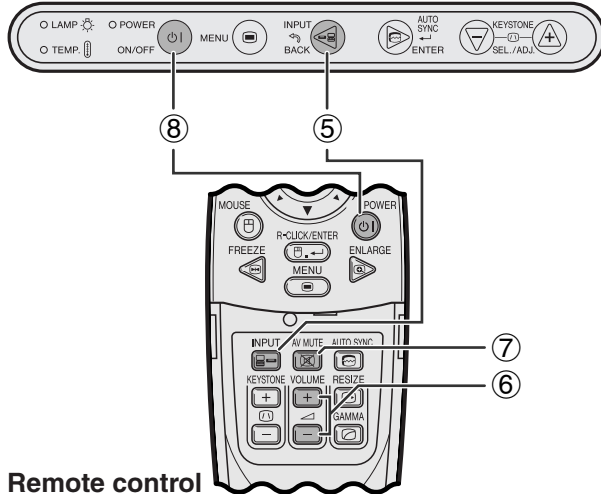

### Remote control

- Press **INPUT** to select the desired input mode. Press **INPUT** again to change the mode.

#### NOTE

- When the selected input signal is being received, "Adjusting The Image" will be displayed.
- When no signal is being received, "NO SIGNAL" will be displayed. When a signal that the projector is not preset to receive is being received, "NOT REG." will be displayed.
- You can display all input modes one by one when "Auto Source" is set to "OFF".

- Press **VOLUME** on the remote control to adjust the volume.

- Press **AV MUTE** on the remote control to temporarily turn off the picture and the sound. Press **AV MUTE** again to turn the picture and the sound back on.

- Press **ON/OFF** on the projector or **POWER** on the remote control, and then press **ON/OFF** or **POWER** again while the message is displayed to turn off the power.

#### NOTE

- If you accidentally pressed **ON/OFF** or **POWER** and do not want to turn off the power, wait until the power off screen disappears.
- When **ON/OFF** or **POWER** is pressed twice, the POWER indicator illuminates red and the cooling fan will run for about 90 seconds. The projector will then enter standby mode.
- Wait until the cooling fan stops before disconnecting the power cord.
- The power can be turned on again by pressing **ON/OFF** or **POWER**. When the power is turned on, the POWER indicator and the LAMP REPLACEMENT indicator light green.

### EXAMPLE

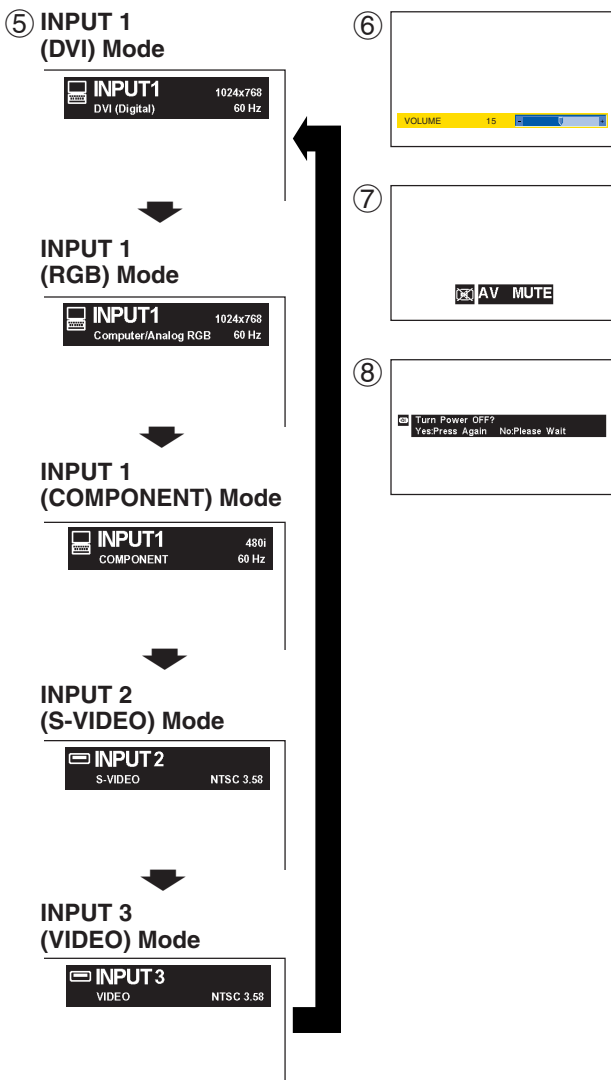



# Setting up the Screen

Position the projector perpendicular to the screen with all feet flat and level to achieve an optimal image. Move the projector forward or backward if the edges of the image are distorted.

## NOTE

- The projector lens should be centered in the middle of the screen. If the lens center is not perpendicular to the screen, the image will be distorted, making viewing difficult.
- Position the screen so that it is not in direct sunlight or room light. Light falling directly onto the screen washes out colors, making viewing difficult. Close the curtains and dim the lights when setting up the screen in a sunny or bright room.
- A polarizing screen cannot be used with this projector.

## Standard Setup (Front Projection)

Place the projector at the required distance from the screen according to the desired picture size. (See the table below.)

### PG-M15X

#### Throw distance ratio

$x$  : Picture size (Diag.) (inches)  
 $L_1$  : Maximum projection distance (feet)

$L_2$  : Minimum projection distance (feet)  
 $H$  : Distance from the lens center to the bottom of the image (inches)

### NORMAL Mode (4:3)

Picture size			Projection distance ( $L$ )		Distance from the lens center to the bottom of the image ( $H$ )
Diag. ( $x$ )	Width	Height	Maximum ( $L_1$ )	Minimum ( $L_2$ )	
250"	200"	150"	40' 0" (12.2 m)*1	33' 4" (10.2 m)*2	- 17 1/4" (- 43.2 cm)
200"	160"	120"	32' 0" (9.8 m)	26' 8" (8.1 m)	- 13 3/4" (- 34.6 cm)
150"	120"	90"	24' 0" (7.3 m)	20' 0" (6.1 m)	- 10 1/4" (- 25.9 cm)
100"	80"	60"	16' 0" (4.9 m)	13' 4" (4.1 m)	- 6 5/8" (- 17.3 cm)
84"	67"	50"	13' 5" (4.1 m)	11' 2" (3.4 m)	- 5 4/8" (- 14.5 cm)
72"	58"	43"	11' 6" (3.5 m)	9' 7" (2.9 m)	- 4 5/8" (- 12.4 cm)
60"	48"	36"	9' 7" (2.9 m)	8' 0" (2.4 m)	- 4 5/8" (- 10.4 cm)
40"	32"	24"	6' 5" (2.0 m)	5' 4" (1.6 m)	- 2 4/8" (- 6.9 cm)

The formula for picture size and projection distance

$$L_1 \text{ (feet)} = 0.04875x \times 3.281$$

$$L_2 \text{ (feet)} = 0.04064x \times 3.281$$

$$H \text{ (inches)} = -0.06804x$$

### STRETCH Mode (16:9)

Picture size			Projection distance ( $L$ )		Distance from the lens center to the bottom of the image ( $H$ )
Diag. ( $x$ )	Width	Height	Maximum ( $L_1$ )	Minimum ( $L_2$ )	
225"	196"	110"	39' 2" (12.0 m)*3	32' 8" (10.0 m)*4	- 35 1/4" (- 89.1 cm)
200"	174"	98"	34' 10" (10.6 m)*5	29' 1" (8.9 m)	- 31 1/4" (- 79.2 cm)
150"	131"	74"	26' 3" (8.0 m)	21' 9" (6.6 m)	- 23 2/4" (- 59.4 cm)
133"	116"	65"	23' 2" (7.1 m)	19' 4" (5.9 m)	- 20 4/8" (- 52.6 cm)
106"	92"	52"	18' 6" (5.6 m)	15' 5" (4.7 m)	- 16 3/4" (- 42.0 cm)
100"	87"	49"	17' 5" (5.3 m)	14' 6" (4.4 m)	- 15 3/4" (- 39.6 cm)
92"	80"	45"	16' 0" (4.9 m)	13' 4" (4.1 m)	- 14 2/4" (- 36.4 cm)
84"	73"	41"	14' 8" (4.5 m)	12' 2" (3.7 m)	- 13 9/4" (- 33.2 cm)
72"	63"	35"	12' 7" (3.8 m)	10' 6" (3.2 m)	- 11 1/4" (- 28.5 cm)
60"	52"	29"	10' 5" (3.2 m)	8' 9" (2.7 m)	- 9 2/4" (- 23.7 cm)
40"	35"	20"	7' 0" (2.1 m)	5' 10" (1.8 m)	- 6 1/4" (- 15.8 cm)

The formula for picture size and projection distance

$$L_1 \text{ (feet)} = 0.05315x \times 3.281$$

$$L_2 \text{ (feet)} = 0.04428x \times 3.281$$

$$H \text{ (inches)} = -0.1558x$$

### BORDER Mode (4:3)

Picture size			Projection distance ( $L$ )		Distance from the lens center to the bottom of the image ( $H$ )
Diag. ( $x$ )	Width	Height	Maximum ( $L_1$ )	Minimum ( $L_2$ )	
180"	144"	108"	38' 5" (11.7 m)*6	32' 0" (9.8 m)	- 34 2/4" (- 87.2 cm)
150"	120"	90"	32' 0" (9.8 m)	26' 8" (8.1 m)	- 28 3/4" (- 72.7 cm)
100"	80"	60"	21' 4" (6.5 m)	17' 9" (5.4 m)	- 19 5/4" (- 48.4 cm)
84"	67"	50"	17' 11" (5.5 m)	14' 11" (4.6 m)	- 16 1/4" (- 40.7 cm)
72"	58"	43"	15' 4" (4.7 m)	12' 10" (3.9 m)	- 13 4/4" (- 34.9 cm)
60"	48"	36"	12' 10" (3.9 m)	10' 8" (3.3 m)	- 11 2/4" (- 29.1 cm)
40"	32"	24"	8' 6" (2.6 m)	7' 1" (2.2 m)	- 7 4/4" (- 19.4 cm)

The formula for picture size and projection distance

$$L_1 \text{ (feet)} = 0.06504x \times 3.281$$

$$L_2 \text{ (feet)} = 0.05419x \times 3.281$$

$$H \text{ (inches)} = -0.1907x$$

## NOTE

- There is an error of  $\pm 3\%$  in the formula above.
- Values with a minus (-) sign indicate the distance of the lens center below the bottom of the screen.
- The values do not match up when applying the formula in \*1 to \*6 above. However, this is not a calculation error.
- For optimum focus, the recommended projection distance ( $L$ ) is from 3' 9" (1.15m) to 32' 10" (10.0m).





## Setting up the Screen

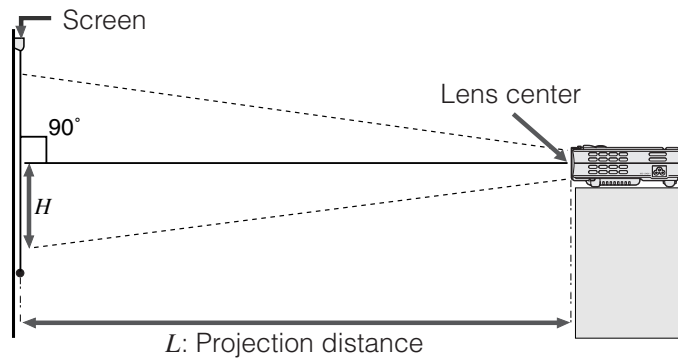

### PG-M15S Throw distance ratio

#### NORMAL Mode (4:3)

$x$  : Picture size (Diag.) (inches)  
 $L_1$ : Maximum projection distance (feet)

$L_2$ : Minimum projection distance (feet)  
 $H$ : Distance from the lens center to the bottom of the image (inches)

Picture size			Projection distance ( $L$ )		Distance from the lens center to the bottom of the image ( $H$ )
Diag. ( $x$ )	Width	Height	Maximum ( $L_1$ )	Minimum ( $L_2$ )	
250"	200"	150"	41' 8" (12.7 m)*1	35' 0" (10.7 m)*2	- 17 <sup>41</sup> / <sub>64</sub> " (- 44.8 cm)
200"	160"	120"	33' 4" (10.2 m)*3	28' 0" (8.5 m)	- 14 <sup>7</sup> / <sub>64</sub> " (- 35.8 cm)
150"	120"	90"	25' 0" (7.6 m)	21' 0" (6.4 m)	- 10 <sup>37</sup> / <sub>64</sub> " (- 26.9 cm)
100"	80"	60"	16' 8" (5.1 m)	14' 0" (4.3 m)	- 7 <sup>4</sup> / <sub>64</sub> " (- 17.9 cm)
84"	67"	50"	14' 0" (4.3 m)	11' 9" (3.6 m)	- 5 <sup>59</sup> / <sub>64</sub> " (- 15.1 cm)
72"	58"	43"	12' 0" (3.7 m)	10' 1" (3.1 m)	- 5 <sup>9</sup> / <sub>64</sub> " (- 12.9 cm)
60"	48"	36"	10' 0" (3.0 m)	8' 5" (2.6 m)	- 4 <sup>15</sup> / <sub>64</sub> " (- 10.8 cm)
40"	32"	24"	6' 8" (2.0 m)	5' 7" (1.7 m)	- 2 <sup>53</sup> / <sub>64</sub> " (- 7.2 cm)

The formula for picture size and projection distance

$$L_1 \text{ (feet)} = 0.05080x \times 3.281$$

$$L_2 \text{ (feet)} = 0.04269x \times 3.281$$

$$H \text{ (inches)} = -0.07056x$$

#### STRETCH Mode (16:9)

Picture size			Projection distance ( $L$ )		Distance from the lens center to the bottom of the image ( $H$ )
Diag. ( $x$ )	Width	Height	Maximum ( $L_1$ )	Minimum ( $L_2$ )	
225"	196"	110"	40' 10" (12.5 m)*4	34' 4" (10.5 m)*5	- 35 <sup>43</sup> / <sub>64</sub> " (- 90.6 cm)
200"	174"	98"	36' 4" (11.1 m)*6	30' 6" (9.3 m)	- 31 <sup>47</sup> / <sub>64</sub> " (- 80.6 cm)
150"	131"	74"	27' 3" (8.3 m)	22' 11" (7.0 m)	- 23 <sup>50</sup> / <sub>64</sub> " (- 60.4 cm)
133"	116"	65"	24' 2" (7.4 m)	20' 4" (6.2 m)	- 21 <sup>7</sup> / <sub>64</sub> " (- 53.6 cm)
106"	92"	52"	19' 3" (5.9 m)	16' 2" (4.9 m)	- 16 <sup>52</sup> / <sub>64</sub> " (- 42.7 cm)
100"	87"	49"	18' 2" (5.5 m)	15' 3" (4.7 m)	- 15 <sup>55</sup> / <sub>64</sub> " (- 40.3 cm)
92"	80"	45"	16' 8" (5.1 m)	14' 0" (4.3 m)	- 14 <sup>39</sup> / <sub>64</sub> " (- 37.1 cm)
84"	73"	41"	15' 3" (4.6 m)	12' 10" (3.9 m)	- 13 <sup>20</sup> / <sub>64</sub> " (- 33.8 cm)
72"	63"	35"	13' 1" (4.0 m)	11' 0" (3.3 m)	- 11 <sup>27</sup> / <sub>64</sub> " (- 29.0 cm)
60"	52"	29"	10' 11" (3.3 m)	9' 2" (2.8 m)	- 9 <sup>34</sup> / <sub>64</sub> " (- 24.2 cm)
40"	35"	20"	7' 3" (2.2 m)	6' 1" (1.9 m)	- 6 <sup>22</sup> / <sub>64</sub> " (- 16.1 cm)

The formula for picture size and projection distance

$$L_1 \text{ (feet)} = 0.05535x \times 3.281$$

$$L_2 \text{ (feet)} = 0.04651x \times 3.281$$

$$H \text{ (inches)} = -0.1586x$$

#### BORDER Mode (4:3)

Picture size			Projection distance ( $L$ )		Distance from the lens center to the bottom of the image ( $H$ )
Diag. ( $x$ )	Width	Height	Maximum ( $L_1$ )	Minimum ( $L_2$ )	
180"	144"	108"	40' 0" (12.2 m)*7	33' 7" (10.2 m)*8	- 34 <sup>60</sup> / <sub>64</sub> " (- 88.7 cm)
150"	120"	90"	33' 4" (10.2 m)*9	28' 0" (8.5 m)	- 29 <sup>7</sup> / <sub>64</sub> " (- 73.9 cm)
100"	80"	60"	22' 3" (6.8 m)	18' 8" (5.7 m)	- 19 <sup>26</sup> / <sub>64</sub> " (- 49.3 cm)
84"	67"	50"	18' 8" (5.7 m)	15' 8" (4.8 m)	- 16 <sup>19</sup> / <sub>64</sub> " (- 41.4 cm)
72"	58"	43"	16' 0" (4.9 m)	13' 5" (4.1 m)	- 13 <sup>62</sup> / <sub>64</sub> " (- 35.5 cm)
60"	48"	36"	13' 4" (4.1 m)	11' 2" (3.4 m)	- 11 <sup>41</sup> / <sub>64</sub> " (- 29.6 cm)
40"	32"	24"	8' 11" (2.7 m)	7' 6" (2.3 m)	- 7 <sup>49</sup> / <sub>64</sub> " (- 19.7 cm)

The formula for picture size and projection distance

$$L_1 \text{ (feet)} = 0.06774x \times 3.281$$

$$L_2 \text{ (feet)} = 0.05692x \times 3.281$$

$$H \text{ (inches)} = -0.1941x$$

#### NOTE

- There is an error of  $\pm 3\%$  in the formula above.
- Values with a minus (-) sign indicate the distance of the lens center below the bottom of the screen.
- The values do not match up when applying the formula in \*1 to \*9 above. However, this is not a calculation error.
- For optimum focus, the recommended projection distance ( $L$ ) is from 3' 9" (1.15m) to 32' 10" (10.0m).





## Setting up the Screen

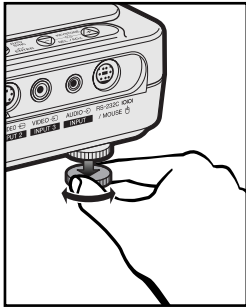
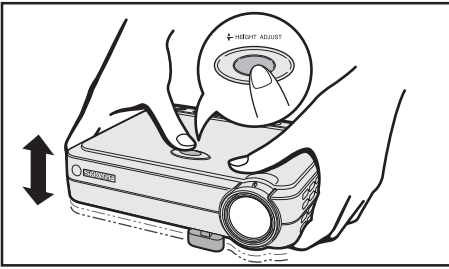

### Using the Adjustment Feet

You can adjust the height of the image by raising the projector with the foot release.

- ① Lift the projector and press **HEIGHT ADJUST**. (The adjuster comes out.)
- ② While pressing **HEIGHT ADJUST**, lower the projector to adjust the height. (Adjustable up to approximately 8° from the standard position)
- ③ Remove your finger from **HEIGHT ADJUST** at the desired angle.
- ④ Rotate the rear adjuster to adjust the projector exactly. (Adjustable up to approximately 1° from the left rear foot)

### Returning the projector to its original position

While holding the projector, press **HEIGHT ADJUST** and slowly lower the projector to its original position.

#### NOTE

- When an adjustment is made, the image may become distorted (keystoned), depending on the relative positions of the projector and the screen.

#### CAUTION

- Do not press **HEIGHT ADJUST** when the adjustment foot is extended without firmly holding the projector.
- Do not hold the lens when lifting or lowering the projector.
- When lowering the projector, be careful not to get your fingers caught between the table and the projector.

## Reversed Image Setup

### Rear projection

- Place a translucent screen between the projector and the audience.
- Use the projector's menu system to reverse the projected image. (See page 44 for use of this function.)

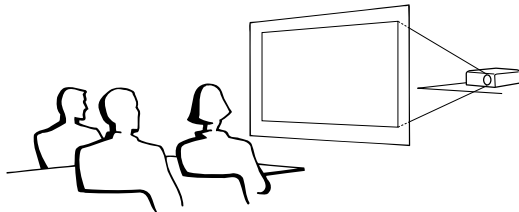

### Projection using a mirror

- When the distance between the projector and screen is not sufficient for normal rear projection, you can use a mirror to reflect the image onto the screen.
- Place a mirror (normal flat type) in front of the lens.
- Project the normal image onto the mirror.
- The image reflected from the mirror is projected onto the translucent screen.

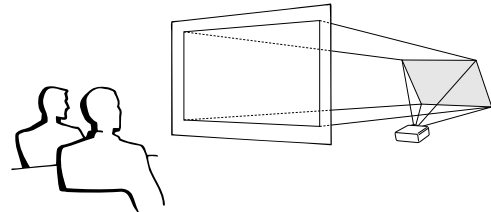

#### NOTE

- Optimal image quality can be achieved when the projector is positioned perpendicular to the screen with all feet flat and level.

#### CAUTION

- When using a mirror, be sure to carefully position both the projector and the mirror so the light does not shine into the eyes of the audience.

## Ceiling-mount Setup

- It is recommended that you use the optional Sharp ceiling-mount bracket for this installation.
- Before mounting the projector, contact your nearest Sharp Authorized Projector Dealer or Service Center to obtain the recommended ceiling-mount bracket (sold separately). (AN-PGCM85 ceiling-mount bracket and its AN-EP101A extension tube (for U.S.A.), or AN-M15T ceiling-mount bracket and its AN-TK201/AN-TK202 extension tubes (for countries other than the U.S.A.))
- When the projector is in the inverted position, use the upper edge of the screen as the base line.
- Use the projector's menu system to select the appropriate projection mode. (See page 44 for use of this function.)

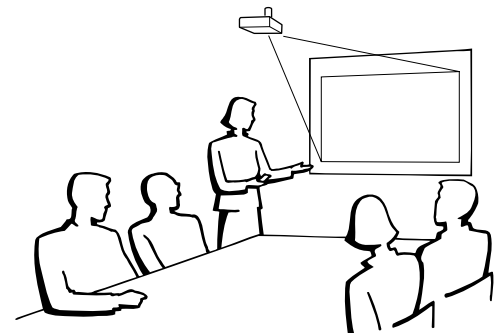



## Setting up the Screen

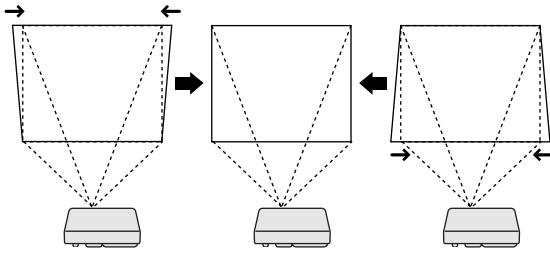

## Digital Keystone Correction

- When the image is distorted due to the projection angle, the digital keystone correction function allows you to correct it.
- The digital keystone correction can be made by pressing **KEYSTONE (+/-)**.

### Projector

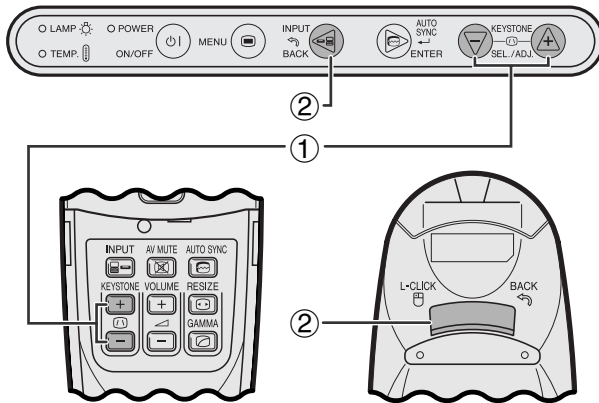

### Remote control

### Projector

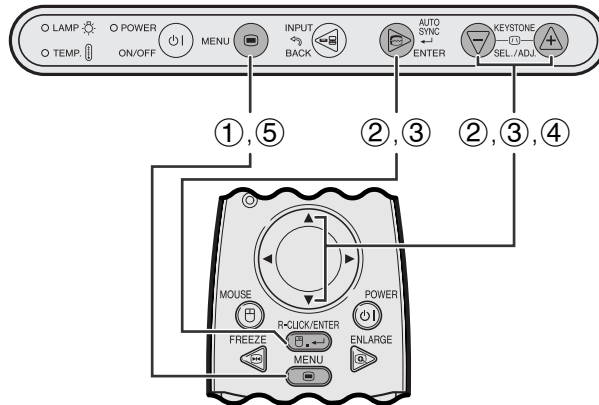

### Remote control

### (GUI) On-screen Display

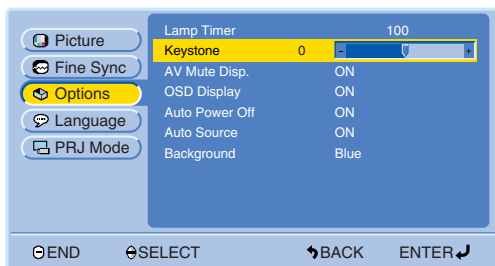

### Using the KEYSTONE buttons

- ① Press **KEYSTONE (+/-)** to adjust the setting.
- ② To reset the keystone setting, press **BACK**.

### NOTE

- Whenever "Keystone" is displayed on the screen, you can reset the setting by pressing **BACK**.

### Using the GUI menu

- ① Press **MENU**.
- ② Press **▲/▼** to select "Options", and then press **ENTER**.
- ③ Press **▲/▼** to select "Keystone", and then press **ENTER**.
- ④ Press **▲/▼** to move the **▼** mark to the desired setting.
- ⑤ To exit from the GUI, press **MENU**.

### NOTE

- Straight lines and the edges of the displayed image may appear jagged, when adjusting the keystone setting.





# Operating the **Wireless Mouse** from the Remote Control

You can use the remote control to operate the mouse of the computer image projected to the screen.

## Connecting the projector to a computer using a USB mouse control cable

### Connecting to the USB port on a PC or Macintosh

- ① Connect one end of the supplied USB mouse control cable to the RS-232C/MOUSE port on the projector.
- ② Connect the other end to the corresponding terminal on the computer.

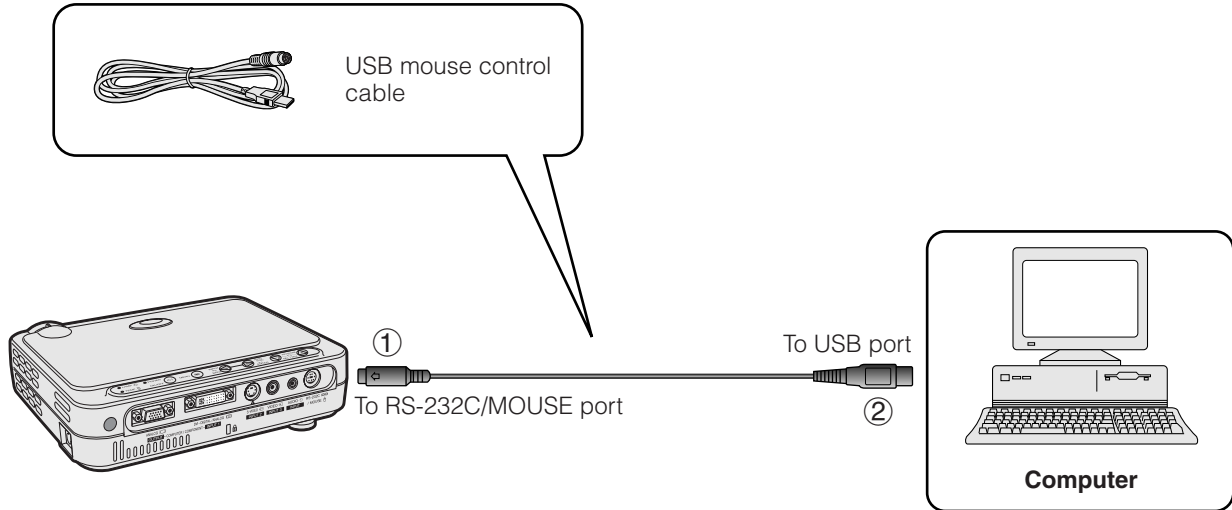

#### NOTE

- Windows 95 does not support USB mouse driver software.
- The minimum system requirements for the USB type mouse system are shown below.

#### Windows

Hardware: PC/AT compatible machine with USB port

OS: Windows 98/Windows 2000/Windows Me

#### Macintosh

Hardware: Macintosh series with USB port

OS: Mac OS 8.5 or higher

- The wireless mouse functions can be used to operate computers compatible with USB type mouse system.







## Remote Control/Wireless Mouse Positioning

- The remote control and the wireless mouse functions can be used to control the projector within the ranges shown below.
- The remote control can be used with the wireless mouse functions to control the mouse operation on the computer connected to the projector.

### NOTE

- The signal from the remote control can be reflected off a screen for easy operation. However, the effective distance of the signal may differ due to the screen material.

## Controlling the Projector or Using the Wireless Mouse Functions

### Remote control

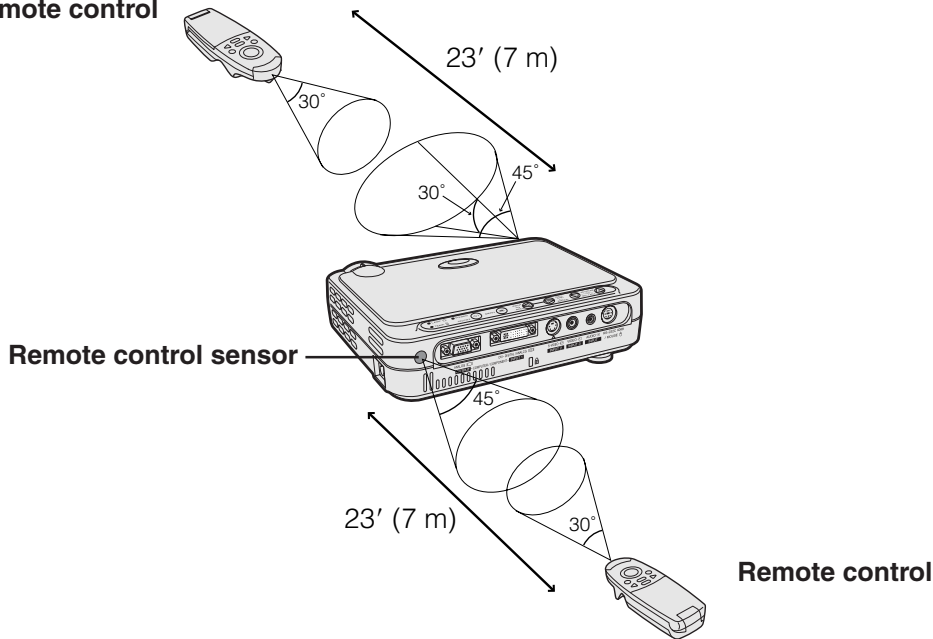

## Effective buttons in MOUSE mode

### Remote control (Front view)

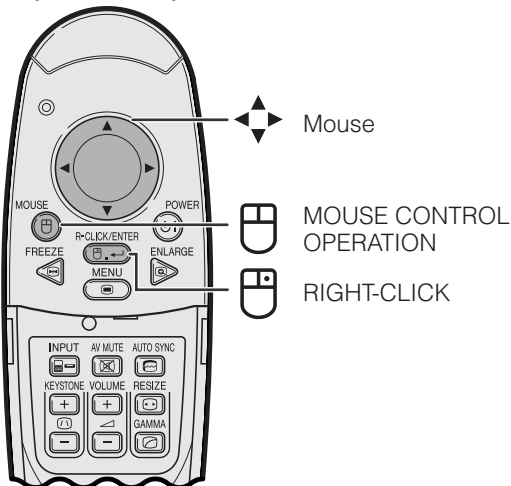

### Remote control (Rear view)

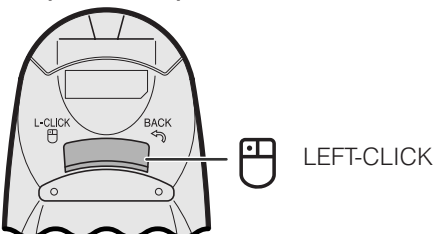

## Using as a Wireless Mouse

- When **MOUSE** is pressed, the buttons on the remote control light up and the remote control enters MOUSE mode.
- During MOUSE mode, the cursor can be used as the pointer. MOUSE mode is for about ten seconds while the buttons are lighting.
- When **MENU** or **ENLARGE** is pressed, MOUSE mode is released to the normal mode.

### NOTE

- The wireless mouse may not operate correctly if your computer is not correctly set up. Refer to the computer's operation manual for details of setting up/installing the mouse driver.
- For one-button mouse systems, use either **LEFT-CLICK** or **RIGHT-CLICK**.
- To conserve battery life, **MOUSE** stays active for approximately 10 seconds. Reactivate by pressing **MOUSE** again.





# Using the GUI (Graphical User Interface) Menu Screens

This projector has four sets of menu screens (INPUT 1 (DVI), INPUT 1 (RGB), INPUT 1 (COMPONENT) and INPUT 2 (S-VIDEO) or 3 (VIDEO)) that allow you to adjust the image and various projector settings. These menu screens can be operated from the projector or the remote control with the following buttons.

## Projector

## Remote control

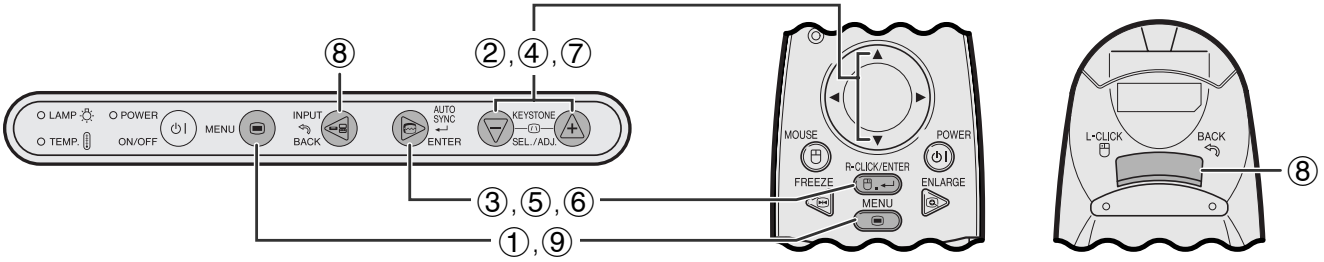

### (GUI) On-screen Display

#### INPUT 1 (DVI) or (RGB) Mode Menu Screen (Example)



#### INPUT 1 (COMPONENT), INPUT 2 (S-VIDEO) or INPUT 3 (VIDEO) Mode Menu Screen (Example)



## Basic Operation of the Menu Screen

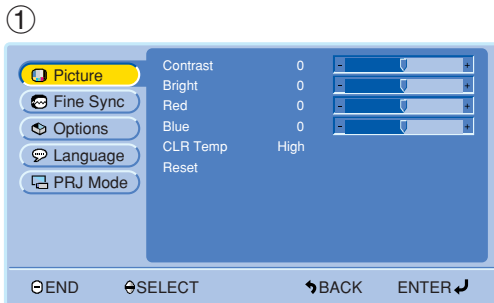

① Press **MENU** to display the main menu.

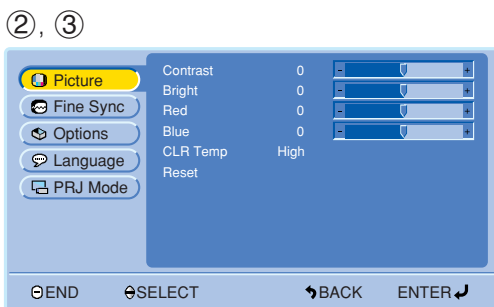

② Press **▲/▼** to select an adjustment item in the main menu.

③ Press **ENTER** to display the sub menu.



## Using the GUI (Graphical User Interface) Menu Screens

④, ⑤



④ Press ▲/▼ to select an adjustment item in the sub menu.

⑤ Press **ENTER** to activate the selected adjustment item.

⑥

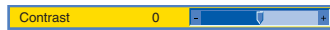

⑥ To display a single adjustment item, press **ENTER** after selecting the item. Only the menu bar and the selected adjustment item will appear.

⑦



⑦ Press ▲/▼ to adjust the item.

⑧ Press **BACK** to return to the previous screen.

⑨ Press **MENU** to exit from the GUI.

### NOTE

- For details on items on the menu screen, see the tree charts on pages 28 and 29.





## Items on the INPUT 1 (DVI) Mode Menu Bar

## Items on the INPUT 1 (RGB) Mode Menu Bar

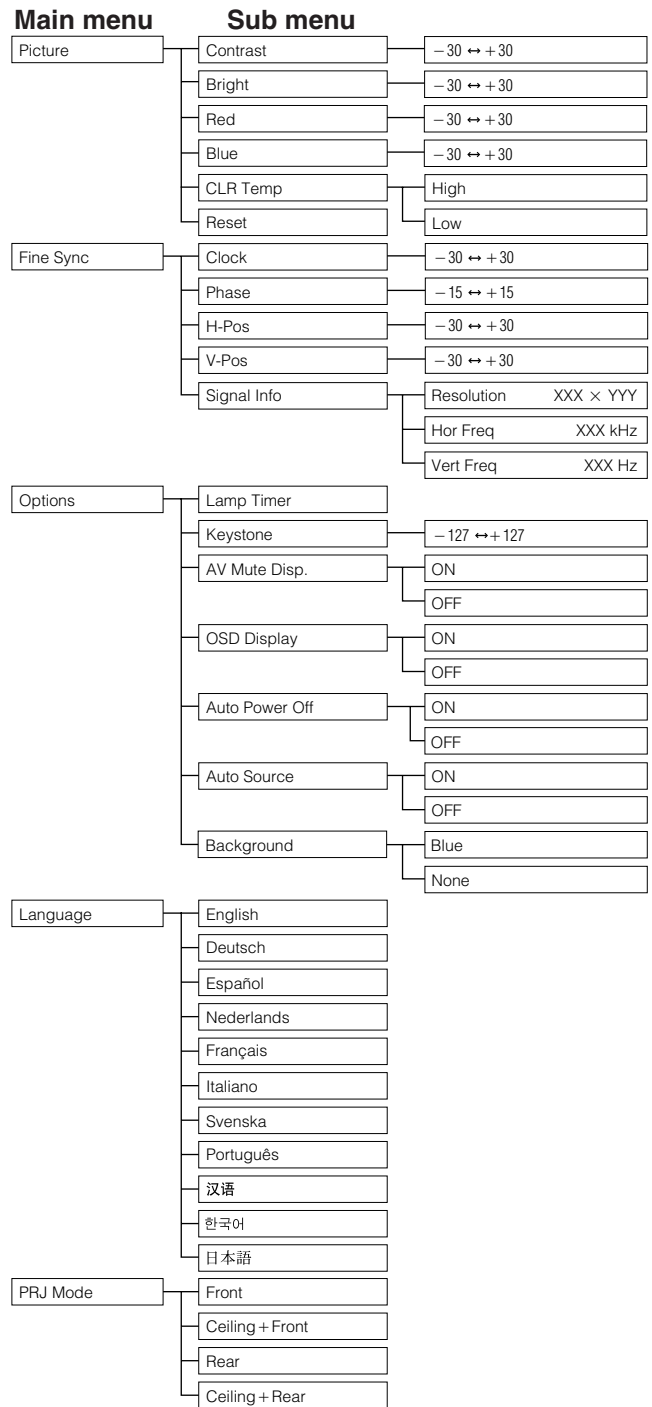
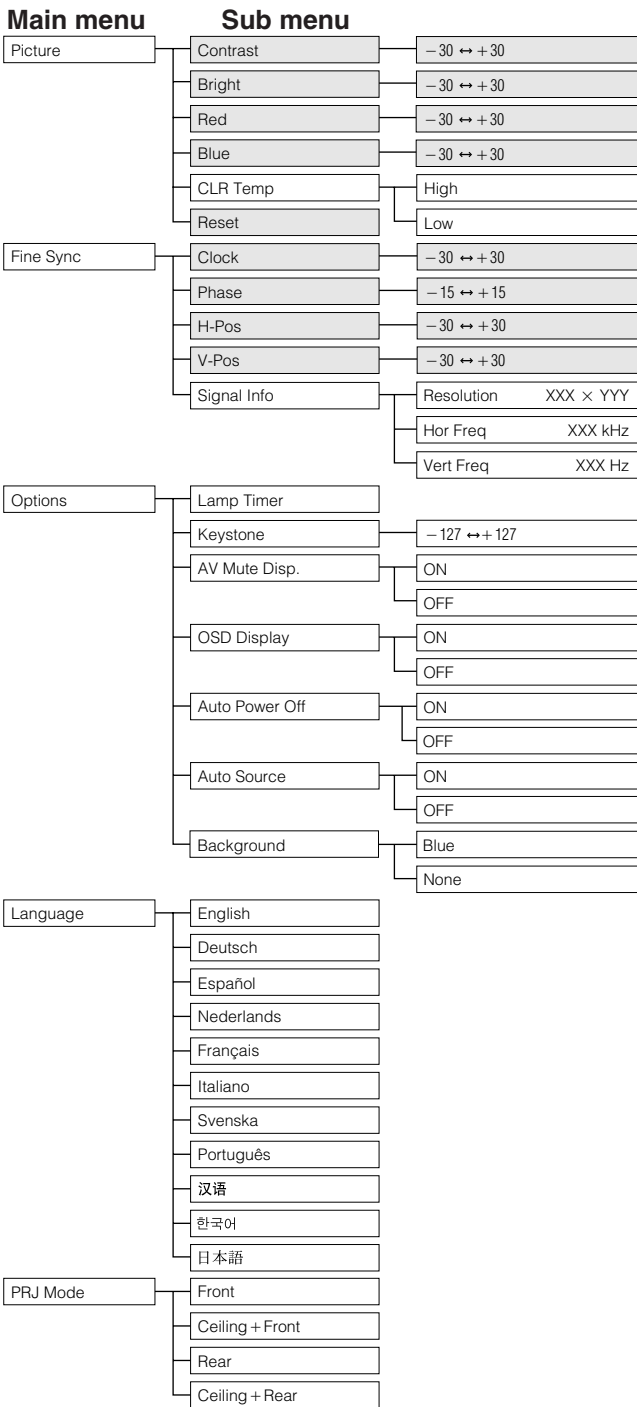

### NOTE

- The darkened items in the above chart will be displayed in gray and can not be selected.





## Items on the INPUT 1 (COMPONENT) Mode Menu Bar

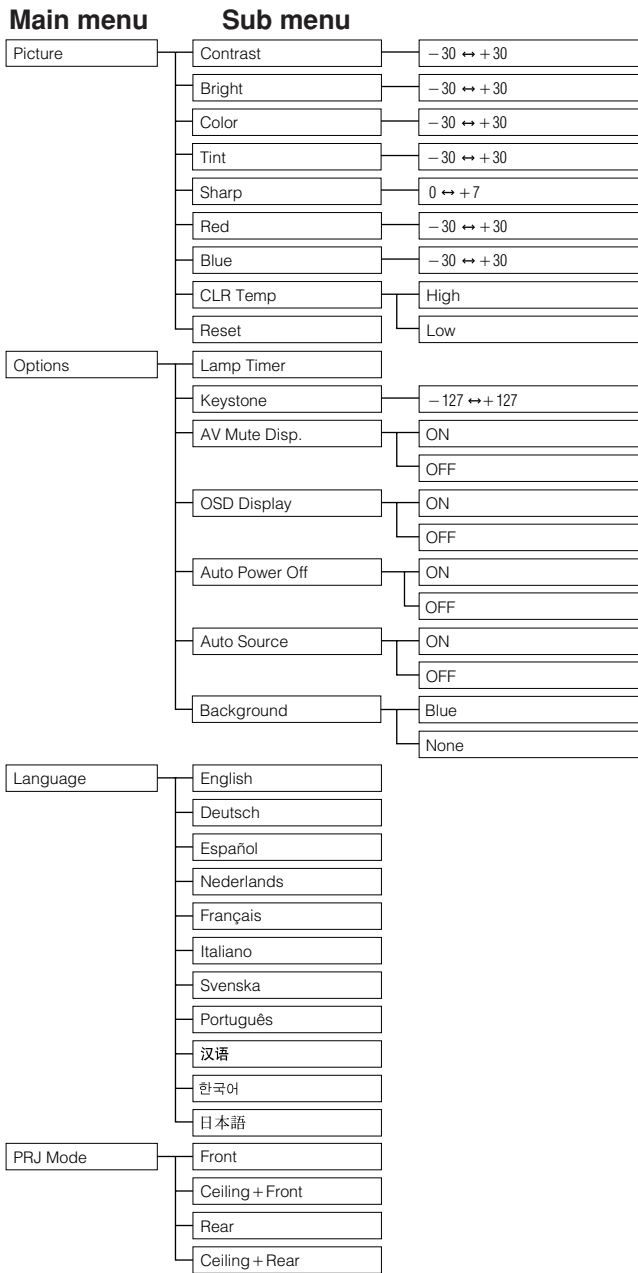

## Items on the INPUT 2 (S-VIDEO) or INPUT 3 (VIDEO) Mode Menu Bar

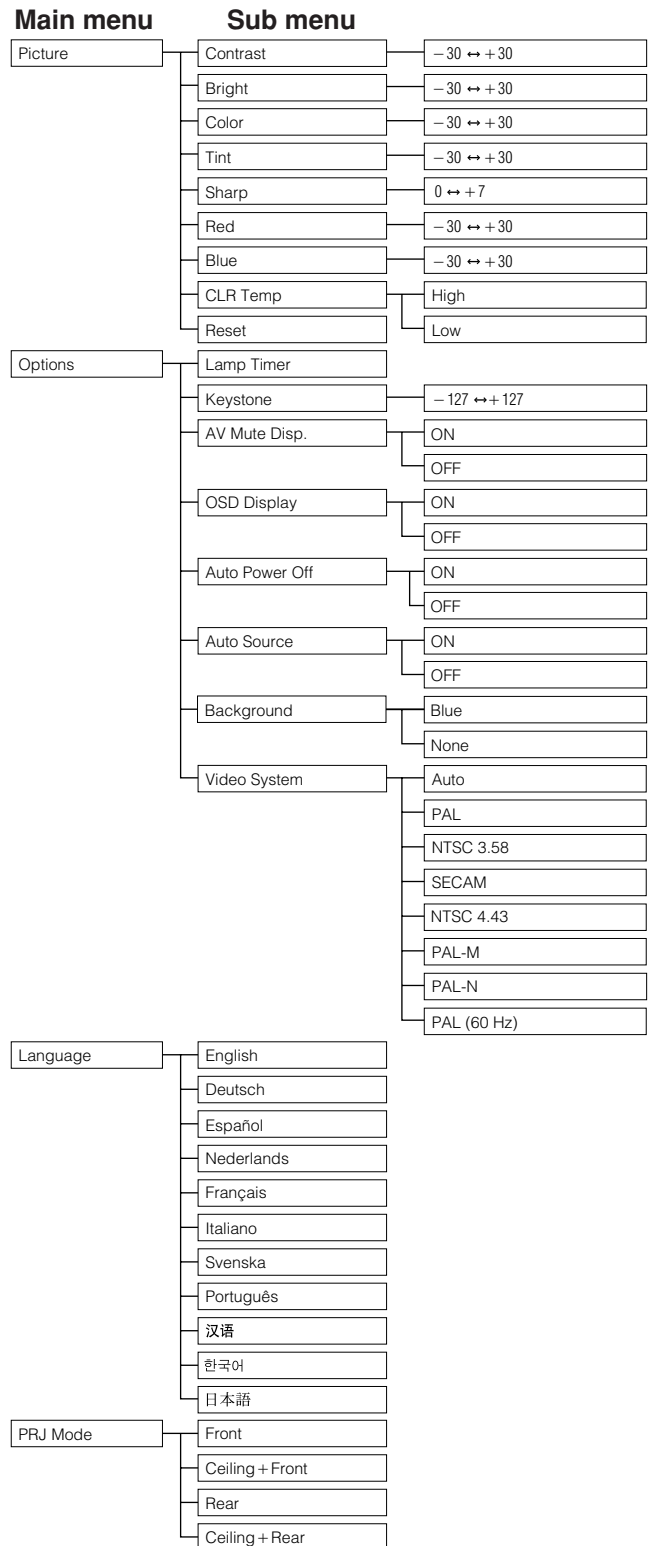

### NOTE

- "Tint" does not appear when receiving "PAL", "SECAM", "PAL-M", "PAL-N" or "PAL (60Hz)" in the INPUT 2 (S-VIDEO) or INPUT 3 (VIDEO) mode.





# Selecting the On-screen Display Language

## Projector

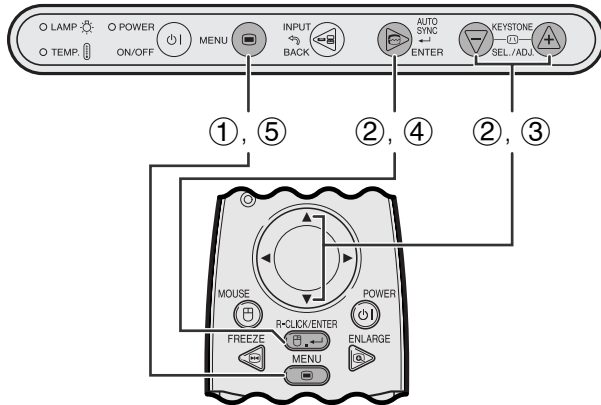

## Remote control

### (GUI) On-screen Display



English is the preset language for the On-screen Display. The language can be set to English, German, Spanish, Dutch, French, Italian, Swedish, Portuguese, Chinese, Korean or Japanese.

- ① Press **MENU**.
- ② Press **▲/▼** to select “Language”, and then press **ENTER**.
- ③ Press **▲/▼** to select the desired language.
- ④ Press **ENTER** to save the setting. The On-screen Display is now programmed to display in the language selected.
- ⑤ To exit from the GUI, press **MENU**.



# Selecting the Video Input System Mode (INPUT 2 or 3 only)

## Projector

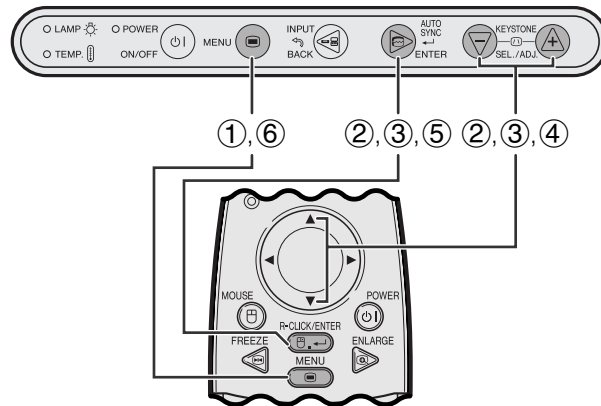

## Remote control

### (GUI) On-screen Display

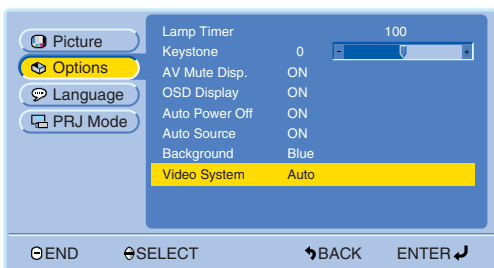

The video input system mode is preset to “Auto”; however, it can be changed to a specific system mode, if the selected system mode is not compatible with the connected audiovisual equipment.

- ① Press **MENU**.
- ② Press **▲/▼** to select “Options”, and then press **ENTER**.
- ③ Press **▲/▼** to select “Video Systems”, and then press **ENTER**.
- ④ Press **▲/▼** to select the desired video system mode.
- ⑤ Press **ENTER** to save the setting.
- ⑥ To exit from the GUI, press **MENU**.

### NOTE

- When the system mode is set to “Auto”, you may not receive a clear picture due to signal differences. Should this occur, switch to the video system of the source signal.



# Picture Adjustments

## Projector

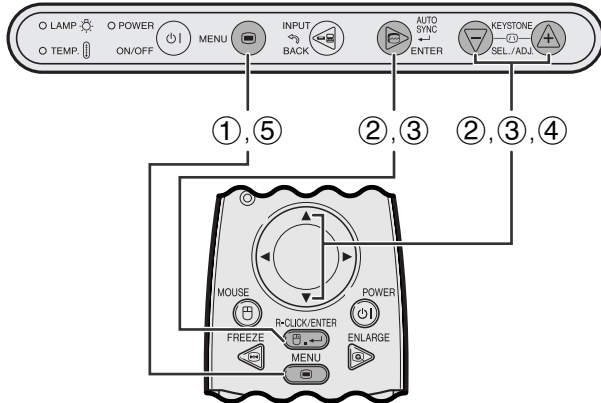

## Remote control

### (GUI) On-screen Display

#### INPUT 1 (RGB) Mode



#### INPUT 1 (COMPONENT) Mode



#### INPUT 2 (S-VIDEO) or INPUT 3 (VIDEO) Mode



## Adjusting the Picture

You can adjust the projector's picture to your preferences with the following picture settings.

### Description of Adjustment Items

Selected item	▼ button	▲ button
<b>Contrast</b>	For less contrast	For more contrast
<b>Bright</b>	For less brightness	For more brightness
<b>Color</b>	For less color intensity	For more color intensity
<b>Tint</b>	Skin tones become purplish	Skin tones become greenish
<b>Sharp</b>	For less sharpness	For more sharpness
<b>Red</b>	For weaker red	For stronger red
<b>Blue</b>	For weaker blue	For stronger blue
<b>Reset</b>	All image adjustment items are returned to the factory preset settings.	

### NOTE

- These adjustments do not work in INPUT 1 (DVI) mode.
- "Color", "Tint" and "Sharp" do not appear in INPUT 1 (DVI) or (RGB) mode.

- 1 Press **MENU**.
- 2 Press ▲/▼ to select "Picture", and then press **ENTER**.
- 3 Press ▲/▼ to select a specific adjustment item, and then press **ENTER**.  
The items except the selected one will be displayed in gray.
- 4 Press ▲/▼ to move the ▾ mark of the selected adjustment item to the desired setting.
- 5 To exit from the GUI, press **MENU**.

### NOTE

- To reset all adjustment items, select "Reset", and then press **ENTER**.







## Projector

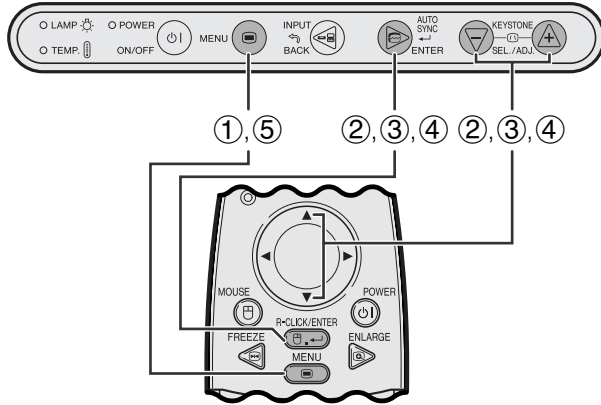

## Remote control

### (GUI) On-screen Display

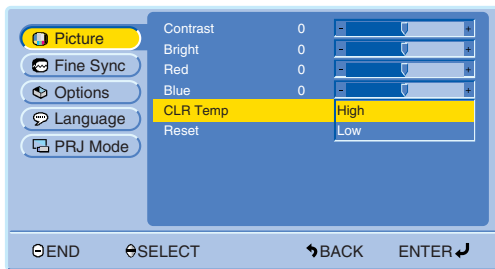

## Selecting the Color Temperature

This function can be used to adjust the color temperature to suit the type of image input to the projector (video, computer image, TV broadcast, etc.). Decrease the color temperature to create warmer, reddish images for natural flesh tones. Increase the color temperature to create cooler, bluish images for a brighter picture.

### Description of Color Temperature

Selected item	Description
<b>High</b>	Increases color temperature for cooler, bluish, fluorescent-like images. (High color temperature)
<b>Low</b>	Decreases color temperature for warmer, reddish, incandescent-like images. (Low color temperature)

- ① Press **MENU**.
- ② Press **▲/▼** to select "Picture", and then press **ENTER**.
- ③ Press **▲/▼** to select "CLR Temp", and then press **ENTER**.
- ④ Press **▲/▼** to select "High" or "Low", and then press **ENTER**.
- ⑤ To exit from the GUI, press **MENU**.





# Computer Image Adjustments (INPUT 1 (RGB) mode only)

## Projector

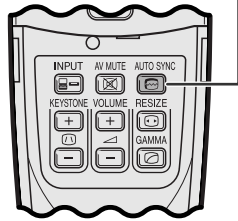
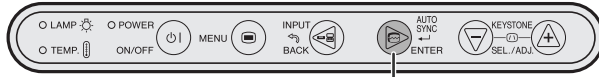

## Remote control

### On-screen Display

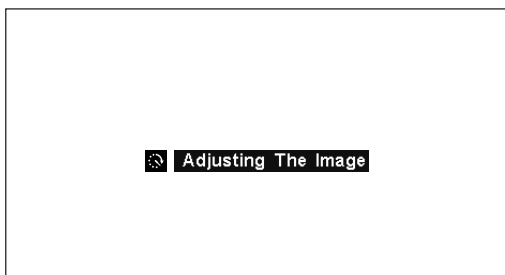

## Auto Sync Adjustment

- Used to automatically adjust a computer image.
- Auto Sync adjustment can be made manually by pressing **AUTO SYNC**.

- ① Press **AUTO SYNC**.

During Auto Sync adjustment, “Adjusting The Image” is displayed as shown on the left.

### NOTE

- Auto Sync adjustment may take some time to complete, depending on the image of the computer connected to the projector.
- When the optimum image cannot be achieved with Auto Sync adjustment, use manual adjustments. (See the steps below.)

## Projector

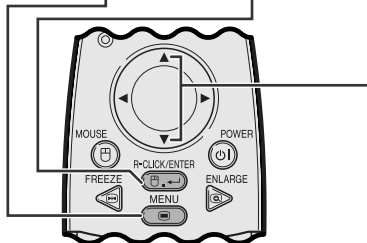
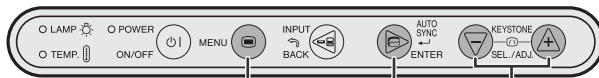

## Remote control

### (GUI) On-screen Display

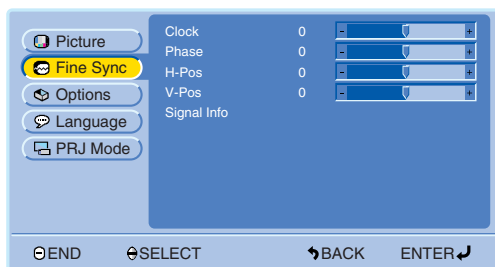

## Adjusting the Computer Image

When displaying computer patterns which are very detailed (tiling, vertical stripes, etc.), interference may occur, causing flickering, vertical stripes, or contrast irregularities in portions of the screen. Should this occur, adjust “Clock”, “Phase”, “H-Pos” and “V-Pos” for the optimum computer image.

### Description of Adjustment Items

Selected item	Description
<b>Clock</b>	Adjusts vertical noise.
<b>Phase</b>	Adjusts horizontal noise (similar to tracking on your VCR).
<b>H-Pos</b>	Centers the on-screen image by moving it to the left or right.
<b>V-Pos</b>	Centers the on-screen image by moving it up or down.

### NOTE

- Computer image adjustments can be made easily by pressing **AUTO SYNC** (🔊). See the step above for details.

(Select the desired computer input mode with **INPUT**.)

- ① Press **MENU**.
- ② Press **▲/▼** to select “Fine Sync”, and then press **ENTER**.
- ③ Press **▲/▼** to select a specific adjustment item, and then press **ENTER**.
- ④ Press **▲/▼** to move the **↓** mark of the selected adjustment item to the desired setting.
- ⑤ To exit from the GUI, press **MENU**.



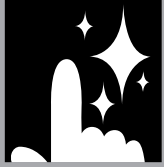

# Useful Features

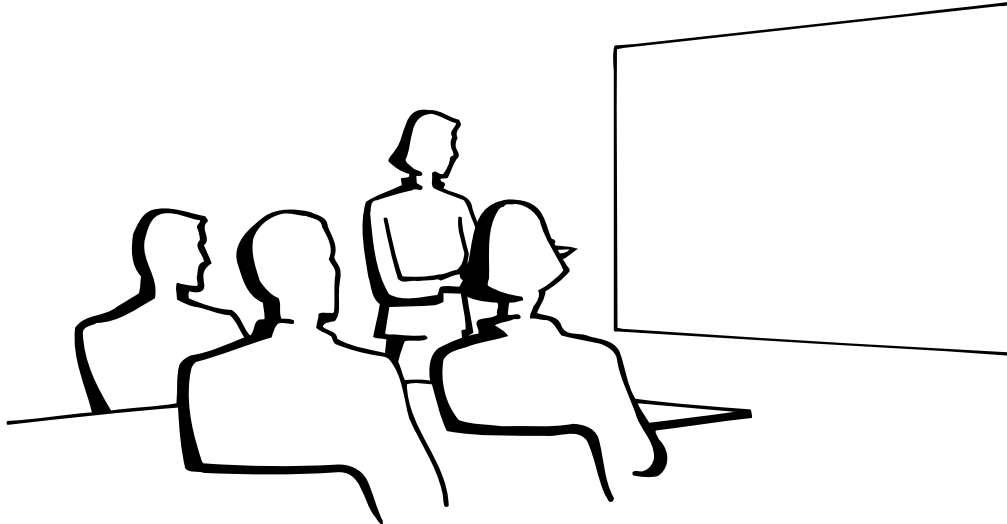

## Freeze Function

### Remote control

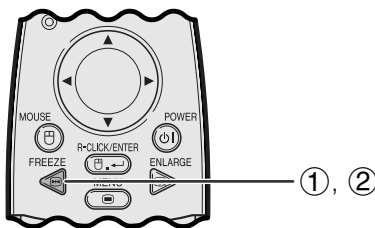

This function allows you to instantly freeze a moving image. This is useful when you want to display a still image from a computer or video, giving you more time to explain the image to the audience.

You can also use this function to display a still image from a computer while you make preparations for the next computer images to be presented.

- ① Press **FREEZE** on the remote control to freeze the image.
- ② Press **FREEZE** again to return to the moving image.

### On-screen Display



- If the input signal is changed by pressing **INPUT** during FREEZE, the function releases.





# Digital Image Magnification

## Remote control

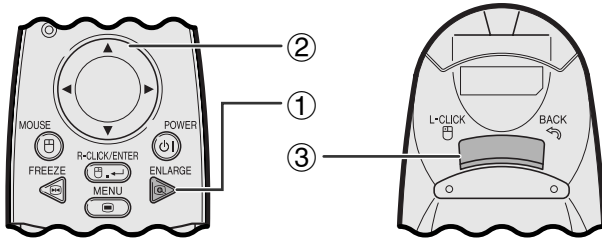

This function allows you to magnify a specific portion of an image. This is useful when you want to display a detailed portion of the image.

- ① Press **ENLARGE** on the remote control. Each time **ENLARGE** is pressed, the image will be magnified.
- ② When the image is magnified, you can pan and scan around the image by using **▲/◀/▼/▶**.
- ③ To return to  $\times 1$ , press **BACK** (on the remote control only).

## On-screen Display

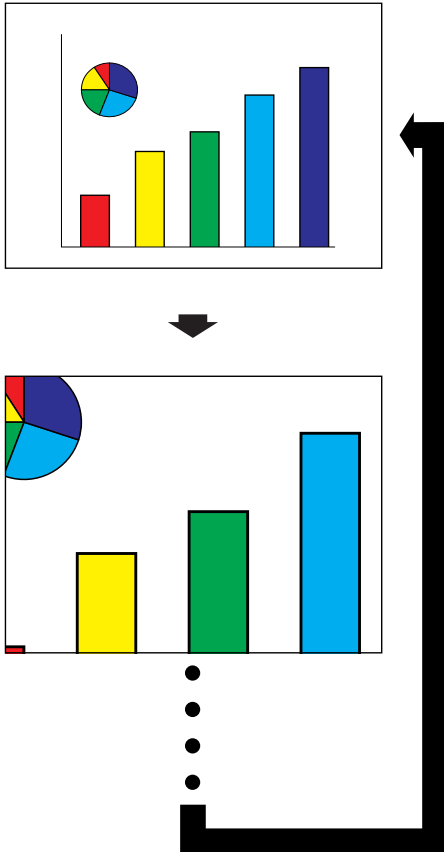

### NOTE

- Each time **ENLARGE** is pressed, image magnification toggles as shown below.

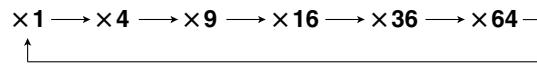

- If the input signal is changed during digital image magnification, the image will return to  $\times 1$ . The input signal is changed
  - (a) when **INPUT** is pressed,
  - (b) when the input signal is interrupted, or
  - (c) when the input resolution and refresh rate changes.





# Selecting the Picture Display Mode

## Remote control

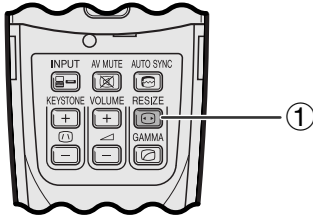

This function allows you to modify or customize the picture display mode to enhance the input image. Depending on the input signal, you can choose the picture display mode preferred.

- Press **RESIZE** on the remote control. Each time **RESIZE** is pressed, the picture mode changes as shown below.

## COMPUTER

### EXAMPLE

### PG-M15X

		NORMAL	DOT BY DOT
4:3 aspect ratio	SVGA (800 × 600)	1024 × 768	800 × 600
	XGA (1024 × 768)	1024 × 768	–
Other aspect ratios	SXGA (1280 × 1024)	1024 × 768	1280 × 1024

### PG-M15S

		NORMAL	DOT BY DOT
4:3 aspect ratio	SVGA (800 × 600)	800 × 600	–
	XGA (1024 × 768)	800 × 600	1024 × 768
Other aspect ratios	SXGA (1280 × 1024)	800 × 600	1280 × 1024

	Input Signal	Output screen image	
		NORMAL Projects a full screen image.	DOT BY DOT Projects the original resolution signal of the image.
VGA, SVGA (PG-M15X) VGA (PG-M15S)			
XGA (PG-M15X) SVGA (PG-M15S)			
XGA (PG-M15S)			
SXGA (PG-M15X) SXGA (PG-M15S)			

### NOTE

#### PG-M15X

- When inputting an XGA (1024 × 768) signal, the image display is set in NORMAL mode, and DOT BY DOT selection is not available.

#### PG-M15S

- When inputting an SVGA (800 × 600) signal, the image display is set in NORMAL mode, and DOT BY DOT selection is not available.





# Selecting the Picture Display Mode

## DVD/VIDEO

### EXAMPLE

#### PG-M15X

		NORMAL	STRETCH	BORDER
4:3 aspect ratio 480i, NTSC, PAL, SECAM	4:3	1024 × 768	1024 × 576	768 × 576
	Letterbox	1024 × 768	1024 × 576	768 × 576
	Squeeze	1024 × 768	1024 × 576	768 × 576

#### PG-M15S

		NORMAL	STRETCH	BORDER
4:3 aspect ratio 480i, NTSC, PAL, SECAM	4:3	800 × 600	800 × 450	600 × 450
	Letterbox	800 × 600	800 × 450	600 × 450
	Squeeze	800 × 600	800 × 450	600 × 450

#### NOTE

- Letterbox: The 4:3 pixel area where the image is recorded. The black bands at the top and bottom are unused pixels.
- Squeeze: Compresses an enhanced image (e.g. 16:9) to a 4:3 image display.

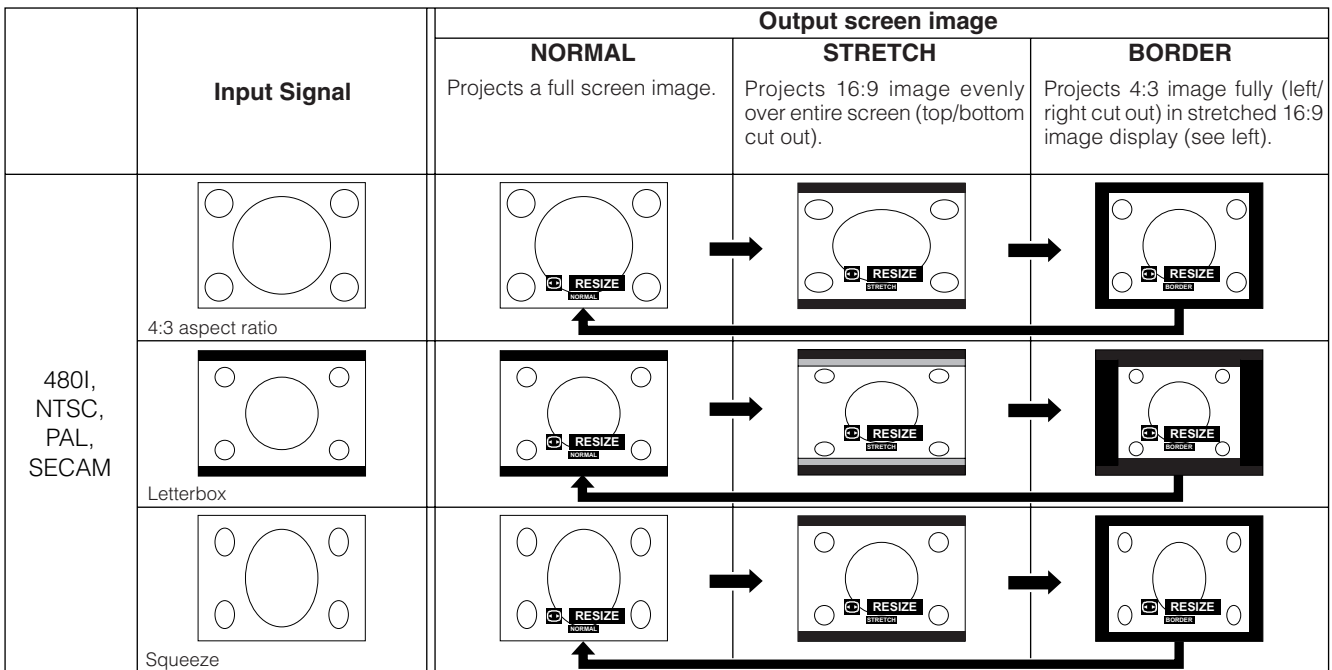



# Gamma Correction

## Remote control

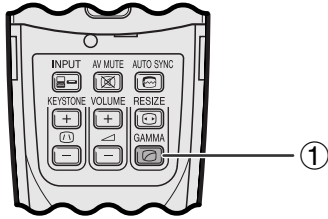

## On-screen Display

STANDARD

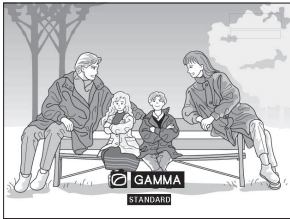

GAMMA 1

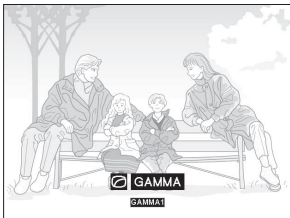

GAMMA 2

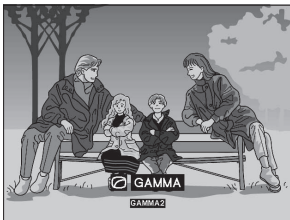

- Gamma is an image quality enhancement function that offers a richer image by brightening the darker portions of the image without altering the brightness of the brighter portions.
- Three gamma settings are available to allow for differences in the images displayed and in the brightness of the room.
- When you are displaying images with frequent, dark scenes, such as a film or concert, or when you are displaying images in a bright room, this feature makes the dark scenes easier to see and gives the impression of greater depth in the image.

## Gamma Modes

Selected Mode	Gamma mode
STANDARD	Standard picture without gamma correction.
GAMMA 1	Brightens darker portions of image for more enhanced presentations.
GAMMA 2	Gives greater depth to darker portions of image for a more exciting theater experience.

- ① Press **GAMMA** on the remote control. Each time **GAMMA** is pressed, the gamma level toggles as shown on the left.







# Checking the Input Signal (INPUT 1 (DVI) mode or (RGB) mode only)

## Projector

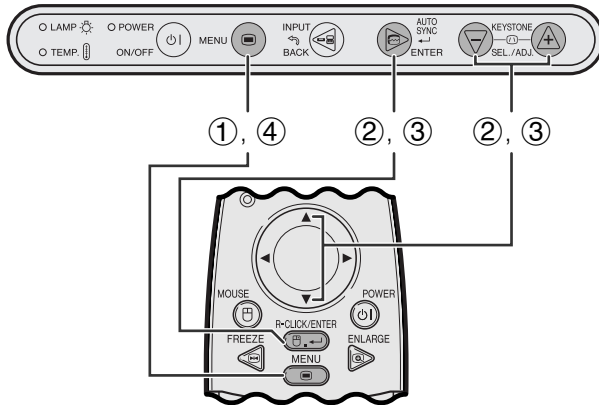

This function allows you to check the current input signal information.

- ① Press **MENU**.
- ② Press **▲/▼** to select “Fine Sync”, and then press **ENTER**.
- ③ Press **▲/▼** to select “Signal Info”, and then press **ENTER**.
- ④ To exit from the GUI, press **MENU**.

## Remote control

### (GUI) On-screen Display

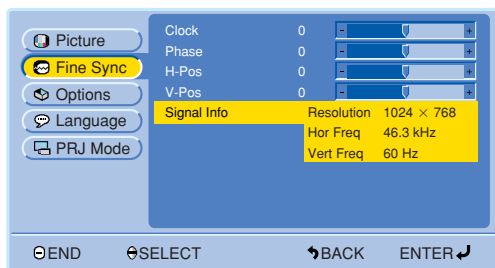

# Checking the Lamp Usage Time

## Projector

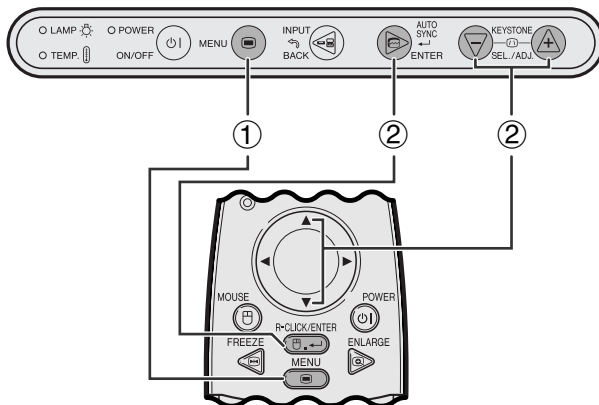

This function allows you to check the accumulated lamp usage time.

- ① Press **MENU**.
- ② Press **▲/▼** to select “Options”, and then press **ENTER**. The current lamp usage time will be displayed.

### NOTE

- It is recommended that the lamp be replaced after approximately 1,400 hours of usage. See pages 47 and 48 for lamp replacement.

## Remote control

### (GUI) On-screen Display





# Turning On/Off the AV Mute Message

## Projector

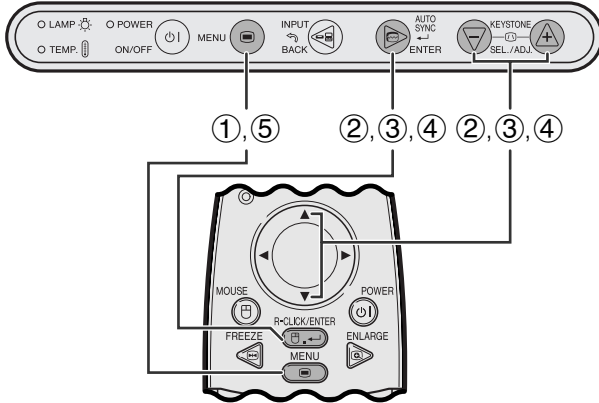

## Remote control

### (GUI) On-screen Display

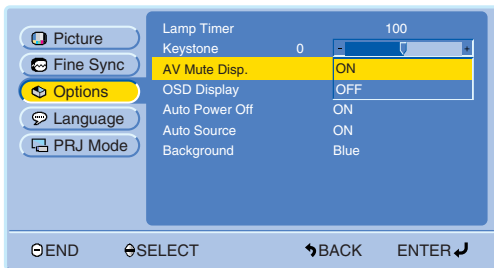

### On-screen Display



This function allows you to turn off the on-screen message that appears during AV mute is on.

### Description of AV Mute Display

Selected item	Description
<b>ON</b>	"AV MUTE" is displayed.
<b>OFF</b>	"AV MUTE" is not displayed.

- ① Press **MENU**.
- ② Press **▲/▼** to select "Options", and then press **ENTER**.
- ③ Press **▲/▼** to select "AV Mute Disp", and then press **ENTER**.
- ④ Press **▲/▼** to select "ON" or "OFF", and then press **ENTER**.
- ⑤ To exit from the GUI, press **MENU**.





# On-screen Display Override Function

## Projector

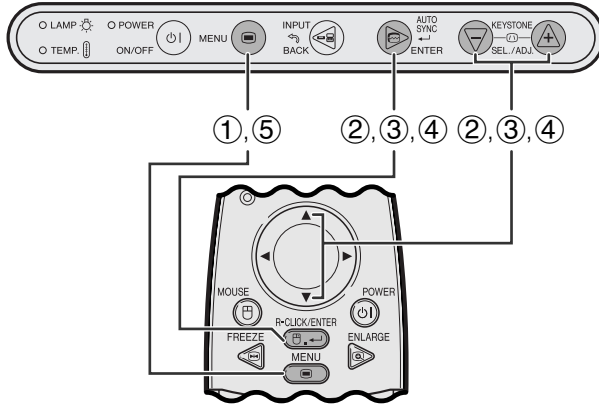

## Remote control

### (GUI) On-screen Display

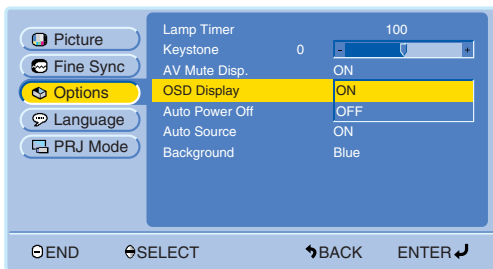

### On-screen Display



This function allows you to turn off the on-screen messages that appear during input select. Once “OSD Display” is set to “OFF” in the GUI menu, the on-screen messages will not appear.

### Description of OSD Display

Selected item	Description
<b>ON</b>	On-screen Display is displayed.
<b>OFF</b>	On-screen Display is not displayed.

- ① Press **MENU**.
- ② Press **▲/▼** to select “Options”, and then press **ENTER**.
- ③ Press **▲/▼** to select “OSD Display”, and then press **ENTER**.
- ④ Press **▲/▼** to select “ON” or “OFF”, and then press **ENTER**.
- ⑤ To exit from the GUI, press **MENU**.





# Automatic Power Shutoff Function

## Projector

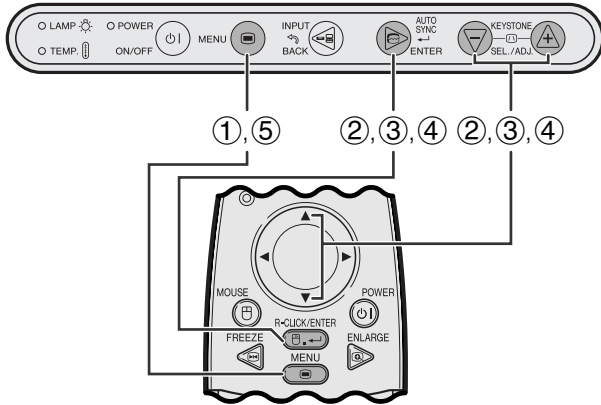

## Remote control

### (GUI) On-screen Display

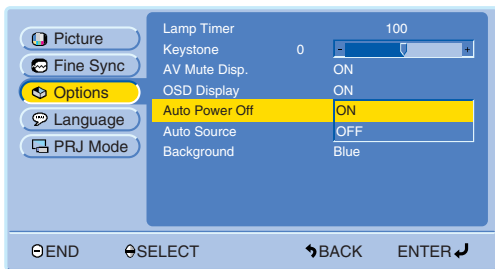

### On-screen Display

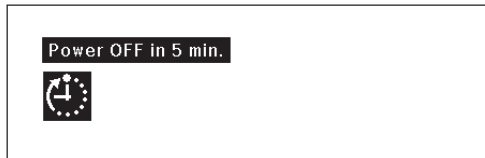

When no input signal is detected for approximately 15 minutes, the projector will automatically shut off. The on-screen message as below will appear five minutes before the power automatically shuts off.

### Description of Automatic Power Shutoff

Selected item	Description
ON	Power automatically shuts off after approximately 15 minutes if no signal is input.
OFF	Automatic Power Shutoff disabled.

- ① Press **MENU**.
- ② Press **▲/▼** to select "Options", and then press **ENTER**.
- ③ Press **▲/▼** to select "Auto Power Off", and then press **ENTER**.
- ④ Press **▲/▼** to select "ON" or "OFF", and then press **ENTER**.
- ⑤ To exit from the GUI, press **MENU**.





# Detecting the Input Source Automatically

## Projector

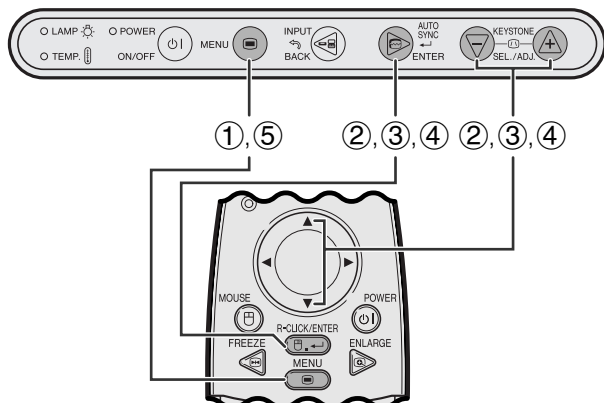

## Remote control

### (GUI) On-screen Display

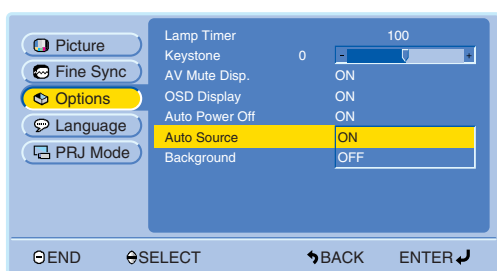

This function is used to detect the input source automatically.

### Description of Auto Source

Selected item	Description
<b>ON</b>	<ul style="list-style-type: none"> <li>Automatically selects the input source connected to the projector.</li> <li>If the signal stops, automatically switches to an input source that is transmitting a signal.</li> <li>For multiple signal input, can skip the input source that has no input signal and selects the one that has a signal.</li> </ul>
<b>OFF</b>	<ul style="list-style-type: none"> <li>Manually select the input source connected to the projector.</li> </ul>

- Press **MENU**.
- Press **▲/▼** to select "Options", and then press **ENTER**.
- Press **▲/▼** to select "Auto Source", and then press **ENTER**.
- Press **▲/▼** to select "ON" or "OFF", and then press **ENTER**.
- To exit from the GUI, press **MENU**.

#### NOTE

- When set to "ON", you will be unable to manually select an inactive input by pressing **INPUT**.



# Selecting a Background Image

## Projector

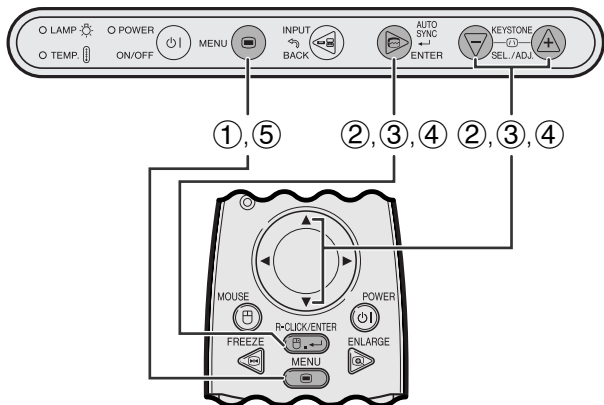

## Remote control

### (GUI) On-screen Display

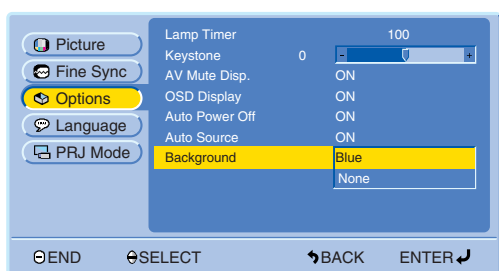

This function allows you to select the image displayed when no signal is being sent to the projector.

### Description of Background Images

Selected item	Description
<b>Blue</b>	Blue screen
<b>None</b>	Black screen

- Press **MENU**.
- Press **▲/▼** to select "Options", and then press **ENTER**.
- Press **▲/▼** to select "Background", and then press **ENTER**.
- Press **▲/▼** to select "Blue" or "None", and then press **ENTER**.
- To exit from the GUI, press **MENU**.





# Reverse/Invert Image Function

## Projector

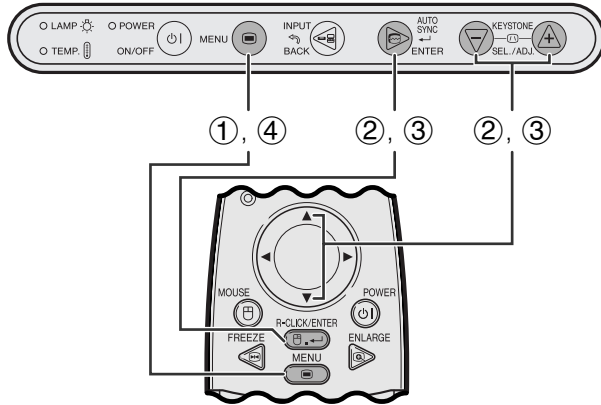

## Remote control

### (GUI) On-screen Display

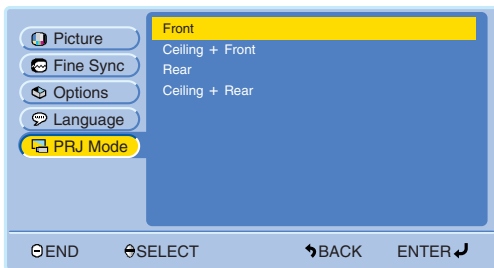

This projector is equipped with a reverse/invert image function which allows you to reverse or invert the projected image for various applications.

### Description of Projected Images

Selected item	Projected image
Front	Normal image
Ceiling + Front	Inverted image
Rear	Reversed image
Ceiling + Rear	Reversed and inverted image

- ① Press **MENU**.
- ② Press **▲/▼** to select “PRJ Mode”, and then press **ENTER**.
- ③ Press **▲/▼** to select the desired projection mode, and then press **ENTER**.
- ④ To exit from the GUI, press **MENU**.

#### NOTE

- This function is used for the reversed image and ceiling-mount setups. See page 22 for these setups.





# Maintenance & Troubleshooting

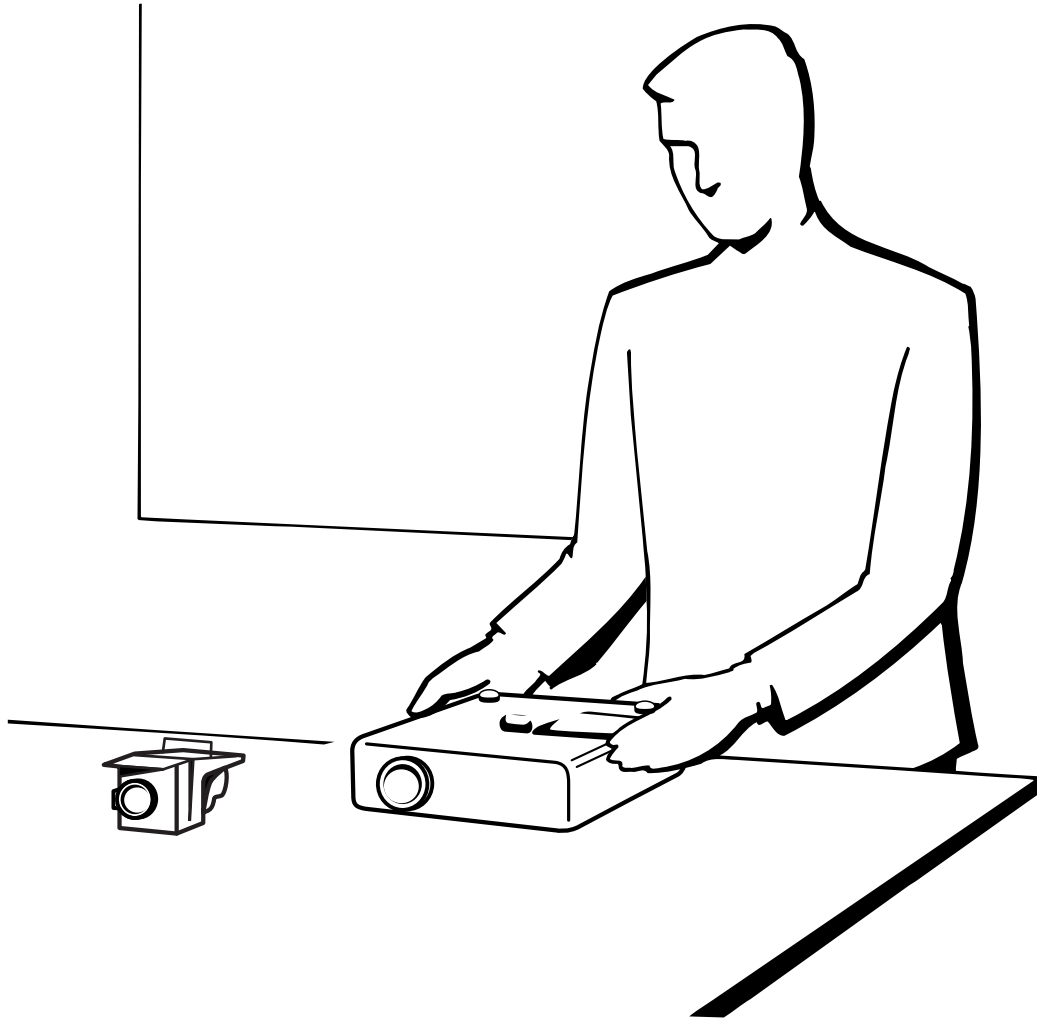





# Lamp/Maintenance Indicators

## Maintenance Indicators

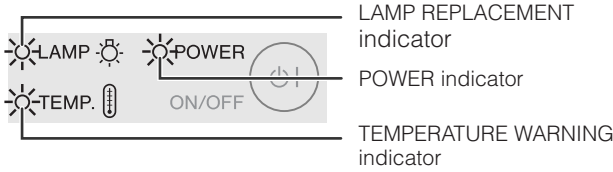

- The warning lights on the projector indicate problems inside the projector.
- There are two warning lights: a TEMPERATURE WARNING indicator which warns that the projector is too hot, and a LAMP REPLACEMENT indicator which lets you know when to change the lamp.
- If a problem occurs, either the TEMPERATURE WARNING indicator or the LAMP REPLACEMENT indicator will illuminate red. After turning off the power, follow the procedures given below.

Maintenance Indicator	Condition	Problem	Possible Solution
TEMPERATURE WARNING indicator	The internal temperature is abnormally high.	<ul style="list-style-type: none"> <li>• Blocked air intake.</li> <li>• Cooling fan breakdown.</li> <li>• Internal circuit failure.</li> </ul>	<ul style="list-style-type: none"> <li>• Relocate the projector to an area with proper ventilation.</li> <li>• Take the projector to your nearest Sharp Authorized Projector Dealer or Service Center for repair.</li> </ul>
	The indicator flashes in red.	<ul style="list-style-type: none"> <li>• Cooling down.</li> </ul>	<ul style="list-style-type: none"> <li>• Wait until the indicator stops flashing and turns off.</li> </ul>
LAMP REPLACEMENT indicator	The lamp does not illuminate.	<ul style="list-style-type: none"> <li>• Burnt-out lamp.</li> <li>• Lamp circuit failure.</li> <li>• The lamp cage cover is not securely installed.</li> </ul>	<ul style="list-style-type: none"> <li>• Carefully replace the lamp. (See pages 47 and 48.)</li> <li>• Take the projector to your nearest Sharp Authorized Projector Dealer or Service Center for repair.</li> </ul>
	The lamp requires replacement.	<ul style="list-style-type: none"> <li>• Lamp has been used for over 1,400 hours.</li> </ul>	

### NOTE

- If the TEMPERATURE WARNING indicator illuminates, follow the above possible solutions and then wait until the projector has cooled down completely before turning the power back on. (At least 5 minutes.)
- If the power is turned off and then turned on again, as during a brief rest, the LAMP REPLACEMENT indicator may be triggered, preventing the power from going on. Should this occur, take the power cord out of the wall outlet and put it back in again.

## Lamp

The lamp in this projector operates for approximately 1,500 cumulative hours, depending on the usage environment. It is recommended that the lamp be replaced after 1,400 cumulative hours of use or when you notice a significant deterioration of the picture and color quality. The lamp usage time can be checked with the On-screen Display. (See page 39.)

### CAUTION

- Intense light hazard. Do not attempt to look into the aperture and lens while the projector is operating.

### NOTE

- As the usage environment can vary significantly, the projector lamp may not operate for 1,500 hours.
- "1,500 hours" above indicates average life span and should be used for reference only. This is different than the warranty period.
- For safety, the power will not be turned on from the fourth time when turning on the power without changing the lamp after use for 1,500 hours.

Condition	Problem	Possible Solution
The LAMP REPLACEMENT indicator illuminates red, and "LAMP" will appear in yellow in the lower-left corner of the picture.	<ul style="list-style-type: none"> <li>• Lamp has been used for over 1,400 hours.</li> </ul>	<ul style="list-style-type: none"> <li>• Purchase a replacement lamp unit (lamp cage/module) of the current type BQC-PGM15X//1 from your nearest Sharp Authorized Projector Dealer or Service Center.</li> </ul>
A significant deterioration of the picture and color quality occurs.		<ul style="list-style-type: none"> <li>• Replace the lamp. (See pages 47 and 48.)</li> </ul>
The power will automatically turn off and the projector will enter standby mode.	<ul style="list-style-type: none"> <li>• Lamp has been used for over 1,500 hours.</li> </ul>	<ul style="list-style-type: none"> <li>• If you wish, you may have the lamp replaced at your nearest Sharp Authorized Projector Dealer or Service Center.</li> </ul>
"LAMP" will appear in red in the lower-left corner of the picture, and the power will turn off.		





# Replacing the Projection Lamp

## CAUTION

- Potential hazard of glass particles if lamp ruptures. Please have Sharp Authorized Projector Dealer or Service Center replace lamp if rupture occurs.
- Do not remove the lamp cage directly after operation of the projector. The lamp may be extremely hot. Wait at least one hour after the power cord is disconnected to allow the surface of the lamp cage to fully cool before removing the lamp cage.

It is recommended that the lamp be replaced after approximately 1,400 cumulative hours of use or when you notice a significant deterioration of the picture and color quality. Carefully change the lamp by following the steps below.

If the new lamp does not light after replacement, take your projector to the nearest Sharp Authorized Projector Dealer or Service Center for repair. Purchase a replacement lamp unit (lamp cage/module) of the current type BQC-PGM15X//1 from your nearest Sharp Authorized Projector Dealer or Service Center. Then carefully change the lamp by following the instructions below. If you wish, you may have the lamp replaced at your nearest Sharp Authorized Projector Dealer or Service Center.

## IMPORTANT NOTE TO U.S. CUSTOMERS:

The lamp included with this projector is backed by a 90-day parts and labor limited warranty. All service of this projector under warranty, including lamp replacement, must be obtained through a Sharp Authorized Projector Dealer or Service Center. For the name of the nearest Sharp Authorized Projector Dealer or Service Center, please call toll-free: 1-888-GO-SHARP (1-888-467-4277).

U.S.A. ONLY

## Removing and installing the lamp unit

## CAUTION

- Be sure to remove the lamp cage by the handle. Be sure not to touch the glass surface of the lamp cage or the inside of the projector.
- To avoid injury to yourself and damage to the lamp, be sure to carefully follow the steps below.

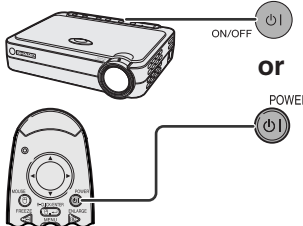
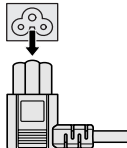
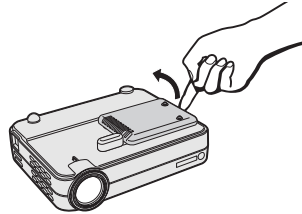
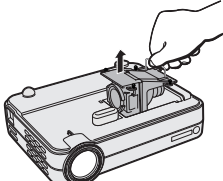
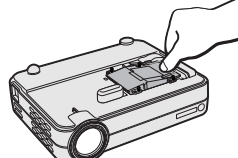
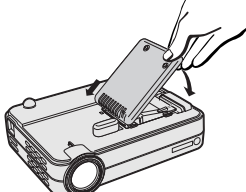

<p><b>1 Turn off the power.</b></p>	<p><b>2 Disconnect the power cord.</b></p>	<p><b>3 Remove the lamp cage cover.</b></p>
<p>Press <b>ON/OFF</b> on the projector or <b>POWER</b> on the remote control. Wait until the cooling fan stops.</p> 	<p>Unplug the power cord from the AC socket.</p> 	<p>Turn over the projector and loosen the user service screws that secure the lamp cage cover. Then lift open the cover in the direction of the arrow.</p> 
<p><b>4 Remove the lamp cage.</b></p>	<p><b>5 Insert the new lamp cage.</b></p>	<p><b>6 Attach the lamp cage cover.</b></p>
<p>Loosen the securing screws on the lamp cage. Hold the lamp cage by the handle and pull it towards you.</p> 	<p>Press the lamp cage firmly into the lamp cage compartment. Fasten the securing screws.</p> 	<p>Slide the lamp cage cover in the direction of the arrow. Then tighten the user service screws.</p> 



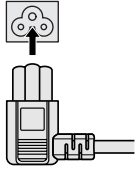
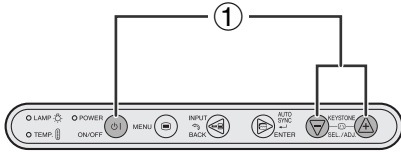

## Replacing the Projection Lamp

### Resetting the lamp timer

<p><b>1 Connect the power cord.</b></p> <p>Plug the power cord into the AC socket of the projector.</p> 	<p><b>2 Reset the lamp timer.</b></p> <p>① Press <b>KEYSTONE (+)</b> and <b>KEYSTONE (-)</b> simultaneously and <b>ON/OFF</b> at the same time.</p> 	<p>"LAMP 0000H" is displayed, indicating that the lamp timer is reset.</p> 
---	--	--

#### NOTE

- Reset the lamp timer only after replacing the lamp.



## Using the Kensington Lock

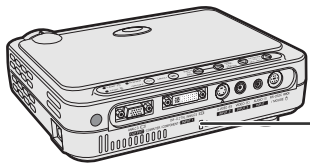

Kensington Security Standard connector

This projector has a Kensington Security Standard connector for use with a Kensington MicroSaver Security System. Refer to the information that came with the system for instructions on how to use it to secure the projector.



## Troubleshooting

Problem	Check
No picture and no sound.	<ul style="list-style-type: none"> <li>• Projector power cord is not plugged into the wall outlet.</li> <li>• Selected input is wrong. (See page 19.)</li> <li>• Cables incorrectly connected to the rear panel of the projector. (See pages 13–17.)</li> <li>• Remote control batteries have run down. (See page 10.)</li> <li>• The lamp cage cover is not securely installed (See page 47.).</li> </ul>
Sound is heard but no picture appears.	<ul style="list-style-type: none"> <li>• Cables incorrectly connected to the rear panel of the projector. (See pages 13–17.)</li> <li>• "Contrast" and "Bright" adjustments are set to minimum position. (See page 31.)</li> </ul>
Color is faded or poor.	<ul style="list-style-type: none"> <li>• "Color" and "Tint" adjustments are not correct. (See page 31.)</li> </ul>
Picture is blurred.	<ul style="list-style-type: none"> <li>• Adjust the focus. (See page 19.)</li> <li>• Projection distance is too long or too short to allow for proper focus. (See pages 20–21.)</li> </ul>
Picture appears but no sound is heard.	<ul style="list-style-type: none"> <li>• Cables incorrectly connected to the rear panel of the projector. (See pages 13–17.)</li> <li>• Volume is set to minimum. (See page 19.)</li> </ul>
An unusual sound is occasionally heard from the cabinet.	<ul style="list-style-type: none"> <li>• If the picture is normal, the sound is due to cabinet shrinkage caused by temperature changes. This will not affect operation or performance.</li> </ul>
Maintenance indicator illuminates.	<ul style="list-style-type: none"> <li>• Refer to "Lamp/Maintenance Indicators" on page 46.</li> </ul>
Picture noise appears.	<ul style="list-style-type: none"> <li>• Adjust the "Phase" setting. (See page 33.)</li> </ul>
Lamp does not light.	<ul style="list-style-type: none"> <li>• The lamp cage cover is not securely installed (See page 47.).</li> </ul>





# Appendix

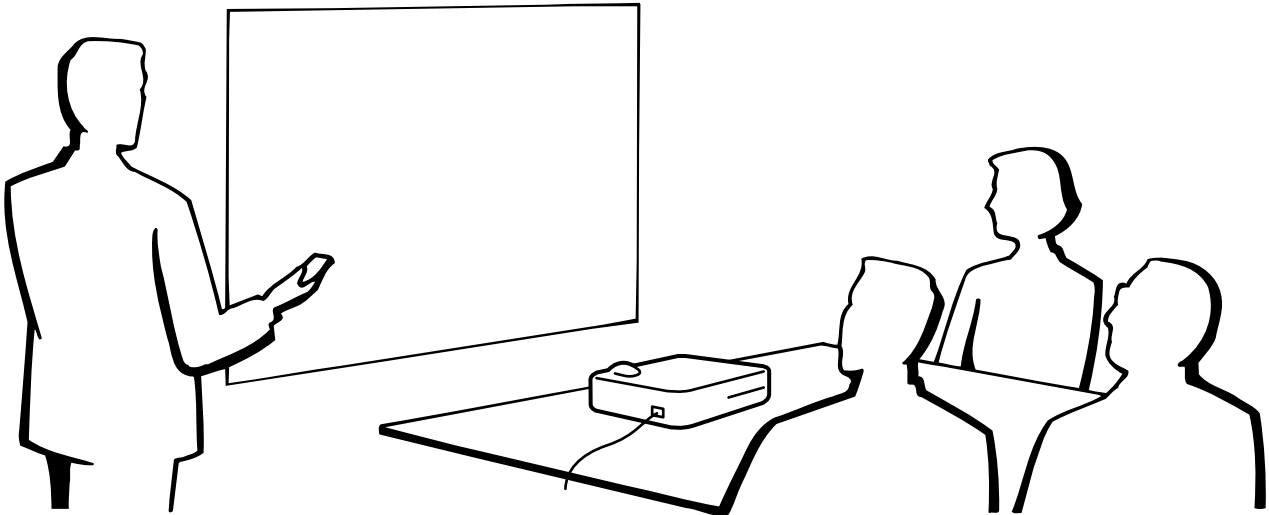

## Using the Soft Carrying Pouch

Use the soft carrying pouch to prevent damage to your projector and its lens when transporting.

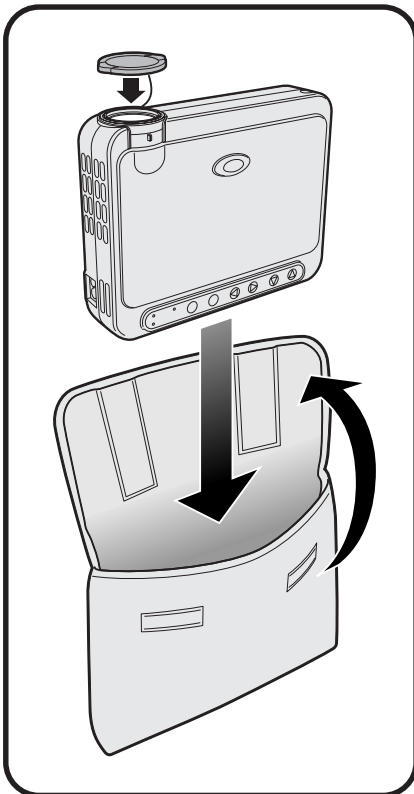

### CAUTION

- Do not lift or carry the projector by the lens or the lens cap as this may damage the lens.
- Besides the projector, do not put anything else into the soft carrying pouch.
- Be sure that the projector has cooled properly before placing the unit into its soft carrying pouch.
- Use the soft carrying pouch only when storing or carrying the projector.
- Do not leave the projector exposed to direct sunlight, locked up in a car without proper ventilation, or near equipment that radiates heat.

### Lens cap installation

Install as shown in image on the right.

When removing the lens cap, pull off by pressing the two convex areas.

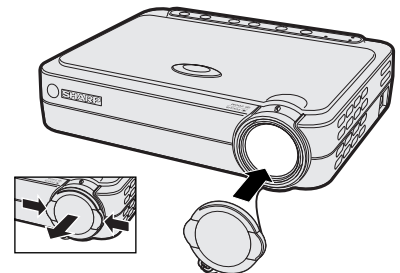



# Connection Pin Assignments

## DVI INPUT 1 Port: 29-pin

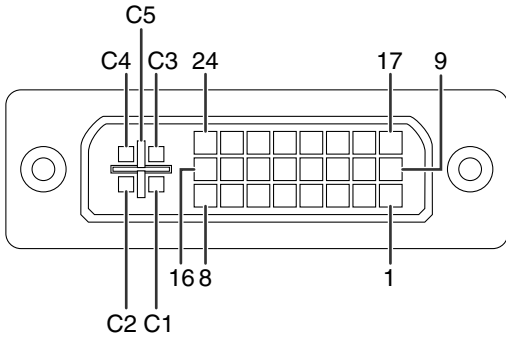

### NOTE

- \*1 Return for +5 V, Hsync. and Vsync.
- \*2 These pins are not used on this equipment.

### DVI input

Pin No.	Name
1	T.M.D.S. Data 2 -
2	T.M.D.S. Data 2 +
3	T.M.D.S. Data 2/4 Shield
4	T.M.D.S. Data 4 - *2
5	T.M.D.S. Data 4 + *2
6	DDC Clock
7	DDC Data
8	Vertical Sync
9	T.M.D.S. Data 1 -
10	T.M.D.S. Data 1 +
11	T.M.D.S. Data 1/3 Shield
12	T.M.D.S. Data 3 - *2
13	T.M.D.S. Data 3 + *2
14	+5 V Power
15	Ground*1
16	Hot Plug Detect
17	T.M.D.S. Data 0 -
18	T.M.D.S. Data 0 +
19	T.M.D.S. Data 0/5 Shield
20	T.M.D.S. Data 5 - *2
21	T.M.D.S. Data 5 + *2
22	T.M.D.S. Clock Shield
23	T.M.D.S. Clock +
24	T.M.D.S. Clock -
C1	Analog input Red
C2	Analog input Green
C3	Analog input Blue
C4	Horizontal Sync
C5	Ground

### RGB input

Pin No.	Name
1	Not connected
2	Not connected
3	Not connected
4	Not connected
5	Not connected
6	DDC Clock
7	DDC Data
8	Vertical Sync
9	Not connected
10	Not connected
11	Not connected
12	Not connected
13	Not connected
14	+5 V Power
15	Ground
16	Not connected
17	Not connected
18	Not connected
19	Not connected
20	Not connected
21	Not connected
22	Not connected
23	Not connected
24	Not connected
C1	Analog input Red
C2	Analog input Green
C3	Analog input Blue
C4	Horizontal sync
C5	Ground

### COMPONENT input

Pin No.	Name
1	Not connected
2	Not connected
3	Not connected
4	Not connected
5	Not connected
6	Not connected
7	Not connected
8	Not connected
9	Not connected
10	Not connected
11	Not connected
12	Not connected
13	Not connected
14	Not connected
15	Ground
16	Not connected
17	Not connected
18	Not connected
19	Not connected
20	Not connected
21	Not connected
22	Not connected
23	Not connected
24	Not connected
C1	Analog input Pr
C2	Analog input Y
C3	Analog input Pb
C4	Not connected
C5	Ground





## Connection Pin Assignments

**OUTPUT (INPUT 1) Signal Port:** 15-pin Mini D-sub female connector

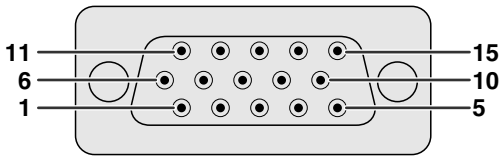

### RGB output

Analog

- 1 Video output (red)
- 2 Video output (green/sync on green)
- 3 Video output (blue)
- 4 Not connected
- 5 Not connected
- 6 Earth (red)
- 7 Earth (green/sync on green)
- 8 Earth (blue)
- 9 Not connected
- 10 GND
- 11 GND
- 12 Not connected
- 13 Horizontal sync signal
- 14 Vertical sync signal
- 15 Not connected

### COMPONENT output

Analog

- 1 P<sub>R</sub> (C<sub>R</sub>)
- 2 Y
- 3 P<sub>B</sub> (C<sub>B</sub>)
- 4 Not connected
- 5 Not connected
- 6 Earth (P<sub>R</sub>)
- 7 Earth (Y)
- 8 Earth (P<sub>B</sub>)
- 9 Not connected
- 10 Not connected
- 11 Not connected
- 12 Not connected
- 13 Not connected
- 14 Not connected
- 15 Not connected

**RS-232C Terminal:** 7-pin Mini DIN female connector

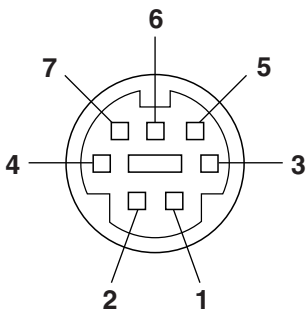

Pin No.	Signal	Name
1	VCC (USB)	USB Power
2	RD	Receive Data
3	SD	Send Data
4	USB (-)	USB Data (-)
5	GND	Signal Ground
6	USB (+)	USB Data (+)
7	NC	(Reserved)

**RS-232C Port:** 9-pin D-sub male connector of the DIN-D-sub RS-232C cable

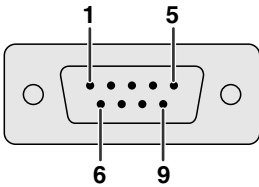

Pin No.	Signal	Name
1	CD	
2	RD	Receive Data
3	SD	Send Data
4	ER	
5	SG	Signal Ground
6	DR	Data Set Ready
7	RS	Request to Send
8	CS	Clear to Send
9	CI	

**USB connector:** 4-pin USB connector of the USB mouse control cable

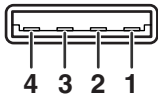

Pin No.	Signal	Name
1	VCC	USB Power
2	USB -	USB Data -
3	USB +	USB Data +
4	SG	Signal Ground





# RS-232C Port Specifications

## PC control

A computer can be used to control the projector by connecting an RS-232C cable (null modem, cross type, sold separately) to the projector. (See page 17 for connection.)

## Communication conditions

Set the serial port settings of the computer to match that of the table.

Signal format: Conforms to RS-232C standard.

Baud rate: 9,600 bps

Data length: 8 bits

Parity bit: NON

Stop bit: 1 bit

Flow control: None

## Basic format

Commands from the computer are sent in the following order: command, parameter, and return code. After the projector processes the command from the computer, it sends a response code to the computer.

*Command format*

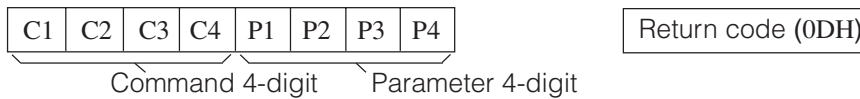

*Response code format*

Normal response



Problem response (Failure due to incorrect command/parameter or the other communication errors)



When more than one code is being sent, send each command only after the OK response code for the previous command from the projector is verified.

### NOTE

- When using the computer control function of the projector, the projector operating status cannot be read to the computer. Therefore, confirm the status by transmitting the display commands for each adjustment menu and checking the status with the On-screen Display. If the projector receives a command other than a menu display command, it will execute the command without displaying the On-screen Display.

## Commands

### EXAMPLE

- When INPUT SWITCHING is set to INPUT 1 (DVI).

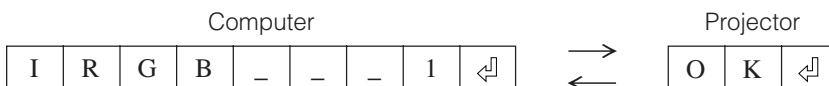

CONTROL ITEM	COMMAND				PARAMETER				CONTROL CONTENTS
	C1	C2	C3	C4	P1	P2	P3	P4	
POWER SETTING	P	O	W	R	_	_	_	0	POWER OFF (STANDBY)
	P	O	W	R	_	_	_	1	POWER ON
INPUT SWITCHING	I	R	G	B	_	_	_	1	INPUT1 (DVI)
	I	R	G	B	_	_	_	2	INPUT1 (RGB)
	I	R	G	B	_	_	_	3	INPUT1 (COMPONENT)
	I	V	E	D	_	_	_	1	INPUT2 (S-VIDEO)
	I	V	E	D	_	_	_	2	INPUT3 (VIDEO)

### NOTE

- If an underbar ( \_ ) appears in the parameter column, enter a space.





# Computer Compatibility Chart

Horizontal Frequency: 31.5–80 kHz

Vertical Frequency: 56–85 Hz

Pixel Clock: 25–135 MHz

Compatible with sync on green and **composite sync** signals

SXGA (1,280 × 1,024) compatible in intelligent compression

XGA (1,024 × 768) compatible in intelligent compression (PG-M15S only)

PC/ MAC/ WS	Resolution	Horizontal Frequency (kHz)	Vertical Frequency (Hz)	VESA Standard	Display M15S	Display M15X	
PC	VGA	640 × 350	27.0	60		Upscale	Upscale
			31.5	70			
			37.9	85	×		
		720 × 350	27.0	60			
			31.5	70			
			37.9	85	×		
		640 × 400	27.0	60			
			31.5	70	×		
			37.9	85	×		
		720 × 400	27.0	60			
			31.5	70	×		
			37.9	85	×		
	640 × 480	26.2	50				
		31.5	60	×			
		34.7	70				
		37.9	72	×			
		37.5	75	×			
		43.3	85	×			
	SVGA	800 × 600	31.3	50		True	
			35.1	56	×		
			37.9	60	×		
			44.5	70			
			48.1	72	×		
			46.9	75	×		
	XGA	1,024 × 768	35.5	43	×	Intelligent Compression	True
			40.3	50			
			48.4	60	×		
			56.5	70	×		
60.0			75	×			
68.7			85	×			
SXGA	1,152 × 864	55.0	60		Intelligent Compression	Intelligent Compression	
		66.2	70				
		67.5	75	×			
	1,152 × 882	54.8	60				
		65.9	72				
1,280 × 1,024	64.0	60	×				
PC/ MAC 13"	VGA	640 × 480	35.0	67		Upscale	Upscale
PC/ MAC 19"	XGA	1,024 × 768	48.4	60	×	Intelligent Compression	True
			60.0	75	×		
MAC 16"	SVGA	832 × 624	49.7	75		Upscale	
MAC 21"	SXGA	1,152 × 870	68.7	75		Intelligent Compression	

## NOTE

- This projector may not be able to display images from notebook computers in simultaneous (CRT/LCD) mode. Should this occur, turn off the LCD display on the notebook computer and output the display data in "CRT only" mode. Details on how to change display modes can be found in your notebook computer's operation manual.
- This projector can receive 640 × 350 VESA format VGA signals, however, "640 × 400" will appear on the screen.





# Specifications

Product type	Digital Multimedia Projector
Model	PG-M15X/PG-M15S
Video system	NTSC/NTSC 4.43/PAL/PAL-M/PAL-N/PAL 60/SECAM/DTV480i
Display method	Single Chip Digital Micromirror Device™ (DMD™) by Texas Instruments
DMD panel	Panel size: 0.7" (17.8 mm), 1 chip XGA DMD/SVGA DMD
	No. of dots: 786,432 dots (1,024 [H] × 768 [V])/PG-M15X
	480,000 dots (800 [H] × 600 [V])/PG-M15S
Lens	1-1.2 X zoom lens, F2.2-2.4, f = 28.5-34.2 mm
Projection lamp	High Intensity Discharge Lamp (HID Lamp), AC 120 W
Contrast ratio	500:1
Video input signal	RCA Connector (INPUT 3): VIDEO, composite video, 1.0 Vp-p, sync negative, 75 Ω terminated
S-video input signal	4-pin Mini DIN connector (INPUT 2) Y (luminance signal): 1.0 Vp-p, sync negative, 75 Ω terminated C (chrominance signal): Burst 0.286 Vp-p, 75 Ω terminated
Component input signal	29-pin Connector (INPUT 1) Y: 1.0 Vp-p, sync negative, 75 Ω terminated Pb: 0.7 Vp-p, 75 Ω terminated Pr: 0.7 Vp-p, 75 Ω terminated
Horizontal resolution	700 TV lines (video input)
Computer RGB input signal	29-pin CONNECTOR (INPUT 1) RGB separate/sync on green type analog input: 0-0.7 Vp-p, positive, 75 Ω terminated HORIZONTAL SYNC. SIGNAL: TTL level (positive/negative) VERTICAL SYNC. SIGNAL: Same as above
Pixel clock	25-135 MHz
Vertical frequency	56-85 Hz
Horizontal frequency	31.5-80 kHz
Audio input signal	3.5 Ø MINIJACK: AUDIO, 0.4 Vrms, more than 47 kΩ (stereo)
Audio output	2.0 W (monaural)
Speaker system	4 × 2.8 cm
Rated voltage	AC 100-240 V
Input current	2.0 A
Rated frequency	50/60 Hz
Power consumption	180 W
Power dissipation	<680 BTU/hour
Operating temperature	41°F to 95°F (+5°C to +35°C)
Storage temperature	14°F to 140°F (-10°C to +60°C)
Cabinet	Magnesium alloy (Terminal panel, Lamp cover and Side vent cover constructed of plastic)
I/R carrier frequency	38 kHz
Dimensions (approx.)	8 55/64" × 1 31/32" × 6 59/64" (225 (W) × 50 (H) × 176 (D) mm) (main body only) 8 55/64" × 2 19/32" × 6 31/32" (225 (W) × 66 (H) × 177 (D) mm) (including adjustment feet and projecting parts)
Weight (approx.)	3.5 lbs (1.6 kg)
Supplied accessories	Remote control, Two AAA size batteries, Power cord for U.S., Canada etc. (5' 11", 1.8 m), Power cord for Europe, except U.K. (5' 11", 1.8 m), Power cord for U.K., Hong Kong and Singapore (5' 11", 1.8 m), Power cord for Australia, New Zealand and Oceania (5' 11", 1.8 m), DVI-Analog to VGA cable (5' 11", 1.8 m), DVI-Analog to VGA adaptor, PC audio cable (6' 7", 2.0 m), DIN-D-sub RS-232C cable (6 1/2", 16.5 cm), Computer RGB cable (5' 11", 1.8 cm), USB mouse control cable (5' 11", 1.8 m), Video cable (5' 11", 1.8 m), S-video cable (5' 11", 1.8 m), AV audio cable (5' 11", 1.8 m), Soft carrying pouch, Lenscap with strap, CD-ROM, Projector operation manual, Projector quick reference guide
Replacement parts	Remote control (9HJ7583104001), AAA size battery (9HJ4683101001), Power cord for U.S., Canada etc. (9HJ4283114001), Power cord for Europe, except U.K. (9HJ4283116001), Power cord for U.K., Hong Kong and Singapore (9HJ4283117001), Power cord for Australia, New Zealand and Oceania (9HJ4283118001), DVI-Analog to VGA cable (9HJ4283119001), DVI-Analog to VGA adaptor (9HJ4283124001), PC audio cable (9HJ4283120001), DIN-D-sub RS-232C cable (9HJ4283123001), Computer RGB cable (9HJ4283111001), USB mouse control cable (9HJ4283122001), Video cable (9HJ4283112001), S-video cable (9HJ4283113001), AV audio cable (9HJ4283121001), Soft carrying pouch (9HJ5383101001), Lens cap with strap (9HJ7083117001), CD-ROM (9HJ3683104001), Projector operation manual (9HJ3683107001), Projector quick reference guide (9HJ3683110001)

This SHARP projector uses a DMD panel. This very sophisticated panel contains 786,432 (PG-M15X)/480,000 (PG-M15S) pixels. As with any high technology electronic equipment such as large screen TVs, video systems and video cameras, there are certain acceptable tolerances that the equipment must conform to.

This unit has some inactive pixels within acceptable tolerances which may result in inactive dots on the picture screen. This will not affect the picture quality or the life expectancy of the unit.

*Specifications are subject to change without notice.*





# Dimensions

Rear View

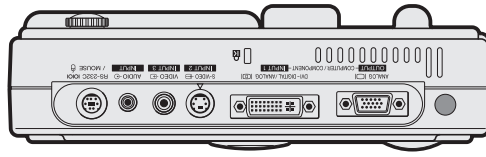

Top View

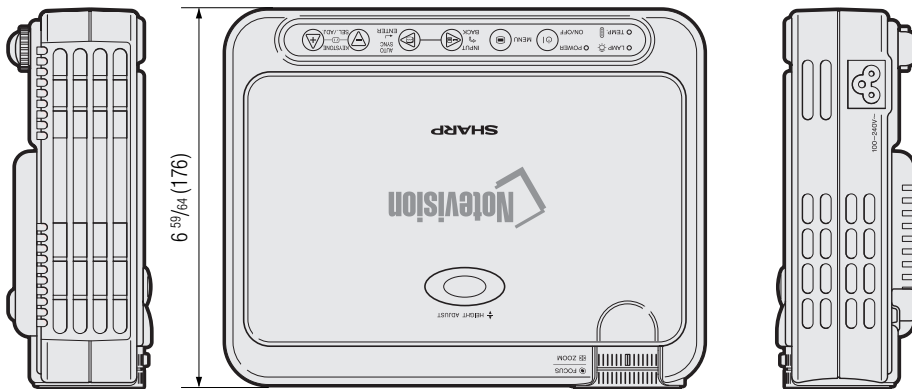

Side View

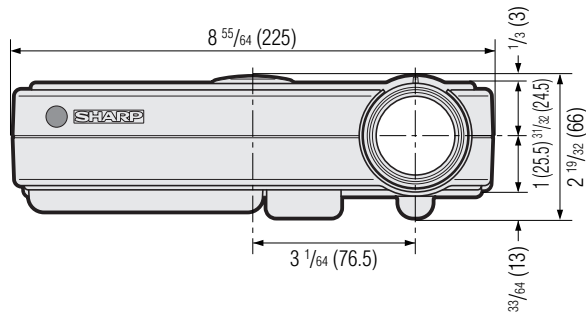

Front View

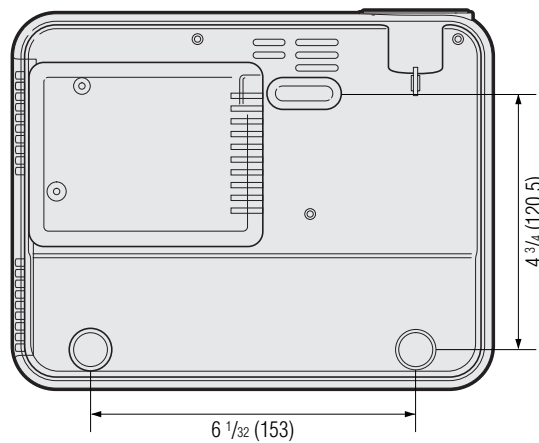

Bottom View

Units: inches (mm)





# Glossary

---

## **Anti-aliasing digital keystone correction**

Function to digitally correct a distorted image when the projector is set up at an angle.

## **Aspect ratio**

Width and height ratio of an image. The normal aspect ratio of a computer and video image is 4 : 3. There are also wide images with an aspect ratio of 16 : 9 and 21 : 9.

## **Auto sync**

Optimizes projected computer images by automatically adjusting certain characteristics.

## **Background**

Initial setting image projected when no signal is being input.

## **Clock**

Clock adjustment is used to adjust vertical noise when clock level is incorrect.

## **Compatibility**

Ability to use with various image signal modes.

## **Composite sync**

Signal combining horizontal and vertical sync pulses.

## **Dot by dot**

Mode that projects images in their native resolution.

## **DVI**

Digital Visual Interface that supports both digital and analog displays.

## **FREEZE**

Function to freeze a moving image.

## **GUI**

Graphical User Interface. User interface with graphics that allow easier operation.

## **Intelligent compression technology**

High quality resizing of lower and higher resolution images to fit the projector's native resolution.

## **Magnification**

Digitally zooms in on a portion of an image.

## **PDF**

Portable Document Format. Documentation format used to transfer text and images from the CD-ROM.

## **Phase**

Phase shift is a timing shift between isomorphic signals with the same resolution. When phase level is incorrect, the projected image typically displays horizontal flicker.

## **RESIZE**

Allows you to modify or customize the picture display mode to enhance the input image. You can select four different modes: NORMAL, DOT BY DOT, STRETCH and BORDER.

## **RS-232C**

Function to control the projector from the computer by using the RS-232C ports on the projector and computer.

## **SVGA resolution**

Resolution with 800 × 600 pixels that uses the signal of an IBM/AT compatible (DOS/V) computer.

## **Sync**

Synchronizes the resolution and phase shift of two signals. When receiving an image with a resolution different from that of the computer, the projected image may be distorted.

## **Sync on green**

Video signal mode of a computer which overlaps horizontal and vertical sync signal to green color signal pin.

## **Wireless mouse**

Function to operate the mouse control of a computer with the supplied remote control.

## **XGA resolution**

Resolution with 1,024 × 768 pixels that uses the signal of an IBM/AT compatible (DOS/V) computer.





# Index

<b>A</b>	
AC socket .....	13
Adjuster .....	22
ANALOG OUTPUT port .....	9
Aspect ratio .....	36
AUDIO INPUT terminal .....	9
Auto Power Off .....	42
Auto Source .....	43
Auto sync adjustment .....	33
AUTO SYNC button .....	33
AV audio cable .....	15
AV MUTE button .....	19
AV Mute Disp .....	40
<b>B</b>	
BACK button .....	27
Background .....	43
<b>C</b>	
Ceiling-mount .....	22
Ceiling + Rear .....	44
Clock .....	33
Computer RGB cable .....	14
Cooling fan (Exhaust vent) .....	9
<b>D</b>	
Digital image magnification .....	35
DIN-D-sub RS-232C cable .....	17
DVI-Analog to VGA adaptor .....	14
DVI-Analog to VGA cable .....	14
DVI-DIGITAL/ANALOG INPUT 1 port .....	9
<b>E</b>	
ENLARGE button .....	35
ENTER button .....	26
<b>F</b>	
Flip cover .....	10
FOCUS ring .....	9
FREEZE button .....	34
<b>G</b>	
GAMMA button .....	38
GUI (Graphical User Interface) .....	26
<b>H</b>	
HEIGHT ADJUST .....	22
<b>I</b>	
INPUT button .....	19
Intake vent .....	9
Intelligent compression technology .....	5
<b>K</b>	
Kensington Security Standard connector .....	48
KEYSTONE buttons .....	23
Keystone correction .....	23
<b>L</b>	
LAMP REPLACEMENT indicator .....	46
Lamp Timer .....	39
LEFT-CLICK button .....	25
<b>M</b>	
MENU button .....	26
MOUSE button .....	25
MOUSE port .....	24
<b>O</b>	
ON/OFF button .....	18
On-screen display language .....	30
OSD Display .....	41
<b>P</b>	
PC audio cable .....	13
PDF .....	8
Phase .....	33
Picture adjustments .....	31
POWER button .....	18
Power cord .....	13
POWER indicator .....	18
PRJ Mode .....	44
<b>R</b>	
Rear projection .....	22
Remote control .....	25
Remote control sensor .....	25
Remote control signal transmitter indicator .....	10
Remote control signal transmitting window .....	10
RESIZE button .....	36
RIGHT-CLICK button .....	25
RS-232C port .....	17
<b>S</b>	
SELECT/ADJUST buttons .....	26
Signal Info .....	39
Soft carrying pouch .....	49
Speaker .....	9
SVGA resolution .....	5
S-video cable .....	15
S-VIDEO INPUT 2 terminal .....	15
<b>T</b>	
TEMPERATURE WARNING indicator .....	46
<b>U</b>	
USB mouse control cable .....	24
<b>V</b>	
Video cable .....	15
VIDEO INPUT 3 terminal .....	15
VOLUME buttons .....	19
<b>W</b>	
Wireless mouse .....	25
<b>X</b>	
XGA resolution .....	5
<b>Z</b>	
ZOOM knob .....	19





# For SHARP Assistance

If you encounter any problems during setup or operation of this projector, first refer to the "Troubleshooting" section on page 48. If this operation manual does not answer your question, please contact the Service Department of your nearest SHARP Authorized Distributor.

<b>USA</b>	<b>Sharp Electronics Corporation</b> 1-888-GO-SHARP (1-888-467-4277) lcdsupport@sharpsec.com <a href="http://www.sharplcd.com">http://www.sharplcd.com</a>
<b>Canada</b>	<b>Sharp Electronics of Canada Ltd.</b> Sharp Customer Care Center (905) 568-7140 (Local) of 877-742-7722 (toll free) <a href="http://www.sharp.ca">http://www.sharp.ca</a>
<b>Mexico</b>	<b>Sharp Electronics Corporation Mexico Branch</b> Servicio al cliente llame: SHARP GENIAL Respuestas Inmediatas (525) 716-9000
<b>Germany</b>	<b>Sharp Electronics (Europe) GMBH</b> 01805-234675 <a href="http://www.sharp.de">http://www.sharp.de</a>
<b>U.K.</b>	<b>Sharp Electronics (U.K.) Ltd.</b> 0161-205-2333
<b>Italy</b>	<b>Sharp Electronics (Italy) S.P.A.</b> (39) 02-89595-1 (39) 02-89595-293 (Fax) <a href="http://www.sharp.it">http://www.sharp.it</a>
<b>Australia</b>	<b>Sharp Corporation of Australia Pty.Ltd.</b> 02-9830-4600 02-9672-1216 (Fax) <a href="http://www.sharp.net.au">http://www.sharp.net.au</a>
<b>New Zealand</b>	<b>Sharp Corporation of New Zealand</b> (09) 634-2059 (09) 636-6972 <a href="http://www.sharpnz.co.nz">http://www.sharpnz.co.nz</a>
<b>Singapore</b>	<b>Sharp-Roxy Sales (Singapore) Pte., Ltd.</b> 65-4294342 <a href="http://www.sharp.com.sg">http://www.sharp.com.sg</a> kwee@global.sharp.co.jp
<b>Malaysia</b>	<b>Sharp-Roxy Sales &amp; Service Co.</b> (M) Sdn. Bhd. No: 1A, Persiaran Kuala Langat, Section 27, 40400 Shan Alam, Selangor Arul Ehsan, Malaysia (60) 3-5125678 (60) 3-5154868 (Fax)
<b>U.A.E.</b>	<b>Sharp Middle East Fze</b> 971-4-81-5311 helpdesk@smef.global.sharp.co.jp
<b>Thailand</b>	<b>Sharp Thebnakorn Co., Ltd.</b> 02-236-0170 02-236-9188 (Fax) <a href="http://www.sharp-th.com">http://www.sharp-th.com</a>
<b>Korea</b>	<b>Sharp Electronics Incorporated of Korea</b> (82) 2-3660-2002 (82) 2-3660-2029 (Fax) <a href="http://www.sharp-korea.co.kr">http://www.sharp-korea.co.kr</a> webmaster@sharp-korea.co.kr



**SHARP CORPORATION**