

Dell™ Laser Printer 1100

Owner's Manual

Look Inside For:

- Preparing Your Printer
- Understanding Software
- Loading Print Media
- Printing
- Maintenance
- Troubleshooting



Order Toner Cartridges

Dell™ toner cartridges are available only through Dell. You can order toner cartridges online at www.dell.com/supplies or by phone.

USA	877-INK-2-YOU
Australia	1300 303 290
Austria	08 20 - 24 05 30 35
Belgium	02.713 1590
Canada	877-501-4803
Chile	800-202874
	1230-020-3947
China	800-858-2425
Colombia	01800-9-155676
Czech	420 225 372 711
Denmark	3287 5215
Finland	09 2533 1411
France	0825387247
Germany	0800 2873355
Ireland	1850 707 407
Italy	800602705
Japan	044-556-3551
Luxembourg	02.713 1590
Malaysia	1800 88 0553
Mexico	866-851-1754
Netherlands	020 - 674 4881
Norway	231622 64
Portugal	21 4220710
Puerto Rico	866-851-1760
Singapore	1800 394 7425
South Africa	0860 102 591
Spain	902120385
Sweden	08 587 705 81
Switzerland	0848 335 599
UK	0870 907 4574



NOTE: *If your country is not listed, contact your Dell distributor to order supplies.*

Toner Cartridge	Part Number
2,000 page toner	J9833

Understanding the Printer

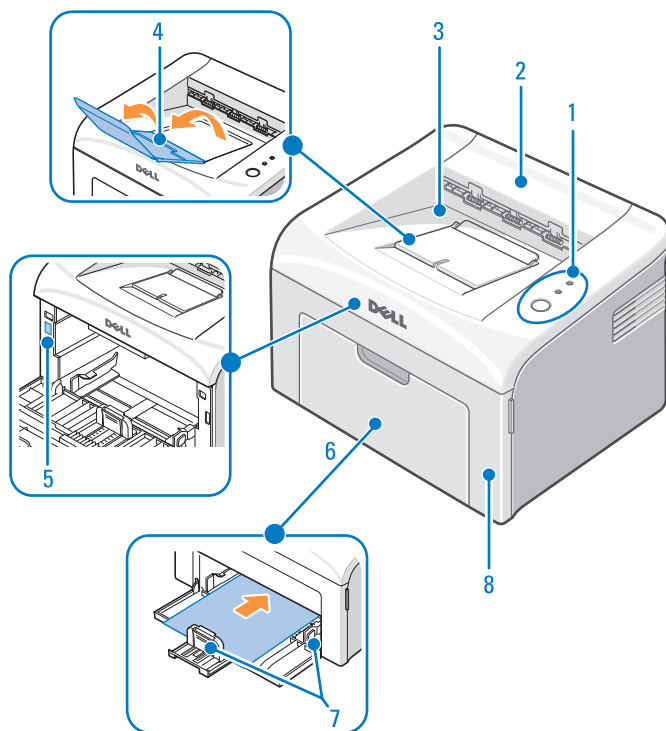

#	Use the:	When you want to:
1	Operator Panel	Operate the printer and check the status of your printer.
2	Top Cover	Open to remove the paper jams.
3	Paper Output Tray	Stack printed document face down.
4	Paper Output Extension	Keep print media from falling off the paper output tray.
5	Express Service Code	Identify your printer when you use support.dell.com or contact technical support. Enter the Express Service Code to direct your call when contacting technical support. The Express Service Code is not available in all countries.
6	Paper Input Tray	Load up to 150 sheets of paper or other media, or a single sheet of paper or other media.
7	Paper Guides	Adjust the length and width of the media in the paper input tray.
8	Front Cover	Access the toner cartridge.

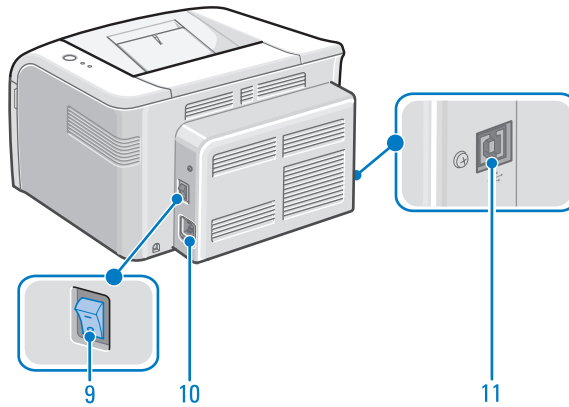

#	Use the:	When you want to:
9	Power Switch	Power your printer on or off.
10	Power Cord Connector	Plug your printer into a properly grounded electrical outlet with the power cord (after all peripherals have been connected).
11	USB Cable Connector	Insert the USB cable.

Accessing Your *User's Guide*

To access your *User's Guide*, click Start → Programs → Dell Printers → Dell Laser Printer 1100 → User's Guide.

Notes, Notices, and Cautions



NOTE: A **NOTE** indicates important information that helps you make better use of your printer.



NOTICE: A **NOTICE** indicates either potential damage to hardware or loss of data and tells you how to avoid the problem.



CAUTION: A **CAUTION** indicates a potential for property damage, personal injury, or death.

Information in this document is subject to change without notice.

© 2005 Dell Inc.. All rights reserved.

Reproduction in any manner whatsoever without the written permission of Dell Inc. is strictly forbidden.

Trademarks used in this text: *Dell*, *DELL* logo, and *Dell Toner Management System* are trademarks of Dell Inc.; *Microsoft* and *Windows* are registered trademarks of Microsoft Corporation.

Adobe is a registered trademark of Adobe Systems Incorporated.

Other trademarks and trade names may be used in this document to refer to either the entities claiming the marks or the names of their products. Dell Inc. disclaims any proprietary interest in trademarks and trade names other than its own.

Contents

Understanding the Printer	iii
Accessing Your <i>User's Guide</i>	iv
CAUTION: SAFETY INFORMATION.	1
WAARSCHUWING: VEILIGHEIDSINFORMATIE	2
FORSIGTIG: Sikkerhedsoplysninger	3
VAROITUS: TURVALLISUUSTIEDOT	4
FORSIKTIG: SIKKERHETSINFORMASJON	5
VARNING: säkerhetsinformation	6
ПРЕДУПРЕЖДЕНИЕ: ИНФОРМАЦИЯ О БЕЗОПАСНОСТИ	7
DİKKAT: Güvenlik bilgileri	9
CUIDADO: INFORMAÇÃO DE SEGURANÇA.	10
UPOZORNĚNÍ: BEZPEČNOSTNÍ INFORMACE	11
PRZESTROGA: INFORMACJE O BEZPIECZEŃSTWIE	12
1 Preparing Your Printer	
Setting Up the Printer	13
Using the Operator Panel	13
2 Understanding Software	
Software Overview	15
Installing Dell Software	15
Uninstalling Dell Software	16

3	Loading Print Media	
	Print Media Guidelines	17
	Pint Media Types, Sizes, and Support	17
	Loading Paper in the Paper Tray.	19
	Loading Paper Using Manual Feed Mode.	21
	Loading Special Materials.	22
4	Printing	
	Basic Printing	25
	Accessing Printer Properties	25
	Setting High Altitude Correction	25
	Sharing Your Printer Locally.	26
	In Windows 98/Me	26
	In Windows 2000/XP	27
5	Maintenance	
	Ordering Supplies	29
	Replacing the Toner Cartridge.	30
	Cleaning Your Printer	33
	Cleaning the Exterior	33
	Cleaning the Interior	33
6	Troubleshooting	
	Clearing Jams in the Paper Tray.	35
	Paper Feed Jam.	35
	Paper Exit Jam	36
	Fuser Area Jam	38
	Tips for Avoiding Paper Jams.	39
	Understanding the Operator Panel LEDs	40
	LED Status Legend	40
	More Troubleshooting	41

7	Contacting Dell	
	Technical Assistance	43
	Automated Order-Status Service	44
	Contacting Dell	44
8	Appendix	
	U.S Terms and Conditions of Sales	61
	Limited Warranties and Return Policy	65
	Limited Warranty for Dell-Branded Hardware Products (U.S. Only).	65
	Total Satisfaction Return Policy (U.S. Only)	68
	Limited Warranty Terms for Dell-Branded Hardware Products (Canada Only).	69
	Total Satisfaction Return Policy (Canada Only)	72
	Dell™ Software and Peripherals (Canada Only).	73
	1-Year End-User Manufacturer Guarantee (Latin America and the Caribbean Only)	73
	Dell Inc.	
	Ink and Toner Cartridges Limited Warranties	75
	Ink and Toner Cartridges Limited Warranty (U.S. and Canada Only)	75
	Ink and Toner Cartridges Limited Warranty (Latin America Only)	76
	Dette skema er alene anvendeligt for norske konsumenter	77
	ANGREFRISTSKJEMA	77
	Generelle betingelser for retur:	77
	Regulatory Notices	78
	FCC Notices (U.S. Only).	79
	NOM Information (Mexico Only)	80
	Export Regulations	80
	Dell™ Software License Agreement	81
	Limited Warranty	82
	U.S. Government Restricted Rights	82
	General	83

CAUTION: SAFETY INFORMATION

Use the following safety guidelines to help ensure your own personal safety and to help protect your system and working environment from potential damage.

- This printer is certified as a "Class 1" laser product under the U.S. Department of Health and Human Services (DHHS) Radiation Performance Standard according to the Radiation control for Health and Safety Act of 1968.

Since radiation emitted inside the printer is confined within protective housings and external covers, the laser beam cannot escape during normal user operation.

CAUTION: Use of controls or adjustments or performance of procedures other than those specified herein may result in hazardous radiation exposure.

- Your product uses a printing process that heats the print media, and heat can cause certain media to release emissions. You must understand the section in your operating instructions that discusses the guidelines for selecting appropriate print media to avoid the possibility of harmful emissions.

CAUTION: If your product is not marked with this symbol , it must be connected to an electrical outlet that is properly grounded.

- The power cord must be connected to an electrical outlet that is near the product and easily accessible.
- Refer service or repairs, other than those described in the operating instructions, to a professional service person.
- This product is designed to meet safety standards with the use of specific Dell-authorized components. The safety features of some parts may not always be obvious. Dell disclaims liability associated with use of non-Dell-authorized components.

CAUTION: Do not use this product during a lightning storm.

WAARSCHUWING: VEILIGHEIDSINFORMATIE

Volg de onderstaande veiligheidsrichtlijnen om uw persoonlijke veiligheid te garanderen en uw systeem en werkomgeving tegen mogelijke schade te beschermen.

- Deze printer is gecertificeerd als een "Klasse 1" laserproduct volgens de stralingsnorm gehanteerd door het Amerikaanse Department van Gezondheid en Welzijn (DHHS: Department of Health and Human Services) en zoals opgenomen in de Amerikaanse wet op stralingsbescherming voor gezondheid en veiligheid uit 1968.
- Omdat de straling die in de printer optreedt, opgesloten zit in beschermende behuizingen en externe kappen, kan de laserstraal niet vrijkomen tijdens normaal gebruik.

 **WAARSCHUWING: Het gebruik van sturingen of instellingen of het uitvoeren van procedures die afwijken van deze hier vermeld kan resulteren in gevaarlijke blootstelling aan straling.**

- Uw product maakt gebruik van een afdrukproces dat de afdrukmedia verhit, en de hitte kan bij sommige media aanleiding geven tot emissies. U moet de passage in uw bedieningsinstructies begrijpen dat handelt over de richtlijnen inzake het selecteren van geschikte afdrukmedia om de mogelijkheid van schadelijke emissies te vermijden.

 **WAARSCHUWING: Als uw product niet gemarkeerd is met dit symbool , dan moet u het aansluiten op een stopcontact met correcte aarding.**

- Plug de stekker van het netsnoer in een stopcontact dat zich in de nabijheid van het product bevindt en makkelijk toegankelijk is.
- Laat onderhoud of reparaties die afwijken van deze beschreven in de bedieningsinstructies over aan gekwalificeerd onderhoudspersoneel.
- Dit product is ontworpen om aan de veiligheidsnormen te voldoen met behulp van specifieke componenten die door de Dell zijn goedgekeurd. De veiligheidseigenschappen van sommige onderdelen zijn niet altijd vanzelfsprekend. Dell kan niet verantwoordelijk worden gesteld in geval van gebruik van componenten die niet door Dell zijn goedgekeurd.

 **WAARSCHUWING: Gebruik dit product niet tijdens een onweer.**



FORSIGTIG: Sikkerhedsoplysninger

Brug følgende sikkerhedsvejledning til at sikre din egen personlige sikkerhed og til at beskytte dit arbejdsområde mod eventuelle skader.

- Printeren er certificeret som laserprodukt i klasse 1 under USA's Department of Health and Human Services (DHHS) Radiation Performance Standard i henhold til Radiation control for Health and Safety Act of 1968.
- Da stråling, der udsendes inden i printeren, holdes inde af beskyttende afdækning og udvendige dæksler, kan laserstrålen ikke slippe ud ved normal brug.

 **FORSIGTIG: Anvendelse af kontrolfunktioner eller justering eller udførelse af procedurer, der ikke er angivet i denne manual, kan resultere i farlig bestråling.**

- Printeren bruger en udskrivningsproces, hvorved udskrivningsmediet opvarmes, og varmen kan medføre, at visse medier frigiver stråler. Du skal forstå afsnittet i betjeningsvejledningen, der beskriver, hvordan egnede udskriftmedier vælges, så risikoen for farlig bestråling undgås.

 **FORSIGTIG: Hvis din printer ikke er mærket med dette symbol , skal den tilsluttes et elektrisk stik, som er jordet.**

- Ledningen skal sættes i et elektrisk stik, som er i nærheden af printeren, og som er let at komme til.
- Service eller reparation, som ikke er beskrevet i betjeningsvejledningen, skal udføres af en uddannet servicerepræsentant.
- Denne printer er udviklet, så den opfylder sikkerhedsstandarderne med brug af særlige Dell-autoriserede komponenter. Sikkerhedsfunktionerne i nogle dele er ikke altid synlige. Dell fraskriver sig ansvaret i forbindelse med brugen af ikke-Dell-autoriserede komponenter.

 **FORSIGTIG: Printeren må ikke benyttes i tordenvejr.**

VAROITUS: TURVALLISUUSTIEDOT

Toimi seuraavien turvaohjeiden mukaan oman turvallisuutesi varmistamiseksi ja välttääksesi järjestelmän ja työympäristön mahdollisen vahingoittumisen.

- Tämä tulostin on luokiteltu "Luokan 1" laserlaitteeksi DHHS:n säteilystandardin (Department of Health and Human Services Radiation Performance Standard) mukaisesti Yhdysvaltain säteilyn rajoitusta koskevaa lainsäädäntöä (Radiation control for Health and Safety Act, 1968) noudattaen.
- Koska tulostimen sisällä syntyvä säteily jää suojakotelon ja kansien sisälle, lasersäteitä ei pääse ulos normaalin käytön yhteydessä.

VAROITUS: Laitteen käyttö tai säätö muulla kuin tässä käyttöoppaassa mainitulla tavalla saattaa altistaa vaaralliselle säteilylle.

- Tulostimessa käytetään tulostusprosessia, joka kuumentaa tulostusmateriaalia, ja lämpö aiheuttaa päästöjä joillain materiaaleilla. Sinun on ymmärrettävä käyttöoppaan osa, jossa kuvataan sopivien tulostusmateriaalien valinta, mahdollisten haitallisten päästöjen välttämiseksi.

VAROITUS: Jos laitteessa ei ole symbolia , se on kytkettävä asianmukaisesti maadoitettuun pistorasiaan.

- Virtajohto on liitettävä pistorasiaan, joka on lähellä laitetta ja johon pääsee helposti käsiksi.
- Jätä muut kuin käyttöoppaassa kuvatut huolto- ja korjaustoimet ammattilaisille.
- Tämä laite on suunniteltu täyttämään turvallisuusstandardit, kun sitä käytetään yhdessä Dellin hyväksymien komponenttien kanssa. Joidenkin turvallisuusominaisuudet eivät välttämättä ole itsestään selviä. Dell kiistää vastuun muiden kuin Dellin hyväksymien komponenttien käytöstä.

VAROITUS: Älä käytä tätä laitetta ukonilman aikana.



FORSIKTIG: SIKKERHETSINFORMASJON

Ved å følge retningslinjene for sikkerhet nedenfor trygger du din egen personlige sikkerhet i tillegg til at du bidrar til å beskytte systemet og arbeidsmiljøet mot mulig skade.

- Skriveren er sertifisert som et laserprodukt i "Class 1" ifølge U.S. Department of Health and Human Services (DHHS) Radiation Performance Standard, basert på "Radiation control for Health and Safety Act" fra 1968.
- Siden strålingen som avgis inne i skriveren er avgrenset av et beskyttende kabinett og ytre deksler, kan ikke laserstrålen unnslippe under vanlig bruk av skriveren.

 **FORSIKTIG: Bruk av anordninger eller justeringer eller utførelse av andre prosedyrer enn de som er beskrevet her, kan føre til at det avgis farlig stråling.**

- Produktet anvender en utskriftsprosess der utskriftsmediet blir varmet opp, og varmen kan føre til at visse utskriftsmedier avgir utslipp. Du må være fortrolig med den delen av bruksanvisningen der disse retningslinjene blir omtalt for å kunne velge egnede utskriftsmedier og dermed unngå muligheten for skadelige utslipp.

 **FORSIKTIG: Hvis produktene ikke er merket med symbolet , må det kobles til et strømuttak som er forsvarlig jordet.**

- Strømledningen må kobles til et strømuttak som befinner seg i nærheten av produktet og som er lett tilgjengelig.
- Overlat andre former for service og reparasjoner enn det som er beskrevet i bruksanvisningen, til en profesjonell servicetekniker.
- Dette produktet er konstruert for å oppfylle sikkerhetsstandardene ved bruk av bestemte komponenter som er godkjent av Dell. Sikkerhetsfunksjonene ved noen deler er ikke alltid åpenbar. Dell fraskriver seg ansvar knyttet til bruk av komponenter som ikke er godkjent av Dell.

 **FORSIKTIG: Dette produktet skal ikke brukes i tordenvær.**

VARNING: säkerhetsinformation

Följ anvisningarna här nedan för att skydda dig själv, systemet och arbetsmiljön mot skador.

- Skrivaren har certifierats vara en laserprodukt av klass 1 enligt den amerikanska standarden Department of Health and Human Services (DHHS) Radiation Performance Standard, i enlighet med statuten Radiation control for Health and Safety Act från 1968.
- Eftersom strålningen som släpps ut i skrivaren inte tränger ut genom skyddskåporna och de externa luckorna, går laserstrålen inte att komma åt under normala omständigheter.

 **VARNING: Kontroller, justeringar eller procedurer annat än de som beskrivs här kan leda till farlig bestrålning.**

- Skrivarens utskriftsprocess innebär att utskriftsmediet värms upp, och det kan göra att ämnen frigörs från det. Läs och ta till dig det avsnitt i handboken där det finns riktlinjer om hur du väljer lämpliga utskriftsmedier för att slippa att skadliga ämnen frigörs.

 **VARNING: Om produkten inte är märkt med symbolen , måste den anslutas till ett jordat vägguttag.**

- Nätsladden måste anslutas till ett uttag nära intill skrivaren, och det ska vara lätt att komma åt.
- Låt någon yrkeskunnig sköta all service och alla reparationer utöver de som beskrivs i handboken.
- Produkten uppfyller tillämpliga säkerhetsföreskrifter om enbart de komponenter som Dell har godkänt används. Det kan vara svårt att avgöra om vissa reservdelar är säkra. Dell frånsäger sig allt ansvar för skador som uppkommer på grund av att du använder komponenter som Dell inte har godkänt.

 **VARNING: Använd inte produkten när det åskar.**



ПРЕДУПРЕЖДЕНИЕ: ИНФОРМАЦИЯ О БЕЗОПАСНОСТИ

Следуйте приведенным ниже указаниям по мерам безопасности, чтобы обеспечить Вашу личную безопасность и избежать возможных повреждений Вашего оборудования.

- Данный принтер сертифицирован как лазерный продукт класса 1 по стандарту на уровни излучения Министерства здравоохранения и социального обеспечения США, разработанному в соответствии с Законом о контроле над радиацией в интересах здравоохранения и безопасности 1968 г.
- Поскольку излучение, создаваемое внутри принтера, полностью закрыто защитными кожухами и внешними крышками, лазерный пучок ни при каких условиях не может выйти из принтера наружу.

 **ПРЕДУПРЕЖДЕНИЕ: Использование элементов управления и настроек или выполнение операций, не описанных в настоящем руководстве, может привести к опасному радиационному облучению.**

- В процессе печати принтер нагревает носитель. В результате нагрева некоторые носители могут выделять различные вещества. Внимательно прочитайте раздел Руководства, посвященный выбору носителя, чтобы избежать возможного выделения вредных веществ.

 **ПРЕДУПРЕЖДЕНИЕ: Если на устройстве нет значка , его необходимо подключать к электрической розетке с заземлением.**

- Шнур питания нужно подключать к удобно расположенной электрической розетке рядом с устройством.
- Работы по обслуживанию и ремонту, не описанные в Руководстве пользовател, следует поручать квалифицированному специалисту.
- Этот продукт удовлетворяет всем стандартам по безопасности при условии использования компонентов, сертифицированных Dell. Необходимые меры по обеспечению безопасности при использовании некоторых деталей могут быть неочевидны. Dell не принимает на себя ответственность за использование компонентов, не сертифицированных Dell.

 **ПРЕДУПРЕЖДЕНИЕ: Не пользуйтесь данным устройством во время грозы.**

⚠️ تحذير: معلومات الأمان

استخدم توجيهات الأمان التالية للاطمئنان على سلامتك الشخصية ولحماية النظام وبيئة التشغيل من أي ضرر محتمل.

- تم ترخيص هذه الطابعة باعتبارها منتج ليزر من "الفئة 1" بناءً على معيار الأداء الإشعاعي لوزارة الصحة والخدمات البشرية (DHHS) في الولايات المتحدة بموجب قانون السيطرة على الإشعاعات من أجل الصحة والسلامة لعام 1968.
- ولأنه يتم احتواء الإشعاع المنبعث داخل الطابعة داخل إطارات التثبيت الوقائية للطابعة والأغطية الخارجية، لا يمكن لحزمة الليزر النفاذ إلى الخارج خلال عمليات التشغيل العادية التي يقوم بها المستخدم.

⚠️ تحذير: قد يترتب على استخدام عناصر تحكم أو ضبط أو تنفيذ إجراءات غير تلك المحددة في هذا المستند التعرض لنسبة خطيرة من الإشعاع.

- يعتمد المنتج الذي بين يديك على نوع من عمليات الطابعة يتسبب في ارتفاع درجة حرارة وسائط الطابعة مما قد يترتب عليه تحرر بعض الإشعاعات من وسائط معينة. يجب عليك استيعاب المعلومات الموجودة في القسم المتوفر في إرشادات التشغيل والذي يتناول توجيهات اختيار وسائط الطابعة المناسبة لتجنب أية إشعاعات ضارة محتملة.

⚠️ تحذير: إذا كان المنتج المتوفر بين يديك لا يحمل العلامة ، فهذا يعني أنه من الضروري توصيله بأخذ تيار كهربائي متصل بطرف أرضي بشكل مناسب.

- يجب توصيل سلك الطاقة بأخذ تيار كهربائي قريب من المنتج ويسهل الوصول إليه.
- عند الرغبة في إجراء عمليات خدمة أو إصلاح غير تلك المذكورة في إرشادات التشغيل، يرجى الرجوع إلى مسؤول الصيانة المتخصص.
- تم تصميم هذا المنتج لاستيفاء معايير الأمان باستخدام مكونات معينة مرخصة من شركة Dell. قد لا تكون مزايا الأمان لبعض الأجزاء واضحة. وتخلي شركة Dell مسئوليتها بالنسبة لاستخدام أية مكونات غير مرخصة من شركة Dell.

⚠️ تحذير: لا تستخدم هذا المنتج خلال العواصف الرعدية.

DİKKAT: Güvenlik bilgileri

Kişisel güvenliğinizi sağlamak ve aynı zamanda sisteminizi ve çalışma ortamınızı muhtemel arıza ve hasarlardan korumak için aşağıdaki emniyet kurallarına uyun.

- A.B.D. Sağlık ve İnsan Hizmetleri Bakanlığının (DHHS) 1968 yılında yürürlüğe giren Sağlık ve Güvenlik için Radyasyon kontrolü kanununa göre, bu yazıcı bir "Class 1" lazer ürünü olarak onaylanmıştır.
- Normal kullanım sırasında yazıcının içerisinden yayımlanan radyasyon, koruyucu muhafazalar ve dış kapakla kapatıldığından lazer ışınıyla doğrudan temas mümkün değildir.

 **DİKKAT: Burada belirtilenden farklı şekilde kontrollerin, ayarlamaların veya kullanım prosedürlerinin uygulanması kişilerin tehlikeli radyasyona maruz kalmasına neden olabilir.**

- Ürününüz yazdırma malzemesini ısıtan bir yazdırma işlemi uygulamaktadır. Bu ısı bazı yazdırma malzemelerinin çeşitli emisyonlar yaymasına neden olabilir. Zararlı emisyonların önlenmesi için kullanım talimatlarınızda bulunan yazdırma malzemelerinin seçilmesi ile ilgili bölümü iyi şekilde anlamanız gerekir.

 **DİKKAT: Ürününüz bu simge  ile işaretli değilse, uygun şekilde topraklanmış bir prize takılması gerekir.**

- Elektrik kablosu ürünün yanında bulunan ve kolay erişilebilir bir prize takılmalıdır..
- Kullanım talimatlarında belirtilenlerin dışındaki bakım ve onarımlar için profesyonel bir servis personeline başvurun.
- Bu ürün, Dell tarafından onaylanmış belli parçaların kullanımıyla güvenlik standartlarını karşılamak üzere tasarlanmıştır. Bazı parçaların güvenlik özellikleri her zaman çok açık değildir. Dell tarafından onaylanmamış parçaların kullanımı sonucu ortaya çıkabilecek durumlarda Dell sorumluluk kabul etmez.

 **DİKKAT: Bu ürünü fırtınalı günlerde kullanmayın.**

CUIDADO: INFORMAÇÃO DE SEGURANÇA

Siga as orientações de segurança abaixo para o ajudar a garantir a sua segurança pessoal e a proteger o sistema e ambiente de trabalho contra danos potenciais.

- Esta impressora está certificada como produto laser de "Classe 1", segundo a norma Radiation Performance (Desempenho das radiações) do U.S. Department of Health and Human Services (DHHS - Departamento de saúde e serviços humanos dos Estados Unidos), em conformidade com o controlo de radiação da Health and Safety Act (Lei sobre saúde e segurança) de 1968.
- Como a radiação emitida no interior da impressora fica limitada às estruturas de protecção e tampas externas, o raio laser não sai da máquina durante o seu funcionamento normal.

 **CUIDADO: A utilização de controlos ou os ajustes, ou mesmo a execução de procedimentos não especificados neste manual, podem resultar em exposição perigosa a radiações.**

- A sua máquina utiliza um processo para imprimir que aquece o material de impressão; o calor pode fazer com que o material de impressão produza emissões. Tem de compreender a secção das instruções que descreve as orientações para escolher o material de impressão adequado e para evitar a ocorrência de emissões prejudiciais à saúde.

 **CUIDADO: Se a sua máquina não tiver o símbolo , tem de ser ligada a uma tomada com ligação à terra.**

- O cabo de alimentação tem de ser ligado a uma tomada que esteja perto da máquina e seja de fácil acesso.
- A operações de manutenção e reparação que não estejam descritas nas instruções devem ser efectuadas por um técnico profissional.
- Esta máquina foi concebida para respeitar as normas de segurança, utilizando componentes específicos autorizados pela Dell. As funções de segurança de algumas peças podem nem sempre ser evidentes. A Dell não se responsabiliza pela utilização de componentes não autorizados pela Dell.

 **CUIDADO: Não utilize esta máquina em caso de trovoadas.**

UPOZORNĚNÍ: BEZPEČNOSTNÍ INFORMACE

Následující bezpečnostní pokyny vám pomohou zajistit vlastní osobní bezpečnost a chránit vaše zařízení a pracovní prostředí před možným poškozením.

- Tato tiskárna je klasifikována jako laserové zařízení "třídy 1" podle normy pro vyzařování vydané Ministerstvem zdravotnictví a veřejných služeb USA v souladu s kontrolou záření pro Zákon o zdraví a bezpečnosti z r. 1968.
- Protože záření vyzařované uvnitř tiskárny je uzavřeno ochrannými pouzdry a vnějšími kryty, laserový paprsek nemůže uniknout při normálním uživatelském provozu.

UPOZORNĚNÍ: Používání jiných ovládacích prvků nebo nastavení, nebo provádění jiných postupů než těch, které jsou uvedeny v této příručce, může způsobit vystavení nebezpečnému záření.

- Vaše zařízení používá tiskový proces, který zahřívá tisková média, a vysoká teplota může způsobit, že určitá média budou uvolňovat emise. Musíte si podrobně nastudovat kapitulu v návodu k obsluze, kde jsou pokyny pro výběr správných tiskových médií, aby se předešlo možným škodlivým emisím.

UPOZORNĚNÍ: Jestliže vaše zařízení není označeno tímto symbolem , musí být připojeno k elektrické zásuvce, která je řádně uzemněna.

- Přívodní šňůra musí být zapojena do elektrické zásuvky, která je blízko zařízení a je snadno přístupná.
- Opravářské a údržbové práce, které nejsou popsány v návodu k obsluze, přenechte profesionálnímu servisnímu technikovi.
- Tento výrobek je zkonstruován tak, aby splňoval bezpečnostní normy při použití konkrétních komponentů autorizovaných společností Dell. Bezpečnostní charakteristiky některých dílů nemusí být vždy zřejmé. Společnost Dell nepřebírá odpovědnost spojenou s použitím komponentů, které nejsou společností Dell autorizovány.

UPOZORNĚNÍ: Nepoužívejte toto zařízení při bouřce.

PRZESTROGA: INFORMACJE O BEZPIECZEŃSTWIE

Aby zapewnić sobie bezpieczeństwo osobiste oraz uchronić system i środowisko pracy przed potencjalnymi uszkodzeniami, należy przestrzegać poniższych wskazań dotyczących bezpieczeństwa.

- Niniejsza drukarka uzyskała certyfikat produktu laserowego pierwszej klasy w rozumieniu normy Radiation Performance Standard amerykańskiego Departamentu Zdrowia i Usług Obywatelskich (DHHS), zgodnie z ustawą o kontroli promieniowania dla celów zdrowotnych i bezpieczeństwa (Radiation control for Health and Safety Act) z roku 1968.
- Ponieważ promieniowanie emitowane we wnętrzu drukarki jest ograniczone osłonami ochronnymi i zewnętrzną obudową, w trakcie normalnego użytkowania promień lasera nie powinien wydostać się na zewnątrz.

 **PRZESTROGA: Regulacja i dopasowywanie urządzenia oraz postępowanie według procedur innych niż wskazane w niniejszym dokumencie mogą narazić użytkownika na kontakt z niebezpieczną dawką promieniowania.**

- Drukarka w procesie druku nagrzewa materiał do drukowania, a wydzielane ciepło może spowodować emitowanie promieniowania przez niektóre materiały. Aby uniknąć ryzyka emitowania szkodliwego promieniowania należy zapoznać się z sekcją w instrukcji obsługi omawiającą dobór odpowiednich materiałów do drukowania.

 **PRZESTROGA: Jeśli drukarka nie jest oznaczona symbolem , musi zostać podłączona do prawidłowo uziemionego źródła zasilania.**

- Kabel zasilania powinien zostać podłączony do gniazda sieci elektrycznej, znajdującego się w pobliżu drukarki i łatwo dostępnego.
- Serwisowanie i naprawy urządzenia inne niż opisane w instrukcji obsługi powinny być powierzane kompetentnemu serwisantowi.
- Drukarka została zaprojektowana w sposób spełniający standardy bezpieczeństwa przy założeniu używania określonych elementów firmy Dell. Zabezpieczenia niektórych części mogą nie być oczywiste. Firma Dell wyłącza odpowiedzialność związaną z używaniem elementów przez nią niezatwierdzonych.

 **PRZESTROGA: Drukarki nie należy używać w czasie burzy.**

Preparing Your Printer

Setting Up the Printer



If you have not already done so, follow the steps on the *Setup Diagram* (poster) to complete the hardware and software installation.

Using the Operator Panel

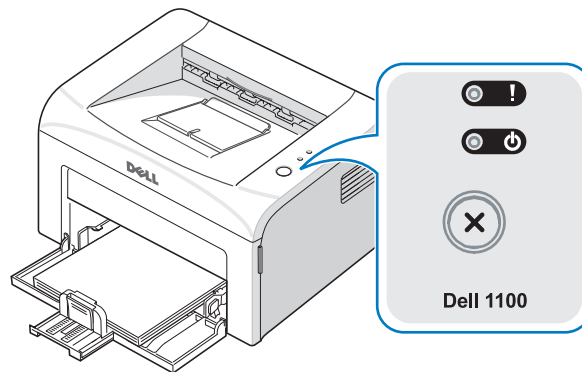





The operator panel on the top right side of your printer has two LEDs and one button.



LEDs

LED	Description
	The operator panel LEDs signify different things, depending on their sequence. LEDs that are off, on, and/or blinking indicate printer conditions, such as printer status, intervention (for example, out of paper and jammed paper), or service. For more information on what the LEDs sequence means and what you can do, see “Understanding the Operator Panel LEDs” on page 40.
	

Button

Item	Description
To print a demo page	In Ready mode, press and hold  for 2 seconds until both LEDs blink slowly, and release.
Manual feeding	Press  each time you load a sheet of paper in the tray, when you select Manual Feed for Source from your software application. For detailed information, see “Loading Paper Using Manual Feed Mode” on page 21.
To cancel a print job	Press  during printing.  blinks red while the print job is cleared from both the printer and the computer, and the printer then returns to Ready mode. This may take some time depending on the size of the print job. In Manual Feed mode, you can't cancel the print job by pressing  .
Manual Duplex feeding	Press  each time you load the paper back in the tray after the first side of your job has printed while manual duplex printing. For detailed information, see the <i>HTML User's Guide</i> .

Understanding Software

Software Overview

After setting up your printer and connecting it to your computer, you must install the drivers and utilities from the *Drivers and Utilities* CD included with your printer. If you purchased a Dell™ computer and your printer at the same time, the drivers and utilities are automatically installed. You don't need to install them. The *Drivers and Utilities* CD contains the following:

- Dell Printer Driver— allows your computer to communicate with your printer. To use your printer as a printer in Windows, you must install the printer driver. For information about installing the printer driver in Windows, see page 15.
- Dell Toner Management System™— displays the status of the printer and the name of the job when you send a job to print. The Dell Toner Management System™ window also displays the level of toner remaining and allows you to order replacement toner cartridges.
- User's Guide— HTML documentation provides detailed information about using your printer.

Installing Dell Software

A printer driver is software that lets your computer communicate with your printer. The procedure to install drivers depends on the operating system you are using.



NOTE: If you attach a USB printer cable while your printer and computer are powered on, the Windows hardware wizard launches immediately. Cancel the screen and use the *Drivers and Utilities* CD to install the Dell software.

- 1 Make sure that the printer is connected to your computer and powered on. Close all unnecessary programs.



NOTE: If the printer is not connected to your computer when you install the CD-ROM, the No Printer Found screen appears. Follow the instructions to install the software.

- 2 Insert the *Drivers and Utilities* CD.
- 3 *If necessary*, select a language by pressing the **Language** button on the main screen.
- 4 Select **Typical Installation** to install the *User's Guide*, the printer driver, and Dell Toner Management System™ as the default settings.

To choose an individual component to install, select **Custom Installation**. You can also change the destination folder.

- 5 When the installation has been completed, you may print a test page. Click **Finish** to complete the installation and close the wizard. You are now ready to print.

Uninstalling Dell Software

You should remove the printer driver *if you are upgrading the software or if your driver installation fails*. You can remove the software using the *Drivers and Utilities* CD or the Windows uninstall.



NOTE: Close all programs before uninstalling software.

- 1 From the **Start** menu, select **Programs** → **Dell Printers** → **Dell Laser Printer 1100** → **Dell Printer Software uninstall**.
- 2 Select the software you want to remove and click **Next**.
The selected driver and all of its components are removed from your computer.
- 3 Click **Finish**.

Loading Print Media

Print Media Guidelines

Printer media includes paper, card stock, transparencies, labels, and envelopes. Your printer provides high quality printing on a variety of print media. Selecting the appropriate print media for your printer helps you avoid printing problems. To get the best possible print quality, use only high-quality, copier-grade paper.

The following table provides information on the input source, including the print media types and sizes you can select and supported weights.

Print Media Types, Sizes, and Support

Paper	Dimensions ^a	Weight	Capacity ^b
Plain Paper			
Letter	8.5 x 11 in. (216 x 279 mm)		
A4	8.27 x 11.7 in. (210 x 297 mm)		
A5	5.83 x 8.27 in. (148 x 210 mm)		
Executive	7.25 x 10.5 in. (184.2 x 266.7 mm)	<ul style="list-style-type: none"> • 60 to 90 g/m² bond (16 to 24 lb) for the paper tray • 60 to 165 g/m² bond (16 to 43 lb) for manual feed mode • 150 sheets of 75 g/m² bond (20 lb) paper for the paper tray • 1 sheet of paper for manual feed mode 	
Legal	8.5 x 14 in. (215.9 x 355.6 mm)		
JIS B5	7.17 x 10.1 in. (182 x 257 mm)		
ISO B5	6.93 x 9.84 in. (176 x 250 mm)		
A6	4.13 x 5.85 in. (105 x 148.5 mm)		
Oficio	8.50 x 13.50 in. (216 x 343 mm)		
US Folio	8.5 x 13 in. (216 x 330 mm)		

Paper	Dimensions ^a	Weight	Capacity ^b
Envelopes			
No.10	4.12 x 9.5 in. (105 x 241mm)		
DL	4.33 x 8.66 in. (110 x 220 mm)	75 to 90 g/m ² bond (20 to 24 lb) for manual feed mode	1 sheet of paper for manual feed mode
C5	6.38 x 9.01 in. (162 x 229 mm)		
C6	4.5 x 6.4in. (114 x 162 mm)		
Monarch	3.875 x 7.5in. (98.4 x 190.5 mm)		
Labels			
Letter	8.5 x 11 in. (216 x 279 mm)	120 to 150 g/m ² bond	
A4	8.3 x 11.7 in. (210 x 297 mm)		
Transparencies			
Letter	8.5 x 11 in. (216 x 279 mm)	138 to 146 g/m ² bond	
A4	8.3 x 11.7 in. (210 x 297 mm)		
Card Stock			
Post Card	4 x 6 in. (101.6 x 152.4 mm)	90 to 163 g/m ² bond (16 to 43 lb) for manual feed mode	
Minimum Size (custom)	3 x 5 in. (76 x 127 mm)		
Maximum Size (Legal)	8.5 x 14 in. (216 x 356 mm)	60 to 165 g/m ² bond (16 to 43lb) for manual feed mode	

^a The printer supports a wide range of media sizes.

^b Capacity may vary depending on print materials' weight and thickness, and environmental conditions.

Loading Paper in the Paper Tray

Load up to 150 sheets of plain paper in the paper tray.

- 1 Open the paper input tray. Pull on the length and width guides to extend the tray.

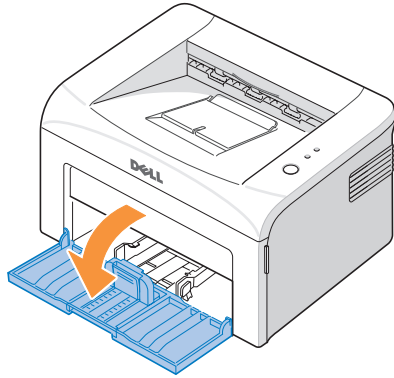

- 2 Flex the sheets back and forth to loosen them, and then fan them out. Do not fold or crease the print media. Align the edges on a level surface.

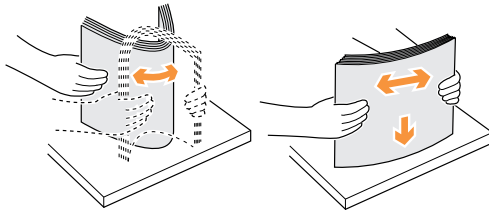

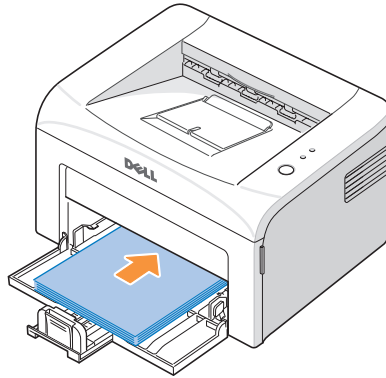

- 3 Load paper in the paper tray with the side to be printed on facing up.

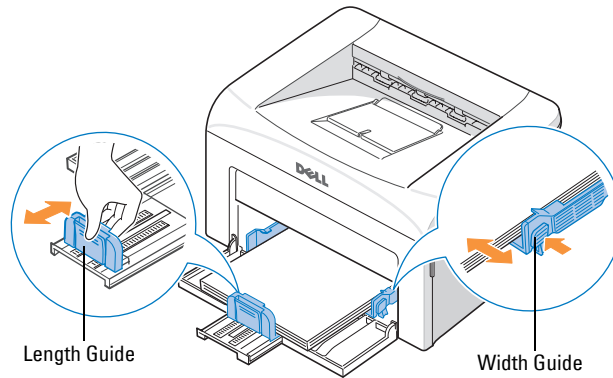

Make sure that all four corners are flat in the tray.

- 4 Be careful not to overload the paper tray. Overloading may cause paper jams.
- 5 Squeeze the length guide and slide it until it lightly touches the end of the paper stack. Squeeze the width guide and move it toward the stack of paper until it lightly touches the side of the stack.



 **NOTE:** Improper adjustment of paper guides can result in paper jams.

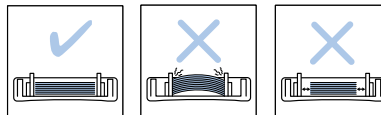

Loading Paper Using Manual Feed Mode

If you select **Manual Feed** in the **Source** option in your software application, you can manually load a sheet of print material in the tray. Manually loading paper can be helpful when you want to check the print quality after each page is printed.

Use the manual feed mode to print transparencies, labels, envelopes, or postcards in addition to paper types or sizes that are not currently loaded in the paper tray.

 **NOTE:** Flatten any curl on postcards, envelopes, and labels before loading them into the paper tray.

- 1 Load a sheet of print material in the paper tray with the side to be printed on facing up.

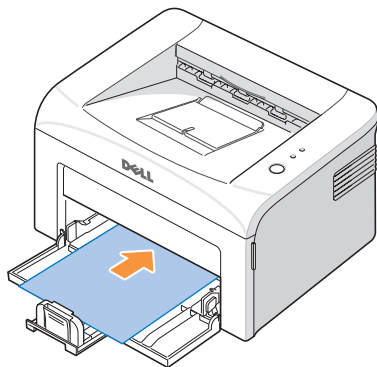

- 2 Adjust the paper length and width guides against the print material without bending the paper.
- 3 To print a document in Manual Feed mode, you must select **Manual Feed** for **Source** from the software application, and then select the appropriate paper size and type. For details, see the *HTML User's Guide*.
- 4 Press  on the printer's operator panel to start feeding.

Printing starts.

 **NOTE:** If you don't press the button after a pause, the paper will be automatically fed into the printer.

- 5 *If you are printing multiple pages*, load the next sheet after the first page prints out, and press .

Repeat this step for every page to be printed.

Loading Special Materials

- 1 Open the paper input tray.
- 2 Load the print material in the paper input tray. Do not mix types.
- 3 Adjust the length and width guides against the print material without bending it.
- 4 To print on special material, you must select **Manual Feed for Source** from the software application, and then select the appropriate paper size and type. For details, see the *HTML User's Guide*.
- 5 Press  to start.

See the following directions to load each type of print material.

- Load an envelope in the tray **with the flap side down** and the stamp area **on the top left side**. The end of the envelope **with the stamp area enters the printer first**, from the center of the tray.

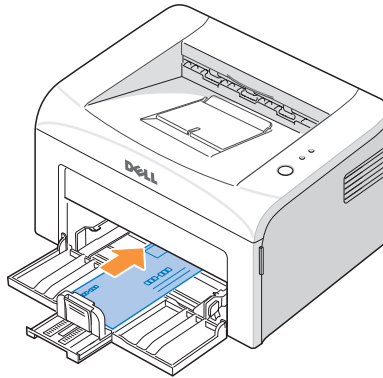

 **NOTICE:** Never load envelopes with stamps, clasps, snaps, windows, coated linings, or self-stick adhesives. These envelopes may severely damage the printer. The stamp is shown in the illustration only for placement.

 **CAUTION:** If you print 20 envelopes in succession, the surface of the top cover may become hot. Please exercise caution.

- Load a sheet of labels in the tray with the side to be printed on facing up.

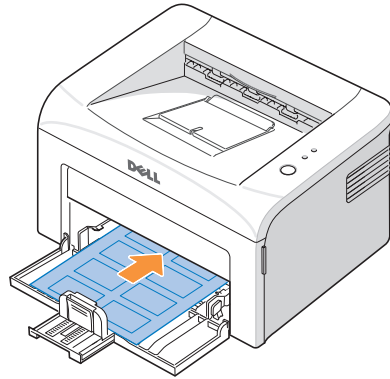

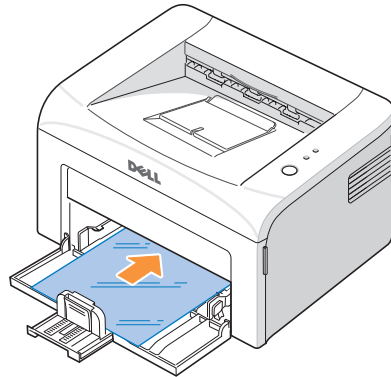

 **NOTE:** To prevent labels from sticking to each other, do not let the printed label sheets stack up as they are printed out.

- Load a transparency in the tray with the side to be printed on facing up, and the top with the adhesive strip inserted first.





 **NOTE:** To prevent transparencies from sticking to each other, do not let the printed sheets stack up as they are printed out.

 **NOTE:** Place transparencies on a flat surface after removing them from the printer.

 **NOTE:** Do not use transparencies that are separating from the backing sheet.

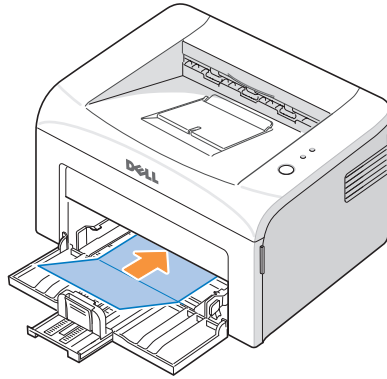
- Load a sheet of card stock with the side to be printed on facing up, short edge first, from the center of the tray.



 **NOTE:** Do not print on media smaller than 3.0 in. (76 mm) wide or 5.0 in. (127 mm) long.

- Load a letterhead in the tray with the design face up, top edge toward the printer.

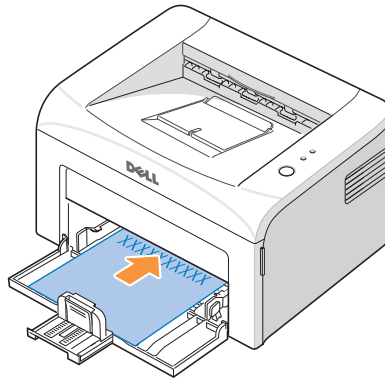



 **NOTE:** Before you load letterhead, verify that the ink on the paper is dry. During the fusing process, wet ink can come off preprinted paper.

Printing

Basic Printing

- 1 Load paper. See page 19.
- 2 With your document open, click **File** → **Print**. Make sure that your printer is selected.
- 3 To change the printer settings, click **Properties**, **Preferences**, **Options**, or **Setup**, depending on the program or operating system.
The printer properties window displays.
- 4 From the five tabs on the top of the printer properties window, confirm the selections.
- 5 Click **OK** until the Print window appears.
- 6 Click **OK** or **Print**, depending on the program or operating system, to start printing.



NOTE: Press  on the operator panel to cancel a print job. In Manual Feed mode, you can't cancel a print job by pressing .

Accessing Printer Properties

Change printer settings in the printer properties tabs. The printer properties window differs, depending on your operating system.

- 1 With your document open, click **File** → **Print**.
The Print window appears.
- 2 In the Print window, click **Properties**, **Preferences**, **Options**, or **Setup**, depending on your program or operating system.
- 3 For details about the printer properties tabs, please refer to the *HTML User's Guide*.

Setting High Altitude Correction

If your printer is going to be used at an altitude above 2,500 m (8,200 ft), you can optimize the print quality for those circumstances using the High Altitude Correction option.

- 1 Click the Windows **Start** menu.
- 2 Click **Settings** and then **Printer**, or **Printers and Faxes**.
- 3 Select the **Dell Laser Printer 1100** icon.
- 4 Right-click on the printer icon and select **Properties**.
- 5 Click the **Printer** tab and select the **High Altitude Correction** checkbox.

Sharing Your Printer Locally

You can connect the printer directly to a selected computer, called the “host computer,” on a network using a USB cable. Your printer can be shared by other users on the network through a Windows 98, Me, 2000, or XP network printer connection. Before you can share your printer, you must first setup a Microsoft Windows network.

In Windows 98/Me

Setting Up the Host Computer

- 1 Start Windows.
- 2 Click the **Start** button, select **Control Panel**, and double-click the **Network** icon.
- 3 Click the **File and Print Sharing** box, check the box next to **I want to be able to allow others to print to my printer**, and click **OK**.
- 4 Click **Start** and select **Printers** from **Settings**. Double-click your printer name.
- 5 Click **Properties** in the Printer menu.
- 6 Click the **Sharing** tab and check the **Shared As** box. Fill in the **Share Name** field and then click **OK**.

Setting Up the Client Computer

- 1 Right-click the **Start** button and select **Explore**.
- 2 Open your network folder in the left column.
- 3 Right-click the shared name and click **Capture Printer Port**.
- 4 Select the port you want, check the **Reconnect at log on** box, and then click **OK**.
- 5 Click the **Start** button and select **Settings** and then **Printers**.
- 6 Double-click your printer icon.
- 7 Click the **Printer** menu and point to **Properties**.
- 8 Click the **Details** tab, select the printer port, and then click **OK**.

In Windows 2000/XP

Setting Up the Host Computer

- 1 Start Windows.
- 2 For Windows 2000, click the **Start** button → **Settings** → **Printers**.
For Windows XP, click the **Start** button and select **Printers and Faxes**.
- 3 Double-click your printer icon.
- 4 Click the **Printer** menu and select **Sharing**.
- 5 For Windows 2000, check the **Shared As** box.
For Windows XP, check the **Share this printer** box.
- 6 Fill in the **Share Name** field and click **OK**.

Setting Up the Client Computer

- 1 Right-click the **Start** button and select **Explore**.
- 2 Open your network folder in the left column.
- 3 Click the shared name. If you can't find the shared name, make sure that the user account for the client computer is registered on the host computer.
- 4 For Windows 2000, from the **Start** button, click **Settings** and select **Printers**.
For Windows XP, from the **Start** button, click and select **Printers and Faxes**.
- 5 Double-click your printer icon.
- 6 Click the **Printer** menu and select **Properties**.
- 7 Click the **Ports** tab and select **Add Port**.
- 8 Click **Local Port** and select **New Port**.
- 9 Fill in the **Enter a port name** field and enter the shared name.
- 10 Click **OK** and select **Close**.
- 11 Click **Apply** and select **OK**.

Maintenance

Ordering Supplies

You can order supplies using the Dell™ Toner Management System or by contacting Dell at www.dell.com/supplies.

In addition to the toner level indicator that is displayed in the Printing Status window each time you send a job to print, the printer's operator panel LED sequences tell you about the status of your supplies. When  lights orange, your toner cartridge is low and you should order a new toner cartridge.

- 1 Double-click the Dell Toner Reorder Program icon on your desktop.

OR

From the **Start** menu, click **Programs** → **Dell Printers** → **Dell Laser Printer 1100** → **Dell Toner Reorder Program**.

OR

In the Printing Status window, click the **Order Supplies** button.

- 2 The Order Toner Cartridges window appears.

Click **Visit Dell's cartridge ordering web site** to order supplies online.

If ordering by phone, call the number that appears under the **By Telephone** heading.

Replacing the Toner Cartridge

⚠ CAUTION: Before performing any of the procedures listed in this section, read and follow the safety information on page 1.

⚠ CAUTION: Do not touch the green underside of the toner cartridge. Use the handle on the cartridge to avoid touching this area.

When the toner cartridge is near the end of its life,  on the operator panel lights orange. Additional pages may be printed, but white streaks or light print will occur. Gently shake the toner cartridge from side-to-side 5 or 6 times to distribute the toner evenly and temporarily improve print quality.

When the toner eventually runs out, only blank pages print. At this stage, the toner cartridge needs to be replaced.

To order more toner, go to www.dell.com/supplies.

⚠ CAUTION: For best results, use Dell toner cartridges. Print quality and printer reliability are not guaranteed if you do not use Dell supplies.

To replace the toner cartridge:

- 1 Open the front cover.

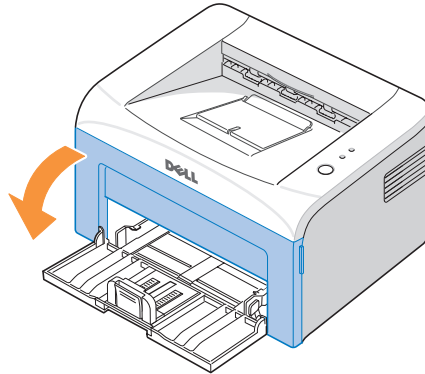

- 2 Pull the used toner cartridge out and lift it up and away from the printer.

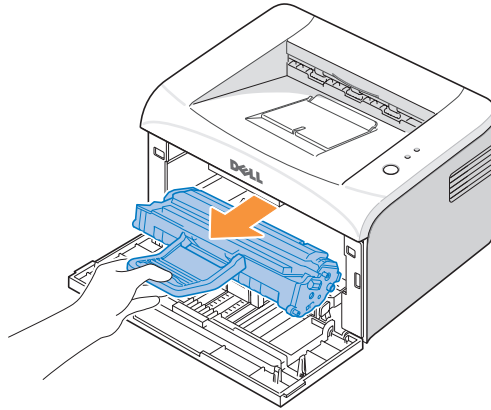

⚠ CAUTION: Avoid reaching too far into the printer. The fusing area may be hot.

- 3 Unpack a new toner cartridge. Hold the cartridge carefully and gently shake it from side-to-side 5 or 6 times to distribute the toner.

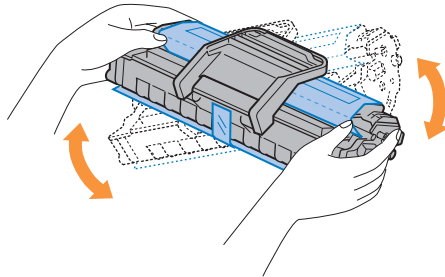

🖨 NOTE: If toner comes into contact with your clothing, wipe the toner off with a dry cloth and wash your clothing in cold water. Hot water sets toner into fabric.

⚠ CAUTION: Do not touch the green underside of the toner cartridge. Use the handle on the cartridge to avoid touching this area.

⚠ CAUTION: To prevent damage to the toner cartridge, do not expose it to light for more than a few minutes.

- 4 Pull the tape to remove the protective paper.

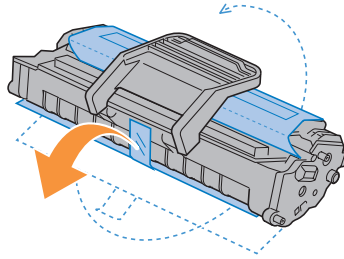

- 5 Locate the cartridge slot inside the printer, one on each side.

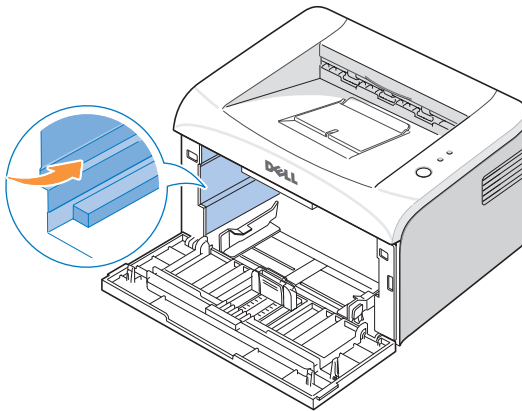

- 6 Unfold the toner cartridge handle and grasp it. Insert the cartridge into the printer until it snaps into place.

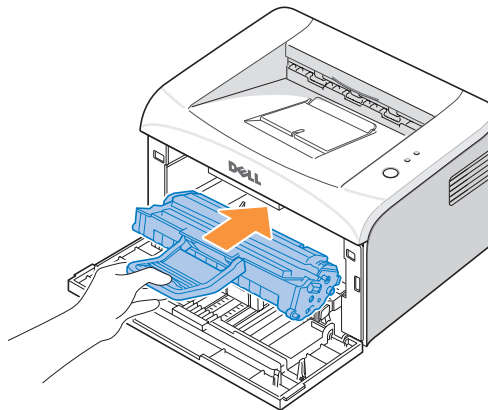

- 7 Close the front cover. Make sure that the cover is securely closed. If it is not firmly closed, printing errors may occur.

Cleaning Your Printer

To maintain print quality, follow the cleaning procedures below, each time the toner cartridge is replaced or *if print quality problems occur*.

 **NOTE:** Do not touch the transfer roller located under the toner cartridge when cleaning inside the printer. Oil from your fingers may cause print quality problems.

 **CAUTION:** Cleaning solvents that contain alcohol or other strong substances may discolor or crack the printer cabinet.

Cleaning the Exterior

Clean the printer cabinet with a soft, damp, and lint-free cloth. Do not let water drip onto the printer or inside the printer.

Cleaning the Interior

Paper, toner, and dust particles can accumulate inside the printer and cause print quality problems, such as smearing or toner specks. Clean inside the printer to prevent these problems.

- 1 Power the printer off and unplug the power cord. Wait approximately 10 minutes for the printer to cool down.
- 2 Open the front cover.

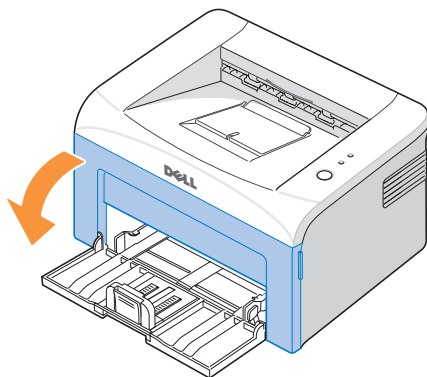

- 3 Gently pull the toner cartridge out, being careful not to scratch against the printer, and lift it up and away from the printer. Set it on a clean flat surface.

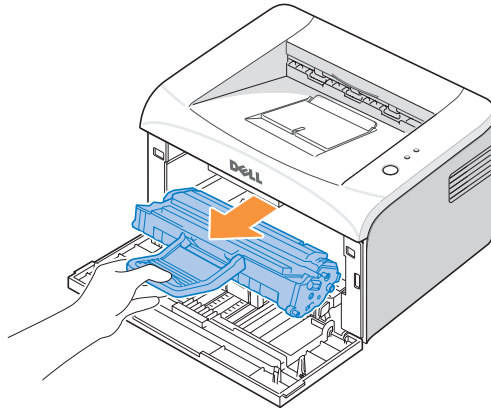

⚠ CAUTION: To prevent damage to the toner cartridge, do not expose the toner cartridge to light for more than a few minutes.

⚠ CAUTION: Do not touch the green underside of the toner cartridge. Use the handle on the cartridge to avoid touching this area.

- 4 With a dry and lint-free cloth, wipe away any dust and spilled toner from the toner cartridge area and the toner cartridge cavity.

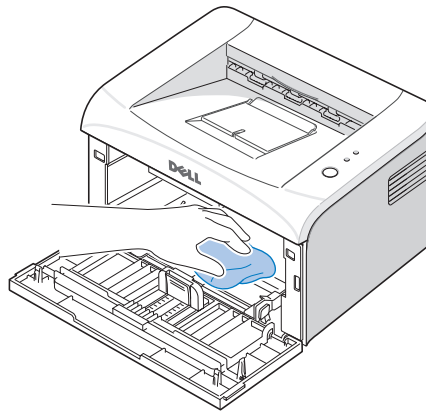

⚠ CAUTION: Do not touch the transfer roller inside the printer. Oil from your fingers may cause print quality problems.

- 5 Reinsert the toner cartridge and close the front cover.
- 6 Plug in the power cord and power the printer on.

Troubleshooting

Clearing Jams in the Paper Tray

If a paper jam occurs,  on the operator panel lights red. Find and remove the jammed paper. If you cannot see it, look inside the printer.

To avoid tearing the paper, pull the jammed paper out gently and slowly. Follow the steps below to clear the jam.

Paper Feed Jam

- 1 Remove any misfed paper by pulling it out by its visible edge. Make sure that all of the paper is properly aligned in the tray.

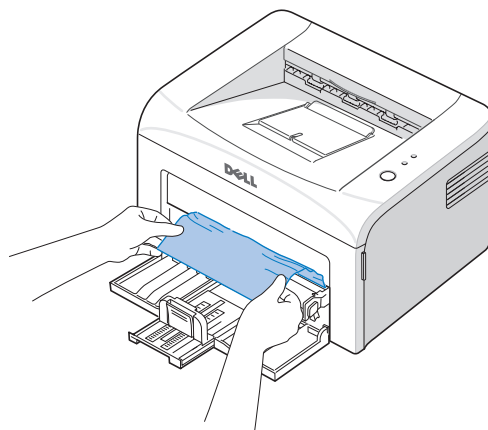



- 2 Open and close the front or top cover to resume printing the document from failed pages.

Paper Exit Jam

 **NOTE:** Paper jams in this area may result in loose toner on the page. If you get any toner on your clothes, wash them in cold water as hot water will set the toner into the fabric.

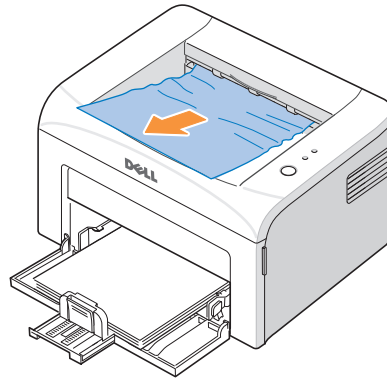
- 1 *If the paper jams as it exits to the output tray and a long portion of the paper is visible, pull the paper straight out. Open and close the front or top cover to resume printing.*



 **NOTE:** Failed pages will not reprint. Reprint the failed pages.

- 2 *If you cannot see the paper in the output tray or the paper does not move when pulled, stop pulling and open the top cover and the inner cover.*

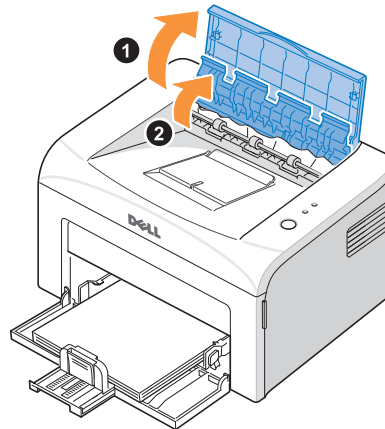

 **CAUTION:** The top and inner cover themselves may also be hot due to the heat roller (located underneath the inner cover). Allow the printer to cool before opening the covers.

- 3 Loosen the paper if it is caught in the heat roller. Then remove the paper by gently pulling it out.

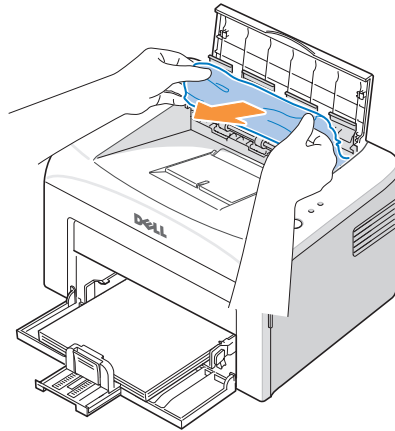

⚠ CAUTION: When removing jammed paper, be careful not to touch the heat roller (located underneath the inner cover). It is hot and could cause burns!

- 4 Close the inner cover and the top cover. Printing resumes automatically.

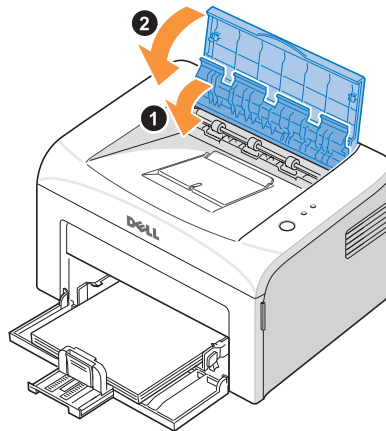

📄 NOTE: Failed pages will not reprint. Reprint the failed pages.

Fuser Area Jam

➔ **NOTICE:** The fuser area is hot. Take care when removing paper from the printer.

- 1 Open the front cover.

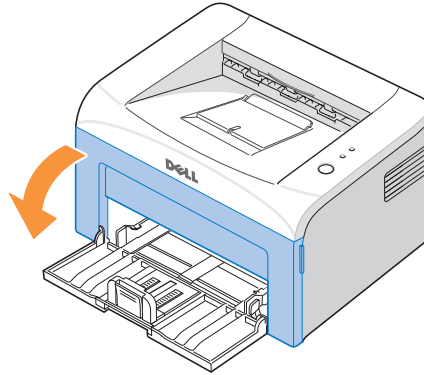

- 2 Gently pull the toner cartridge out, being careful not to scratch against the printer, and lift it up and away from the printer.

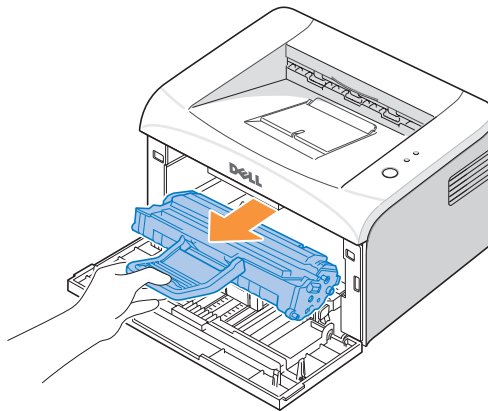

- 3 Remove the paper by gently pulling it toward you.

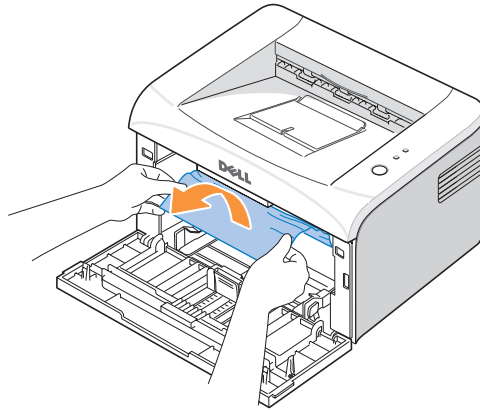

- 4 Check that there is no other paper in the printer.
- 5 Reinstall the toner cartridge and close the front cover. Your printer resumes printing the document from failed pages.

Tips for Avoiding Paper Jams

By selecting the correct paper types, most paper jams can be avoided. When a paper jam occurs, follow the steps outlined in "Clearing Jams in the Paper Tray" on page 35.



- Follow the procedures in "Loading Paper in the Paper Tray" on page 19. Ensure that the adjustable guides are correctly positioned.
- Do not overload the paper tray.
- Do not remove the paper from the tray while your printer is printing.
- Do not add paper to the tray while your printer is printing.
- Flex, fan, and straighten the paper before loading.
- Do not use creased, damp, or curled paper.
- Do not mix paper types in the paper tray.
- Use only recommended print materials. See page 17.
- Ensure that the recommended print side of print materials is facing up in the paper tray.

Understanding the Operator Panel LEDs







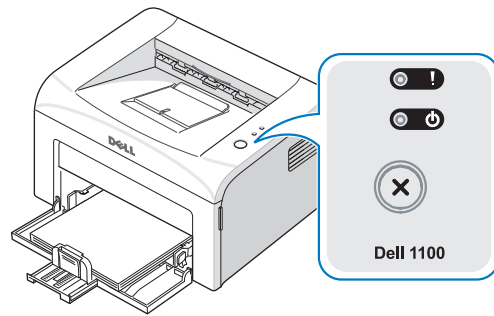

The operator panel LEDs signify different things, depending on their sequences. LEDs that are off, on, and/or blinking indicate printer conditions such as printer status, intervention (for example, out of paper and jammed paper), or service.







The following table shows the most common LED sequences. Find the LED pattern below that matches the printer LED pattern and check the meaning and solution.

LED Status Legend

-  symbol for “light off”
-  symbol for “light on”
-  symbol for “light blinking”



LED Pattern	Meaning and Suggested Solution
 (Red)	Your printer has some problems. <i>If this problem occurs</i> , contact your service representative.
 (Green)	
 (Red) 	<ul style="list-style-type: none"> • A paper jam has occurred. To solve the problem, see “Clearing Jams in the Paper Tray” on page 35. • The front cover is open. Close the front cover. • The top cover is open. Close the top cover. • A toner cartridge is not installed. Install a toner cartridge. See “Replacing the Toner Cartridge” on page 30.
 (Green) 	<ul style="list-style-type: none"> • If the printer is receiving data,  blinks green slowly. • If the printer is printing received data,  blinks green quickly.

LED Pattern	Meaning and Suggested Solution
 (Red)	<ul style="list-style-type: none"> You pressed  while the printer was receiving data. In Manual Duplex mode, the first side of your job has printed. Load the paper back into the tray with the already-printed side down and the top of the page toward the front of the tray. Then press  to start printing. For details, see the HTML User's Guide. You print in 600 dpi resolution and your printer does not have enough memory to print the current job. When the Printing Status window appears, select one of the following options: <ul style="list-style-type: none"> Click Cancel. An Internal error sheet prints and the current job automatically clears. Try simplifying the page layout and removing unnecessary graphics from your document. Click Print. Your printer prints the current job in 300 dpi resolution. If a memory shortage occurs again, the Printing Status window will appear again and an Internal error sheet will print. The current job automatically clears. Try simplifying the page layout and removing unnecessary graphics from your document.
 (Orange)	<p>In Manual Feed mode, there is no paper in the paper tray. Load paper into the tray and press  to start printing.</p>
 (Orange)	<p>The toner cartridge is nearly empty. Redistribute the toner to temporarily extend the life of the toner cartridge. <i>If this does not improve print quality</i>, install a new toner cartridge. See page 30.</p>

More Troubleshooting

For more information about printing problems, see your *HTML User's Guide*.

Contacting Dell

Technical Assistance

If you need help with a technical problem, Dell is ready to assist you.

- 1 Call technical support from a telephone near or at the printer so that technical support can assist you with any necessary procedures. When calling Dell, use your Express Service Code to help expedite the routing of your call to the proper support personnel.

If you open the front cover, the Express Service Code is located on the front left side of the printer, as shown below.

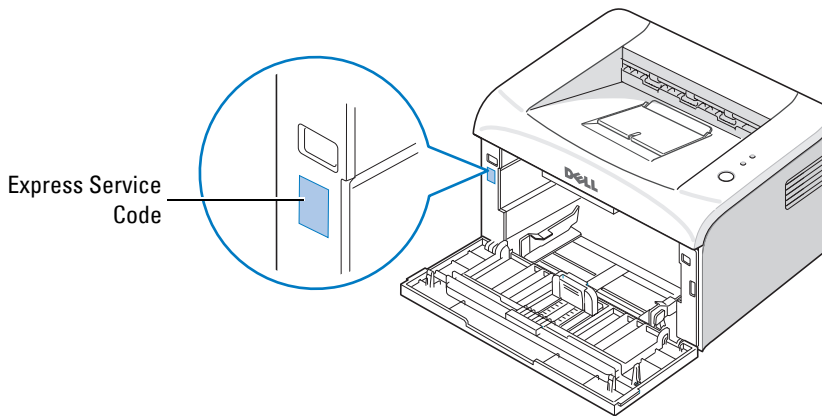

NOTE: Dell's Express Service Code system may not be available in all countries.

- 2 In the U.S., Business customers should call 1-877-459-7298, and Consumer (Home and Home Office) customers should call 1-800-624-9896.

If you are calling from a different country or are in a different Service area, see "Contacting Dell" on page 44 for your local telephone number.

- 3 Follow the menu prompts in the automated telephone system to speak with a technical support representative.

Automated Order-Status Service

To check on the status of any Dell™ products that you have ordered, you can go to support.dell.com, or you can call the automated order-status service. A recording prompts you for the information needed to locate and report on your order. See "Contacting Dell" for the telephone number to call for your region.

Contacting Dell

To contact Dell electronically, you can access the following websites:

- www.dell.com
- support.dell.com (technical support)
- premiersupport.dell.com (technical support for educational, government, healthcare, and medium/large business customers, including Premier, Platinum, and Gold customers)

For specific web addresses for your country, find the appropriate country section in the table below.

 **NOTE:** Toll-free numbers are for use within the country for which they are listed.

When you need to contact Dell, use the electronic addresses, telephone numbers, and codes provided in the following table. If you need assistance in determining which codes to use, contact a local or an international operator.

Country (City) International Access Code Country Code City Code	Department Name or Service Area, Website and E-Mail Address	Area Codes, Local Numbers, and Toll-Free Numbers
U.S.A. (Austin, Texas)	Automated Order-Status Service	toll-free: 1-800-433-9014
International Access Code: 011 Country Code: 1	AutoTech (portable and desktop computers)	toll-free: 1-800-247-9362
	Consumer (Home and Home Office)	
	Technical Support	toll-free: 1-800-624-9896
	Customer Service	toll-free: 1-800-624-9897
	DellNet™ Service and Support	toll-free: 1-877-Dellnet (1-877-335-5638)
	Employee Purchase Program (EPP) Customers	toll-free: 1-800-695-8133
	Financial Services website: www.dellfinancialservices.com	
	Financial Services (lease/loans)	toll-free: 1-877-577-3355
	Financial Services (Dell Preferred Accounts [DPA])	toll-free: 1-800-283-2210
	Business	
	Customer Service and Technical Support	toll-free: 1-877-459-7298
	Employee Purchase Program (EPP) Customers	toll-free: 1-800-695-8133
	Printers and Projectors Technical Support	toll-free: 1-877-459-7298
	Public (government, education, and healthcare)	
	Customer Service and Technical Support	toll-free: 1-800-456-3355
	Employee Purchase Program (EPP) Customers	toll-free: 1-800-234-1490
	Dell Sales	toll-free: 1-800-289-3355 or toll-free: 1-800-879-3355
	Dell Outlet Store (Dell refurbished computers)	toll-free: 1-888-798-7561
	Software and Peripherals Sales	toll-free: 1-800-671-3355
	Spare Parts Sales	toll-free: 1-800-357-3355
	Extended Service and Warranty Sales	toll-free: 1-800-247-4618
	Fax	toll-free: 1-800-727-8320
	Dell Services for the Deaf, Hard-of-Hearing, or Speech-Impaired	toll-free: 1-877-DELLTTY (1-877-335-5889)
Anguilla	General Support	toll-free: 800-335-0031
Antigua and Barbuda	General Support	

Country (City) International Access Code Country Code City Code	Department Name or Service Area, Website and E-Mail Address	Area Codes, Local Numbers, and Toll-Free Numbers
Argentina (Buenos Aires)	Website: www.dell.com.ar	
International Access Code: 00	E-mail: us_latin_services@dell.com	
Country Code: 54	E-mail for desktop and portable computers: la-techsupport@dell.com	
City Code: 11	E-mail for servers and EMC: la_enterprise@dell.com	
	Customer Care	toll-free: 0-800-444-0730
	Tech Support	toll-free: 0-800-444-0733
	Tech Support Services	toll-free: 0-800-444-0724
	Sales	0-810-444-3355
Aruba	General Support	toll-free: 800-1578
Australia (Sydney)	E-mail (Australia): au_tech_support@dell.com	
International Access Code: 0011	E-mail (New Zealand): nz_tech_support@dell.com	
Country Code: 61	Home and Small Business	1-300-65-55-33
City Code: 2	Government and Business	toll-free: 1-800-633-559
	Preferred Accounts Division (PAD)	toll-free: 1-800-060-889
	Customer Care	toll-free: 1-800-819-339
	Corporate Sales	toll-free: 1-800-808-385
	Transaction Sales	toll-free: 1-800-808-312
	Fax	toll-free: 1-800-818-341
Austria (Vienna)	Website: support.euro.dell.com	
International Access Code: 900	E-mail: tech_support_central_europe@dell.com	
Country Code: 43	Home/Small Business Sales	0820 240 530 00
City Code: 1	Home/Small Business Fax	0820 240 530 49
	Home/Small Business Customer Care	0820 240 530 14
	Preferred Accounts/Corporate Customer Care	0820 240 530 16
	Home/Small Business Technical Support	0820 240 530 14
	Preferred Accounts/Corporate Technical Support	0660 8779
	Switchboard	0820 240 530 00
Bahamas	General Support	toll-free: 1-866-278-6818
Barbados	General Support	1-800-534-3066

Country (City) International Access Code Country Code City Code	Department Name or Service Area, Website and E-Mail Address	Area Codes, Local Numbers, and Toll-Free Numbers
Belgium (Brussels) International Access Code: 00 Country Code: 32 City Code: 2	Website: support.euro.dell.com E-mail: tech_be@dell.com E-mail for French Speaking Customers: support.euro.dell.com/be/fr/emaildell/ Technical Support Customer Care Corporate Sales Fax Switchboard	02 481 92 88 02 481 91 19 02 481 91 00 02 481 92 99 02 481 91 00
Bermuda	General Support	1-800-342-0671
Bolivia	General Support	toll-free: 800-10-0238
Brazil International Access Code: 00 Country Code: 55 City Code: 51	Website: www.dell.com/br Customer Support, Technical Support Tech Support Fax Customer Care Fax Sales	0800 90 3355 51 481 5470 51 481 5480 0800 90 3390
British Virgin Islands	General Support	toll-free: 1-866-278-6820
Brunei Country Code: 673	Customer Technical Support (Penang, Malaysia) Customer Service (Penang, Malaysia) Transaction Sales (Penang, Malaysia)	604 633 4966 604 633 4949 604 633 4955
Canada (North York, Ontario) International Access Code: 011	Online Order Status: www.dell.ca/ostatus AutoTech (automated technical support) TechFax Customer Care (Home Sales/Small Business) Customer Care (med./large business, government) Technical Support (Home Sales/Small Business) Technical Support (med./large bus., government) Sales (Home Sales/Small Business) Sales (med./large bus., government) Spare Parts Sales & Extended Service Sales	toll-free: 1-800-247-9362 toll-free: 1-800-950-1329 toll-free: 1-800-847-4096 toll-free: 1-800-326-9463 toll-free: 1-800-847-4096 toll-free: 1-800-387-5757 toll-free: 1-800-387-5752 toll-free: 1-800-387-5755 1 866 440 3355
Cayman Islands	General Support	1-800-805-7541

Country (City) International Access Code Country Code City Code	Department Name or Service Area, Website and E-Mail Address	Area Codes, Local Numbers, and Toll-Free Numbers
Chile (Santiago) Country Code: 56 City Code: 2	Sales, Customer Support, and Technical Support	toll-free: 1230-020-4823
China (Xiamen) Country Code: 86 City Code: 592	Tech Support website: support.dell.com.cn Tech Support E-mail: cn_support@dell.com Customer Care E-mail: customer_cn@dell.com Technical Support Fax Technical Support (Dell™ Dimension™ and Inspiron™) Technical Support (OptiPlex™, Latitude™, and Dell Precision™) Technical Support (servers and storage) Technical Support (projectors, PDAs, switches, printers, routers, and so on) Technical Support (printers) Customer Care Customer Care Fax Home and Small Business Preferred Accounts Division Large Corporate Accounts GCP Large Corporate Accounts Key Accounts Large Corporate Accounts North Large Corporate Accounts North Government and Education Large Corporate Accounts East Large Corporate Accounts East Government and Education Large Corporate Accounts Queue Team Large Corporate Accounts South Large Corporate Accounts West Large Corporate Accounts Spare Parts	592 818 1350 toll-free: 800 858 2969 toll-free: 800 858 0950 toll-free: 800 858 0960 toll-free: 800 858 2920 86 592 818 3144 or toll-free: 800 858 2311 toll-free: 800 858 2060 592 818 1308 toll-free: 800 858 2222 toll-free: 800 858 2557 toll-free: 800 858 2055 toll-free: 800 858 2628 toll-free: 800 858 2999 toll-free: 800 858 2955 toll-free: 800 858 2020 toll-free: 800 858 2669 toll-free: 800 858 2527 toll-free: 800 858 2355 toll-free: 800 858 2811 toll-free: 800 858 2621

Country (City) International Access Code Country Code City Code	Department Name or Service Area, Website and E-Mail Address	Area Codes, Local Numbers, and Toll-Free Numbers
Colombia	General Support	980-9-15-3978
Costa Rica	General Support	0800-012-0435
Czech Republic (Prague)	Website: support.euro.dell.com	
International Access Code: 00	E-mail: czech_dell@dell.com	
Country Code: 420	Technical Support	02 2186 27 27
City Code: 2	Customer Care	02 2186 27 11
	Fax	02 2186 27 14
	TechFax	02 2186 27 28
	Switchboard	02 2186 27 11
Denmark (Copenhagen)	Website: support.euro.dell.com	
International Access Code: 00	E-mail: support.euro.dell.com/dk/da/emaildell/	
Country Code: 45	Technical Support	7023 0182
	Customer Care (Relational)	7023 0184
	Home/Small Business Customer Care	3287 5505
	Switchboard (Relational)	3287 1200
	Switchboard Fax (Relational)	3287 1201
	Switchboard (Home/Small Business)	3287 5000
	Switchboard Fax (Home/Small Business)	3287 5001
Dominica	General Support	toll-free: 1-866-278-6821
Dominican Republic	General Support	1-800-148-0530
Ecuador	General Support	toll-free: 999-119
El Salvador	General Support	01-899-753-0777
Finland (Helsinki)	Website: support.euro.dell.com	
International Access Code: 990	E-mail: support.euro.dell.com/fi/fi/emaildell/	
Country Code: 358	Technical Support	09 253 313 60
City Code: 9	Customer Care	09 253 313 38
	Fax	09 253 313 99
	Switchboard	09 253 313 00

Country (City) International Access Code Country Code City Code	Department Name or Service Area, Website and E-Mail Address	Area Codes, Local Numbers, and Toll-Free Numbers
France (Paris) (Montpellier)	Website: support.euro.dell.com	
International Access Code: 00	E-mail: support.euro.dell.com/ft/fr/emaildell/	
Country Code: 33	Home and Small Business	
City Codes: (1) (4)	Technical Support	0825 387 270
	Customer Care	0825 823 833
	Switchboard	0825 004 700
	Switchboard (calls from outside of France)	04 99 75 40 00
	Sales	0825 004 700
	Fax	0825 004 701
	Fax (calls from outside of France)	04 99 75 40 01
	Corporate	
	Technical Support	0825 004 719
	Customer Care	0825 338 339
	Switchboard	01 55 94 71 00
	Sales	01 55 94 71 00
	Fax	01 55 94 71 01
Germany (Langen)	Website: support.euro.dell.com	
International Access Code: 00	E-mail: tech_support_central_europe@dell.com	
Country Code: 49	Technical Support	06103 766-7200
City Code: 6103	Home/Small Business Customer Care	0180-5-224400
	Global Segment Customer Care	06103 766-9570
	Preferred Accounts Customer Care	06103 766-9420
	Large Accounts Customer Care	06103 766-9560
	Public Accounts Customer Care	06103 766-9555
	Switchboard	06103 766-7000

Country (City) International Access Code Country Code City Code	Department Name or Service Area, Website and E-Mail Address	Area Codes, Local Numbers, and Toll-Free Numbers
Greece	Website: support.euro.dell.com	
International Access Code: 00	E-mail: support.euro.dell.com/gr/en/emaildell/	
Country Code: 30	Technical Support	080044149518
	Gold Technical Support	08844140083
	Switchboard	2108129800
	Sales	2108129800
	Fax	2108129812
Grenada	General Support	toll-free: 1-866-540-3355
Guatemala	General Support	1-800-999-0136
Guyana	General Support	toll-free: 1-877-270-4609
Hong Kong	Website: support.ap.dell.com	
International Access Code: 001	Technical Support E-mail: apsupport@dell.com	
Country Code: 852	Technical Support (Dimension and Inspiron)	2969 3188
	Technical Support (OptiPlex, Latitude, and Dell Precision)	2969 3191
	Technical Support (PowerApp™, PowerEdge™, PowerConnect™, and PowerVault™)	2969 3196
	Customer Care	3416 0910
	Large Corporate Accounts	3416 0907
	Global Customer Programs	3416 0908
	Medium Business Division	3416 0912
	Home and Small Business Division	2969 3105
India	Technical Support	1600 33 8045
	Sales (Large Corporate Accounts)	1600 33 8044
	Sales (Home and Small Business)	1600 33 8046

Country (City) International Access Code Country Code City Code	Department Name or Service Area, Website and E-Mail Address	Area Codes, Local Numbers, and Toll-Free Numbers
Ireland (Cherrywood)	Website: support.euro.dell.com	
International Access Code: 16	E-mail: dell_direct_support@dell.com	
Country Code: 353	Technical Support	1850 543 543
City Code: 1	U.K. Technical Support (dial within U.K. only)	0870 908 0800
	Home User Customer Care	01 204 4014
	Small Business Customer Care	01 204 4014
	U.K. Customer Care (dial within U.K. only)	0870 906 0010
	Corporate Customer Care	1850 200 982
	Corporate Customer Care (dial within U.K. only)	0870 907 4499
	Ireland Sales	01 204 4444
	U.K. Sales (dial within U.K. only)	0870 907 4000
	Fax/SalesFax	01 204 0103
	Switchboard	01 204 4444
Italy (Milan)	Website: support.euro.dell.com	
International Access Code: 00	E-mail: support.euro.dell.com/it/it/emaildell/	
Country Code: 39	Home and Small Business	
City Code: 02	Technical Support	02 577 826 90
	Customer Care	02 696 821 14
	Fax	02 696 821 13
	Switchboard	02 696 821 12
	Corporate	
	Technical Support	02 577 826 90
	Customer Care	02 577 825 55
	Fax	02 575 035 30
	Switchboard	02 577 821
Jamaica	General Support (dial from within Jamaica only)	1-800-682-3639

Country (City) International Access Code Country Code City Code	Department Name or Service Area, Website and E-Mail Address	Area Codes, Local Numbers, and Toll-Free Numbers
Japan (Kawasaki)	Website: support.jp.dell.com	
International Access Code: 001	Technical Support (servers)	toll-free: 0120-198-498
Country Code: 81	Technical Support outside of Japan (servers)	81-44-556-4162
City Code: 44	Technical Support (Dimension and Inspiron)	toll-free: 0120-198-226
	Technical Support outside of Japan (Dimension and Inspiron)	81-44-520-1435
	Technical Support (Dell Precision, OptiPlex, and Latitude)	toll-free: 0120-198-433
	Technical Support outside of Japan (Dell Precision, OptiPlex, and Latitude)	81-44-556-3894
	Technical Support (PDAs, projectors, printers, routers)	toll-free: 0120-981-690
	Technical Support outside of Japan (PDAs, projectors, printers, routers)	81-44-556-3468
	Faxbox Service	044-556-3490
	24-Hour Automated Order Service	044-556-3801
	Customer Care	044-556-4240
	Business Sales Division (up to 400 employees)	044-556-1465
	Preferred Accounts Division Sales (over 400 employees)	044-556-3433
	Large Corporate Accounts Sales (over 3500 employees)	044-556-3430
	Public Sales (government agencies, educational institutions, and medical institutions)	044-556-1469
	Global Segment Japan	044-556-3469
	Individual User	044-556-1760
	Switchboard	044-556-4300
Korea (Seoul)	Technical Support	toll-free: 080-200-3800
International Access Code: 001	Sales	toll-free: 080-200-3600
Country Code: 82	Customer Service (Seoul, Korea)	toll-free: 080-200-3800
City Code: 2	Customer Service (Penang, Malaysia)	604 633 4949
	Fax	2194-6202
	Switchboard	2194-6000

Country (City) International Access Code Country Code City Code	Department Name or Service Area, Website and E-Mail Address	Area Codes, Local Numbers, and Toll-Free Numbers
Latin America	Customer Technical Support (Austin, Texas, U.S.A.)	512 728-4093
	Customer Service (Austin, Texas, U.S.A.)	512 728-3619
	Fax (Technical Support and Customer Service) (Austin, Texas, U.S.A.)	512 728-3883
	Sales (Austin, Texas, U.S.A.)	512 728-4397
	SalesFax (Austin, Texas, U.S.A.)	512 728-4600 or 512 728-3772
Luxembourg	Website: support.euro.dell.com	
International Access Code: 00	E-mail: tech_be@dell.com	
Country Code: 352	Technical Support (Brussels, Belgium)	3420808075
	Home/Small Business Sales (Brussels, Belgium)	toll-free: 080016884
	Corporate Sales (Brussels, Belgium)	02 481 91 00
	Customer Care (Brussels, Belgium)	02 481 91 19
	Fax (Brussels, Belgium)	02 481 92 99
	Switchboard (Brussels, Belgium)	02 481 91 00
Macao	Technical Support	toll-free: 0800 105
Country Code: 853	Customer Service (Xiamen, China)	34 160 910
	Transaction Sales (Xiamen, China)	29 693 115
Malaysia (Penang)	Website: support.ap.dell.com	
International Access Code: 00	Technical Support (Dell Precision, OptiPlex, and Latitude)	toll-free: 1 800 88 0193
Country Code: 60	Technical Support (Dimension, Inspiron, and Electronics and Accessories)	toll-free: 1 800 88 1306
City Code: 4	Technical Support (PowerApp, PowerEdge, PowerConnect, and PowerVault)	toll-free: 1800 88 1386
	Customer Service (Penang, Malaysia)	04 633 4949
	Sales	toll-free: 1 800 88 0553

Country (City) International Access Code Country Code City Code	Department Name or Service Area, Website and E-Mail Address	Area Codes, Local Numbers, and Toll-Free Numbers
Mexico	Customer Technical Support	001-877-384-8979
International Access Code: 00		or 001-877-269-3383
Country Code: 52	Sales	50-81-8800
		or 01-800-888-3355
	Customer Service	001-877-384-8979
		or 001-877-269-3383
	Main	50-81-8800
		or 01-800-888-3355
Montserrat	General Support	toll-free: 1-866-278-6822
Netherlands Antilles	General Support	001-800-882-1519
Netherlands (Amsterdam)	Website: support.euro.dell.com	
International Access Code: 00	Technical Support	020 674 45 00
Country Code: 31	Technical Support Fax	020 674 47 66
City Code: 20	Home/Small Business Customer Care	020 674 42 00
	Relational Customer Care	020 674 43 25
	Home/Small Business Sales	020 674 55 00
	Relational Sales	020 674 50 00
	Home/Small Business Sales Fax	020 674 47 75
	Relational Sales Fax	020 674 47 50
	Switchboard	020 674 50 00
	Switchboard Fax	020 674 47 50
New Zealand	E-mail (New Zealand): nz_tech_support@dell.com	
International Access Code: 00	E-mail (Australia): au_tech_support@dell.com	
Country Code: 64	Technical Support (for desktop and portable computers)	toll-free: 0800 446 255
	Technical Support (for servers and workstations)	toll-free: 0800 443 563
	Home and Small Business	0800 446 255
	Government and Business	0800 444 617
	Sales	0800 441 567
	Fax	0800 441 566
Nicaragua	General Support	001-800-220-1006

Country (City) International Access Code Country Code City Code	Department Name or Service Area, Website and E-Mail Address	Area Codes, Local Numbers, and Toll-Free Numbers
Norway (Lysaker)	Website: support.euro.dell.com	
International Access Code: 00	E-mail: support.euro.dell.com/no/no/emailldell/	
Country Code: 47	Technical Support	671 16882
	Relational Customer Care	671 17575
	Home/Small Business Customer Care	231 62298
	Switchboard	671 16800
	Fax Switchboard	671 16865
Panama	General Support	001-800-507-0962
Peru	General Support	0800-50-669
Poland (Warsaw)	Website: support.euro.dell.com	
International Access Code: 011	E-mail: pl_support_tech@dell.com	
Country Code: 48	Customer Service Phone	57 95 700
City Code: 22	Customer Care	57 95 999
	Sales	57 95 999
	Customer Service Fax	57 95 806
	Reception Desk Fax	57 95 998
	Switchboard	57 95 999
Portugal	Website: support.euro.dell.com	
International Access Code: 00	E-mail: support.euro.dell.com/pt/en/emailldell/	
Country Code: 351	Technical Support	707200149
	Customer Care	800 300 413
	Sales	800 300 410 or 800 300 411 or 800 300 412 or 21 422 07 10
	Fax	21 424 01 12
Puerto Rico	General Support	1-800-805-7545
St. Kitts and Nevis	General Support	toll-free: 1-877-441-4731
St. Lucia	General Support	1-800-882-1521
St. Vincent and the Grenadines	General Support	toll-free: 1-877-270-4609

Country (City) International Access Code Country Code City Code	Department Name or Service Area, Website and E-Mail Address	Area Codes, Local Numbers, and Toll-Free Numbers
Singapore (Singapore)	Website: support.ap.dell.com	
International Access Code: 005 Country Code: 65	Technical Support (Dimension, Inspiron, and Electronics and Accessories)	toll-free: 1800 394 7430
	Technical Support (OptiPlex, Latitude, and Dell Precision)	toll-free: 1800 394 7488
	Technical Support (PowerApp, PowerEdge, PowerConnect, and PowerVault)	toll-free: 1800 394 7478
	Customer Service (Penang, Malaysia)	604 633 4949
	Sales	toll-free: 1 800 394 7425
Slovakia (Prague)	Website: support.euro.dell.com	
International Access Code: 00 Country Code: 421	E-mail: czech_dell@dell.com	
	Technical Support	02 5441 5727
	Customer Care	420 22537 2707
	Fax	02 5441 8328
	Tech Fax	02 5441 8328
	Switchboard (Sales)	02 5441 7585
South Africa (Johannesburg)	Website: support.euro.dell.com	
International Access Code: 09/091 Country Code: 27 City Code: 11	E-mail: dell_za_support@dell.com	
	Technical Support	011 709 7710
	Customer Care	011 709 7707
	Sales	011 709 7700
	Fax	011 706 0495
	Switchboard	011 709 7700
Southeast Asian and Pacific Countries	Customer Technical Support, Customer Service, and Sales (Penang, Malaysia)	604 633 4810

Country (City) International Access Code Country Code City Code	Department Name or Service Area, Website and E-Mail Address	Area Codes, Local Numbers, and Toll-Free Numbers
Spain (Madrid) International Access Code: 00 Country Code: 34 City Code: 91	Website: support.euro.dell.com	
	E-mail: support.euro.dell.com/es/es/emaildell/	
	Home and Small Business	
	Technical Support	902 100 130
	Customer Care	902 118 540
	Sales	902 118 541
	Switchboard	902 118 541
	Fax	902 118 539
	Corporate	
	Technical Support	902 100 130
	Customer Care	902 118 546
	Switchboard	91 722 92 00
	Fax	91 722 95 83
	Sweden (Upplands Vasby) International Access Code: 00 Country Code: 46 City Code: 8	Website: support.euro.dell.com
E-mail: support.euro.dell.com/se/sv/emaildell/		
Technical Support		08 590 05 199
Relational Customer Care		08 590 05 642
Home/Small Business Customer Care		08 587 70 527
Employee Purchase Program (EPP) Support		20 140 14 44
Technical Support Fax		08 590 05 594
Sales		08 590 05 185
Switzerland (Geneva) International Access Code: 00 Country Code: 41 City Code: 22	Website: support.euro.dell.com	
	E-mail: swisstech@dell.com	
	E-mail for French-speaking HSB and Corporate Customers: support.euro.dell.com/ch/fr/emaildell/	
	Technical Support (Home and Small Business)	0844 811 411
	Technical Support (Corporate)	0844 822 844
	Customer Care (Home and Small Business)	0848 802 202
	Customer Care (Corporate)	0848 821 721
	Fax	022 799 01 90
	Switchboard	022 799 01 01

Country (City) International Access Code Country Code City Code	Department Name or Service Area, Website and E-Mail Address	Area Codes, Local Numbers, and Toll-Free Numbers
Taiwan	Website: support.ap.dell.com	
International Access Code: 002	E-mail: ap_support@dell.com	
Country Code: 886	Technical Support (OptiPlex, Latitude, Inspiron, Dimension, and Electronics and Accessories)	toll-free: 00801 86 1011
	Technical Support (PowerApp, PowerEdge, PowerConnect, and PowerVault)	toll-free: 00801 60 1256
	Transaction Sales	toll-free: 00801 65 1228
	Corporate Sales	toll-free: 00801 65 1227
Thailand	Website: support.ap.dell.com	
International Access Code: 001	Technical Support (OptiPlex, Latitude, and Dell Precision)	toll-free: 1800 0060 07
Country Code: 66	Technical Support (PowerApp, PowerEdge, PowerConnect, and PowerVault)	toll-free: 1800 0600 09
	Customer Service (Penang, Malaysia)	604 633 4949
	Corporate Sales	toll-free: 1800 006 009
	Transaction Sales	toll-free: 1800 006 006
Trinidad/Tobago	General Support	1-800-805-8035
Turks and Caicos Islands	General Support	toll-free: 1-866-540-3355

Country (City) International Access Code Country Code City Code	Department Name or Service Area, Website and E-Mail Address	Area Codes, Local Numbers, and Toll-Free Numbers
U.K. (Bracknell)	Website: support.euro.dell.com	
International Access Code: 00	Customer Care website: support.euro.dell.com/uk/en/ECare/Form/Home.asp	
Country Code: 44		
City Code: 1344	E-mail: dell_direct_support@dell.com	
	Technical Support (Corporate/Preferred Accounts/PAD [1000+ employees])	0870 908 0500
	Technical Support (direct/PAD and general)	0870 908 0800
	Global Accounts Customer Care	01344 373 186
	Home and Small Business Customer Care	0870 906 0010
	Corporate Customer Care	01344 373 185
	Preferred Accounts (500–5000 employees) Customer Care	0870 906 0010
	Central Government Customer Care	01344 373 193
	Local Government & Education Customer Care	01344 373 199
	Health Customer Care	01344 373 194
	Home and Small Business Sales	0870 907 4000
	Corporate/Public Sector Sales	01344 860 456
	Home and Small Business Fax	0870 907 4006
Uruguay	General Support	toll-free: 000-413-598-2521
Venezuela	General Support	8001-3605

Appendix

U.S Terms and Conditions of Sales

These terms and conditions ("Agreement") apply to your purchase of computer systems and/or related products and/or services and support sold in the United States ("Product") by the Dell entity named on the invoice or acknowledgement ("Dell") provided to you. By accepting delivery of the Product, you accept and are bound to the terms and conditions of this Agreement. If you do not wish to be bound by this Agreement, you must notify Dell immediately and return your purchase pursuant to Dell's Total Satisfaction Return Policy.

(See: <http://support.dell.com/ContactUs/ByPhone.aspx?c=us&l=en&s=gen> for our contact information.) If returned, Product(s) must remain in the boxes in which they were shipped. THIS AGREEMENT SHALL APPLY UNLESS (I) YOU HAVE A SEPARATE PURCHASE AGREEMENT WITH DELL, IN WHICH CASE THE SEPARATE AGREEMENT SHALL GOVERN; OR (II) OTHER DELL TERMS AND CONDITIONS APPLY TO THE TRANSACTION.

1 Other Documents.

This Agreement may NOT be altered, supplemented, or amended by the use of any other document(s) unless otherwise agreed to in a written agreement signed by both you and Dell. If you do not receive an invoice or acknowledgement in the mail, via e-mail, or with your Product, information about your purchase may be obtained at <http://support.dell.com/dellcare/Invoice.aspx> or by contacting your sales representative.

2 Payment Terms; Orders; Quotes; Interest.

Payment terms are within Dell's sole discretion, and, unless otherwise agreed to by Dell, payment must be made at the time of purchase. Payment for Product may be made by credit card, wire transfer, or some other prearranged payment method. Dell may invoice parts of an order separately. Your order is subject to cancellation by Dell, at Dell's sole discretion. Unless you and Dell have agreed to a different discount, Dell's standard pricing policy for Dell™-branded systems, which include both hardware and services in one discounted price, allocates the discount off list price applicable to the service portion of the system to be equal to the overall calculated percentage discount off list price on the entire system. Dell is not responsible for pricing, typographical, or other errors, in any offer by Dell and reserves the right to cancel any orders resulting from such errors.

3 Shipping Charges; Taxes; Title; Risk of Loss.

Shipping and handling are additional unless otherwise expressly indicated at the time of sale. Loss or damage that occurs during shipping by a carrier selected by Dell is Dell's responsibility. Loss or damage that occurs during shipping by a carrier selected by you is your responsibility. You must notify Dell within 30 days of the date of your invoice or acknowledgement if you believe any part of your purchase is missing, wrong or damaged. Unless you provide Dell with a valid and correct tax exemption certificate applicable to your purchase of Product and the Product ship-to location, you are responsible for sales and other taxes associated with the order. Shipping dates are estimates only. Title to software will remain with the applicable licensor(s).

4 Warranties.

THE LIMITED WARRANTIES APPLICABLE TO DELL-BRANDED HARDWARE PRODUCT CAN BE FOUND AT <http://www.dell.com/policy/legal/warranty.htm> OR IN THE DOCUMENTATION DELL PROVIDES WITH THE PRODUCT. DELL MAKES NO WARRANTIES FOR SERVICE, SOFTWARE, OR NON-DELL BRANDED PRODUCT. SUCH PRODUCT IS PROVIDED BY DELL "AS IS." WARRANTY AND SERVICE FOR NON-DELL BRANDED PRODUCT, IF ANY, IS PROVIDED BY THE ORIGINAL MANUFACTURER, NOT BY DELL. DELL MAKES NO EXPRESS WARRANTIES EXCEPT THOSE STATED IN DELL'S APPLICABLE WARRANTY STATEMENT IN EFFECT ON THE DATE OF THE INVOICE, PACKING SLIP OR ACKNOWLEDGEMENT. WARRANTIES AND SERVICE WILL BE EFFECTIVE, AND DELL WILL BE OBLIGATED TO HONOR ANY SUCH WARRANTIES AND SERVICES, ONLY UPON DELL'S RECEIPT OF PAYMENT IN FULL FOR THE ITEM TO BE WARRANTED OR SERVICED.

5 Software.

All software is provided subject to the license agreement that is part of the software package and you agree that you will be bound by such license agreement.

6 Return Policies; Exchanges.

New and refurbished Product that you purchase directly from Dell (and not a third party) you may return or exchange only in accordance with Dell's return policy in effect on the date of the invoice or acknowledgement. Any returns or exchanges will be made in accordance with Dell's exchange policies in effect on the date of the return or exchange. You must contact us directly before you attempt to return Product to obtain a Return Material Authorization Number for you to include with your return. You must return Product to us in their original or equivalent packaging. You are responsible for risk of loss, shipping and handling fees for returning or exchanging Product. Additional fees may apply. Dell's return policy for Dell-branded Product can be found at: <http://www.dell.com/policy/legal/warranty.htm>. Non-Dell branded software and peripheral return policies can be found at: http://rcommerce.us.dell.com/rcomm/include/dw_policies.htm.

Refurbished Product return policies can be found at:

http://www.dell.com/us/en/dfh/topics/segtopic_nav_info_002_info.htm. If you fail to follow the return or exchange instructions and policies provided by Dell, Dell is not responsible whatsoever for Product that is lost, damaged, modified or otherwise processed for disposal or resale. If you are returning all components in an order, you will be credited the full amount paid for the order. At Dell's discretion, credit for partial returns may be less than invoice or individual component prices due to bundled or promotional pricing.

7 Changed or Discontinued Product.

Dell's policy is one of ongoing update and revision. Dell may revise and discontinue Product at any time without notice to you and this may affect information saved in your online "cart." Dell will ship Product that has the functionality and performance of the Product ordered, but changes between what is shipped and what is described in a specification sheet or catalog are possible. Parts used in repairing or servicing Product may be new, equivalent-to-new, or reconditioned.

8 Service and Support.

Service offerings may vary from Product to Product. If you purchase optional services and support from Dell, Dell and/or your third-party service provider will provide such service and support to you in the United States in accordance with the terms and conditions located at

http://www.dell.com/us/en/gen/services/service_service_contracts.htm or as mailed to you. You may contact Dell for more information, see <http://www1.us.dell.com/content/topics/segtopic.aspx/contact/contact?c=us&l=en&s=gen> for contact information. Dell and/or the third-party service provider may at their discretion, revise their general and optional service and support programs and the terms and conditions that govern them without prior notice to you. Dell has no obligation to provide service or support until Dell has received full payment for the Product or service/support contract you purchased. Dell is not obligated to provide service or support you purchase through a third party and not Dell.

9 Limitation of Liability.

DELL DOES NOT ACCEPT LIABILITY BEYOND THE REMEDIES SET FORTH HEREIN, INCLUDING BUT NOT LIMITED TO ANY LIABILITY FOR PRODUCT NOT BEING AVAILABLE FOR USE, LOST PROFITS, LOSS OF BUSINESS OR FOR LOST OR CORRUPTED DATA OR SOFTWARE, OR THE PROVISION OF SERVICES AND SUPPORT. EXCEPT AS EXPRESSLY PROVIDED HEREIN, DELL WILL NOT BE LIABLE FOR ANY CONSEQUENTIAL, SPECIAL, INDIRECT, OR PUNITIVE DAMAGES, EVEN IF ADVISED OF THE POSSIBILITY OF SUCH DAMAGES, OR FOR ANY CLAIM BY ANY THIRD PARTY. YOU AGREE THAT FOR ANY LIABILITY RELATED TO THE PURCHASE OF PRODUCT, DELL IS NOT LIABLE OR RESPONSIBLE FOR ANY AMOUNT OF DAMAGES ABOVE THE AMOUNT INVOICED FOR THE APPLICABLE PRODUCT. NOTWITHSTANDING ANYTHING IN THIS AGREEMENT TO THE CONTRARY, THE REMEDIES SET FORTH IN THIS AGREEMENT SHALL APPLY EVEN IF SUCH REMEDIES FAIL THEIR ESSENTIAL PURPOSE. DELL IS NOT LIABLE TO YOU FOR WARRANTIES, SUPPORT, OR SERVICE MADE BY OR PURCHASED FROM A THIRD PARTY AND NOT DIRECTLY FROM DELL. DELL IS NOT RESPONSIBLE FOR REPRESENTATIONS OR OMISSIONS MADE BY A THIRD PARTY.

10 Applicable Law; Not For Resale or Export.

You agree to comply with all applicable laws and regulations of the various states and of the United States. You agree and represent that you are buying only for your own internal use only, and not for resale or export. Dell has separate terms and conditions governing resale of Product by third parties and transactions outside the United States. Terms and conditions for resale are located at: <http://www.dell.com/policy/legal/termssofsale.htm>.

11 Governing Law.

THIS AGREEMENT AND ANY SALES THERE UNDER SHALL BE GOVERNED BY THE LAWS OF THE STATE OF TEXAS, WITHOUT REGARD TO CONFLICTS OF LAWS RULES.

12 Headings.

The section headings used herein are for convenience of reference only and do not form a part of these terms and conditions, and no construction or inference shall be derived there from.

13 Binding Arbitration.

ANY CLAIM, DISPUTE, OR CONTROVERSY (WHETHER IN CONTRACT, TORT, OR OTHERWISE, WHETHER PREEXISTING, PRESENT OR FUTURE, AND INCLUDING STATUTORY, COMMON LAW, INTENTIONAL TORT AND EQUITABLE CLAIMS) BETWEEN CUSTOMER AND DELL, its agents, employees, principals, successors, assigns, affiliates (collectively for purposes of this paragraph, "Dell") arising from or relating to this Agreement, its interpretation, or the breach, termination or validity thereof, the relationships which result from this Agreement (including, to the full extent permitted by applicable law, relationships with third parties who are not signatories to this Agreement), Dell's advertising, or any related purchase SHALL BE RESOLVED EXCLUSIVELY AND FINALLY BY BINDING ARBITRATION ADMINISTERED BY THE NATIONAL ARBITRATION FORUM (NAF) under its Code of Procedure then in effect (available via the Internet at <http://www.arb-forum.com> → , or via telephone at 1-800-474-2371). The arbitration will be limited solely to the dispute or controversy between customer and Dell. NEITHER CUSTOMER NOR DELL SHALL BE ENTITLED TO JOIN OR CONSOLIDATE CLAIMS BY OR AGAINST OTHER CUSTOMERS, OR ARBITRATE ANY CLAIM AS A REPRESENTATIVE OR CLASS ACTION OR IN A PRIVATE ATTORNEY GENERAL CAPACITY. This transaction involves interstate commerce, and this provision shall be governed by the Federal Arbitration Act 9 U.S.C. sec. 1-16 (FAA). Any award of the arbitrator(s) shall be final and binding on each of the parties, and may be entered as a judgment in any court of competent jurisdiction. Dell will be responsible for paying any arbitration filing fees and fees required to obtain a hearing to the extent such fees exceed the amount of the filing fee for initiating a claim in the court of general jurisdiction in the state in which you reside. Each party shall pay for its own costs and attorneys' fees, if any. However, if any party prevails on a statutory claim that affords the prevailing party attorneys' fees, or if there is a written agreement providing for fees, the Arbitrator may award reasonable fees to the prevailing party, under the standards for fee shifting provided by law. Information may be obtained and claims may be filed with the NAF at P.O. Box 50191, Minneapolis, MN 55405. (REV 4/04)

Limited Warranties and Return Policy

Dell-branded hardware products purchased in the U.S. or Canada come with either a 90-day, 1-year, 2-year, 3-year, or 4-year limited warranty. To determine which warranty came with your hardware product(s), see your packing slip or invoice. The following sections describe the limited warranties and return policy for the U.S., the limited warranties and return policy for Canada and the manufacturer guarantee for Latin America and the Caribbean.

Limited Warranty for Dell-Branded Hardware Products (U.S. Only)

Dell-branded hardware products purchased in the U.S. come with either a 90-day, 1-year, 2-year, 3-year, or 4-year limited warranty depending on the product purchased. To determine which warranty came with your hardware product(s), see your packing slip or invoice.

What is covered by this limited warranty?

This limited warranty covers defects in materials and workmanship in your—our end-user customer's—Dell-branded hardware products, including Dell-branded peripheral products.

What is not covered by this limited warranty?

This limited warranty does not cover:

- Software, including the operating system and software added to the Dell-branded hardware products through our factory-integration system, third-party software, or the reloading of software
- Non-Dell-branded and Solution Provider Direct products and accessories
- Problems that result from:
 - External causes such as accident, abuse, misuse, or problems with electrical power
 - Servicing not authorized by Dell
 - Usage that is not in accordance with product instructions
 - Failure to follow the product instructions or failure to perform preventive maintenance
 - Problems caused by using accessories, parts, or components not supplied by Dell
- Products with missing or altered Service Tags or serial numbers
- Products for which Dell has not received payment

THIS WARRANTY GIVES YOU SPECIFIC LEGAL RIGHTS, AND YOU MAY ALSO HAVE OTHER RIGHTS WHICH VARY FROM STATE TO STATE (OR JURISDICTION TO JURISDICTION). DELL'S RESPONSIBILITY FOR MALFUNCTIONS AND DEFECTS IN HARDWARE IS LIMITED TO REPAIR AND REPLACEMENT AS SET FORTH IN THIS WARRANTY STATEMENT. ALL EXPRESS AND IMPLIED WARRANTIES FOR THE PRODUCT, INCLUDING BUT NOT LIMITED TO ANY IMPLIED WARRANTIES AND CONDITIONS OF MERCHANTABILITY AND FITNESS FOR A PARTICULAR PURPOSE, ARE LIMITED IN TIME TO THE TERM OF THE LIMITED WARRANTY PERIOD REFLECTED ON YOUR PACKING SLIP OR INVOICE. NO WARRANTIES, WHETHER EXPRESS OR IMPLIED, WILL APPLY AFTER THE LIMITED WARRANTY PERIOD HAS EXPIRED. SOME STATES DO NOT ALLOW LIMITATIONS ON HOW LONG AN IMPLIED WARRANTY LASTS, SO THIS LIMITATION MAY NOT APPLY TO YOU.

WE DO NOT ACCEPT LIABILITY BEYOND THE REMEDIES PROVIDED FOR IN THIS LIMITED WARRANTY OR FOR CONSEQUENTIAL OR INCIDENTAL DAMAGES, INCLUDING, WITHOUT LIMITATION, ANY LIABILITY FOR THIRD-PARTY CLAIMS AGAINST YOU FOR DAMAGES, FOR PRODUCTS NOT BEING AVAILABLE FOR USE, OR FOR LOST DATA OR LOST SOFTWARE. OUR LIABILITY WILL BE NO MORE THAN THE AMOUNT YOU PAID FOR THE PRODUCT THAT IS THE SUBJECT OF A CLAIM. THIS IS THE MAXIMUM AMOUNT FOR WHICH WE ARE RESPONSIBLE.

SOME STATES DO NOT ALLOW THE EXCLUSION OR LIMITATION OF INCIDENTAL OR CONSEQUENTIAL DAMAGES, SO THE ABOVE LIMITATION OR EXCLUSION MAY NOT APPLY TO YOU.

How long does this limited warranty last?

This limited warranty lasts for the time period indicated on your packing slip or invoice, except for the following Dell-branded hardware:

- Portable computer batteries carry a 1-year limited warranty.
- Projector lamps carry a 90-day limited warranty.
- Memory carries a lifetime limited warranty.
- Monitors carry the longer of either a 3-year limited warranty or the remainder of the warranty for the Dell™ computer to which the monitor will be connected.
- PDAs, MP3 players, earphones, remote inline controls, and AC adapters carry a 1-year limited warranty.
- Other add-on hardware carries the longer of either a 1-year limited warranty for new parts and a 90-day limited warranty for reconditioned parts or, for both new and reconditioned parts, the remainder of the warranty for the Dell computer on which such parts are installed.

The limited warranty on all Dell-branded products begins on the date of the packing slip or invoice. The warranty period is not extended if we repair or replace a warranted product or any parts. Dell may change the availability of limited warranties, at its discretion, but any changes will not be retroactive.

What do I do if I need warranty service?

Before the warranty expires, please call us at the relevant number listed in the following table. Please also have your Dell Service Tag or order number available.

Web Support	support.dell.com/ContactUs/ContactUsHome.aspx?c=us&l=en&s=gen
Individual Home Consumers:	U.S. Only
Technical Support	1-800-624-9896
Customer Service	1-800-624-9897
Individual Home Consumers who purchased through an Employee Purchase Program:	
Technical Support and Customer Service	1-800-822-8965
Home and Small Business Commercial Customers:	
Technical Support and Customer Service	1-800-456-3355
Medium, Large, or Global Commercial Customers, Healthcare Customers, and Value-Added Resellers (VARs):	
Technical Support and Customer Service	1-800-822-8965
Government and Education Customers:	
Technical Support and Customer Service	1-800-234-1490
Dell-Branded Memory	1-888-363-5150

What will Dell do?

During the 90 days of the 90-day limited warranty and the first year of all other limited warranties: During the 90 days of the 90-day limited warranty and the first year of all other limited warranties, we will repair any Dell-branded hardware products returned to us that prove to be defective in materials or workmanship. If we are not able to repair the product, we will replace it with a comparable product that is new or refurbished.

When you contact us, we will issue a Return Material Authorization Number for you to include with your return. You must return the products to us in their original or equivalent packaging, prepay shipping charges, and insure the shipment or accept the risk if the product is lost or damaged in shipment. We will return the repaired or replacement products to you. We will pay to ship the repaired or replaced products to you if you use an address in the United States (excluding Puerto Rico and U.S. possessions and territories). Otherwise, we will ship the product to you freight collect.

If we determine that the issue is not covered under this warranty, we will notify you and inform you of service alternatives that are available to you on a fee basis.



NOTE: Before you ship the product(s) to us, make sure to back up the data on the hard drive(s) and any other storage device(s) in the product(s). Remove any confidential, proprietary, or personal information and removable media such as floppy disks, CDs, or PC Cards. We are not responsible for any of your confidential, proprietary, or personal information; lost or corrupted data; or damaged or lost removable media.

During the remaining years: For the remaining period of the limited warranty, we will replace any defective part with new or refurbished parts, if we agree that it needs to be replaced. When you contact us, we will require a valid credit card number at the time you request a replacement part, but we will not charge you for the replacement part as long as you return the original part to us within 30 days after we ship the replacement part to you. If we do not receive the original part within 30 days, we will charge to your credit card the then-current standard price for that part.

We will pay to ship the part to you if you use an address in the United States (excluding Puerto Rico and U.S. possessions and territories). Otherwise, we will ship the part freight collect. We will also include a prepaid shipping container with each replacement part for your use in returning the replaced part to us.



NOTE: Before you replace parts, make sure to back up the data on the hard drive(s) and any other storage device(s) in the product(s). We are not responsible for lost or corrupted data.

What if I purchased a service contract?

If your service contract is with Dell, service will be provided to you under the terms of the service agreement. Please refer to that contract for details on how to obtain service.

If you purchased through us a service contract with one of our third-party service providers, please refer to that contract for details on how to obtain service.

How will you fix my product?

We use new and refurbished parts made by various manufacturers in performing warranty repairs and in building replacement parts and systems. Refurbished parts and systems are parts or systems that have been returned to Dell, some of which were never used by a customer. All parts and systems are inspected and tested for quality. Replacement parts and systems are covered for the remaining period of the limited warranty for the product you bought. Dell owns all parts removed from repaired products.

May I transfer the limited warranty?

Limited warranties on systems may be transferred if the current owner transfers ownership of the system and records the transfer with us. The limited warranty on Dell-branded memory may not be transferred. You may record your transfer by going to Dell's website:

- If you are an Individual Home Consumer, go to www.dell.com/us/en/dhs/topics/sbtopic_015_ccare.htm
- If you are a Home Office, Small, Medium, Large, or Global Commercial Customer, go to www.dell.com/us/en/biz/topics/sbtopic_ccare_nav_015_ccare.htm
- If you are a Government, Education, or Healthcare Customer, or an Individual Home Consumer who purchased through an Employee Purchase Program, go to www.dell.com/us/en/pub/topics/sbtopic_015_ccare.htm

If you do not have Internet access, call your customer care representative or call 1-800-624-9897.

All requests to transfer ownership are at Dell's sole discretion. All such transfers will be subject to the terms and conditions of the original service or limited warranty agreement and Dell's terms and conditions of sale located at www.dell.com. Dell cannot guarantee the authenticity of the products, limited warranties, service or support, or the accuracy of the listings of products you purchase from a third party.

Total Satisfaction Return Policy (U.S. Only)

We value our relationship with you and want to make sure that you are satisfied with your purchases. That is why we offer a Total Satisfaction return policy for most products that you, the end-user customer, purchase directly from Dell. Under this policy, you may return to Dell products that you purchased directly from Dell for a credit or a refund of the purchase price paid, less shipping and handling and applicable return fees as follows:

New Hardware Products and Accessories — Unless you have a separate agreement with Dell, all hardware, accessories, peripherals, parts, and unopened software still in its/their sealed package, excluding the products listed below, may be returned within twenty-one (21) days from the date on the packing slip or invoice.

Exclusions from the foregoing return policy:

- New Dell PowerEdge™, Dell PowerConnect™, and Dell PowerVault™ products (excluding PowerVault 160T tape libraries) may be returned within thirty (30) days from the date on the packing slip or invoice, except that new PowerEdge **SC** servers and n series products purchased from the Small and Medium Business Sales Division may only be returned within fourteen (14) days from the date on the packing slip or invoice.
- Application software or an operating system that has been installed by Dell may not be returned unless you return the entire computer under the 21-day return policy, if applicable to your purchase (if not applicable to your purchase, you may not return application software or an operating system).
- Nondefective third-party and Dell-branded software, peripheral, electronics and accessory products (for example: televisions, printers, projectors, MP3 players, PDAs, battery chargers, un-preinstalled third-party software, wireless cards/access points/routers), including but not limited to those sold by or through Dell's "Software & Peripherals" or "Electronics & Accessories" groups, may be returned within twenty-one (21) days from the date on the packing slip or invoice, but a fifteen percent (15%) return fee may be deducted from any refund or credit.
- Dell | EMC storage products, EMC-branded products, Unisys-branded products, PowerVault 160T tape libraries, enterprise software, non-Dell-branded enterprise products, software and/or software licenses, or any non-Dell-customized hardware and/or software product(s) may not be returned at any time.

Reconditioned or Refurbished Dell-Branded Hardware Products and Parts — All reconditioned or refurbished PowerEdge, PowerConnect, and PowerVault products may be returned within thirty (30) days from the date on the packing slip or invoice. All other reconditioned or refurbished Dell-branded hardware products and parts may be returned within fourteen (14) days of the date on the packing slip or invoice.

How to Return — To return products, e-mail or call Dell customer service to receive a Credit Return Authorization Number within the return policy period applicable to the product you want to return. You must obtain a Credit Return Authorization Number in order to return the product. See "Contacting Dell" or "Getting Help" in your customer documentation (or go to www.dell.com/us/en/gen/contact.htm) to find the appropriate contact information for obtaining customer assistance.

You must ship the products to Dell within five (5) days of the date that Dell issues the Credit Return Authorization Number. You must also return the products to Dell in their original packaging, in as-new condition along with any media, documentation, and all other items that were included in the original shipment, prepay shipping charges, and insure the shipment or accept the risk of loss or damage during shipment.



NOTE: Before you ship the product(s) to us, make sure to back up the data on the hard drive(s) and any other storage device(s) in the product(s). Remove any confidential, proprietary, or personal information and removable media such as floppy disks, CDs, or PC Cards. We are not responsible for any of your confidential, proprietary, or personal information; lost or corrupted data; or damaged or lost removable media.

Limited Warranty Terms for Dell-Branded Hardware Products (Canada Only)

Dell-branded hardware products purchased in Canada come with either a 90-day, 1-year, 2-year, 3-year, or 4-year limited warranty depending on the product purchased. To determine which warranty came with your hardware product(s), see your packing slip or invoice.

What is covered by this limited warranty?

This limited warranty covers defects in materials and workmanship in your—our end-user customer's—Dell-branded hardware products, including Dell-branded peripheral products.

What is not covered by this limited warranty?

This limited warranty does not cover:

- Software, including the operating system and software added to the Dell-branded hardware products through our factory-integration system, or the reloading of the software
- Non-Dell-branded and Solution Provider Direct products and accessories
- Problems that result from:
 - External causes such as accident, abuse, misuse, or problems with electrical power
 - Servicing not authorized by Dell
 - Usage that is not in accordance with product instructions
 - Failure to follow the product instructions or failure to perform preventive maintenance
 - Problems caused by using accessories, parts, or components not supplied by Dell
- Products with missing or altered Service Tags or serial numbers
- Products for which Dell has not received payment

THIS WARRANTY GIVES YOU SPECIFIC LEGAL RIGHTS, AND YOU MAY ALSO HAVE OTHER RIGHTS WHICH VARY FROM PROVINCE TO PROVINCE. DELL'S RESPONSIBILITY FOR MALFUNCTIONS AND DEFECTS IN PRODUCT IS LIMITED TO REPAIR AND REPLACEMENT AS SET FORTH IN THIS WARRANTY STATEMENT, FOR THE TERM OF THE WARRANTY PERIOD REFLECTED ON YOUR PACKING SLIP OR INVOICE. EXCEPT FOR THE EXPRESS WARRANTIES CONTAINED IN THIS WARRANTY STATEMENT, DELL DISCLAIMS ALL OTHER WARRANTIES AND CONDITIONS, EXPRESS OR IMPLIED, INCLUDING WITHOUT LIMITATION IMPLIED WARRANTIES AND CONDITIONS OF MERCHANTABILITY AND FITNESS FOR A PARTICULAR PURPOSE, STATUTORY OR OTHERWISE.

SOME PROVINCES DO NOT ALLOW THE EXCLUSION OF CERTAIN IMPLIED WARRANTIES OR CONDITIONS, OR LIMITATIONS ON HOW LONG AN IMPLIED WARRANTY OR CONDITION LASTS. THEREFORE, THE FOREGOING EXCLUSIONS AND LIMITATIONS MAY NOT APPLY TO YOU.

WE DO NOT ACCEPT LIABILITY BEYOND THE REMEDIES PROVIDED FOR IN THIS WARRANTY STATEMENT OR FOR SPECIAL, INDIRECT, CONSEQUENTIAL, OR INCIDENTAL DAMAGES, INCLUDING, WITHOUT LIMITATION, ANY LIABILITY FOR THIRD-PARTY CLAIMS AGAINST YOU FOR DAMAGES, FOR PRODUCTS NOT BEING AVAILABLE FOR USE, OR FOR LOST DATA OR LOST SOFTWARE. OUR LIABILITY WILL BE NO MORE THAN THE AMOUNT YOU PAID FOR THE PRODUCT THAT IS THE SUBJECT OF A CLAIM. THIS IS THE MAXIMUM AMOUNT FOR WHICH WE ARE RESPONSIBLE.

SOME PROVINCES DO NOT ALLOW THE EXCLUSION OR LIMITATION OF SPECIAL, INDIRECT, INCIDENTAL, OR CONSEQUENTIAL DAMAGES, SO THE ABOVE LIMITATION OR EXCLUSION MAY NOT APPLY TO YOU.

How long does this limited warranty last?

This limited warranty lasts for the time period indicated on your packing slip or invoice, except that the limited warranty on Dell-branded batteries lasts only 1 year and the limited warranty on the lamps for Dell-branded projectors lasts only 90 days. The limited warranty begins on the date of the packing slip or invoice. The warranty period is not extended if we repair or replace a warranted product or any parts. Dell may change the terms and availability of limited warranties, at its discretion, but any changes will not be retroactive (that is, the warranty terms in place at the time of purchase will apply to your purchase).

What do I do if I need warranty service?

Before the warranty expires, please call us at the relevant number listed in the following table. Please also have your Dell Service Tag or order number available.

Web Support	support.dell.com/ContactUs/ContactUsHome.aspx?c=us&l=en&s=gen
Individual Home Consumers; Home Office and Small Business Customers:	Canada Only
Technical Support and Customer Service	1-800-847-4096
Medium, Large, and Global Commercial Customers; Government, Education, and Healthcare Customers; and Value-Added Resellers (VARs):	
Technical Support	1-800-387-5757
Customer Service	1-800-326-9463
Government or Education Customers, or Individual Home Consumers who purchased through an Employee Purchase Program:	
Technical Support	1-800-387-5757
Customer Service	1-800-326-9463 (Extension 8221 for Individual Consumers)
Dell-Branded Memory	1-888-363-5150
Printers, Wireless, Projection Devices and TVs, Handhelds, and Digital Jukebox	1-877-335-5767

What will Dell do?

During the 90 days of the 90-day limited warranty and the first year of all other limited warranties: During the 90 days of the 90-day limited warranty and the first year of all other limited warranties, we will repair any Dell-branded hardware products returned to us that prove to be defective in materials or workmanship. If we are not able to repair the product, we will replace it with a comparable product that is new or refurbished.

When you contact us, we will issue a Return Material Authorization Number for you to include with your return. You must return the products to us in their original or equivalent packaging, prepay shipping charges, and insure the shipment or accept the risk if the product is lost or damaged in shipment. We will return the repaired or replacement products to you. We will pay to ship the repaired or replaced products to you if you use an address in Canada. Otherwise, we will ship the product to you freight collect.

If we determine that the issue is not covered under this warranty, we will notify you and inform you of service alternatives that are available to you on a fee basis.



NOTE: Before you ship the product(s) to us, make sure to back up the data on the hard drive(s) and any other storage device(s) in the product(s). Remove any confidential, proprietary, or personal information and removable media such as floppy disks, CDs, or PC Cards. We are not responsible for any of your confidential, proprietary, or personal information; lost or corrupted data; or damaged or lost removable media.

During the remaining years following the first year of all limited warranties: We will replace any defective part with new or refurbished parts, if we agree that it needs to be replaced. When you contact us, we will require a valid credit card number at the time you request a replacement part, but we will not charge you for the replacement part as long as you return the original part to us within 30 days after we ship the replacement part to you. If we do not receive the original part within 30 days, we will charge to your credit card the then-current standard price for that part.

We will pay to ship the part to you if you use an address in Canada. Otherwise, we will ship the part freight collect. We will also include a prepaid shipping container with each replacement part for your use in returning the replaced part to us.



NOTE: Before you replace parts, make sure to back up the data on the hard drive(s) and any other storage device(s) in the product(s). We are not responsible for lost or corrupted data.

What if I purchased a service contract?

If your service contract is with Dell, service will be provided to you under the terms of the service contract. Please refer to that contract for details on how to obtain service. Dell's service contracts can be found online at www.dell.ca or by calling Customer Care at 1-800-847-4096. If you purchased through us a service contract with one of our third-party service providers, please refer to that contract (mailed to you with your packing slip or invoice) for details on how to obtain service.

How will you fix my product?

We use new and refurbished parts made by various manufacturers in performing warranty repairs and in building replacement parts and systems. Refurbished parts and systems are parts or systems that have been returned to Dell, some of which were never used by a customer. All parts and systems are inspected and tested for quality. Replacement parts and systems are covered for the remaining period of the limited warranty for the product you bought. Dell owns all parts removed from repaired products.

May I transfer the limited warranty?

Limited warranties on systems may be transferred if the current owner transfers ownership of the system and records the transfer with us. The limited warranty on Dell-branded memory may not be transferred. You may record your transfer by going to Dell's website.

- For Canada-purchased computers (in-country transfers) and to transfer from one customer to another, go to www.dell.ca/ca/en/gen/topics/segtopic_ccare_nav_013_ccare.htm
- For out-of-country transfers (outside of the original country of purchase), go to www.dell.com/us/en/biz/topics/sbtopic_ccare_nav_016_ccare.htm

If you do not have Internet access, call Dell at 1-800-847-4096 (Home Consumer customers) or 1-800-326-9463 (Corporate Commercial or Government customers).

All requests to transfer ownership are at Dell's sole discretion. All such transfers will be subject to the terms and conditions of the original service or limited warranty agreement and Dell's terms and conditions of sale located at www.dell.com. Dell cannot guarantee the authenticity of the products, limited warranties, service or support, or the accuracy of the listings of products you purchase from a third party.

Total Satisfaction Return Policy (Canada Only)

If you are an end-user customer who bought new products directly from Dell, you may return them to Dell up to 30 days after you receive them for a refund or credit of the product purchase price. If you are an end-user customer who bought reconditioned or refurbished products from Dell, you may return them to Dell within 14 days after the date on the packing slip or invoice for a refund or credit of the product purchase price. In either case, the refund or credit will not include any shipping and handling charges shown on your packing slip or invoice and will be subject to a fifteen percent (15%) restocking fee, unless otherwise prohibited by law. If you are an organization that bought the products under a written agreement with Dell, the agreement may contain different terms for the return of products than specified by this policy.

To return products, you must call Dell Customer Service at 1-800-847-4096 to receive a Credit Return Authorization Number. To expedite the process of your refund or credit, Dell expects you to return the products to Dell in their original packaging within 5 days of the date that Dell issues the Credit Return Authorization Number. You must also prepay shipping charges and insure the shipment or accept the risk of loss or damage during shipment. You may return software for a refund or credit only if the sealed package containing the diskette(s) or CD(s) is unopened. Returned products must be in as-new condition, and all of the manuals, diskette(s), CD(s), power cables, and other items included with a product must be returned with it. For customers who want to return, for refund or credit only, either application or operating system software that has been installed by Dell, the whole system must be returned, along with any media and documentation that may have been included in the original shipment.

The "Total Satisfaction" Return Policy does not apply to Dell | EMC storage products. It also does not apply to products purchased through Dell's Software and Peripherals division. For those products, please instead refer to Dell's Software and Peripheral's then-current return policy (see the following section, "Dell Software and Peripherals [Canada Only]").

Dell™ Software and Peripherals (Canada Only)

Third-Party Software and Peripherals Products

Similar to other resellers of software and peripherals, Dell does not warrant third-party products. Third-party software and peripheral products are covered by the warranties provided by the original manufacturer or publisher only. Third-party manufacturer warranties vary from product to product. Consult your product documentation for specific warranty information. More information may also be available from the manufacturer or publisher.

While Dell offers a wide selection of software and peripheral products, we do not specifically test or guarantee that all of the products we offer work with any or all of the various models of Dell computers, nor do we test or guarantee all of the products we sell on the hundreds of different brands of computers available today. If you have questions about compatibility, we recommend and encourage you to contact the third-party software and peripheral product manufacturer or publisher directly.

Dell-Branded Peripheral Products

Dell does provide a limited warranty for new Dell-branded peripheral products (products for which Dell is listed as the manufacturer) such as monitors, batteries, memory, docking stations, and projectors. To determine which limited warranty applies to the product you purchased, see the Dell packing slip or invoice and/or the product documentation that accompanied your product. Descriptions of Dell's limited warranties are described in preceding sections.

1-Year End-User Manufacturer Guarantee (Latin America and the Caribbean Only)

Guarantee

Dell Inc. ("Dell") warrants to the end user in accordance with the following provisions that its branded hardware products, purchased by the end user from a Dell company or an authorized Dell distributor in Latin America or the Caribbean, will be free from defects in materials, workmanship, and design affecting normal use, for a period of 1 year from the original purchase date. Products for which proper claims are made will, at Dell's option, be repaired or replaced at Dell's expense. Dell owns all parts removed from repaired products. Dell uses new and reconditioned parts made by various manufacturers in performing repairs and building replacement products.

Exclusions

This Guarantee does not apply to defects resulting from: improper or inadequate installation, use, or maintenance; actions or modifications by unauthorized third parties or the end user; accidental or willful damage; or normal wear and tear.

Making a Claim

Claims must be made in Latin America or the Caribbean by contacting the Dell point of sale within the guarantee period. The end user must always supply proof of purchase, indicating name and address of the seller, date of purchase, model and serial number, name and address of the customer, and details of symptoms and configuration at the time of malfunction, including peripherals and software used. Otherwise, Dell may refuse the guarantee claim. Upon diagnosis of a warranted defect, Dell will make arrangements and pay for ground freight and insurance to and from Dell's repair/replacement center. The end user must ensure that the defective product is available for collection properly packed in original or equally protective packaging together with the details listed above and the return number provided to the end user by Dell.

Limitation and Statutory Rights

Dell makes no other warranty, guarantee or like statement other than as explicitly stated above, and this Guarantee is given in place of all other guarantees whatsoever, to the fullest extent permitted by law. In the absence of applicable legislation, this Guarantee will be the end user's sole and exclusive remedy against Dell or any of its affiliates, and neither Dell nor any of its affiliates shall be liable for loss of profit or contracts, or any other indirect or consequential loss arising from negligence, breach of contract, or howsoever.

This Guarantee does not impair or affect mandatory statutory rights of the end user against and/or any rights resulting from other contracts concluded by the end user with Dell and/or any other seller.

Dell World Trade LP

One Dell Way, Round Rock, TX 78682, USA

Dell Computadores do Brasil Ltda (CNPJ No. 72.381.189/0001-10)

Avenida Industrial Belgraf, 400
92990-000 - Eldorado do Sul – RS - Brasil

Dell Computer de Chile Ltda

Coyancura 2283, Piso 3- Of.302,
Providencia, Santiago - Chile

Dell Computer de Colombia Corporation

Carrera 7 #115-33 Oficina 603
Bogota, Colombia

Dell Computer de Mexico SA de CV

Paseo de la Reforma 2620 - 11° Piso
Col. Lomas Altas
11950 México, D.F.

Dell Inc.

Ink and Toner Cartridges Limited Warranties

The following sections describe the limited warranty for ink and toner cartridges for the U.S., Canada, and Latin America. Refer to the appropriate limited warranty accordingly.

Ink and Toner Cartridges Limited Warranty (U.S. and Canada Only)

Dell Inc. warrants to the original purchaser of genuine Dell-branded toner cartridges that they will be free from defects in material and workmanship for the life of the cartridge and that for genuine Dell-branded ink cartridges they will be free from defects in material and workmanship for two years beginning on the date of invoice. If this product proves defective in either material or workmanship, it will be replaced without charge during the limited warranty period if returned to Dell. You must first call our toll-free number to get your return authorization. In the U.S., call 1-800-822-8965; in Canada, call 1-800-387-5757. If we are not able to replace the product because it has been discontinued or is not available, we will either replace it with a comparable product or reimburse you for the cartridge purchase cost, at Dell's sole option. This limited warranty does not apply to ink or toner cartridges that have been refilled or improperly stored or due to problems resulting from misuse, abuse, accident, neglect, mishandling, incorrect environments, or wear from ordinary use.

THIS WARRANTY GIVES YOU SPECIFIC LEGAL RIGHTS, AND YOU MAY ALSO HAVE OTHER RIGHTS WHICH VARY FROM STATE TO STATE (OR JURISDICTION TO JURISDICTION). DELL'S RESPONSIBILITY FOR MALFUNCTIONS AND DEFECTS IN HARDWARE IS LIMITED TO REPLACEMENT AS SET FORTH IN THIS WARRANTY STATEMENT. FOR CANADIAN CUSTOMERS, EXCEPT FOR THE EXPRESS WARRANTIES CONTAINED IN THIS WARRANTY STATEMENT, DELL DISCLAIMS ALL OTHER WARRANTIES AND CONDITIONS, EXPRESS OR IMPLIED, STATUTORY OR OTHERWISE, FOR THE PRODUCT. FOR U.S. CUSTOMERS, ALL EXPRESS AND IMPLIED WARRANTIES FOR THE PRODUCT, INCLUDING BUT NOT LIMITED TO ANY IMPLIED WARRANTIES AND CONDITIONS OF MERCHANTABILITY AND FITNESS FOR A PARTICULAR PURPOSE ARE LIMITED IN TIME TO THE TERM OF THIS LIMITED WARRANTY. NO WARRANTIES, WHETHER EXPRESS OR IMPLIED, WILL APPLY AFTER THE LIMITED WARRANTY PERIOD HAS EXPIRED. SOME STATES OR JURISDICTIONS DO NOT ALLOW THE EXCLUSION OF CERTAIN IMPLIED WARRANTIES OR CONDITIONS, OR LIMITATIONS ON HOW LONG AN IMPLIED WARRANTY OR CONDITION LASTS, SO THIS LIMITATION MAY NOT APPLY TO YOU. THIS WARRANTY COVERAGE TERMINATES IF YOU SELL OR OTHERWISE TRANSFER THIS PRODUCT TO ANOTHER PARTY.

DELL DOES NOT ACCEPT LIABILITY BEYOND THE REMEDIES PROVIDED FOR IN THIS LIMITED WARRANTY OR FOR SPECIAL, INDIRECT, CONSEQUENTIAL OR INCIDENTAL DAMAGES, INCLUDING, WITHOUT LIMITATION, ANY LIABILITY FOR THIRD-PARTY CLAIMS AGAINST YOU FOR DAMAGES, FOR PRODUCTS NOT BEING AVAILABLE FOR USE, OR FOR LOST DATA OR LOST SOFTWARE. DELL'S LIABILITY WILL BE NO MORE THAN THE AMOUNT YOU PAID FOR THE PRODUCT THAT IS THE SUBJECT OF A CLAIM. THIS IS THE MAXIMUM AMOUNT FOR WHICH DELL IS RESPONSIBLE.

SOME STATES OR JURISDICTIONS DO NOT ALLOW THE EXCLUSION OR LIMITATION OF SPECIAL, INDIRECT, INCIDENTAL OR CONSEQUENTIAL DAMAGES, SO THE ABOVE LIMITATION OR EXCLUSION MAY NOT APPLY TO YOU.

Ink and Toner Cartridges Limited Warranty (Latin America Only)

Dell Inc. warrants to the original purchaser of genuine Dell-branded toner cartridges that the cartridges will be free from defects resulting from material or manufacturing process for the life of the cartridge. For the original purchaser of genuine Dell-branded ink cartridges, Dell warrants that the cartridges will be free from defects resulting from material or manufacturing process for one year beginning from the date of delivery.

If this product presents defects resulting from either material or manufacturing process, it will be replaced without charge during the limited warranty period if returned to Dell.

In order to obtain the necessary information to enable the replacement, call the appropriate toll-free number. In Mexico, call 001-877-533-6230; in Puerto Rico, call 1-877-839-5123. In cases in which either the production of the cartridge has been discontinued or the cartridge is not available, Dell reserves the right, at its sole discretion, to choose between replacing it by a similar product or reimbursing you for the purchase cost.

This limited warranty does not apply to ink or toner cartridges that have been refilled or to defects resulting from misuse, abuse, accident, negligence, mishandling, improper storage or exposure to inappropriate environments.

Dell's liability for the malfunction or defect of hardware after the period of the legal warranty (and specifically the period of the legal warranty of defective products stated in the consumer protections rules), is limited to either the substitution of the product or the reimbursement as stated above. This warranty coverage terminates if you sell or otherwise transfer this product to a third party.

Dell does not accept any additional liability for patrimonial, emotional or any other kind of damage caused to the consumer and/or to a third party, which exceeds the established liability either in this limited warranty or in legal rules that may apply.

Dette skema er alene anvendeligt for norske konsumenter

ANGREFRISTSKJEMA

Kjære Kunde.

Du har kjøpt produkt fra DELL (Produkt) som vi har sendt deg med frakt. Dette defineres som en distansavtale og underlegges normalt angrefristloven som gir deg 14 dagers returrett.

Dersom du ikke er fornøyd med de Produkt du har mottatt, eller av andre årsaker ikke ønsker å beholde din Produkt ber vi deg fylle ut skjemaet nedenfor og legger dette i returpakken.

Generelle betingelser for retur:

- 1 Returskjemaet under må være utfylt og vedlagt returpakken for at angrefristen gjelder.
- 2 Angrefristen gjelder fra den dag pakken mottas fra transportør. Senest på dag 14 fra utlevering av dit Produkt skal skriftlig meddelelse til DELL om utnyttelse av angre retten gives. Bekreftelse eller kvittering fra transportør med dato for utleveringen må ligge ved returskjemaet nedenfor. Kopi av fakturaen fra DELL skal også være vedlagt. DELL foranstalter avhenting af Produkt etter meddelelse om utnyttelse af angre retten.
- 3 Produkt må tilbakeleveres i original emballasje uten at denne er skadet. Produkt må fremstå som nye og ikke være tatt i bruk.
- 4 Dersom retur skjer p.g.a. defekt eller mangel ved varen må feilbeskrivelse fra deg følge med.
- 5 Du er ansvarlig for Produkt til den er utlevert fra transportør.
- 6 DELL tilbakebetaler ikke frakt som påløp ved utsendelse eller retur av varen.
- 7 Det innrømmes ikke retur på programvare, med mindre dette skjer p.g.a. at du ikke kan akseptere lisensbetingelsene. Dette av hensyn til kopiering og lisensregler.
- 8 Skriver gis kun retur på dersom den er ubrukt, d.v.s. at toner/blekkpatron ikke er åpnet.
- 9 Angrefristen gjelder **ikke** ved næringskjøp.

Kundens navn:

Faktura nummer: Ordrenummer:

Kontonummer: |_|_|_|_|_|_|_|_|_|_|_|_|_|_|_|_| (Manglende kontonummer medfører gebyr!)

Jeg bekrefter med dette at det jeg returnerer er i samme stand som da jeg mottok det.

Vedlagt er kvittering fra transportør som viser når jeg mottok forsendelsen samt kopi av fakturaen fra DELL som er angitt med nummer over.

Jeg er kjent med betingelsene for returretten og har meddelt at jeg ønsker at returnere iht. til disse innen de 14 dagene jeg har som frist til dette.

Sted:

Dato:

Signatur:

Regulatory Notices

Electromagnetic Interference (EMI) is any signal or emission, radiated in free space or conducted along power or signal leads, that endangers the functioning of a radio navigation or other safety service or seriously degrades, obstructs, or repeatedly interrupts a licensed radio communications service. Radio communications services include but are not limited to AM/FM commercial broadcast, television, cellular services, radar, air-traffic control, pager, and Personal Communication Services (PCS). These licensed services, along with unintentional radiators such as digital devices, including printers, contribute to the electromagnetic environment.

Electromagnetic Compatibility (EMC) is the ability of items of electronic equipment to function properly together in the electronic environment. While this printer has been designed and determined to be compliant with regulatory agency limits for EMI, there is no guarantee that interference will not occur in a particular installation. If this equipment does cause interference with radio communications services, which can be determined by turning the equipment off and on, you are encouraged to try to correct the interference by one or more of the following measures:

- Reorient the receiving antenna.
- Relocate the printer with respect to the receiver.
- Move the printer away from the receiver.
- Plug the printer into a different outlet so that the printer and the receiver are on different branch circuits.

If necessary, consult a Dell Technical Support representative or an experienced radio/television technician for additional suggestions.

Dell™ printers are designed, tested, and classified for their intended electromagnetic environment. These electromagnetic environment classifications generally refer to the following harmonized definitions:

- Class A is typically for business or industrial environments.
- Class B is typically for residential environments.

Information Technology Equipment (ITE), including devices, expansion cards, printers, input/output (I/O) devices, monitors, and so on, that are integrated into or connected to the printer should match the electromagnetic environment classification of the printer.

A Notice About Shielded Signal Cables: Use only shielded cables for connecting devices to any Dell device to reduce the possibility of interference with radio communications services. Using shielded cables ensures that you maintain the appropriate EMC classification for the intended environment. For parallel printers, a cable is available from Dell. If you prefer, you can order a cable from Dell on the World Wide Web at accessories.us.dell.com/sna/category.asp?category_id=4117.

Most Dell printers are classified for Class B environments. However, the inclusion of certain options can change the rating of some configurations to Class A. To determine the electromagnetic classification for your printer or device, see the following sections specific for each regulatory agency. Each section provides country-specific EMC/EMI or product safety information.

FCC Notices (U.S. Only)

Most Dell printers are classified by the Federal Communications Commission (FCC) as Class B digital devices. To determine which classification applies to your printer, examine all FCC registration labels located on the bottom, side, or back panel of your printer, on card-mounting brackets, and on the cards themselves. If any one of the labels carries a Class A rating, your entire printer is considered to be a Class A digital device. If *all* labels carry an FCC Class B rating as distinguished by either an FCC ID number or the FCC logo, (**FC**), your printer is considered to be a Class B digital device.

Once you have determined your printer's FCC classification, read the appropriate FCC notice. Note that FCC regulations provide that changes or modifications not expressly approved by Dell could void your authority to operate this equipment.

This device complies with Part 15 of the FCC Rules. Operation is subject to the following two conditions:

- This device may not cause harmful interference.
- This device must accept any interference received, including interference that may cause undesired operation.

Class A

This equipment has been tested and found to comply with the limits for a Class A digital device pursuant to Part 15 of the FCC Rules. These limits are designed to provide reasonable protection against harmful interference when the equipment is operated in a commercial environment. This equipment generates, uses, and can radiate radio frequency energy and, if not installed and used in accordance with the manufacturer's instruction manual, may cause harmful interference with radio communications. Operation of this equipment in a residential area is likely to cause harmful interference, in which case you will be required to correct the interference at your own expense.

Class B

This equipment has been tested and found to comply with the limits for a Class B digital device pursuant to Part 15 of the FCC Rules. These limits are designed to provide reasonable protection against harmful interference in a residential installation. This equipment generates, uses, and can radiate radio frequency energy and, if not installed and used in accordance with the manufacturer's instruction manual, may cause interference with radio communications. However, there is no guarantee that interference will not occur in a particular installation. If this equipment does cause harmful interference to radio or television reception, which can be determined by turning the equipment off and on, you are encouraged to try to correct the interference by one or more of the following measures:

- Reorient or relocate the receiving antenna.
- Increase the separation between the equipment and the receiver.
- Connect the equipment into an outlet on a circuit different from that to which the receiver is connected.
- Consult the dealer or an experienced radio/television technician for help.

FCC Identification Information

The following information is provided on the device or devices covered in this document in compliance with FCC regulations:

- Model number: Dell Laser Printer 1100
- Company name:

Dell Inc.
One Dell Way
Round Rock, Texas 78682 USA
512-338-4400

NOM Information (Mexico Only)

The following information is provided on the device(s) described in this document in compliance with the requirements of the official Mexican standards (NOM):

Exporter:	Dell Inc. One Dell Way Round Rock, TX 78682
Importer:	Dell Computer de México, S.A. de C.V. Paseo de la Reforma 2620 - 11° Piso Col. Lomas Altas 11950 México, D.F.
Ship to:	Dell Computer de México, S.A. de C.V. al Cuidado de Kuehne & Nagel de México S. de R.L. Avenida Soles No. 55 Col. Peñon de los Baños 15520 México, D.F.
Model number:	Dell Laser Printer 1100
Supply voltage:	110~127 VAC
Frequency:	50 Hz/60 Hz
Current Consumption:	4.0 Arms
Output voltage:	+5 VDC, +24 VDC,
Output current:	0.8 Arms (+5 VDC), 1.5 Arms (+24 VDC)

Export Regulations

Customer acknowledges that these Products, which may include technology and software, are subject to the customs and export control laws and regulations of the United States (“U.S.”) and may also be subject to the customs and export laws and regulations of the country in which the Products are manufactured and/or received. Customer agrees to abide by those laws and regulations. Further, under U.S. law, the Products may not be sold, leased or otherwise transferred to restricted end-users or to restricted countries. In addition, the Products may not be sold, leased or otherwise transferred to, or utilized by an end-user engaged in activities related to weapons of mass destruction, including without limitation, activities related to the design, development, production or use of nuclear weapons, materials, or facilities, missiles or the support of missile projects, and chemical or biological weapons.

Dell™ Software License Agreement

This is a legal agreement between you, the user, and Dell Products L.P. ("Dell"). This agreement covers all software that is distributed with the Dell product, for which there is no separate license agreement between you and the manufacturer or owner of the software (collectively the "Software"). This agreement is not for the sale of Software or any other intellectual property. All title and intellectual property rights in and to Software is owned by the manufacturer or owner of the Software. All rights not expressly granted under this agreement are reserved by the manufacturer or owner of the Software. By opening or breaking the seal on the Software packet(s), installing or downloading the Software, or using the Software that has been preloaded or is embedded in your product, you agree to be bound by the terms of this agreement. If you do not agree to these terms, promptly return all Software items (disks, written materials, and packaging) and delete any preloaded or embedded Software.

You may use one copy of the Software on only one computer at a time. If you have multiple licenses for the Software, you may use as many copies at any time as you have licenses.

"Use" means loading the Software in temporary memory or permanent storage on the computer. Installation on a network server solely for distribution to other computers is not "use" if (but only if) you have a separate license for each computer to which the Software is distributed. You must ensure that the number of persons using the Software installed on a network server does not exceed the number of licenses that you have. If the number of users of Software installed on a network server will exceed the number of licenses, you must purchase additional licenses until the number of licenses equals the number of users before allowing additional users to use the Software. If you are a commercial customer of Dell or a Dell affiliate, you hereby grant Dell, or an agent selected by Dell, the right to perform an audit of your use of the Software during normal business hours, you agree to cooperate with Dell in such audit, and you agree to provide Dell with all records reasonably related to your use of the Software. The audit will be limited to verification of your compliance with the terms of this agreement.

The Software is protected by United States copyright laws and international treaties. You may make one copy of the Software solely for backup or archival purposes or transfer it to a single hard disk provided you keep the original solely for backup or archival purposes. You may not rent or lease the Software or copy the written materials accompanying the Software, but you may transfer the Software and all accompanying materials on a permanent basis as part of a sale or transfer of the Dell product if you retain no copies and the recipient agrees to the terms hereof. Any transfer must include the most recent update and all prior versions. You may not reverse engineer, decompile or disassemble the Software. If the package accompanying your computer contains compact discs, 3.5" and/or 5.25" disks, you may use only the disks appropriate for your computer. You may not use the disks on another computer or network, or loan, rent, lease, or transfer them to another user except as permitted by this agreement.

Limited Warranty

Dell warrants that the Software disks will be free from defects in materials and workmanship under normal use for ninety (90) days from the date you receive them. This warranty is limited to you and is not transferable. Any implied warranties are limited to ninety (90) days from the date you receive the Software. Some jurisdictions do not allow limits on the duration of an implied warranty, so this limitation may not apply to you. The entire liability of Dell and its suppliers, and your exclusive remedy, shall be (a) return of the price paid for the Software or (b) replacement of any disk not meeting this warranty that is sent with a return authorization number to Dell, at your cost and risk. This limited warranty is void if any disk damage has resulted from accident, abuse, misapplication, or service or modification by someone other than Dell. Any replacement disk is warranted for the remaining original warranty period or thirty (30) days, whichever is longer.

Dell does NOT warrant that the functions of the Software will meet your requirements or that operation of the Software will be uninterrupted or error free. You assume responsibility for selecting the Software to achieve your intended results and for the use and results obtained from the Software.

DELL, ON BEHALF OF ITSELF AND ITS SUPPLIERS, DISCLAIMS ALL OTHER WARRANTIES, EXPRESS OR IMPLIED, INCLUDING, BUT NOT LIMITED TO, IMPLIED WARRANTIES OF MERCHANTABILITY AND FITNESS FOR A PARTICULAR PURPOSE, FOR THE SOFTWARE AND ALL ACCOMPANYING WRITTEN MATERIALS. This limited warranty gives you specific legal rights; you may have others, which vary from jurisdiction to jurisdiction.

IN NO EVENT SHALL DELL OR ITS SUPPLIERS BE LIABLE FOR ANY DAMAGES WHATSOEVER (INCLUDING, WITHOUT LIMITATION, DAMAGES FOR LOSS OF BUSINESS PROFITS, BUSINESS INTERRUPTION, LOSS OF BUSINESS INFORMATION, OR OTHER PECUNIARY LOSS) ARISING OUT OF USE OR INABILITY TO USE THE SOFTWARE, EVEN IF ADVISED OF THE POSSIBILITY OF SUCH DAMAGES. Because some jurisdictions do not allow an exclusion or limitation of liability for consequential or incidental damages, the above limitation may not apply to you.

U.S. Government Restricted Rights

The software and documentation are "commercial items" as that term is defined at 48 C.F.R. 2.101, consisting of "commercial computer software" and "commercial computer software documentation" as such terms are used in 48 C.F.R. 12.212. Consistent with 48 C.F.R. 12.212 and 48 C.F.R. 227.7202-1 through 227.7202-4, all U.S. Government end users acquire the software and documentation with only those rights set forth herein. Contractor/manufacturer is Dell Products, L.P., One Dell Way, Round Rock, Texas 78682.

General

This license is effective until terminated. It will terminate upon the conditions set forth above or if you fail to comply with any of its terms. Upon termination, you agree that the Software and accompanying materials, and all copies thereof, will be destroyed. This agreement is governed by the laws of the State of Texas. Each provision of this agreement is severable. If a provision is found to be unenforceable, this finding does not affect the enforceability of the remaining provisions, terms, or conditions of this agreement. This agreement is binding on successors and assigns. Dell agrees and you agree to waive, to the maximum extent permitted by law, any right to a jury trial with respect to the Software or this agreement. Because this waiver may not be effective in some jurisdictions, this waiver may not apply to you. You acknowledge that you have read this agreement, that you understand it, that you agree to be bound by its terms, and that this is the complete and exclusive statement of the agreement between you and Dell regarding the Software.

Index

B

Bezpečnostní informace, 11

C

canceling
 print, 25
card stock, loading, 24
cartridge
 ordering, 29
cleaning
 exterior, 33
 interior, 33
clearing
 paper jams, 35
components, iii
contacting, Dell, 44
control panel, 13

D

Dell
 contacting, 44

E

envelopes
 loading, 22
envelopes, print, 22
errors, solving, 40

G

Güvenlik bilgileri, 9

H

hardware setup, 13

I

Î, 7
informação de segurança, 10
Informacje o
 bezpieczeństwie, 12
installing, software, 15

J

jam, clearing, 35

L

labels, loading, 23
LEDs, 13
letterhead, loading, 24
loading
 paper
 in the manual feed
 mode, 21
 in the paper tray, 19

M

maintenance, 29
manual feed mode, using, 21

O

operator panel, 13
ordering supplies, 29

P

paper jams, clearing, 35
paper, loading, 19

R

replacing, toner cartridge, 30

S

safety information, 1
säkerhetsinformation, 6
setup, 13
Sikkerhedsoplysninger, 3
Sikkerhetsinformasjon, 5
software
 installing, 15
 uninstalling, 16
supplies, ordering, 29

support
 contacting Dell, 44

T

toner cartridge, replacing, 30
toner ordering, ii
transparencies, loading, 23
troubleshooting, 35
Turvallisuustiedot, 4

U

uninstalling, software, 16

V

Veiligheidsinformatie, 2

