

# TAXAN

## DATA PROJECTOR User's Manual

KG-PS232Xh/232X  
KG-PV131X/131S



### IMPORTANT

- DLP® (Digital Light Processing) and DLP® chip are registered trademarks of Texas Instruments Incorporated (U.S.A.).
- VGA and XGA are trademarks or registered trademarks of International Business Machines Corporation (U.S.A.).
- S-VGA is a registered trademark of Video Electronics Standards Association.
- Microsoft, Windows, and PowerPoint are registered trademarks of Microsoft Corporation (U.S.A. and other countries).
- Macintosh is a trademark of Apple Computer Inc. (U.S.A.).

Note that even in the absence of explanatory notes, serious attention is paid to the trademarks of the various companies and to the product trademarks.

## Important safety information

---

---

# DECLARATION OF CONFORMITY

---

---

This device complies with Part 15 of the FCC Rules. Operation is subject to the following two conditions. (1) This device may not cause harmful interference, and (2) this device must accept any interference received, including interference that may cause undesired operation.

<b>U.S. Responsible Party:</b>	<b>PLUS Vision Corp. of America</b>
<b>Address:</b>	<b>9610 SW Sunshine Court Suite 500 Beaverton, OR 97005</b>
<b>Tel. No.:</b>	<b>(503) 748 8700</b>

Type of Product: Projector  
Equipment Classification: Class B Peripheral  
Models: KG-PV131S, KG-PV131X, KG-PS232X, KG-PS232Xh



*We hereby declare that the equipment specified above  
conforms to the technical standards as specified in the FCC Rules.*

---

---

### Precautions

Thank you for your purchase of this TAXAN data projector.

Please read this User's Manual to the end so that you will be able to use this product properly.

After reading, keep this manual together with the Warranty in a safe place so that you may refer to it whenever you need it.

Please read this User's Manual should there be something that you need to know during operation of the projector or in case of an irregularity.

This User's Manual covers models **KG-PS232Xh/KG-PS232X**, and **KG-PV131X/KG-PV131S**.

The projection distance is the same in these models, but the screen resolution, auto focus function, and some other functions are different.

See the table below and the "Major Specifications" for details. See Pages E-90 to 93.

Model	Resolution (Full Function)	Auto Focus Function
<b>KG-PS232Xh</b>	1024 × 768 (XGA)	○
<b>KG-PS232X</b>	1024 × 768 (XGA)	○
<b>KG-PV131X</b>	1024 × 768 (XGA)	—
<b>KG-PV131S</b>	800 × 600 (S-VGA)	—

○: Function included, —: Function not included

## Important safety information



### CAUTION

TO PREVENT SHOCK, DO NOT OPEN THE CABINET. NO USER-SERVICEABLE PARTS INSIDE. REFER SERVICING TO QUALIFIED KAGA COMPONENTS SERVICE PERSONNEL.



This symbol warns the user that uninsulated voltage within the unit may have sufficient magnitude to cause electric shock. Therefore, it is dangerous to make any kind of contact with any part inside of this unit.



This symbol alerts the user that important literature concerning the operation and maintenance of this unit has been included. Therefore, it should be read carefully in order to avoid any problems.

The above cautions are given on the bottom of the product.

### WARNING

TO PREVENT FIRE OR SHOCK, DO NOT EXPOSE THIS UNIT TO RAIN OR MOISTURE. DO NOT USE THIS UNIT'S GROUNDED PLUG WITH AN EXTENSION CORD OR IN AN OUTLET UNLESS ALL THREE PRONGS CAN BE FULLY INSERTED. DO NOT OPEN THE CABINET. THERE ARE HIGH-VOLTAGE COMPONENTS INSIDE. ALL SERVICING MUST BE DONE BY QUALIFIED KAGA COMPONENTS SERVICE PERSONNEL.

### RF Interference

#### WARNING

This equipment has been tested and found to comply with the limits for a Class B digital device, pursuant to Part 15 of the FCC Rules. These limits are designed to provide reasonable protection against harmful interference in a residential installation. This equipment generates, uses and can radiate radio frequency energy and, if not installed and used in accordance with the instructions, may cause harmful interference to radio communications. However, there is no guarantee that interference will not occur in a particular installation. If this equipment does cause harmful interference to radio or television reception, which can be determined by turning the equipment off and on, the user is encouraged to try to correct the interference by one or more of the following measures:

- Reorientate or relocate the receiving antenna.
- Increase the separation between the equipment and receiver.
- Connect the equipment into an outlet on a circuit different from that to which the receiver is connected.
- Consult the dealer or an experienced radio/TV technician for help.

### DOC Compliance Notice

This Class B digital apparatus meets all requirements of the Canadian Interference-Causing Equipment Regulations.

**Hg: Lamp in This Product Contains Mercury. Dispose of Lamp According to Local, State or Federal Law.**

# Important safety information

## Important Safeguards

These safety instructions are to ensure the long life of the unit and to prevent fire and shock. Please read them carefully and heed all warnings.

### Installation

- For best results, use the unit in a darkened room.
- Place the unit on a flat, level surface in a dry area away from dust and moisture.
- Do not place the unit in direct sunlight, near heaters or heat radiating appliances.
- Exposure to direct sunlight, smoke or steam can harm internal components.
- Handle the unit carefully. Dropping or jarring can damage internal components.
- Do not place heavy objects on top of the unit.

### Power Supply

- The unit is designed to operate on a power supply of 100 - 240 V 50/60 Hz AC. Ensure that your power supply fits these requirements before attempting to use the unit.
- Handle the power cable carefully and avoid excessive bending. A damaged cord can cause electric shock or fire.
- Disconnect the power cable (main's lead) from the power outlet after using the unit.  
Before disconnecting the power cable, make sure that the indicator of the POWER/STANDBY button lights in orange (not flashing or in blue).

### Cleaning

- Disconnect the power cable (main's lead) from the unit.
- Clean the cabinet of the unit periodically with a damp cloth. If heavily soiled, use a mild detergent. Never use strong detergents or solvents such as alcohol or thinner.
- Use a blower or lens paper to clean the lens, and be careful not to scratch or mar the lens.
- Clean the ventilation slots and speaker grills on the unit periodically using a vacuum cleaner. If accumulated dust blocks the ventilation slots, the unit will overheat, which may cause the unit to malfunction.  
Use a soft brush attachment when using the vacuum cleaner. Do not use a hard attachment, such as a crevice tool, to prevent the damage to the unit.

### Lamp Replacement

- Be sure to replace the lamp when the LAMP indicator comes on. If you continue to use the lamp after 2000 hours of usage, the lamp will turn off.

### Fire and Shock Precautions

- Ensure that there is sufficient ventilation and that vents are unobstructed to prevent the buildup of heat inside the unit. Allow at least 10 cm (4 inches) of space between the unit and walls.
- Prevent foreign objects such as paper clips and bits of paper from falling into the unit. Do not attempt to retrieve any objects that fell into the unit. Do not insert any metal objects such as a wire or screwdriver into the unit. If something should fall into the unit, immediately disconnect the power cable from the unit and have the object removed by a qualified KAGA COMPONENTS service person.
- Do not place any liquids on top of the unit.

### Carrying around

When carrying the unit around, please use the soft case that comes with it and, to protect the lens from scratches, always shut the lens shutter. Also, do not subject the unit to strong mechanical shock.

### CAUTION – HOT!

The area around the exhaust vents is hot during and immediately after image projection.

To avoid burns, keep your hands away from this area.

Wait until the exhaust vents area cools off before touching it.

**Do not look into the lens while the unit is on. Serious damage to your eyes could result.**

# Ways of Viewing this Manual

There are five ways to search for information in this manual.

## 1 I just want to start using the projector

“The Procedure from Projection to Turning Off the Power”  
→ See Page E-21

This introduces the basic operations of this product.

## 2 I would like to know about convenient functions when projecting

“Helpful Hints” → See Page E-8

This introduces convenient functions of this product.

## 3 I would like to know about operations via the remote control and the projector control panel

“Finding Information with the Remote Control and the Projector Control Panel” → See Page E-10

This introduces operating information with the remote control and the projector control panel.

## 4 I would like to know about menu screen operation methods

“Finding Information from the Operations Screen” → See Page E-12

This introduces operating information from the illustrations of the menu screens.

## 5 I would like to look up operating information about this product using keywords

“Finding Information with Keywords” → See Page E-14

# Table of Contents

<b>Important safety information</b> .....	E-2
<b>Ways of Viewing this Manual</b> .....	E-5
<b>Table of Contents</b> .....	E-6
<b>Helpful Hints</b>	
<b>Convenient functions for the use of this product</b> .....	E-8
<b>Finding Information with the Remote Control and the Projector Control Panel</b>	
<b>Finding Information with the Remote Control</b> .....	E-10
<b>Finding Information with the Projector Control Panel</b> .....	E-11
<b>Finding Information from the Operations Screen</b> .....	E-12
Menu Screen Names and Functions .....	E-12
Menu Item List .....	E-13
<b>Finding Information with Keywords</b> .....	E-14
<b>Check before Use</b>	
<b>Check the Accessories</b> .....	E-15
<b>Names of the Projector Parts and their Functions</b> .....	E-17
<b>Names of the Remote Control Parts and their Functions</b> .....	E-19
<b>Preparing the Remote Control</b> .....	E-20
Installing the Batteries (and Battery Replacement) .....	E-20
<b>Basic Operation</b>	
<b>The Procedure from Projection to Turning Off the Power</b> .....	E-21
Basic Operation.....	E-21
<b>Placement</b> .....	E-25
Screen Size and Projection Distance .....	E-25
<b>Connecting Personal Computers and Video Equipment</b> .....	E-26
Connections with the Personal Computer.....	E-26
Connections with Typical Video Equipment .....	E-28
Connections with the AUDIO Jacks .....	E-30
Connections with the MONITOR OUT Connector .....	E-31
Connections with the RS-232C Connector.....	E-32
<b>Turning On the Power</b> .....	E-33
Turning On the Power for the First Time after Purchase .....	E-34
<b>Properly Adjusting the Projected Image to the Screen</b> .....	E-36
Adjusting the Projected Image: .....	E-36
<b>Turn off the power after projection is finished</b> .....	E-38
<b>Regular Operation</b> .....	E-39
Selection of Input Signal .....	E-39
Automatic Adjustment.....	E-39
Auto Focus (KG-PS232Xh/232X only) .....	E-40
Auto Keystone .....	E-40
Temporarily Blanking/Muting the Video/Audio .....	E-40
Pausing the Video.....	E-41
Projection Mode Selection .....	E-41
Eco Mode (KG-PS232Xh/232X only) .....	E-42
Manual Adjustment of Focus (KG-PS232Xh/232X only) .....	E-42
Manual Adjustment of Keystone .....	E-43
Volume.....	E-43
Enlargement of the Video and Image Movement.....	E-44
<b>Using the Menu</b>	
<b>Menu Operation Method</b> .....	E-46
Menu Screen Names and Functions.....	E-46
Names and Functions of the Remote Control Buttons and Projector Buttons .....	E-46
Using Menu Operations .....	E-47
<b>List of Items Allowing Adjustment or Setting of Each Input Signal</b> .....	E-49
<b>Simple Menu / Source</b> .....	E-51
Auto Detect.....	E-51
Manual selection.....	E-51

# Table of Contents

<b>Simple Menu / Settings</b> .....	<b>E-52</b>
Projection Mode .....	E-52
Auto Focus (KG-PS232Xh/232X only) .....	E-53
Auto Keystone .....	E-53
Keystone.....	E-54
Auto Power Off .....	E-55
Eco Mode (KG-PS232Xh/232X only) .....	E-56
Status Display .....	E-56
<b>Simple Menu / Tools</b> .....	<b>E-57</b>
Blank/Mute.....	E-57
Still Image .....	E-57
Zoom.....	E-58
Timer Display .....	E-60
Volume .....	E-61
Select Language.....	E-62
<b>Advanced Menu / Image</b> .....	<b>E-63</b>
Brightness / Contrast / Sharpness .....	E-63
Frequency Compensation.....	E-64
Phase Control .....	E-65
Definition.....	E-65
<b>Advanced Menu / View</b> .....	<b>E-66</b>
Select Aspect Ratio .....	E-66
Horizontal Position / Vertical Position .....	E-68
Vertical Flip / Horizontal Flip .....	E-68
<b>Advanced Menu / Color</b> .....	<b>E-69</b>
Custom Mode .....	E-69
Gamma Correction .....	E-69
Color Temperature .....	E-70
White Level .....	E-70
White Balance .....	E-71
Color Space .....	E-72
Chroma.....	E-72
Hue .....	E-73
<b>Advanced Menu / Input</b> .....	<b>E-74</b>
<b>Advanced Menu / Admin</b> .....	<b>E-75</b>
Set Password.....	E-75
Version .....	E-78
Lamp Timer.....	E-79
Lamp Timer Reset .....	E-80
Initialize .....	E-81
Startup Screen .....	E-81
Background Color .....	E-82
<b>Troubleshooting</b> .....	<b>E-83</b>
When an indicator is lit or flashing .....	E-83
At a time such as this... ..	E-84
<b>Maintenance</b> .....	<b>E-86</b>
Cleaning .....	E-86
Replacing the Lamp Cartridge .....	E-87
<b>Major Specifications</b> .....	<b>E-90</b>
Specifications List.....	E-90
Table of Supported Frequency .....	E-94
Cabinet Dimensions.....	E-95

## Convenient functions for the use of this product

### I would like to use the projector in a simple manner.

This product is equipped with an auto focus function and an auto keystone correction function. (Only the **KG-PS232Xh/232X** have the auto focus function.) When shipped from the factory, both of these functions are ON. When using this product, just press the POWER/STANDBY button and set the image size with the zoom ring to allow the image to be projected simply. See "Basic Operation" for details. See Page E-21.

#### Technical Point

##### What is the automatic keystone correction function?

When the projector is tilted up or down when projecting, the picture will appear distorted.

There are two types of keystone distortion, in the horizontal or vertical direction. This projector has a function that manually or automatically corrects the distortion in the vertical direction.

See "Auto Keystone," and "Keystone" for details. See Pages E-53 and 54.

### I would like to project a clear image in conjunction with the projection location. (Example: I would like to project onto a blackboard, etc.)

A projection mode to suit the purpose can be selected with **Projection Mode** under **Simple Menu**. For example, by selecting the **Blackboard** mode a color adjustment that suits blackboards will be made automatically, allowing a clear image to be projected without making detailed settings. Other modes include **Graphics** and **Presentation** modes.

See "Projection Mode Selection" for information about operation from the remote control. See Page E-41.

See "Projection Mode" for information about operation from the menu. See Page E-52.

#### Technical Point

##### What is the projection mode?

This projector is already equipped with projection modes that suit the application. This permits an immediate color adjustment to suit the purpose without performing detailed adjustments such as **Gamma Correction**, **Color Temperature**, or **White Level**.

### I would like to stop the projection temporarily.

The projection can be stopped temporarily during a presentation or class. By using **Still Image** (FREEZE), or **Blank/Mute** (BLANK) the projection can be paused, or the video can be made blank temporarily.

See "Temporarily Blanking/Muting the Video/Audio," or "Pausing the Video" for information about operation from the remote control. See Pages E-40 and 41.

See "Blank/Mute" or "Still Image" for information about operation from the menu. See Page E-57.

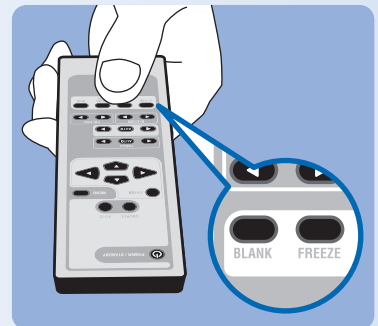



# Convenient functions for the use of this product

### I would like the lamp to have a longer life.

The life of the lamp can be maintained longer by using the Eco Mode to limit the power consumption of the projector. **KG-PS232Xh/232X only**  
See "Eco Mode" for information about operation from the remote control. See Page E-42.  
See "Eco Mode" for information about operation from the menu. See Page E-56.



### I would like to put away the projector right after using it.

The projector is equipped with a Quick-off function. After turning off the power, the fan will continue to turn to cool the lamp even when the power cable has been disconnected.  
See "The Procedure from Projection to Turning Off the Power" for details about the Quick-off function. See Page E-24.

#### Technical Point

##### What is the Quick-off function?

The projector is equipped with a Quick-off function. Even when the power cable is unplugged soon after turning off the power, the internal power supply will power the rotation of the cooling fan and cool the lamp allowing immediate removal.

### Theft and mischief are concerns.

This projector is equipped with security lock functions that allow it to be used more safely including a theft-prevention lock compatible with the Kensington MicroSaver® security system, and a password setting  
See "Names of the Projector Parts and their Functions" for details about the theft-prevention lock. See Page E-18.  
See "Set Password" for information about setting the password. See Page E-75.

#### Technical Point

##### What is a password setting?

This projector is equipped with a function that can restrict the start-up of the projector by setting a password to avoid mischief and unauthorized use.

When a password has been set, upon starting the projector a password entry screen will be displayed. Use of the projector will not be possible unless the password is entered.

## Finding Information with the Remote Control

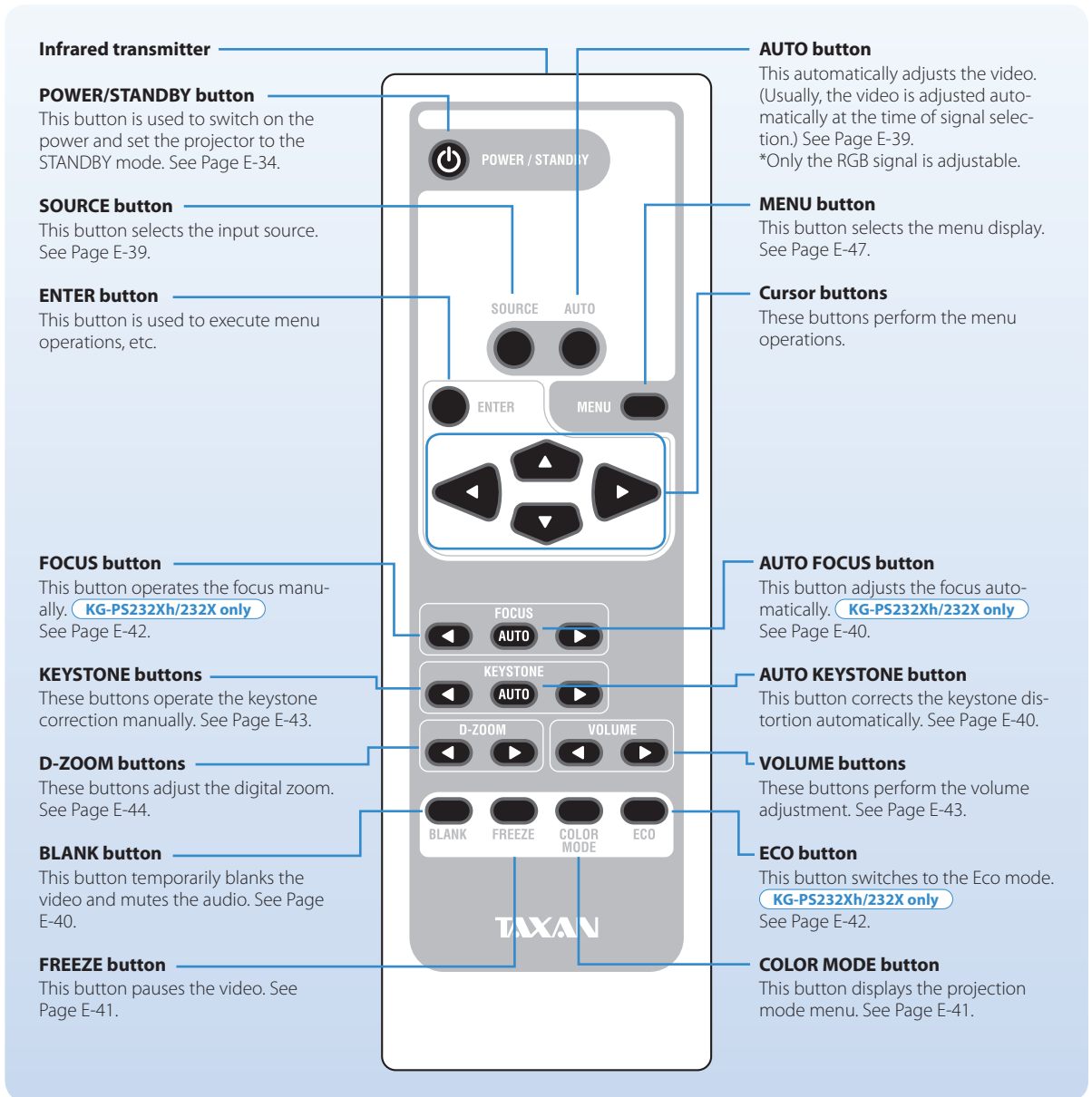

### Technical Point

#### What is BLANK?

It is a function that temporarily makes the screen go blank during video projection. This is convenient when you would like to temporarily blank the video when projecting to a white board, etc.

See "Temporarily Blanking/Muting the Video/Audio" for details. See Page E-40.

#### What is FREEZE?

It is a function that temporarily stops the projected video. This is a convenient function that allows you to temporarily stop the video and look for a document should you wish to find another document when projecting a document with the personal computer.

See "Pausing the Video" for details. See Page E-41.

#### What is COLOR MODE?

It is a function that automatically adjusts optimum color tone in conjunction with the projection circumstances. For example, when projecting to a blackboard, selecting the **Blackboard** mode will automatically set the optimum color adjustment to a blackboard.

See "Projection Mode Selection" for details. See Page E-41.

## Finding Information with the Projector Control Panel

### HEAT indicator

This is an indicator that indicates faults related to the temperature of the projector. See Page E-83.

### POWER/STANDBY button

This button is used to switch on the power and set the projector to the STANDBY mode. See Page E-34.

The power supply symbol  of the POWER/STANDBY button serves as an indicator that indicates the on/off status of the Eco mode, the temperature, and lamp faults. Eco Mode: See Pages E-42 and E-56. Indications of the indicator: See Page E-83.

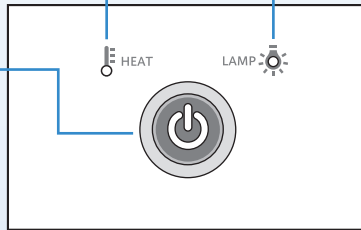

### LAMP indicator

This is an indicator that indicates faults related to the lamp. See Page E-83.

### Cursor buttons

These buttons perform the menu operations. (They are allocated to other functions when the menu screen is not being displayed.)

### MENU button

This button selects the menu display. See Page E-47.

### SOURCE button

This button displays the input source screen. See Page E-39.

### ENTER button

This button is used to execute menu operations, etc.

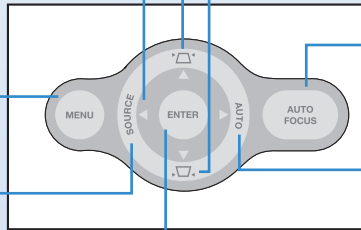

### KEystone buttons

These buttons operate the keystone correction manually. See Page E-43.

### AUTO FOCUS button

This button adjusts the focus automatically. **KG-PS232Xh/232X only**  
See Page E-40.

### AUTO button

This automatically adjusts the video. (Usually, the video is adjusted automatically at the time of signal selection.) See Page E-39.  
\* Only the RGB signal is adjustable.

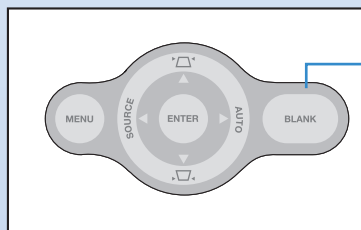

### BLANK button

This button temporarily blanks the video and mutes the audio. **KG-PV131X/131S only**  
See Page E-40.

### Technical Point

#### What is the menu display?

The menus of this projector include the two types of **Simple Menu** and **Advanced Menu**. **Simple Menu** includes a collection of frequently used functions. Included are On/Off switching of **Auto Keystone** and **Auto Focus**, **Projection Mode** and other items. On the contrary, the **Advanced Menu** includes infrequently used settings such as fine adjustments of the image and **Set Password**, etc. See "Using the Menu" for details. See Page E-46.

#### What is Keystone Distortion?

Keystone distortion is distortion of the projected image that occurs when the projector is tilted vertically or horizontally with respect to the screen. There are two types of keystone distortion, in the horizontal direction when the projector is slanted to the left or right, and in the vertical direction when the projector is tilted up or down. This projector can manually or automatically correct the distortion in the vertical direction. See "Auto Keystone", and "Keystone" for details. See Pages E-53 and 54.

## Finding Information from the Operations Screen

This section describes menu viewing and operation. Please see the various explanatory pages about menu functions and adjustment/setting methods. To use the remote control, direct it towards the remote control infrared sensor of the projector and operate it.

### Menu Screen Names and Functions

This projector has two types of menu, a **Simple Menu** that enables operation of basic functions, and an **Advanced Menu** that enables detailed settings such as image settings, etc. Since the operation method is the same for both types, the **Simple Menu** will be used here to describe the names and functions of the menu screen.

With respect to the Simple and Advanced screens, **Simple Menu** has a light gray background color. Selecting **Show Advanced** will change the display to the **Advanced Menu**.

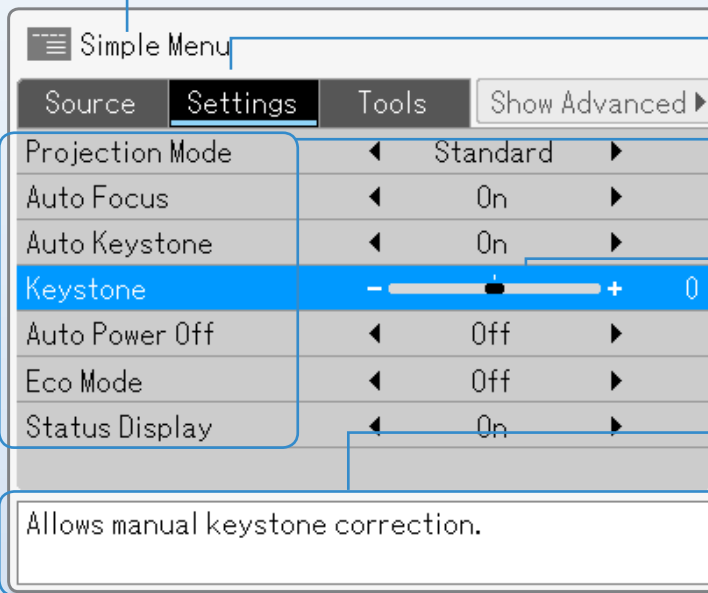

**Menu Name**

This is the title of the menu. The color of the selected menu will change.

**Item Name**

This is the name of the adjustment or setting. The (blue) cursor will move to the selected item.

**Adjustment Bar and Settings Contents**

The increases and decreases in bar length express the adjustment condition. The set contents are displayed in characters.

**Help**

A Help explanation related to the selected menu/item is displayed.

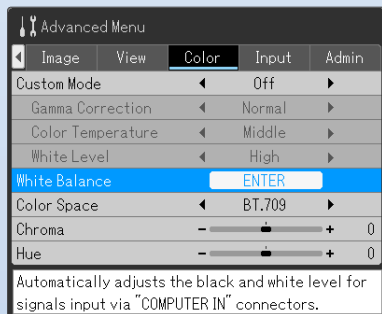

**Advanced Menu**

In the **Advanced Menu** the menu background color changes from light gray to deep gray.

## Finding Information from the Operations Screen

### Menu Item List

#### Simple Menu

Menu Name	Item Name	Page
Source	Auto Detect	E-51
	Manual selection	Computer1 E-51
		Computer2 E-51
		Video E-51
		S-Video E-51
Settings	Projection Mode	E-52
	Auto Focus	E-53
	Auto Keystone	E-53
	Keystone	E-54
	Auto Power Off	E-55
	Eco Mode	E-56
	Status Display	E-56
Tools	Blank/Mute	E-57
	Still Image	E-57
	Zoom	E-58
	Timer Display	E-60
	Volume	E-61
	Select language	E-62

#### Advanced Menu

Menu Name	Item Name	Page
Image	Brightness	E-63
	Contrast	E-63
	Sharpness	E-63
	Frequency Compensation	E-64
	Phase Control	E-65
	Definition	E-65
	View	Select Aspect Ratio E-66
	Horizontal Position	E-68
	Vertical Position	E-68
	Vertical Flip	E-68
	Horizontal Flip	E-68
Color	Custom Mode	E-69
	Gamma Correction	E-69
	Color Temperature	E-70
	White Level	E-70
	White Balance	E-71
	Color Space	E-72
	Chroma	E-72
	Hue	E-73
Input	Computer1	E-74
	Computer2	E-74
	Video	E-74
	S-Video	E-74
Admin	Set Password	E-75
	Version	E-78
	Lamp Timer	E-79
	Lamp Timer Reset	E-80
	Initialize	E-81
	Startup Screen	E-81
	Background Color	E-82

## Finding Information with Keywords

Keyword	Page
<b>Advanced Menu</b>	<b>E-50</b>
Aspect Ratio	E-66
AUTO	E-39
AUTO FOCUS	E-40
Auto Focus function	E-40, 53
AUTO KEYSTONE	E-40
Auto Keystone (Auto keystone correction)	E-40, 53
Auto Power Off	E-55
Background Color	E-82
BLANK	E-40
Blanking of the video	E-41, 57
Blanking/Muting of the video/audio	E-40, 57
Blurred Screen	E-37
Ceiling suspension setting	E-68
Chroma	E-72
COLOR MODE	E-41
Color Space	E-72
Color Temperature	E-70
<b>Computer 1/2</b>	<b>E-51, 74</b>
Contrast	E-63
Digital Zoom	E-44, 58
D-ZOOM	E-44
ECO	E-42
Eco Mode	E-42, 56
Flashing indicator	E-83
Focus	E-37, 42
FOCUS	E-42
FREEZE	E-41
Frequency	E-64, 94
Gamma	E-69
HEAT	E-83
Hue	E-73

Keyword	Page
Initial Setting	E-34
Initialize	E-81
Input source	E-39, 51
KEYSTONE	E-43
Keystone (Keystone correction)	E-43, 54
Keystone distortion	E-40, 43, 53, 54
LAMP	E-83
Lamp replacement	E-87
Language	E-62
MENU	E-47
No signal	E-27
Notebook computer external output signal	E-27
Phase	E-65
POWER/STANDBY	E-10, 11, 22
Projection Mode	E-41, 52
Quick-off function	E-24
Rear Projection	E-68
RS-232C connector	E-32
Sharpness	E-63
<b>Simple Menu</b>	<b>E-49</b>
<b>Source</b>	<b>E-39, 51</b>
SOURCE	E-39
Standby	E-33
Startup Screen	E-81
Status Display	E-56
Timer	E-60
<b>Video/S-Video</b>	<b>E-51, 74</b>
Volume	E-43, 61
VOLUME	E-43
White Balance	E-71
White Level	E-70

## Check before Use

# Check the Accessories

Remove the projector and the accessories from the box and check that the following items are included.

\*The supplied power cable is a dedicated product for this projector. Never use it with another product.

### Remote control (including two AA batteries) [1]

This remote control is used for projector operation. See Page E-19.

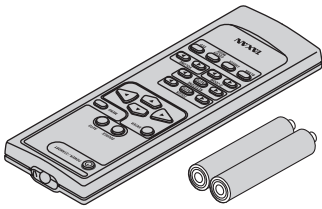

### RGB signal cable (Mini D-Sub 15-pin, 2 m / 6.6 feet) [1]

This is used for making connections with a personal computer. See "Connections with a Personal Computer" for connection information. See Page E-26.

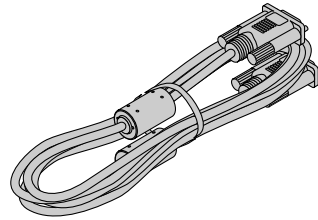

### Power cable (1.8 m / 5.9 feet) [1]

This power cable supplies power to the unit. See "Turning On the Power" for connection information. See Page E-33.

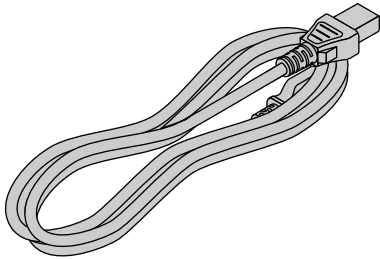

### Ferrite core [3]

These ferrite cores are attached to the two power cables and either one of the video cable or S-video cable. See "Attaching the Ferrite Core" for details. See Pages E-28 and 33.

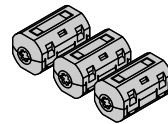

### Technical Point

#### What is a ferrite core?

These are accessories that are used to reduce the radiated noise from the interface cables of digital equipment and other devices. When a high frequency current that is the source of noise flows in a cable, it will generate a magnetic field and noise will be emitted. The ferrite core absorbs this and converts it to heat which is radiated. Attaching a ferrite core will reduce the deterioration of the picture.

### "WARNING"

Handling the cables supplied with this product, will expose you to lead, a chemical known to the State of California to cause birth defects or other reproductive harm.  
Wash hands after handling.

## Check before Use

# Check the Accessories

### Soft Case [1]

This case will hold the projector, the accessories, and the user's manual.

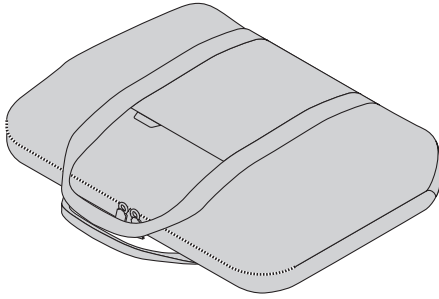

### Item Insertion

Close the lens shutter of the projector and place the projector in the case with the lens facing upward. Place the accessories in the storage pocket.

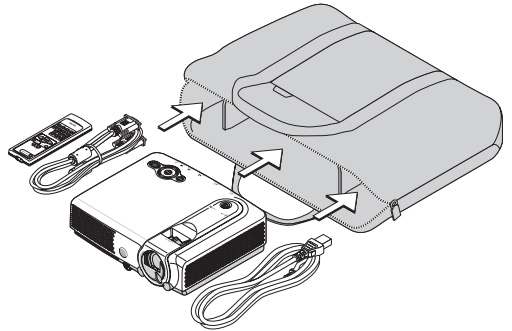

### User's manual (CD-ROM edition) [1]

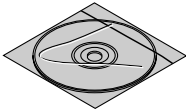

### Startup Guide [1]

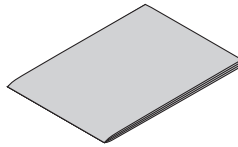

### Safety and Support Service Guide [1]

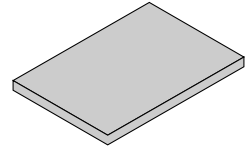

### Security Sheet [1]

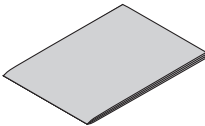

### Security Label [1]

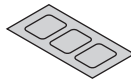



## Names of the Projector Parts and their Functions

KG-PS232Xh/232X

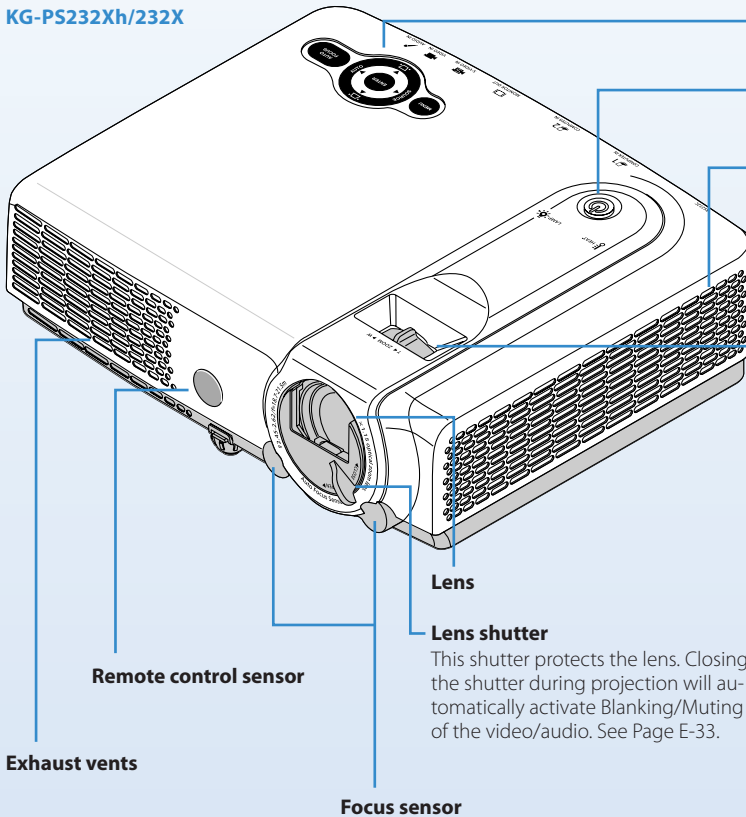

**Projector control panel**  
See Page E-11

**POWER/STANDBY button**  
See Page E-33

**Ventilation slots**

KG-PV131X/131S

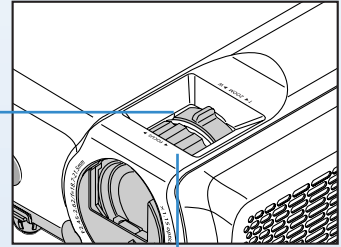

**Focus ring**  
Adjusts the focus of the screen picture. See Page E-37.

**Zoom ring**  
Adjusts the size of the screen picture. See Page E-36

**Front adjuster**  
Adjusts the projection angle. See Page E-36.

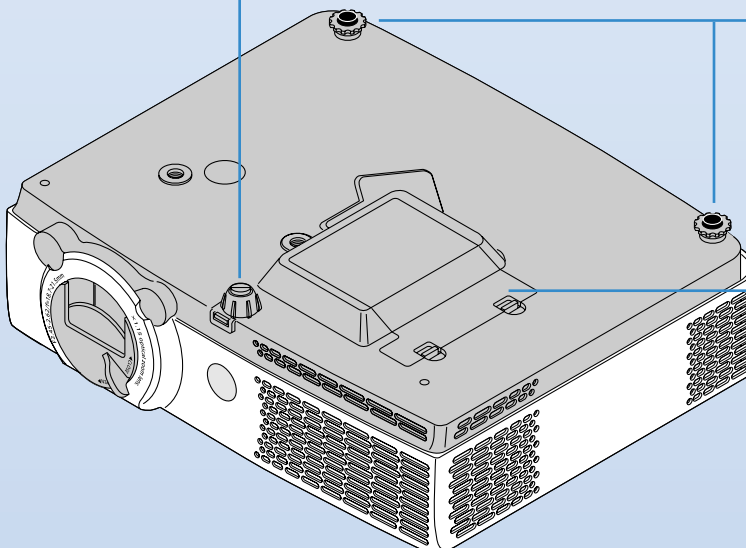

**Rear adjusters**  
Adjust the projection angle. See Page E-36.

**Lamp cover**  
See "Replacing the Lamp Cartridge" for information about how to replace the lamp. See Page E-87.

## Names of the Projector Parts and their Functions

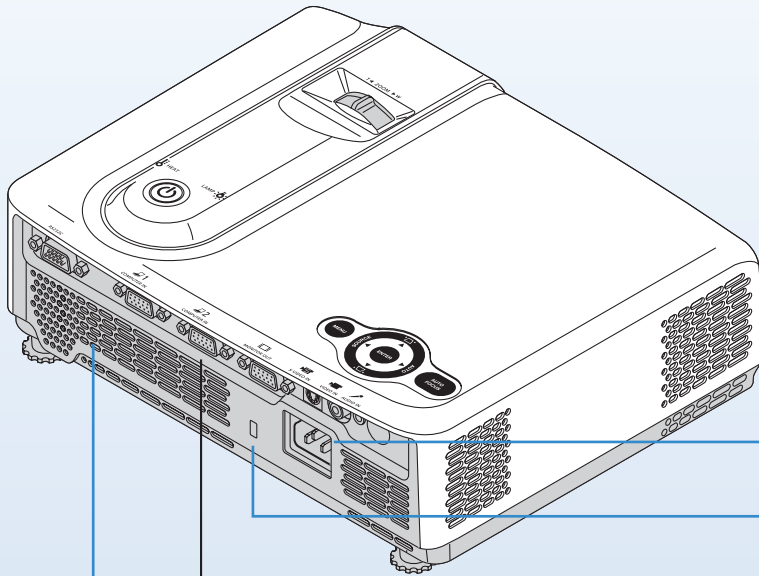

**Ventilation slots**

**AC IN connector**

See Page E-33

**Built-in Security Slot**

This is compatible with the Micro-Saver® security system manufactured by Kensington Computer Products Group. (See below)

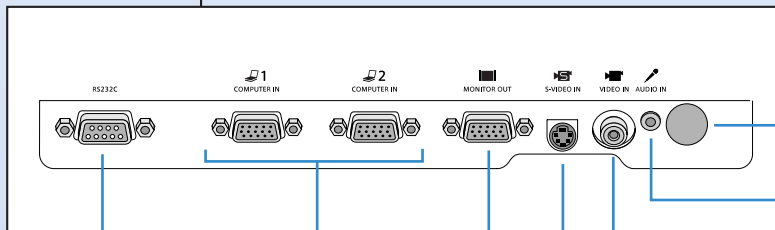

**Remote control sensor**

**AUDIO IN connector**

See Page E-30

**VIDEO IN connector**

See Page E-28

**S-VIDEO IN connector**

See Page E-28

**RS-232C connector**

This connector is used for projector control. See Page E-32

**COMPUTER IN connector**

See Page E-26

**MONITOR OUT connector**

This connector is used for video output. See Page E-31



### **Built-in Security Slot**

This security slot supports the MicroSaver Security System manufactured by Kensington Microware Inc.

# Names of the Remote Control Parts and their Functions

Two types of remote control are available for this product.

Here, the description will be based on the remote control for model **KG-PS232Xh/232X**.

\* The remote control for model **KG-PV131X/131S** does not include some of the buttons. See description below for details.

## ! Precautions

- Do not drop the remote control or handle it inappropriately.
- Do not expose the remote control to water or other liquids. Should the remote control become wet, wipe it dry immediately.
- Try to avoid use in hot and/or humid locations.
- Please keep batteries out of the reach of children. If a battery is swallowed, promptly obtain the medical care of a doctor.
- Remove the battery from the remote control when it is not going to be used for a long period.
- Some operations (such as menu operations) are available only through the use of the remote control and attention should be given to its careful handling.

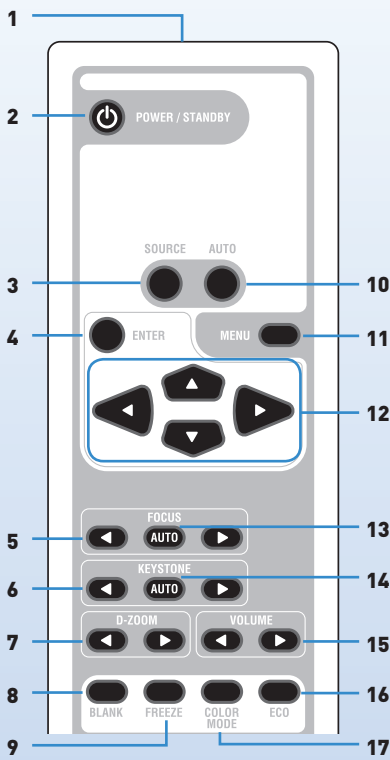

### 1. Infrared transmitter

### 2. POWER / STANDBY button

This button is used to switch on the power and set the projector to the STANDBY mode. See Page E-34.

### 3. SOURCE button

This button selects the input source. See Page E-39.

### 4. ENTER button

This button is used to execute menu operations, etc.

### 5. FOCUS button

This button operates the focus manually. **KG-PS232Xh/232X only**  
See Page E-42.

### 6. KEYSTONE buttons

These buttons operate the keystone correction manually. See Page E-43.

### 7. D-ZOOM buttons

These buttons adjust the digital zoom. See Page E-44.

### 8. BLANK button

This button temporarily blanks the video and mutes the audio. See Page E-40.

### 9. FREEZE button

This button pauses the video. See Page E-41.

### 10. AUTO button

This automatically adjusts the video. (Usually, the video is adjusted automatically at the time of signal selection.) See Page E-39.

\* Only the RGB signal is adjustable.

### 11. MENU button

This button selects the menu display. See Page E-47.

### 12. Cursor buttons

These buttons perform the menu operations.

### 13. AUTO FOCUS button

This button adjusts the focus automatically. **KG-PS232Xh/232X only**  
See Page E-40.

### 14. AUTO KEYSTONE button

This button corrects the keystone distortion automatically. See Page E-40.

### 15. VOLUME buttons

These buttons perform the volume adjustment. See Page E-43.

### 16. ECO button

This button switches to the Eco mode. **KG-PS232Xh/232X only**  
See Page E-42.

### 17. COLOR MODE button

This button displays the projection mode menu. See Page E-41.

## 📖 Technical Point

### What is BLANK?

It is a function that temporarily makes the screen go blank during video projection. This is convenient when you would like to temporarily blank the video when projecting to a white board, etc.

See "Temporarily Blanking/Muting the Video/Audio" for details. See Page E-40.

### What is FREEZE?

It is a function that temporarily stops the projected video. This is a convenient function that allows you to temporarily stop the video and look for a document should you wish to find another document when projecting a document with the personal computer.

See "Pausing the Video" for details. See Page E-41.

### What is COLOR MODE?

It is a function that automatically adjusts optimum color tone in conjunction with the projection circumstances. For example, when projecting to a blackboard, selecting the **Blackboard** mode will automatically set the optimum color adjustment to a blackboard.

See "Projection Mode Selection" for details. See Page E-41.

## Preparing the Remote Control

### Installing the Batteries (and Battery Replacement)

The projector and the batteries are packaged separately. Insert the batteries in the remote control before use. When it is time to replace the batteries, do so using the same procedure.

1. Open the cover of the battery case located on the back of the remote control.

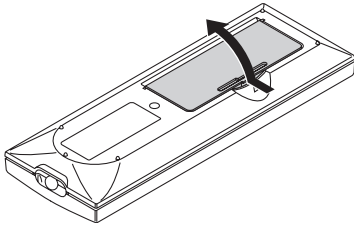

2. Insert the batteries so that + and – ends match the markings inside the case.

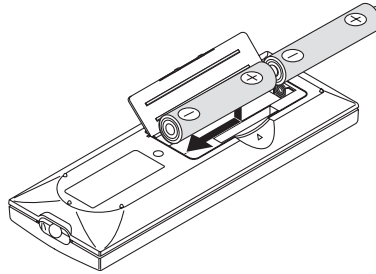

3. Close the cover of the battery case.

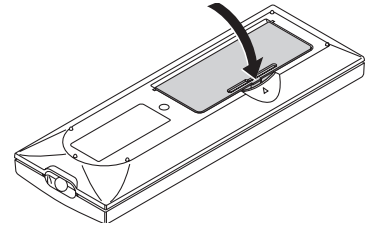

#### ! Precautions

- Use the same type of replacement batteries as the supplied AA batteries. There is danger of explosion if different battery types are used.
- Dispose of used batteries according to the local regulations.

#### ! Note

- Exposure of the main unit's remote control sensor or the remote control infrared transmitter to bright light or the obstruction of the signal by an obstacle located in the pathway may prevent operation. To prevent operational difficulties with the sensor when the projector is installed suspended from the ceiling, install the projector 1.5 m (4.9 feet) or further from fluorescent lighting.
- The remote control will not function properly when the batteries are weak.

# The Procedure from Projection to Turning Off the Power

## Basic Operation

This section provides a simple description of the method of operation from projector setup, to video projection, and finishing up. For the detailed operational methods of the various operations, please see the respective pages with the description.

### 1 Placement

Determine the setup locations of the screen and the projector and set up the items.

See “Screen Size and Projection Distance” for information about distance and placement considerations at the time of setup. See Page E-25.

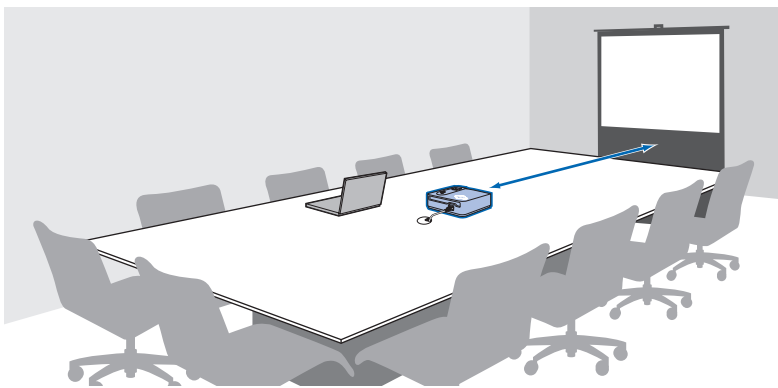

### 2 Connecting Personal Computers and Video Equipment

Connect the projector and your equipment.

- To make connection with the RGB connector of a personal computer, see Connections with Personal Computer on Page E-26.
- To make connection with the video connector (RCA jack) of video equipment, or an S-video connector, see “Connections with Typical Video Equipment” on Page E-28.
- To make connection with the YCbCr connector, or YPbPr connector of video equipment, see “Using YCbCr Connectors or YPbPr Connectors” on Page E-29.

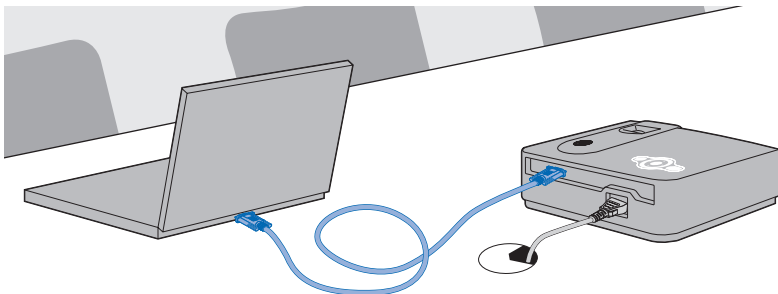

#### Note

- In consideration of quality, perfection is expected, but very rarely black or bright dots may exist among the pixels of DLP® type projectors. Thank you for your understanding.
- Please purchase a screen separately.

#### Technical Point

##### What is an RGB connector?

This is a connector used for transferring video signals to a monitor or other equipment. The three colors R (red), G (green), and B (blue) are separated and transferred as an analog signal with this system. The display of a personal computer is expressed by the RGB color space, and synthesizing the three colors permits all colors to be reproduced. These connectors mainly use a standard called mini D-Sub 15-pin that describes their form, and control signals used for signal synchronization, as well as other signals, are transferred at the same time as the RGB color signal.

##### What is a Video Connector, an S-connector, a YCbCr Connector, and a YPbPr Connector?

Several types of connectors are used as video connectors including composite video connectors, separate video connectors, and component video connectors.

Composite video connectors are usually called pin jacks or RCA jacks, and they are mainly included on video decks, document cameras, etc.

Separate video connectors are most typically called S-video, and because they take the form of mini DIN 4-pin connectors, mini DIN 4-pin may also be used to describe S-video.

Component video connectors are called color-difference input connectors. The usual NTSC (480i) signal connector that transfers the C color signal which is divided into the B-Y color-difference signal Cb (Pb), and the R-Y color-difference signal Cr (Pr) is described as Y/Cb/Cr. Connectors that can be used for video formats above NTSC may be described as Y/Pb/Pr.

#### Note

- A commercially-available component cable is required to make connection with equipment having YCbCr connectors such as DVD players, etc.
- A commercially-available component cable is required to make connection with equipment having YPbPr connectors such as high definition video equipment, etc.

## The Procedure from Projection to Turning Off the Power

### 3 Turn On the Power

Press the POWER/STANDBY button of the remote control or the projector and turn on the power.

The indicator of the POWER/STANDBY button will change from the orange color of the standby mode to (flashing) blue. See “Turning On the Power” for details about when the power is turned on. See Page E-33.

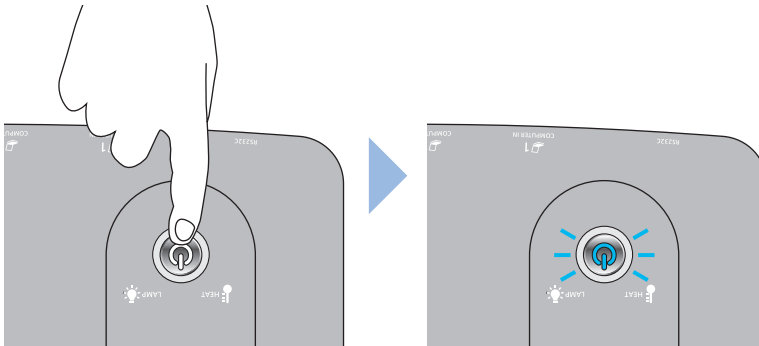

### 4 The Video Is Projected

**Language Settings** and other initial settings will be displayed only when the power is turned on for the first time after purchase. See “Turning On the Power for the First Time after Purchase” on Page E-34.

The factory default setting is for **Automatic Detection** be **On**. This will automatically project the video when an input signal is detected.

- When attempting to project video from a notebook computer, and video is not projected, see “To Output the External Output Signal of a Notebook Computer” on Page E-27.

#### Technical Point

The projector is equipped with a Quick-start function. The Quick-start function is a function that projects the video a short time after pressing the POWER/STANDBY button. The video will be projected a little over ten seconds after pressing the POWER/STANDBY button.

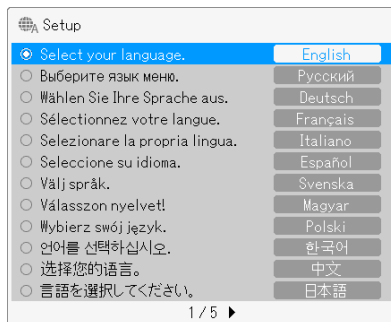

## The Procedure from Projection to Turning Off the Power

### 5 Properly Adjusting the Projected Image to the Screen

- Model **KG-PS232Xh/232X** is equipped with an Auto Focus function. This function automatically adjusts the focus when the size of the projected image is adjusted with the zoom ring.
- Since model **KG-PV131X/131S** does not have an Auto Focus function, please adjust the size of the projected image with the zoom ring, and adjust the focus with the focus ring. See "Adjusting the Focus" on Page E-37 for details.

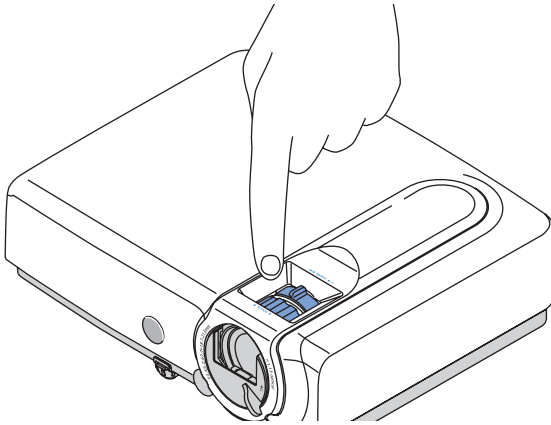

#### Technical Point

##### What is the Auto Focus function?

Model **KG-PS232Xh/232X** is equipped with an Auto Focus function. The Auto Focus function is a function that measures the distance to the screen and performs the focus adjustment automatically. Auto Focus uses the infrared sensor at the front of the projector to determine the screen position and adjust the focus.

See "Auto Focus" for information about the setting method. See Page E-53.

### 6 Adjusting Images and Video

Adjust the video to the optimal condition as required.

- **AUTO** button: Automatically adjusts the image of the RGB signal. "Automatic Adjustment" See Page E-39.
- **Projection Mode**: Can select a projection mode to suit the purpose. "Projection Mode selection" See Page E-41.
- **Advanced Menu**: Allows more detailed video settings to be made such as **Image**, and **Color**. "Advanced Menu" See Page E-63.

#### Technical Point

##### What is the projection mode?

It is a function that automatically adjusts optimum color tone in conjunction with the projection circumstances.

For example, when projecting to a blackboard, selecting the **Blackboard** mode will automatically set the optimum color adjustment to a blackboard.

Continued on next page →

## The Procedure from Projection to Turning Off the Power

### 7 Turn Off the Power after Projection is Finished

After projection is finished, press the POWER/STANDBY button to turn off the power.

This message will be displayed: Turning power off – Press "POWER/STANDBY" to proceed. (Press "MENU" to cancel.)

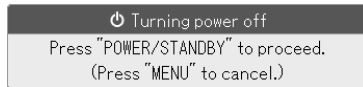

A press of the POWER/STANDBY button cause the screen to go blank and will enter the projector into the power off operation. When the Quick-off function is not being used, check that the POWER/STANDBY button indicator is lit in orange in the standby mode and then disconnect the power cable. When the power cable is disconnected, the indicator of the POWER/STANDBY button will go off.

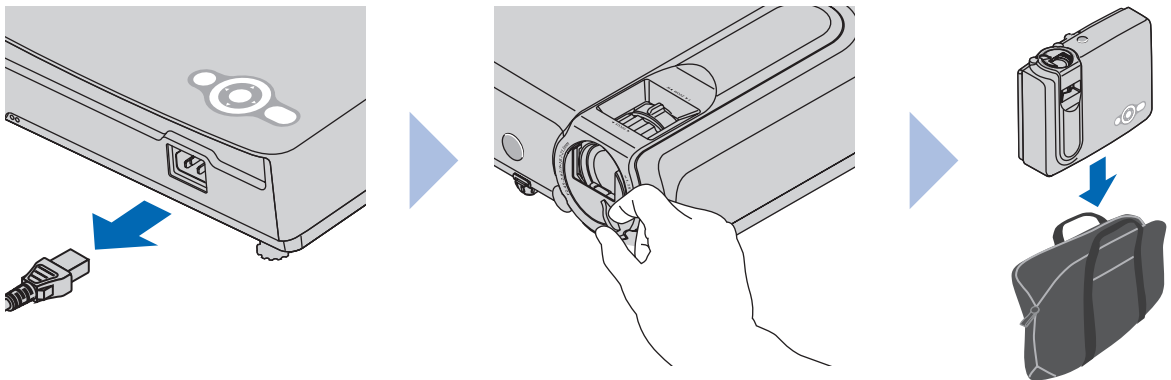

#### Technical Point

##### What is the Quick-off function?

The projector is equipped with a Quick-off function. Even when the power cable is unplugged soon after turning off the power, the internal power supply will power the rotation of the cooling fan and cool the lamp allowing immediate removal.

#### Note

- After cooling the projector with the power cable connected, relighting of the lamp might become difficult.
- Do not place the projector in a bag or other enclosure while the cooling fan is turning.



# Placement

- Use this information as a guide to find out about what the screen size will be for the projected video when placing the projector.
- The projection distance over which focusing is adjustable is 1.20 m (3.9 feet) to 11.79 m (38.65 feet) from the projector lens surface. The projector should be placed within this range.
- It will be necessary to change the projection method when the projector is installed suspended from the ceiling. See “Vertical Flip / Horizontal Flip”. See Page E-68.

## Screen Size and Projection Distance

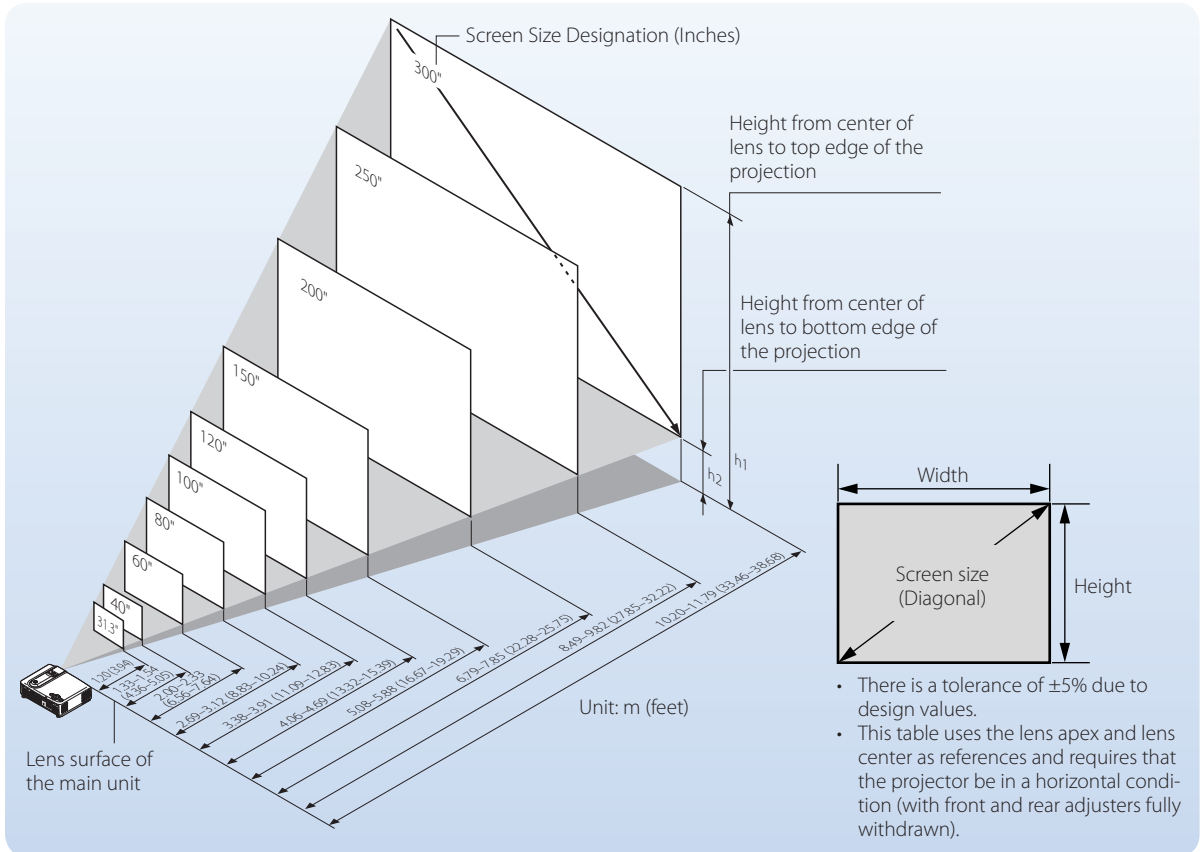

Screen Size Designation (Inches)	Screen Size Width × Height		Projection Distance		Height h1		Height h2	
	(m)	(feet)	(m)	(feet)	(m)	(feet)	(m)	(feet)
31.3"	0.64 × 0.48	2.09 × 1.57	— – 1.20	— – 3.94	0.53	1.73	0.05	0.16
40"	0.81 × 0.61	2.67 × 2.00	1.33 – 1.54	4.36 – 5.05	0.67	2.20	0.06	0.20
60"	1.22 × 0.91	4.00 × 3.00	2.00 – 2.33	6.56 – 7.64	1.00	3.30	0.09	0.30
80"	1.63 × 1.22	5.33 × 4.00	2.69 – 3.12	8.83 – 10.24	1.35	4.43	0.13	0.43
100"	2.03 × 1.52	6.67 × 5.00	3.38 – 3.91	11.09 – 12.83	1.68	5.52	0.16	0.52
120"	2.44 × 1.83	8.00 × 6.00	4.06 – 4.69	13.32 – 15.39	2.02	6.62	0.19	0.62
150"	3.05 × 2.29	10.00 × 7.50	5.08 – 5.88	16.67 – 19.29	2.53	8.29	0.24	0.79
200"	4.06 × 3.05	13.33 × 10.00	6.79 – 7.85	22.28 – 25.75	3.36	11.02	0.31	1.02
250"	5.08 × 3.81	16.67 × 12.50	8.49 – 9.82	27.85 – 32.22	4.20	13.78	0.39	1.28
300"	6.10 × 4.57	20.00 × 15.00	10.20 – 11.79	33.46 – 38.68	5.04	16.54	0.47	1.54

# Connecting Personal Computers and Video Equipment

## Connections with the Personal Computer

Connecting the projector with a personal computer permits the video of the personal computer to be projected to a large sized screen at meetings, lectures, and on other occasions.

Please check the following before making connections with the personal computer.

- An appropriate resolution for the **KG-PV131S** is 800 × 600 dots (S-VGA), and the maximum displayable resolution is 1024 × 768 dots (XGA).
- An appropriate resolution for the **KG-PS232Xh/232X** and **KG-PV131X** is 1024 × 768 dots (XGA), and the maximum displayable resolution is 1280 × 1024 dots (S-XGA).

Please change to a displayable resolution at the PC side when the aforementioned maximum displayable resolution is exceeded. See “Table of Supported Frequency” for details. See Page E-94.

The screen resolution setting method of the personal computer will differ depending on the specific model. Please read the personal computer instruction manual or the on-line help information, or contact the manufacturer of your personal computer.

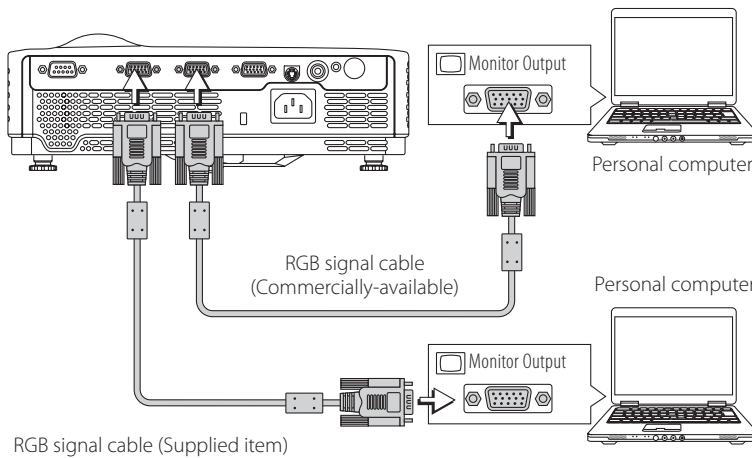

Connect the COMPUTER IN 1/2 connector of the projector with the video output connector of the personal computer using the supplied RGB signal cable or a commercially-available one.

- When making connections, align the orientation of the connectors and insert them. Then, turn the knobs and secure to the connector of the projector.
- The factory default input signal setting is set to **Auto**; however, if there is no projection, change the setting of the input signal to Computer with **Advanced Menu ▶ Input ▶ Computer 1/2**. See “Input” for details about the setting of input signals. See Page E-74.

### Note

- Use of a cable longer than the supplied RGB cable or extension of the cable might result in the generation of noise or deterioration of the image. When a long cable is used, we recommend the use of a noise canceller or other devices. Contact an installer or other professional for details.
- Setting the output frequency of the personal computer to 60 Hz will result in the display of the clearest video.

### Technical Point

#### What is an RGB connector?

This is a connector used for transferring video signals to a monitor or other equipment. The three colors R (red), G (green), and B (blue) are separated and transferred as an analog signal with this system. The display of a personal computer is expressed by the RGB color space, and synthesizing the three colors permits all colors to be reproduced. These connectors mainly use a standard called mini D-Sub 15-pin that describes their form, and control signals used for signal synchronization, as well as other signals, are transferred at the same time as the RGB color signal.

#### What are supported frequencies?

Supported frequencies is a term that indicates the breadth of the scanning frequencies that this projector supports. The scanning frequencies express the speed when the display is drawing the screen. The number of lines that can be drawn in 1 second are called the horizontal scanning frequency, and the number of times the screen is overwritten in 1 second is called the vertical scanning frequency. The higher the scanning frequency, the higher the resolution or the greater the number of simultaneously expressed colors can will be possible, and a display having little flicker can be produced. As an example, a display having a vertical scanning frequency of 70 Hz can draw the screen 70 times in 1 second.

### Technical Point

This projector is equipped with two COMPUTER IN connectors. When two personal computers are used in meetings or classes, they can both be connected to the projector at the same time.

- One RGB cable is supplied with this projector. When the projector is used with two computers, please purchase an additional commercially-available RGB cable.
- When two personal computers are connected, the video that is detected first will be projected. To switch the video, press the SOURCE button of the projector or the remote control and switch the input.

## Connecting Personal Computers and Video Equipment

### To Output the External Output Signal of a Notebook Computer

When connecting a notebook computer, knowledge will be required for the cable connection and notebook computer startup procedure as well as the operation that follows notebook computer startup. Please consult the instruction manual of your notebook computer or the on-line help while performing the following procedure.

#### 1. Check whether a signal is being sent from the notebook computer to this projector.

An indication appearing on the liquid crystal display of the notebook computer does not necessarily mean that an external output signal is being output.

#### 2. When a signal is not being output from the notebook computer, take steps to output an external output signal.

The output method of the external output signal will differ depending on the personal computer manufacturer. See the table below for details.

Manufacturer	Key
ACER	Fn + F5
DELL	Fn + F8
EPSON	Fn + F8
FUJITSU	Fn + F10
Hewlett-Packard	Fn + F4
IBM	Fn + F7
Lenovo	Fn + F7
NEC	Fn + F3
Panasonic	Fn + F3
SHARP	Fn + F5
SONY	Fn + F7
SOTEC	Fn + F3–F5
TOSHIBA	Fn + F5

Note: The content of the table is current as of December, 2007.

#### Note

When the liquid crystal screen of the notebook computer and the projector image are displayed at the same time, the projected image might not be correct even though the liquid crystal screen displays the correct image. Should this occur, stop the simultaneous display of the notebook computer and try the mode with external output only. Try an operation such as that described in step 2 at the left, and try closing the liquid crystal panel which might result in external output only.

# Connecting Personal Computers and Video Equipment

## Connections with Typical Video Equipment

This product can project the video from a wide variety of video equipment including video decks, television, and video cameras, etc.

### Using RCA Jacks

- Connect to the projector's VIDEO IN connector using a commercially-available video cable.
- The factory default input setting of the VIDEO IN connector is set to **Auto**; however, if there is no projection, change the input setting with **Advanced Menu** ▶ **Input** ▶ **Video**. See "Input" for details. See Page E-74.

### Using S-Video Connectors

- Connect to the projector's S-VIDEO IN connector using a commercially-available S-video cable.
- The factory default input setting of the S-VIDEO IN connector is set to **Auto**; however, if there is no projection, change the input setting with **Advanced Menu** ▶ **Input** ▶ **S-Video**. See "Input" for details. See Page E-74.

### Technical Point

#### What is a RCA Connector, and a S-Connector?

Several types of connectors are used as video connectors including composite video connectors, separate video connectors, and component video connectors.

Composite video connectors are usually called pin jacks or RCA jacks, and they are mainly included on video decks, document cameras, etc.

Separate video connectors are most typically called S-video, and because they take the form of mini DIN 4-pin connectors, mini DIN 4-pin may also be used to describe S-video.

Component video connectors are called color-difference input connectors. The usual NTSC (480i) signal connector that transfers the C color signal which is divided into the B-Y color-difference signal Cb (Pb), and the R-Y color-difference signal Cr (Pr) is described as Y/Cb/Cr. Connectors that can be used for video formats above NTSC may be described as Y/Pb/Pr.

### Technical Point

#### What is a ferrite core?

These are accessories that are used to reduce the radiated noise from the interface cables of digital equipment and other devices. When a high frequency current that is the source of noise flows in a cable, it will generate a magnetic field and noise will be emitted. The ferrite core absorbs this and converts it to heat which is radiated. Attaching a ferrite core will reduce the deterioration of the picture.

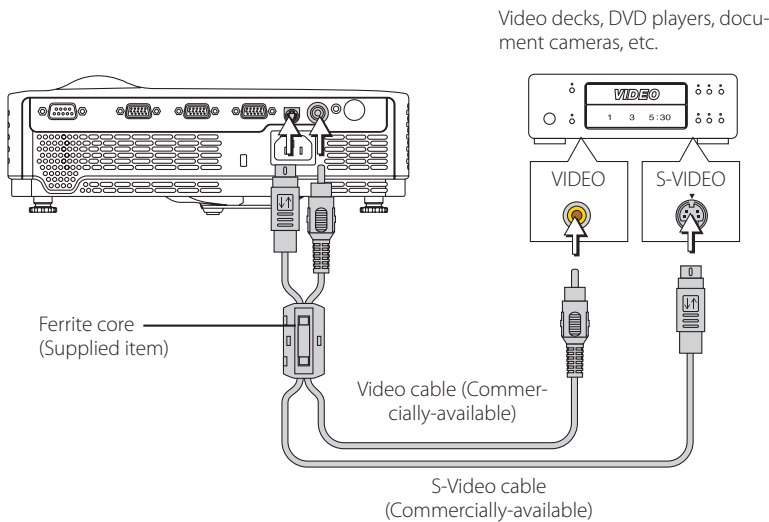

### Attaching the Ferrite Core

Place side-by-side the commercially-available video cable and the S-video cable as illustrated in the diagram and attach the supplied ferrite core.

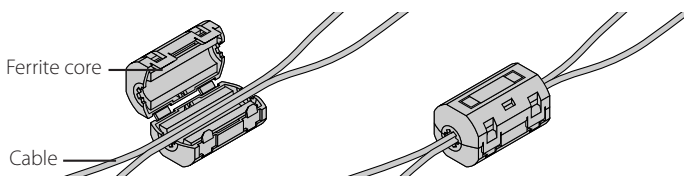

# Connecting Personal Computers and Video Equipment

## Using YCbCr Connectors or YPbPr Connectors

- Use a commercially-available conversion cable to connect with the COMPUTER IN 1/2 connector of the projector.
- The factory default input setting of the COMPUTER IN 1/2 connector is set to **Auto**; however, if there is no projection, change the input setting with **Advanced Menu ▶ Input ▶ Computer 1/2**. See "Input" for details. See Page E-74.
- When projecting the YCbCr signal or YPbPr signal, if the color of the overall image strongly leans toward being greenish or another color, change the setting under **Advanced Menu ▶ Color ▶ Color Space**. See "Color Space" for details. See Page E-72.

### Technical Point

#### What is YCbCr Connector, and a YPbPr Connector?

Several types of connectors are used as video connectors including composite video connectors, separate video connectors, and component video connectors.

Composite video connectors are usually called pin jacks or RCA jacks, and they are mainly included on video decks, document cameras, etc.

Separate video connectors are most typically called S-video, and because they take the form of mini DIN 4-pin connectors, mini DIN 4-pin may also be used to describe S-video.

Component video connectors are called color-difference input connectors. The usual NTSC (480i) signal connector that transfers the C color signal which is divided into the B-Y color-difference signal Cb (Pb), and the R-Y color-difference signal Cr (Pr) is described as Y/Cb/Cr. Connectors that can be used for video formats above NTSC may be described as Y/Pb/Pr.

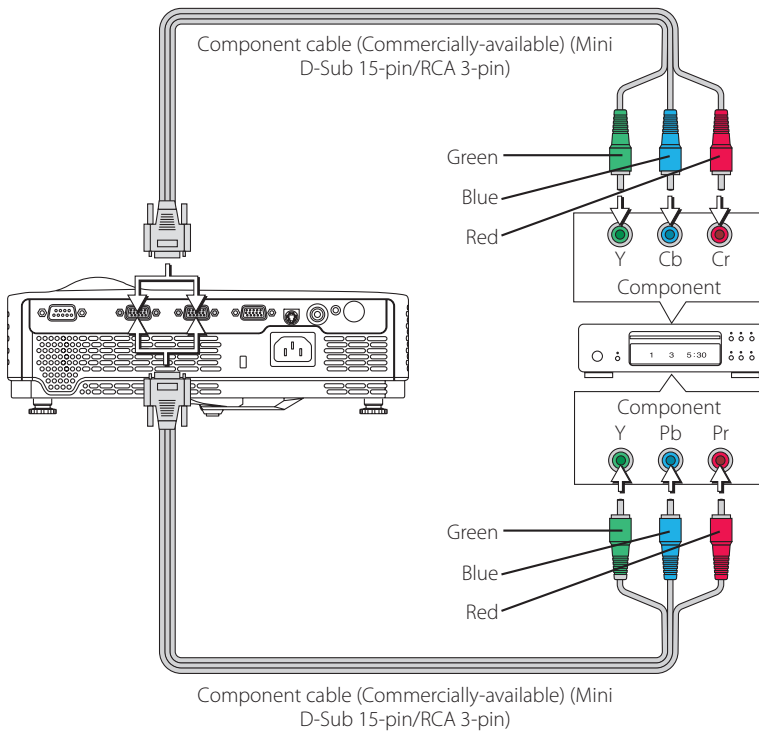

# Connecting Personal Computers and Video Equipment

## Connections with the AUDIO Jacks

- Connect to the projector's AUDIO IN jacks using a commercially-available audio cable. Use a commercially-available audio conversion adapter to make the connection when the audio connectors of the equipment to be connected are RCA phono jacks.
- The built-in speaker of the projector provides monaural audio. To enjoy impressive audio, connect the audio output of the projection equipment to your audio system.
- The built-in speaker will output the audio of the equipment that is connected to the AUDIO IN jacks.

**Note**

Audio will not be output when there is no projection.

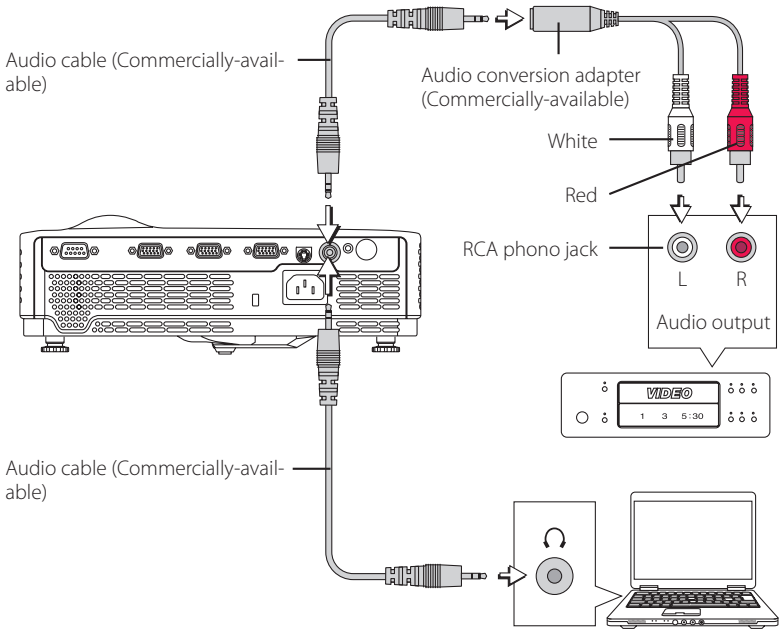

## Connecting Personal Computers and Video Equipment

### Connections with the MONITOR OUT Connector

- The video of the personal computer connected to COMPUTER IN 1/2 is output.
- Among the COMPUTER IN 1/2 connections, the video of the selected input will be output.
- Inputs other than COMPUTER IN 1/2 cannot be output.

#### Technical Point

When the MONITOR OUT connector is used to connect two projectors as illustrated in the diagram below, the same image can be viewed on two large screens. This is convenient when a large number of people are viewing the same image at a lecture meeting, etc. Also, when a liquid crystal display is connected, the same image as that projected by the projector can be viewed and this is convenient for personal computer operation at a position from which the screen is not visible, or when projecting to a rear projection screen.

#### Note

The video signal from the MONITOR OUT connector will show deterioration in comparison with the input signal. Also, when multiple projectors are connected, noise may occur in the video. Thank you for your understanding in advance.

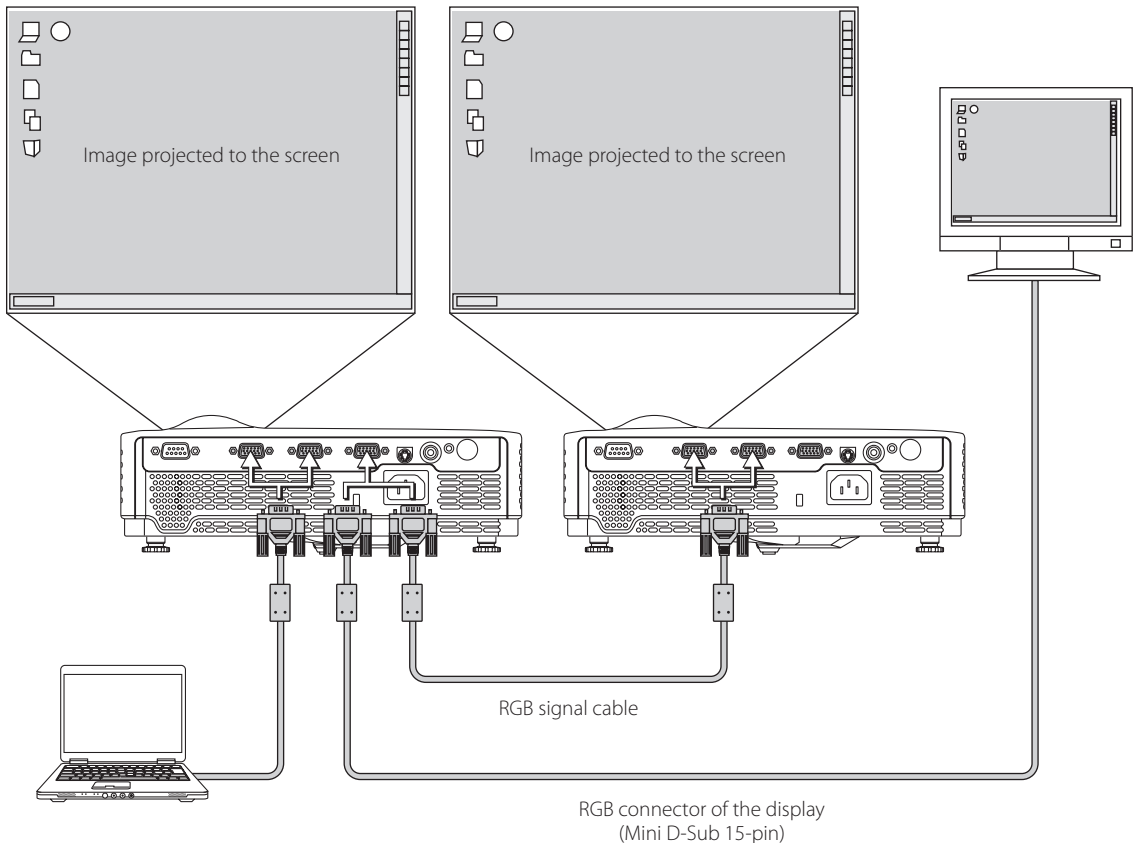

## Connecting Personal Computers and Video Equipment

### Connections with the RS-232C Connector

- Connect the RS-232C connector of the control equipment with the RS-232C connector of the projector using a commercially-available serial cable (of the D-Sub 9-pin straight type).

 **Note**

The connection might not work depending on the control equipment. Thank you for your understanding in advance. Specialized knowledge is required to use the RS-232C connector. Please contact an installer or other professional for help.

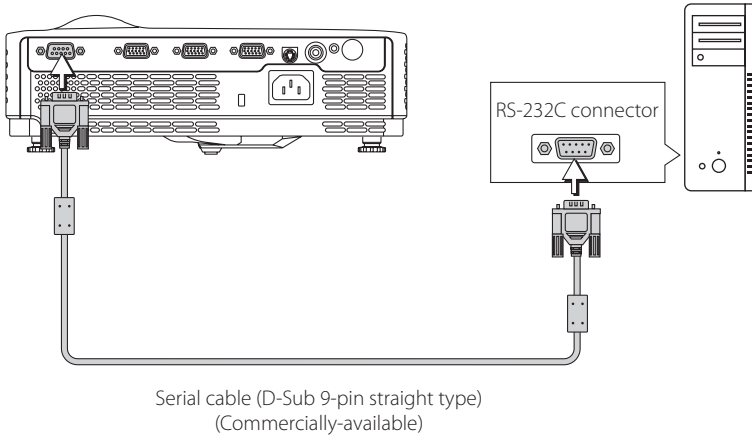



# Turning On the Power

## 1 Connect the Power Cable

Connect the AC IN connector of the projector and the power outlet using the supplied power cable.

The indicator of the POWER/STANDBY button will light in orange and the projector will enter the standby mode.

To wall outlet  
\* Only connect to a grounded power outlet.

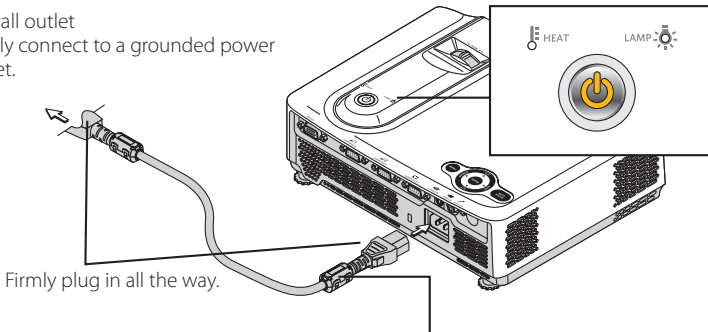

Firmly plug in all the way.

### ! Precautions

- When the power plug will be unplugged from the power outlet, please place the projector near the power outlet so that it may be reached easily.
- The supplied power cable is a dedicated product for this projector. Never use it with another product.
- Press the POWER/STANDBY button after the projector POWER/STANDBY button indicator is lit orange.

### ! Precautions

For usage, please connect this product to the electrical outlet with the grounding wire.

(Laitte on liitettava suojamaadoitus-koskettimilla varustettuun pistorasiaan)

(Apparatet må tilkoples jordet stikkontakt)

(Apparaten skall anslutas till jordat uttag)

This product is designed to be connected with "IT POWER SYSTEM" of Norwegian.

## Attaching the Ferrite Core

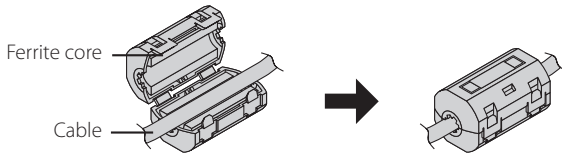

## 2 Opening the Lens Shutter

Turn the lens shutter clockwise. Projection will be possible when the lens shutter has stopped with a click sound.

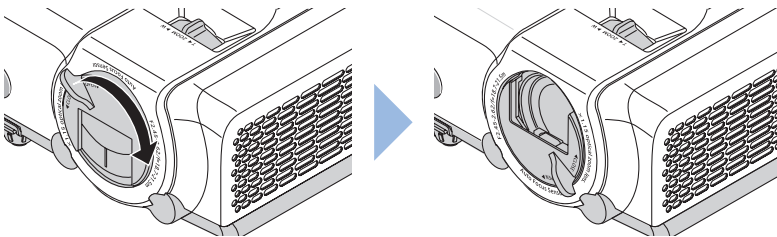

Continued on next page →

### 📖 Technical Point

Closing the lens shutter during projection will automatically activate Blanking/Muting of the video/audio. This is a convenient function that temporarily makes the video go blank.

# Turning On the Power

## 3 Turning On the Projector Power

Press the POWER/STANDBY button of the remote control or the projector.

- A press of the POWER/STANDBY button will change the indicator of the POWER/STANDBY button from the orange of the standby mode to flashing blue during startup, and it will flash for approximately 60 seconds.
- When, after the indicator has flashed for approximately 60 seconds, it slowly flashes in green, the Eco mode will be set to **On**. For information about the Eco mode setting method see “Eco Mode” on Page E-56.
- When the LAMP/HEAT indicator is lit but the power does not turn on, see “When an indicator is lit or flashing”. See Page E-83.

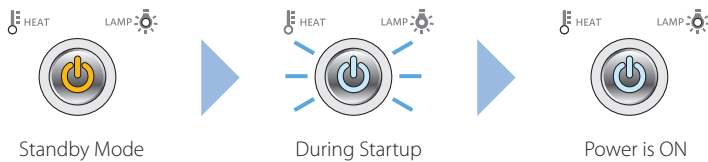

## Turning On the Power for the First Time after Purchase

The initial setting screen will be displayed when the power is turned on for the first time after purchase. Following the steps described below, perform the initial settings.

- If the video is blurred when using the **KG-PV131X/131S**, use the focus ring to adjust the focus.
- Operations are all made using the cursor buttons and ENTER button of the remote control or the projector.

### 1. Language setting: Sets the language that will be displayed.

Aligning the blue cursor with **English** and pressing the ENTER button will select English. After checking the selected item, press the ► cursor button and proceed to the next setting.

## Technical Point

- The projector is equipped with a Quick-start function. The video will be projected a little over ten seconds after pressing the POWER/STANDBY button.
  - \* The video will be projected; however, because the projector is starting up, the POWER/STANDBY button indicator will continue to flash in blue.
- The projector is equipped with a function that performs a password setting for the purpose of security protection. When the password setting is performed, a screen will be displayed such as the one illustrated below, and use of the projector will not be possible unless a password is entered. See “Set Password” for details. See Page E-75.



## Note

**While the POWER/STANDBY button indicator of the projector is flashing in blue, it will not be possible to turn off the power. Check that the indicator has become a steady blue, or a slow-flashing green and then turn off the power.**

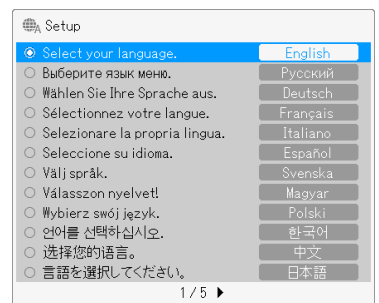

### 2. Auto Focus setting (KG-PS232Xh/232X only): Sets the auto focus function to On or Off.

To use the auto focus function, align the cursor with **On** and press the ENTER button. (The factory default setting is **On**.) When you will not be using the auto focus function, align the cursor with **Off** and press the ENTER button. After selecting either **On** or **Off**, press the cursor button and proceed to the next setting.

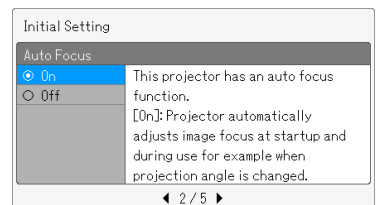

## Turning On the Power

### 3. Auto Keystone: Sets the auto keystone correction function On or Off.

To use the auto keystone function, align the cursor with **On** and press the ENTER button. (The factory default setting is **On**.)

When the auto keystone function is not going to be used, align the cursor with **Off** and press the ENTER button.

After selecting either **On** or **Off**, press the cursor button and proceed to the next setting.

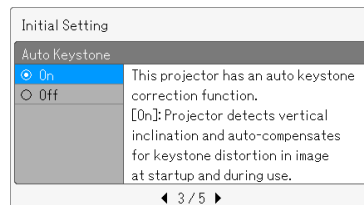

### 4. Startup Screen: Performs the settings of the image that is displayed at startup.

Align the cursor with **Logo** or **None** and press the ENTER button. (The factory default setting is set to **Logo**.)

After selecting either **Logo** or **None**, press the cursor button and proceed to the next setting.

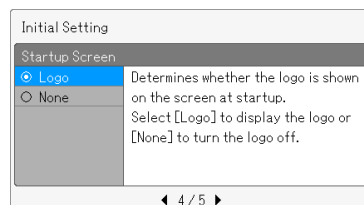

### 5. Background Color: Sets the background color when the screen is blanked temporarily or when there is no signal.

Align the cursor with **Blue** or **Black** and press the ENTER button. (The factory default setting is **Blue**.) Select either **Blue** or **Black**, and then align the blue cursor with **Initial Setting Complete** and press the ENTER button. The screen will close and the initial setting will be completed.

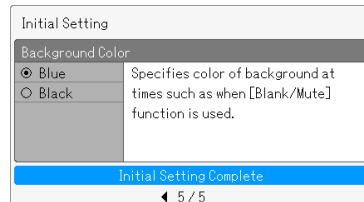
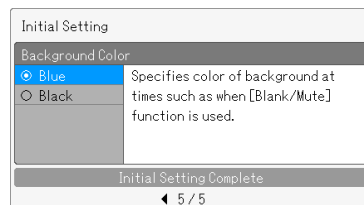

#### Note

The initial settings screen will not be displayed from the second time the projector is turned on. Please check the following matters when changing the content of the initial settings.

- Change of language setting "Select Language" See Page E-62
- Change of Auto Focus setting (KG-PS232Xh/232X only) See "Auto Focus" on Page E-53.
- Change of Auto Keystone setting "Auto Keystone" See Page E-53
- Change of Startup Screen setting "Startup Screen" See Page E-81
- Change of Background Color setting "Background Color" See Page E-82

## Properly Adjusting the Projected Image to the Screen

Make the adjustments with the power of the connected equipment turned on, and the video signal input to the projector.

### Adjusting the Projected Image.

#### 1 Turn the zoom ring and adjust the size of the projected image.

Adjust so that the desired image size is obtained. When the size does not match by adjusting the zoom ring, move the projector back or forward.

KG-PS232Xh/232X

KG-PV131X/131S

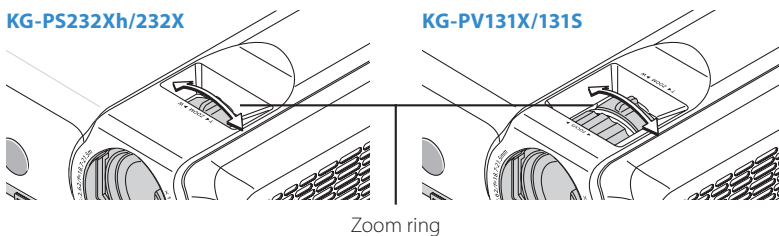

#### 2 Adjusting the Projected Image to the Screen

Check that the screen is set horizontally and vertically.

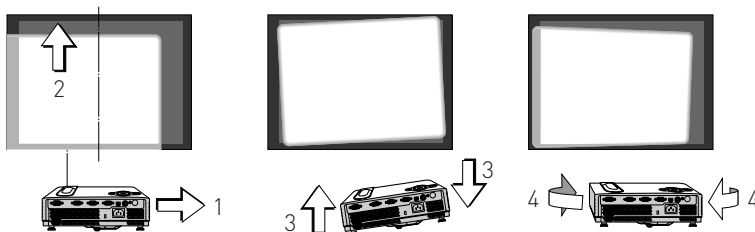

1. When shifted in the left-right direction, move the projector to the side. (Align the center of the screen with the center of the projector lens.)
2. When shifted in the vertical direction, adjust using the front adjuster.
3. When on an angle, adjust by turning the right or left rear adjuster.
4. In a projected screen such as that illustrated, the projector is facing the side with respect to the screen; therefore, place the projector so that it is facing the screen straight from the front.

#### Technical Point

The projector is equipped with an Auto Keystone function. Keystone distortion in the vertical direction as illustrated in the diagram will be corrected automatically. The keystone distortion will be adjusted automatically about 3 seconds after determining the projection angle. A message reading "Auto Keystone Complete" will be displayed for about 1.5 seconds.

See "Manual Adjustment of Keystone" when making fine adjustments after automatic adjustment. See Page E-43.

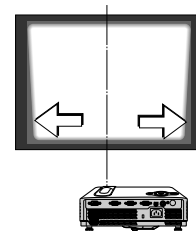

- When **Auto Keystone** is set to **Off**, it will not function. See "Auto Keystone" for details about setting Auto Keystone. See Page E-53.
- The operating conditions of Auto Keystone are as described below.
  - Operation will be in a range of approximately 2° to 18° in the vertical direction.

#### ! Note

Correction might not be possible when the screen is on an angle, or when the temperature in the vicinity of the projector is extremely high or low.

## Properly Adjusting the Projected Image to the Screen

### 3 Adjusting the Focus

- Model **KG-PS232Xh/232X** is equipped with an Auto Focus function. Turning the zoom ring as described in step **1** will result in automatic adjustment of the focus.
- For model **KG-PV131X/131S**, turn the focus ring and adjust the focus of the screen.

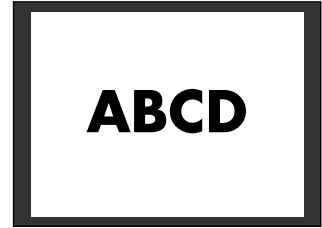
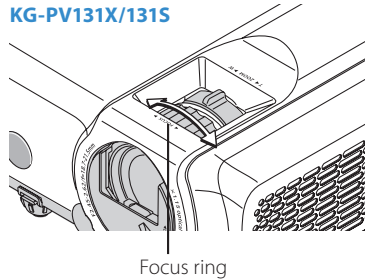

#### Technical Point

Model **KG-PS232Xh/232X** is equipped with an Auto Focus function. Turn the zoom ring, or press the AUTO FOCUS button of the remote control or the projector to adjust the focus automatically.

- The operating conditions of Auto Focus are as described below.
  - When the power is turned on
  - When the zoom lever is moved
  - When the projector is moved
  - When the projection angle has been changed
- Auto focus operating range
  - Auto focus will work with screen sizes ranging from 31 inches (with a projection distance of 1.2 m) to 148 inches (with a projection distance of 5 m). Adjust the focus manually when screen placement exceeds 5 m.
  - Depending on the color of the screen and the projection environment, the operating range might be shorter, or proper operation might not be obtained.
  - Erroneous operation will result when there is an obstacle between the focus sensor and the screen.
  - Erroneous operation will result with the use of a translucent screen.
  - This function will not operate when the screen has been moved.

#### Note

**Change the projection method when the projector is installed suspended from the ceiling, or is in a rear projection setup. See "Vertical Flip / Horizontal Flip" on Page E-68.**

# Turn off the power after projection is finished

## 1 Turning Off the Projector Power

Press the POWER/STANDBY button of the remote control or the projector.

- This message will be displayed: Turning power off – Press "POWER/STANDBY" to proceed. (Press "MENU" to cancel.)

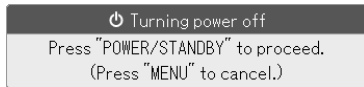

- Following the message, a press of the POWER/STANDBY button will cause the screen to go blank and will enter the projector into the power off operation.
- The POWER/STANDBY button must be pressed while the message is displayed if the power is to be turned off.
- A press of the MENU button while the message is displayed will cause the message to be deleted and will return the projector to the power On condition.
- The indicator of the POWER/STANDBY button will change to a flashing blue, then go off about 90 seconds later, and the indicator will light in the orange of the standby mode.

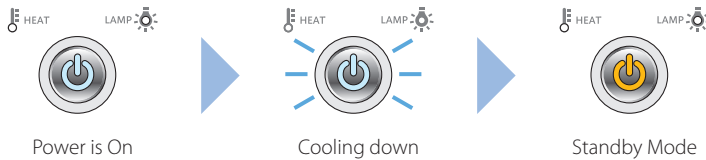

### Technical Point

The projector is equipped with a Quick-off function. Even when the power cord is unplugged soon after turning off the power, the internal power supply will power the rotation of the cooling fan and cool the lamp allowing immediate removal.

- After cooling the projector with the power cable connected, relighting of the lamp might become difficult.
- Do not place the projector in a bag or other enclosure while the cooling fan is turning.

## 2 Disconnect the Power Cable

When the Quick-off function is not being used, check that the indicator of the POWER/STANDBY button is lit in orange and then disconnect the power cable. When the power cable is disconnected, the indicator of the POWER/STANDBY button will go off.

## 3 Closing the Lens Shutter

Turn the lens shutter counterclockwise until it stops with a click sound.

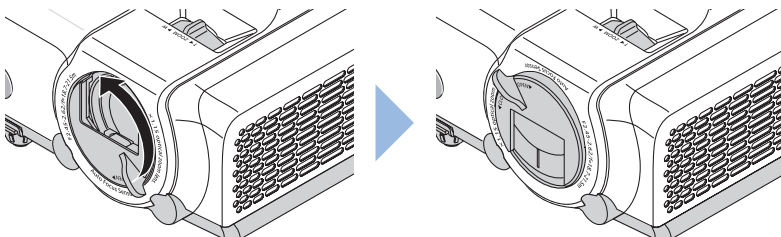

## Regular Operation

This section describes the use of direction operation with the buttons of the projector and the remote control. See “Using the Menu” for details about operation by using the menu. See Page E-46.

### Selection of Input Signal

Select the input source that is to be projected.

- Press SOURCE button.
- A message like the one to the right will be displayed on the projection screen. Each press of the cursor buttons (▲▼) will move the cursor. Select the source that you would like to project and press the ENTER button to finalize.
- When **Auto Detect** is **On** and there is no input signal at the selected source, the source having an input signal will be selected automatically.
- When **Auto Detect** is **Off**, there will be switching to the selected source regardless of the presence or absence of an input signal.
- See “Auto Detect” for details about the On/Off setting of the Auto Detect function. See Page E-51.

Input Select	
Computer 1	1024x768 60Hz
Computer 2	<input type="radio"/>
Video	<input type="radio"/>
S-Video	<input type="radio"/>

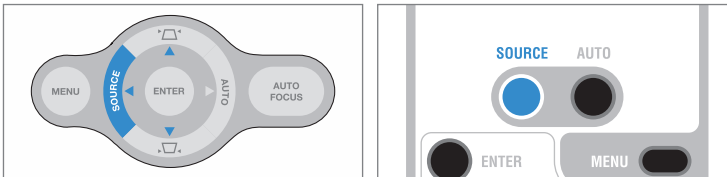

### Automatic Adjustment

This function performs automatic adjustments of the projected RGB input signal position shift, the size of the screen image, vertical stripes, and color shift. Usually, the video is adjusted automatically at the time of input selection.

- Press AUTO button.
- Press the button to start automatic adjustment.
- When the display position is shifted, there are vertical stripes on the screen or other instances of a poor projection even though automatic adjustment has been performed, adjust the video manually. See “Image” for details. See Pages E-63 to 65.

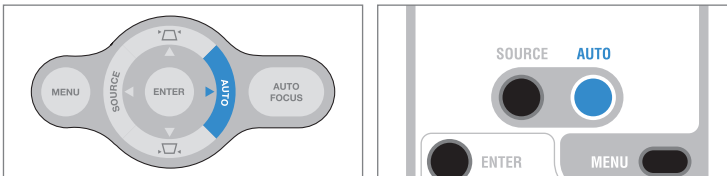

#### Note

When the video extends beyond the screen or is smaller than the screen, set the aspect ratio setting to **Auto**. See “Select Aspect Ratio” on Page E-66.

## Basic Operation

# Regular Operation

### Auto Focus KG-PS232Xh/232X only

- A press of the AUTO FOCUS button activates the Auto Focus function, and adjusts the focus automatically.
- When the **Auto Focus** setting is **On**, the focus will be adjusted automatically when the size of the projected image is adjusted with the zoom ring, or when the angle of the screen is adjusted; however, if the adjustment has not been favorable or **Auto Focus** is set to **Off**, use this button to adjust the focus.

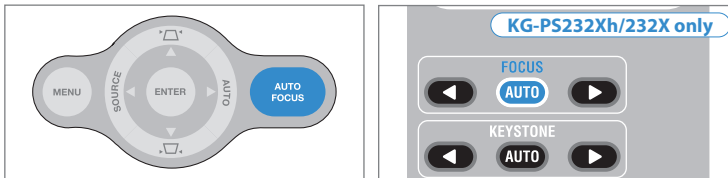

### Auto Keystone

- A press of the AUTO KEYSTONE button activates the Auto Keystone function, and automatically corrects the keystone distortion of the projected video.
- When the setting of **Auto Keystone** is **On**, the vertical keystone correction will be performed automatically when the projector is tilted up or down, etc.



### Technical Point

#### What is Keystone Distortion?

Keystone distortion is distortion of the projected image that occurs when the projector is tilted vertically or horizontally with respect to the screen.

There are two types of keystone distortion, in the horizontal direction when the projector is slanted to the left or right, and in the vertical direction when the projector is tilted up or down. This projector can manually or automatically correct the distortion in the vertical direction.

### Temporarily Blanking/Muting the Video/Audio

This convenient function can be used when you would like to temporarily blank the video and mute the audio.

- A press of the BLANK button will blank the video, and the background color of the setting (blue or black) will be set.
- To project the image or video again, press a button with the exception of the POWER/STANDBY button.

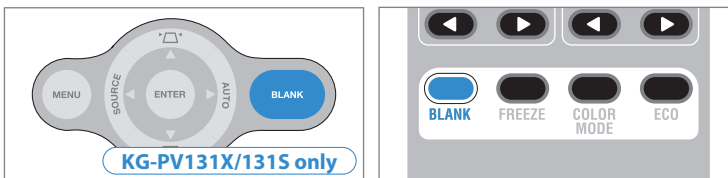

### Technical Point

Closing the lens shutter of the projector will automatically activate Blanking/Muting of the video/audio.

This is a convenient function when you do not have a remote control handy, or you would like to temporarily blank the video.



## Regular Operation

### Pausing the Video

This convenient function can be used when you would like to temporarily stop the video.

- A press of the FREEZE button will stop the video at that instant.
- This is a convenient function that allows a movie to be stopped, or a screen to be stopped during projection to permit searching for another document.
- A further press returns the screen to a moving picture.

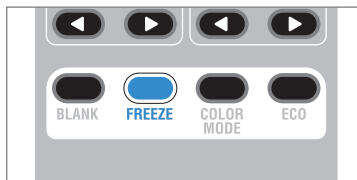

### Projection Mode Selection

This projector already has projection modes set that suit the application.

- A press of the COLOR MODE on the remote control will display the selection screen.
- Using the COLOR MODE on the remote control, select the desired projection mode and press the ENTER button.

Projection Mode : Standard

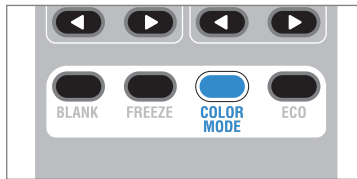

\* The projection modes that can be selected will differ depending on the input source. See the table below for details.

Input Source	Setting Item	Setting Content
Computer 1/2 (RGB signal)	Standard	This is the standard setting.
	Graphics	A setting that prioritizes color reproducibility. Brightness will drop, but color reproducibility will rise. This is recommended for projection of photographs and animation.
	Presentation	A setting that prioritizes brightness. Color reproducibility will drop, but brightness will rise. This is recommended when projecting in a bright location.
	Blackboard	This is an optimum setting when projecting onto a blackboard.
	Custom	A setting that will apply the value that was set with <b>Color</b> under the <b>Advanced Menu</b> .
Computer 1/2 (Component signal) Video S-Video	Standard	This is the standard setting.
	Movie	This is an optimum setting when projecting a movie.
	Blackboard	This is an optimum setting when projecting onto a blackboard.
	Custom	A setting that will apply the value that was set with <b>Color</b> under the <b>Advanced Menu</b> .

## Regular Operation

### Eco Mode KG-PS232Xh/232X only

This function can limit the power consumption of the projector to permit the lamp to be used longer. By limiting the power consumption, the brightness will drop; however, the service life of the lamp will be longer than with normal use. This function can be used effectively for example when the screen is too bright when projecting onto a small screen, or when the brightness drops when projecting an image or video in a dark room.

- Press the ECO button to change to the Eco mode.

**On:** POWER/STANDBY button indicator flashes slowly in green. The brightness of the lamp will be approximately 80% of normal, and the service life of the lamp will be extended.

**Off:** POWER/STANDBY button indicator lights steadily in blue. The brightness of the lamp will be 100%, and there will be bright video.

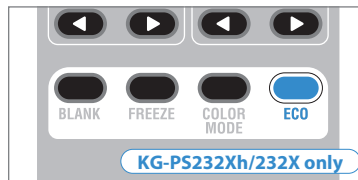

### Note

Please note that frequent switching of the Eco mode will cause deterioration of the lamp.

### Manual Adjustment of Focus KG-PS232Xh/232X only

This projector is equipped with automatic and manual focus adjustment functions.

Manual adjustment will be described here.

- Press the FOCUS button of the remote control (◀▶), and adjust the focus. A press of the button will display the focus adjustment display.
- To close the display soon after the adjustment, press the MENU button of the remote control or the projector. The display will close automatically when there has not been an operation in about 10 seconds.



## Regular Operation

### Manual Adjustment of Keystone

This projector is equipped with an auto and a manual keystone correction function. Manual adjustment will be described here.

- Press the KEYSTONE buttons (◀▶) of the remote control or the KEYSTONE buttons of the projector and perform the keystone correction. A press of the button will display the keystone correction display.
  - To close the display soon after the adjustment, press the MENU button of the remote control or the projector. The display will close automatically when there has not been an operation in about 10 seconds.
- \* When **Auto Keystone** is **Off**, the adjustment value of the keystone correction will be stored after the power is turned off.
- \* See "Auto Keystone" for details about the auto keystone correction function. See Page E-53.

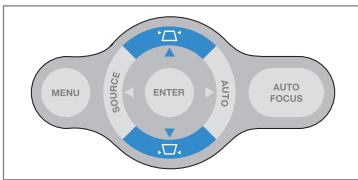

### Volume

This is the volume adjustment of the speaker that is built into the projector.

- Press the VOLUME button of the remote control (◀▶), and adjust the volume. A press of the button will display the volume adjustment display.
  - To close the display soon after the adjustment, press the MENU button of the remote control or the projector. The display will close automatically when there has not been an operation in about 10 seconds.
- \* Adjustment of the volume will not be possible unless video is being projected.

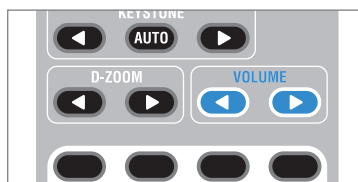

## Regular Operation

### Enlargement of the Video and Image Movement

This function digitally enlarges projected images and video.

- Press the D-ZOOM button of the remote control (▶), and enlarge the video.

A press of the D-ZOOM button will display the zoom adjustment display.  
Each press of ▶ will further enlarge the video. (Up to 200%)

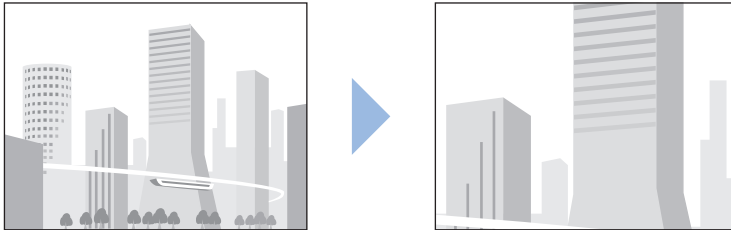

Each press of ◀ will return the video to its original state. (To 100%)

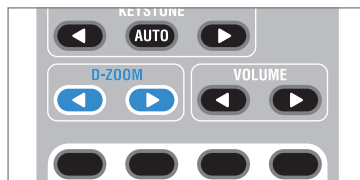
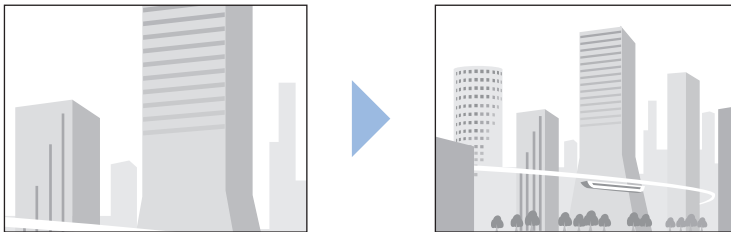

#### Note

- Zoom and Image Movement will be cancelled by switching the input, or changing [Select Aspect Ratio](#).
- The larger the enlargement using Zoom, the more the image will appear blurred. The reason for this is that digital correction is applied so that the dots do not stand out.
- The projected image cannot be moved while the menu screen is displayed.

## Regular Operation

- Pressing the cursor buttons (▲▼◀▶) of the remote control while an image is enlarged will result in movement of the display position.

\* When enlargement has not been applied (i.e., Zoom is 100%), there will not be any movement.

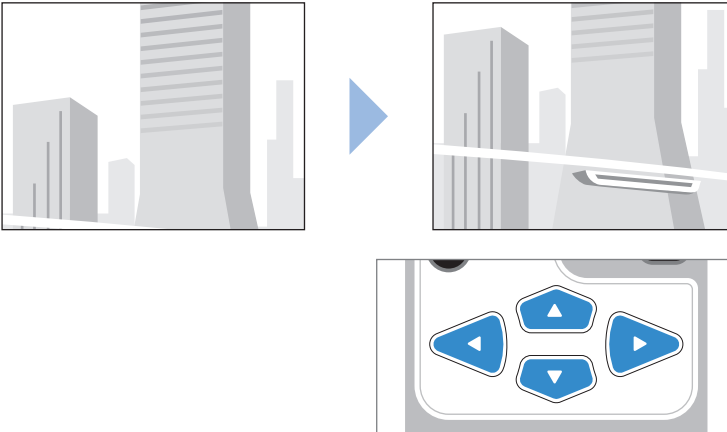

- To close the display right away, press the MENU button of the remote control or the projector. The display will close automatically when there has not been an operation in about 10 seconds.

\* When finished with the enlargement operation, be sure to return the value of **Zoom** to **100**.

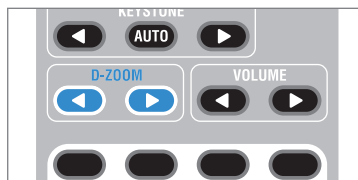

# Menu Operation Method

The menu operation method will be introduced so that you can more conveniently use the projector.

- Please see the various explanatory pages about the adjustment/setting methods of the various settings.
- Direct the remote control toward the infrared sensor of the projector and operate it.
- The content that can be adjusted or set will differ depending on the input signal.
- See "Initialize" to return to the standard (factory setting) values the various items that have been changed using the menu. See Page E-81.
- To operate the menu, turn on the power of the connected equipment, set the equipment to the play mode or another suitable mode, and input a video signal to the projector.

## Menu Screen Names and Functions

**With respect to the "Simple" and "Advanced" screens, Simple Menu** has a light gray background color. Selecting **Show Advanced** will change the display to the **Advanced Menu**.

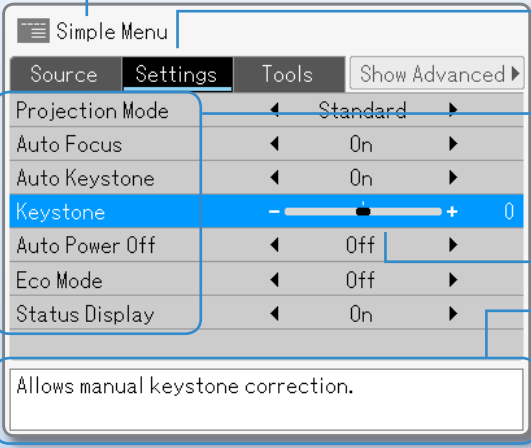

**Menu Name**  
This is the title of the menu. The color of the selected menu will change.

**Item Name**  
This is the name of the adjustment or setting. The (blue) cursor will move to the selected item.

**Adjustment Bar and Settings Contents**  
The increases and decreases in bar length express the adjustment condition. The set contents are displayed in characters.

**Help**  
A Help explanation related to the selected menu/item is displayed.

Allows manual keystone correction.

## Names and Functions of the Remote Control Buttons and Projector Buttons

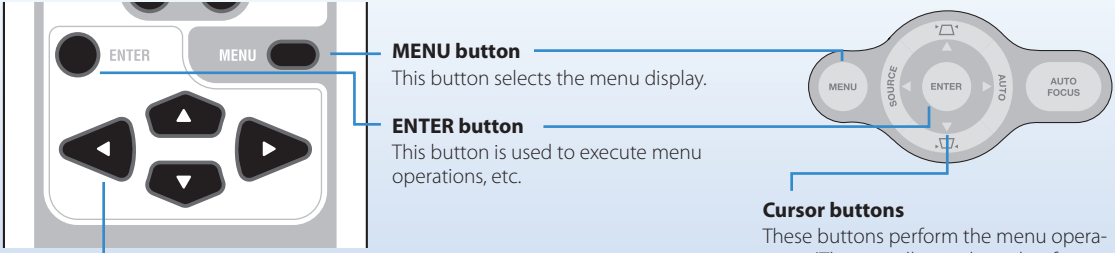

**MENU button**  
This button selects the menu display.

**ENTER button**  
This button is used to execute menu operations, etc.

**Cursor buttons**  
These buttons perform the menu operations. (They are allocated to other functions when the menu screen is not being displayed.)

**Cursor buttons**  
These buttons perform the menu operations.

# Menu Operation Method

## Using Menu Operations

- Some of the settings will not be usable unless a video signal is input.
- The menu display will close automatically when an operation has not been made within approximately 45 seconds of pressing the MENU button.
- The projector will store the adjustment and setting values even when the power is turned off. (There are some items that are not stored.)

### 1 Display the Menu Screen

Press the MENU button of the remote control or the projector and display the **Simple Menu**.

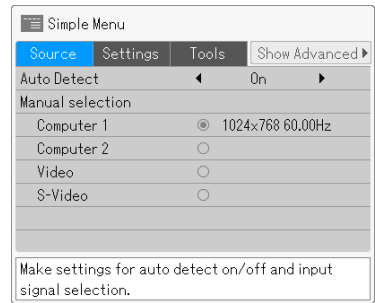
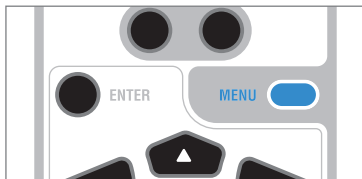
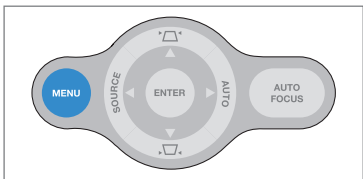

### 2 Select the Menu Name

Each press of the **▶** cursor button will move the selection one step in the sequence of **Source ▶ Settings ▶ Tools ▶ Show Advanced**. Each press of **◀** will return the selection one step. When a menu name is selected, the cursor of the item name will disappear.

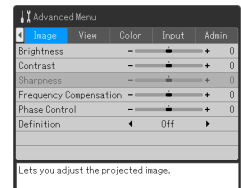
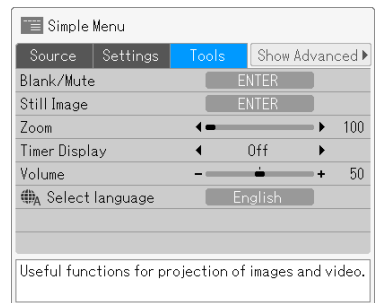
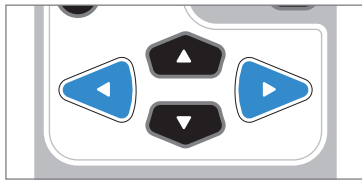
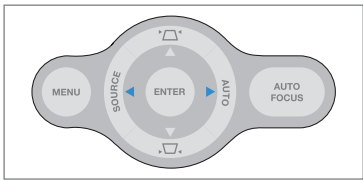

\* Selecting **Show Advanced** will switch the display to the **Advanced Menu**. The operation method is the same as for **Simple Menu**.

### 3 Select the Item Name

Press the cursor buttons (**▲▼**) and select the item name.

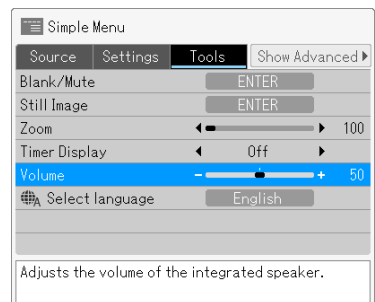
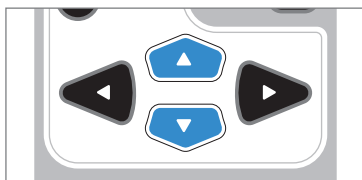
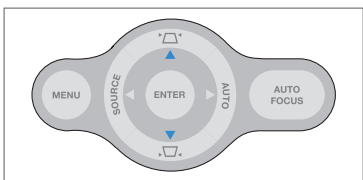

Continued on next page →

# Menu Operation Method

## 4 Making Adjustments and Settings

Press the cursor buttons (◀▶) and the ENTER button and make the adjustment or setting.

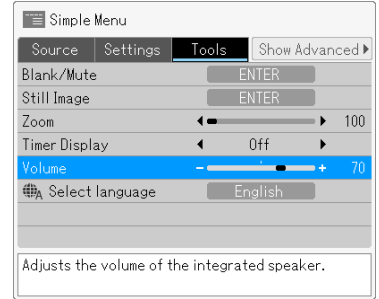
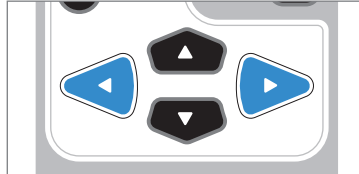
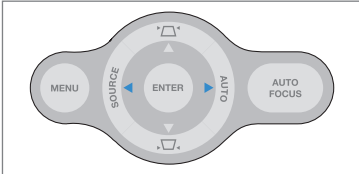

## 5 Close the Menu Screen

Press the MENU button and close the menu screen.

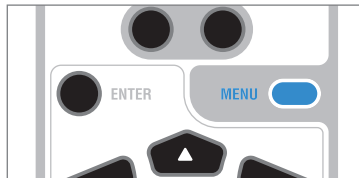
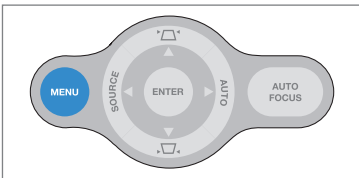

### To Select another Menu Item when an Item Name Is Selected

Press the cursor buttons (▲▼) and select the menu name.

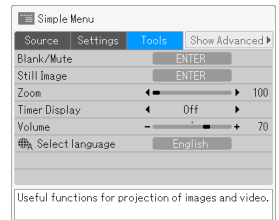
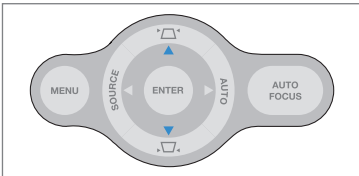

Check that the cursor of the item name has disappeared, then press the cursor buttons (◀▶) and select another menu name.

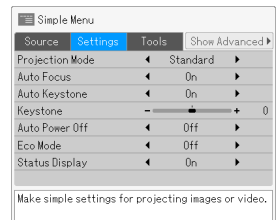
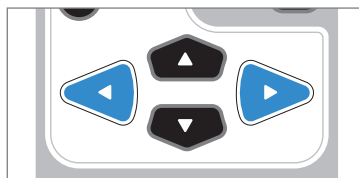
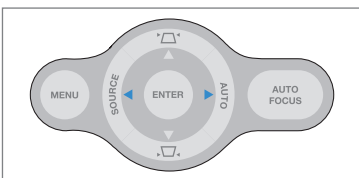

After the desired menu name has been selected, select the desired item name with the cursor buttons (▲▼).

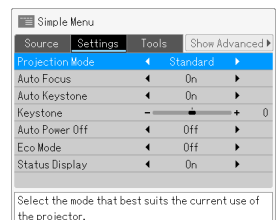
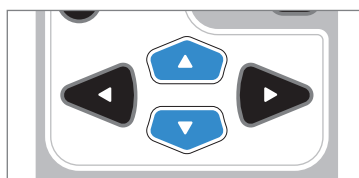
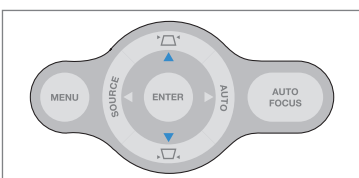



## List of Items Allowing Adjustment or Setting of Each Input Signal

The adjustment or setting that can be performed will differ depending on the input signal. See the table below for details.

### Simple Menu

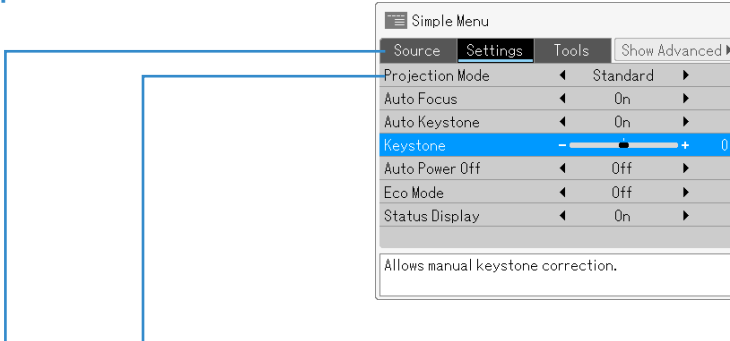

Menu Name	Item	COMPUTER IN		VIDEO IN	S-VIDEO IN	Page
		RGB Signal	Component Signal			
Source	Auto Detect	<input type="radio"/>	<input type="radio"/>	<input type="radio"/>	<input type="radio"/>	E-51
	Manual selection	Computer1	<input type="radio"/>	<input type="radio"/>	<input type="radio"/>	E-51
	Computer2	<input type="radio"/>	<input type="radio"/>	<input type="radio"/>	<input type="radio"/>	E-51
	Video	<input type="radio"/>	<input type="radio"/>	<input type="radio"/>	<input type="radio"/>	E-51
	S-Video	<input type="radio"/>	<input type="radio"/>	<input type="radio"/>	<input type="radio"/>	E-51
Settings	Projection Mode	<input type="radio"/>	<input type="radio"/>	<input type="radio"/>	<input type="radio"/>	E-52
	Auto Focus <small>KG-PS232Xh/232X only</small>	<input type="radio"/>	<input type="radio"/>	<input type="radio"/>	<input type="radio"/>	E-53
	Auto Keystone	<input type="radio"/>	<input type="radio"/>	<input type="radio"/>	<input type="radio"/>	E-53
	Keystone	<input type="radio"/>	<input type="radio"/>	<input type="radio"/>	<input type="radio"/>	E-54
	Auto Power Off	<input type="radio"/>	<input type="radio"/>	<input type="radio"/>	<input type="radio"/>	E-55
	Eco Mode <small>KG-PS232Xh/232X only</small>	<input type="radio"/>	<input type="radio"/>	<input type="radio"/>	<input type="radio"/>	E-56
	Status Display	<input type="radio"/>	<input type="radio"/>	<input type="radio"/>	<input type="radio"/>	E-56
Tools	Blank/Mute	<input type="radio"/>	<input type="radio"/>	<input type="radio"/>	<input type="radio"/>	E-57
	Still Image	<input type="radio"/>	<input type="radio"/>	<input type="radio"/>	<input type="radio"/>	E-57
	Zoom	<input type="radio"/>	<input type="radio"/>	<input type="radio"/>	<input type="radio"/>	E-58
	Timer Display	<input type="radio"/>	<input type="radio"/>	<input type="radio"/>	<input type="radio"/>	E-60
	Volume	<input type="radio"/>	<input type="radio"/>	<input type="radio"/>	<input type="radio"/>	E-61
	Select language	<input type="radio"/>	<input type="radio"/>	<input type="radio"/>	<input type="radio"/>	E-62

## Using the Menu

# List of Items Allowing Adjustment or Setting of Each Input Signal

The adjustment or setting that can be performed will differ depending on the input signal. See the table below for details.

### Advanced Menu

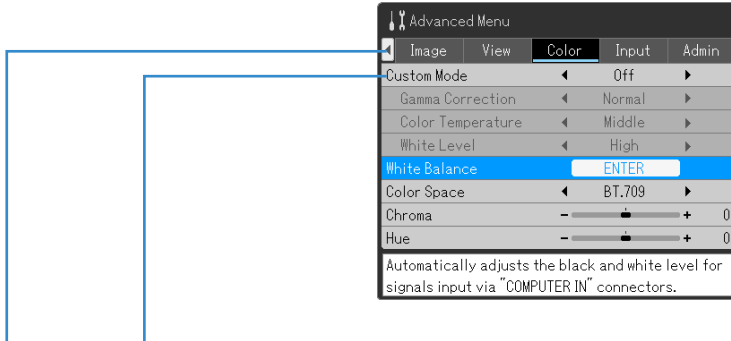

Menu Name	Item	COMPUTER IN		VIDEO IN	S-VIDEO IN	Page
		RGB Signal	Component Signal			
Image	Brightness	<input type="radio"/>	<input type="radio"/>	<input type="radio"/>	<input type="radio"/>	E-63
	Contrast	<input type="radio"/>	<input type="radio"/>	<input type="radio"/>	<input type="radio"/>	E-63
	Sharpness			<input type="radio"/>	<input type="radio"/>	E-63
	Frequency Compensation	<input type="radio"/>				E-64
	Phase Control	<input type="radio"/>				E-65
	Definition	<input type="radio"/>	<input type="radio"/>			E-65
View	Select Aspect Ratio	<input type="radio"/>	<input type="radio"/>	<input type="radio"/>	<input type="radio"/>	E-66
	Horizontal Position	<input type="radio"/>				E-68
	Vertical Position	<input type="radio"/>				E-68
	Vertical Flip	<input type="radio"/>	<input type="radio"/>	<input type="radio"/>	<input type="radio"/>	E-68
	Horizontal Flip	<input type="radio"/>	<input type="radio"/>	<input type="radio"/>	<input type="radio"/>	E-68
Color	Custom Mode	<input type="radio"/>	<input type="radio"/>	<input type="radio"/>	<input type="radio"/>	E-69
	Gamma Correction	<input type="radio"/>	<input type="radio"/>	<input type="radio"/>	<input type="radio"/>	E-69
	Color Temperature	<input type="radio"/>	<input type="radio"/>	<input type="radio"/>	<input type="radio"/>	E-70
	White Level	<input type="radio"/>	<input type="radio"/>	<input type="radio"/>	<input type="radio"/>	E-70
	White Balance	<input type="radio"/>				E-71
	Color Space		<input type="radio"/>			E-72
	Chroma			<input type="radio"/>	<input type="radio"/>	E-72
	Hue		<input type="radio"/>	<input type="radio"/>	<input type="radio"/>	E-73
Input	Computer1	<input type="radio"/>	<input type="radio"/>	<input type="radio"/>	<input type="radio"/>	E-74
	Computer2	<input type="radio"/>	<input type="radio"/>	<input type="radio"/>	<input type="radio"/>	E-74
	Video	<input type="radio"/>	<input type="radio"/>	<input type="radio"/>	<input type="radio"/>	E-74
	S-Video	<input type="radio"/>	<input type="radio"/>	<input type="radio"/>	<input type="radio"/>	E-74
Admin	Set Password	<input type="radio"/>	<input type="radio"/>	<input type="radio"/>	<input type="radio"/>	E-75
	Lamp Timer Reset	<input type="radio"/>	<input type="radio"/>	<input type="radio"/>	<input type="radio"/>	E-80
	Initialize	<input type="radio"/>	<input type="radio"/>	<input type="radio"/>	<input type="radio"/>	E-81
	Startup Screen	<input type="radio"/>	<input type="radio"/>	<input type="radio"/>	<input type="radio"/>	E-81
	Background Color	<input type="radio"/>	<input type="radio"/>	<input type="radio"/>	<input type="radio"/>	E-82

## Simple Menu / Source

These operations serve to set **Auto Detect** to **On** or **Off**, and perform selection of the input signal that will be projected.



### Auto Detect

This switches Auto Detect to On or Off.

- Align the cursor with the **Auto Detect** item name and switch the function **On** or **Off** with the cursor buttons (◀▶).

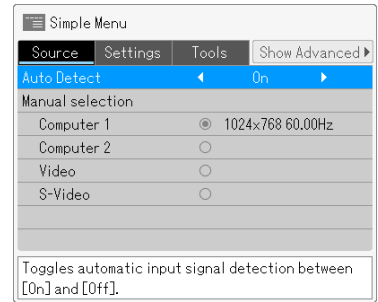
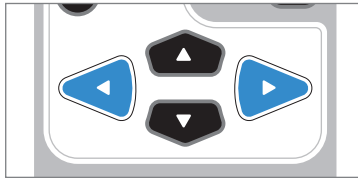
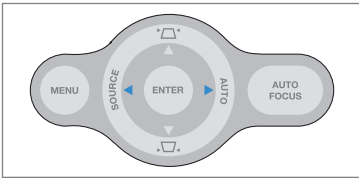

### Manual selection

This selects the input signal manually.

- Select the desired input source and press the ENTER button to finalize.

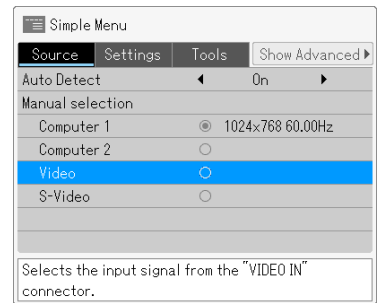
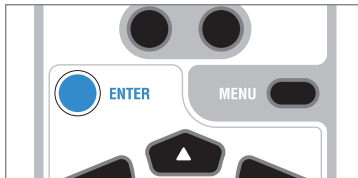
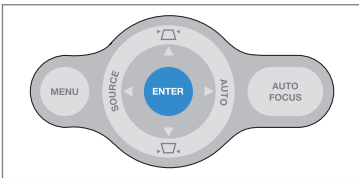

# Simple Menu / Settings

This performs simple settings when projecting images or video.



## Projection Mode

This projector has preset "Projection Modes" to suit the application.

- Align the cursor with the **Projection Mode** item name and select the desired projection mode with the cursor buttons (◀▶). (The hue of the projected images or video will switch to the set projection mode each time there is switching with the cursor buttons (◀▶)).

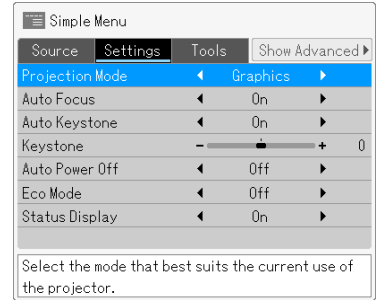
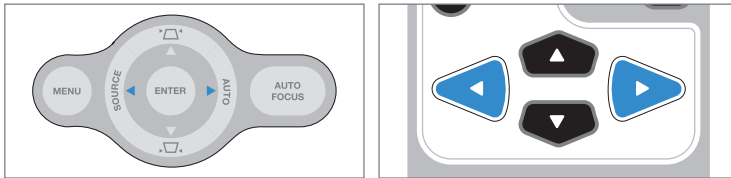

\*The Projection Mode that can be selected will differ depending on the input source. See the table below for details.

Input Source	Setting Item	Setting Content
<b>Computer 1/2</b> (RGB signal)	<b>Standard</b>	This is the standard setting.
	<b>Graphics</b>	A setting that prioritizes color reproducibility. Brightness will drop, but color reproducibility will rise. This is recommended for projection of photographs and animation.
	<b>Presentation</b>	A setting that prioritizes brightness. Color reproducibility will drop, but brightness will rise. This is recommended when projecting in a bright location.
	<b>Blackboard</b>	This is an optimum setting when projecting onto a blackboard.
	<b>Custom</b>	A setting that will apply the value that was set with <b>Color</b> under the <b>Advanced Menu</b> .
<b>Computer 1/2</b> (Component signal) <b>Video</b> <b>S-Video</b>	<b>Standard</b>	This is the standard setting.
	<b>Movie</b>	This is an optimum setting when projecting a movie.
	<b>Blackboard</b>	This is an optimum setting when projecting onto a blackboard.
	<b>Custom</b>	A setting that will apply the value that was set with <b>Color</b> under the <b>Advanced Menu</b> .

## Simple Menu / Settings

This performs simple settings when projecting images or video.

Source

Settings

Tools

### Auto Focus KG-PS232Xh/232X only

This sets the auto focus function On or Off.

- Align the cursor with the **Auto Focus** item name and switch the function **On** or **Off** with the cursor buttons (◀▶).

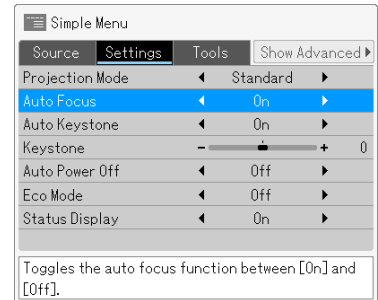
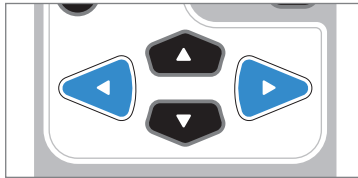
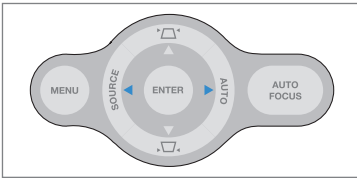

### Auto Keystone

This sets the auto keystone function On or Off.

- Align the cursor with the **Auto Keystone** item name and switch the function **On** or **Off** with the cursor buttons (◀▶).

**When the setting is On:** Keystone distortion in the vertical direction will be corrected automatically.

**When the setting is Off:** Automatic adjustment will not be performed. Correct the keystone distortion manually.

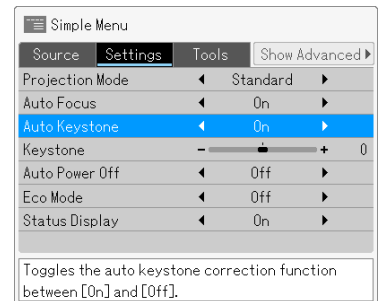
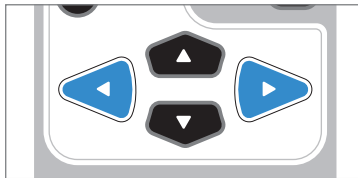
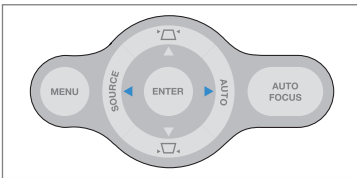

#### Technical Point

##### What is Keystone Distortion?

Keystone distortion is distortion of the projected image that occurs when the projector is tilted vertically or horizontally with respect to the screen.

There are two types of keystone distortion, in the horizontal direction when the projector is slanted to the left or right, and in the vertical direction when the projector is tilted up or down. This projector can manually or automatically correct the distortion in the vertical direction.

## Simple Menu / Settings

This performs simple settings when projecting images or video.

Source

Settings

Tools

### Keystone

Keystone distortion will occur when the angle of the projector is tilted (in the vertical direction) with respect to the screen. Keystone distortion can be corrected using this operation.

\* When **Auto Keystone** is **On**, keystone distortion in the vertical direction will be corrected automatically.

- Align the cursor with the **Keystone** item name and correct the keystone distortion with the cursor buttons (◀▶).

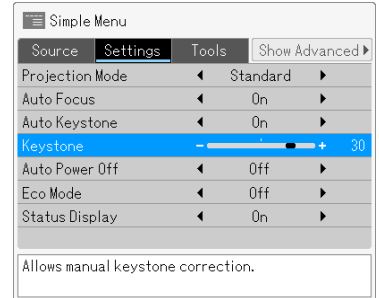
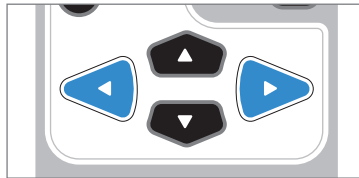
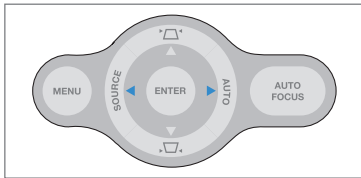
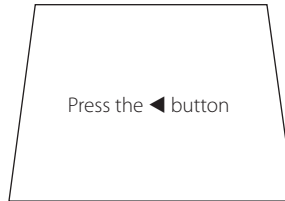
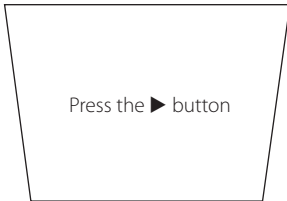

### Note

- The displayed menu screen itself will not be corrected.
- Please note that depending on the content and projection conditions of the projected images or video, the image might not be corrected sufficiently.
- When the **Auto Keystone** setting is **Off**, the adjustment value that was set with **Keystone** will be stored in the projector even after the power is turned off.

## Simple Menu / Settings

This performs simple settings when projecting images or video.

Source

Settings

Tools

### Auto Power Off

This function turns off the power of the projector automatically when the input source of the projector no longer has a signal.

The setting can be made from 5 minutes to 20 minutes in 5-minute portions.

- Align the cursor with the **Auto Power Off** item name and change the setting content with the cursor buttons (◀▶).
- Each press of the (▶) cursor button will change the setting one step in the sequence of **Off ▶ 5 min. ▶ 10 min. ▶ 15 min. ▶ 20 min.**. Adjust to the desired setting content.
- When **Auto Power Off** is set to an arbitrary number of minutes, the operation will be as described below.
  - When a no signal condition continues for approximately 10 minutes, "No Signal – Auto Power Off" will be displayed as shown below, and the power will be turned off when the set time passes.

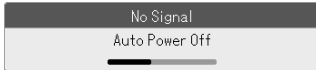

- The source input will be processed while the display appears; however, pressing an operation button other than the POWER/STANDBY button will close the display and cancel the function.

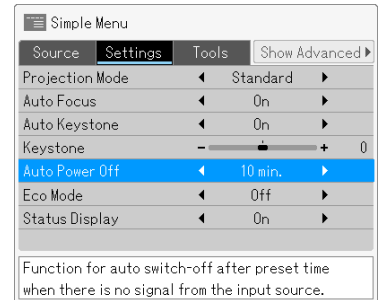
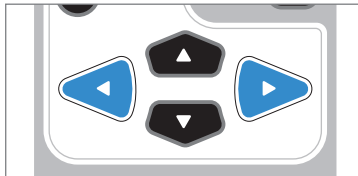
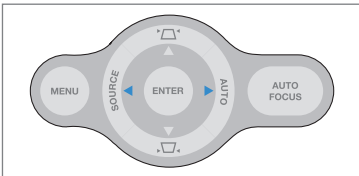

#### Note

Some video decks and other equipment will output a blue background or other video from the video deck side when playback is completed. Under this condition, there will be a signal input to the projector and thus **Auto Power Off** will not operate.

## Simple Menu / Settings

This performs simple settings when projecting images or video.

Source

**Settings**

Tools

### Eco Mode KG-PS232Xh/232X only

This function can limit the power consumption of the projector to permit the lamp to be used longer. By limiting the power consumption, the brightness will drop; however, the service life of the lamp will be longer than with normal use. This function can be used effectively for example when the screen is too bright when projecting onto a small screen, or when the brightness drops when projecting an image or video in a dark room.

- Align the cursor with the **Eco Mode** item name and switch the function **On** or **Off** with the cursor buttons (◀▶).

\* Please note that frequent switching of the Eco mode during image projection will cause deterioration of the lamp.

**On:** POWER/STANDBY button indicator flashes slowly in green. The brightness of the lamp will be approximately 80% of normal, and the service life of the lamp will be extended.

**Off:** POWER/STANDBY button indicator lights steadily in blue. The brightness of the lamp will be 100%, and there will be bright video.

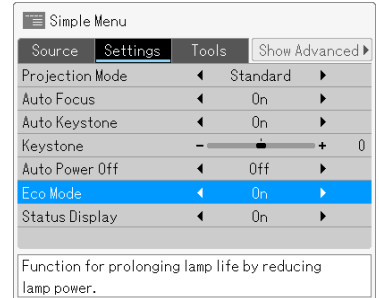
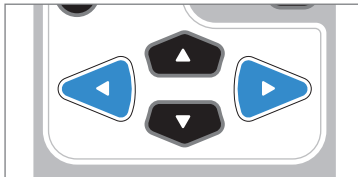
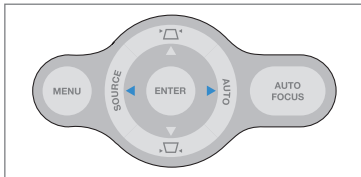

### Status Display

This function can set On or Off the message displays that appear when the projector is operated during projection, or at the time of source input detection.

- Align the cursor with the **Status Display** item name and switch the function **On** or **Off** with the cursor buttons (◀▶).

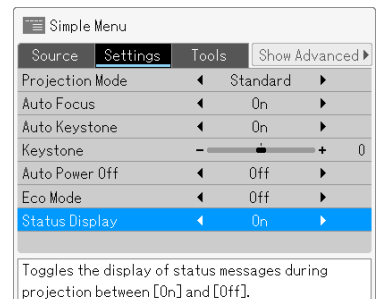
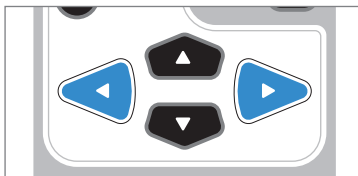
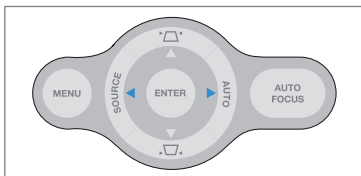

#### ! Note

Warnings and Power Off checks will be displayed even when the **Status Display** is set to **Off**.



## Simple Menu / Tools

Useful functions for projection of images and video.

Source

Settings

Tools

### Blank/Mute

Use this function when you would like to temporarily blank/mute the video and audio.

- Align the cursor with the **Blank/Mute** item name and press the ENTER button.
- A press of the ENTER button will activate the **Blank/Mute** function and this will blank the projected images or video and close the menu display.
- To project the image or video again, press a button with the exception of the POWER/STANDBY button.

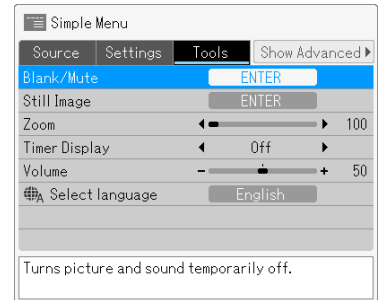
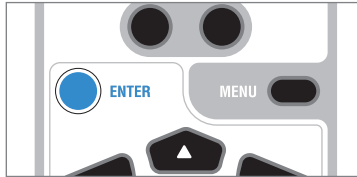
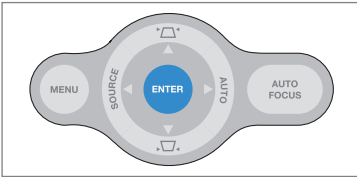

### Technical Point

Closing the lens shutter of the projector will automatically turn On the **Blank/Mute** function. This is a convenient function when you do not have a remote control handy, or you would like to temporarily blank the video.

### Still Image

Use this function when you would like to temporarily freeze the video.

This is a convenient function that allows a movie to be stopped, or a screen to be stopped during projection to permit searching for another document.

- Align the cursor with the **Still Image** item name and press the ENTER button.
- A press of the ENTER button will activate the **Still Image** function and this will temporarily stop the projected images or video and close the menu screen.
- To cancel **Still Image**, a button with the exception of the POWER/STANDBY button.

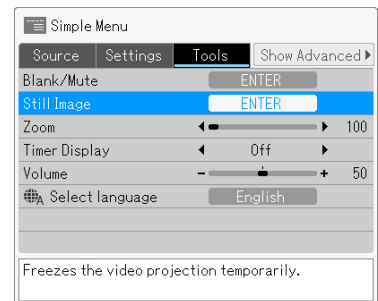
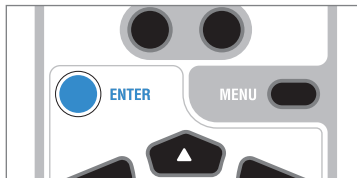
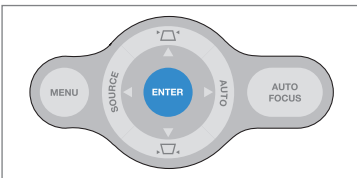

# Simple Menu / Tools

Useful functions for projection of images and video.

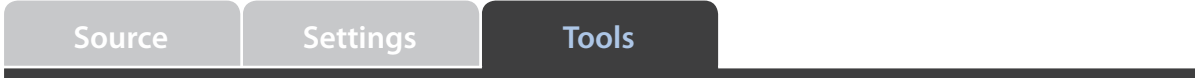

## Zoom

This function digitally enlarges projected images and video.

- Align the cursor with the **Zoom** item name and enlarge or reduce the image with the cursor buttons (◀▶).

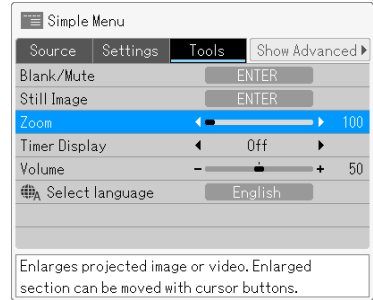

Each press of ▶ will further enlarge the video. (Up to 200%)

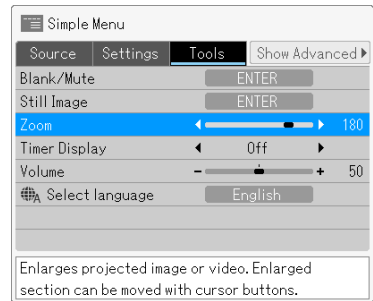
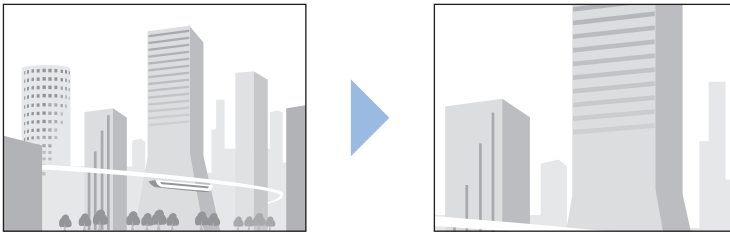

Each press of ◀ will return the video to its original state. (To 100%)

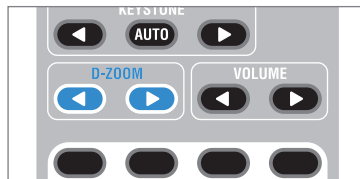
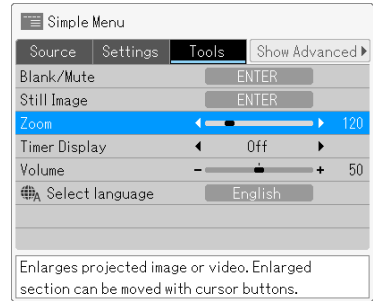
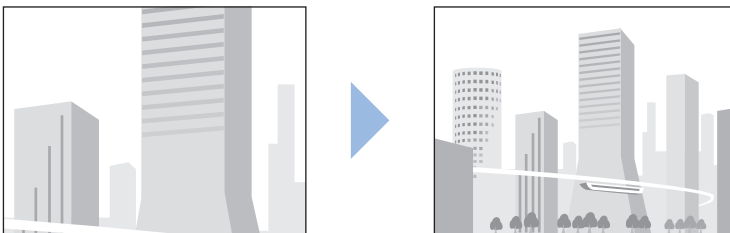

## Simple Menu / Tools

Useful functions for projection of images and video.

Source

Settings

Tools

- When the image has been enlarged to the desired size, press the ENTER button and delete the menu screen.
  - Pressing the cursor buttons (▲▼◀▶) of the remote control will result in movement of the display position.
- \* When enlargement has not been applied (i.e., Zoom is 100%), there will not be any movement.

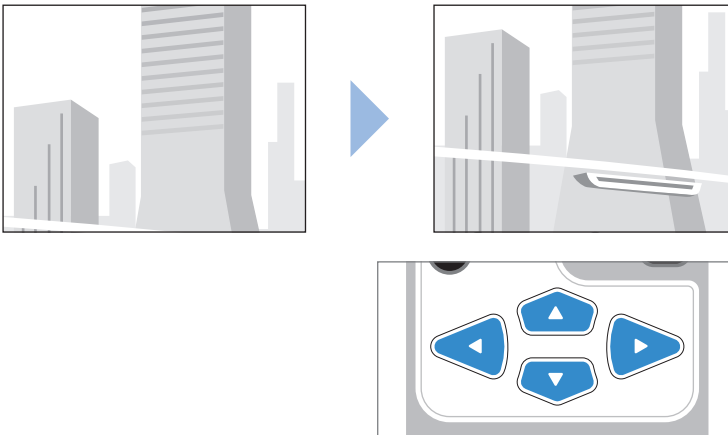

- To close the display right away, press the MENU button of the remote control or the projector. The display will close automatically when there has not been an operation in about 10 seconds.
- \* When finished with the enlargement operation, be sure to return the value of **Zoom** to **100**.

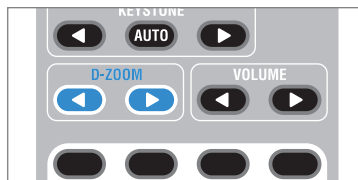

Zoom : 120

Zoom ◀────────────────▶ 100

 Note

The zoom condition will not be stored. The zoom condition will be cancelled automatically upon turning off the power or interrupting the input signal.

# Simple Menu / Tools

Useful functions for projection of images and video.

Source

Settings

Tools

## Timer Display

This function can provide a timer display on the screen for the timing of presentations.

By displaying a timer on the projection screen, the remaining time can be checked in an instant while giving the presentation.

- Align the cursor with the **Timer Display** item name and make the time setting with the cursor buttons (◀▶).
- Each press of the (▶) cursor button will change the set time one step in the sequence of **Off ▶ 10 min. ▶ 20 min. ▶ 30 min. ▶ 40 min. ▶ 50 min. ▶ 60 min.**
- When the MENU button is pressed to adjust the desired number of minutes, the menu display will disappear and the timer gauge will be displayed as illustrated below.

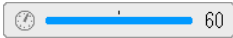

The remaining time is indicated with the black gauge and the timer. When the gauge disappears, the set time will have passed. (The timer will continue to be displayed after the gauge has disappeared.)

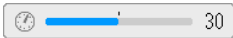

- When starting the timer again after the set time has elapsed, pressing the ENTER button will start the timer for the time that been set again.
- To delete the timer, press the MENU button, align the cursor with the **Timer Display** item name, and select **Off** with the cursor buttons (◀▶). The timer gauge will disappear.

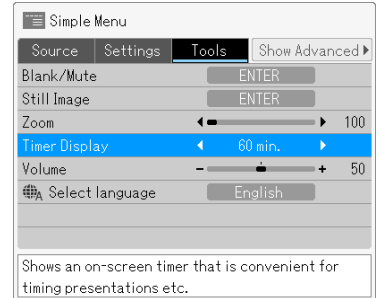
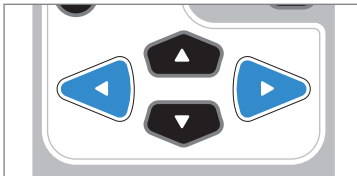
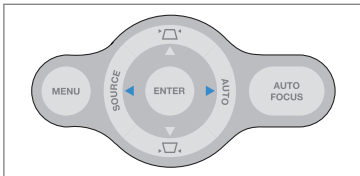

### Note

- The timer time will not be stored. The timer will automatically enter the Off state upon turning off the power.
- The timer gauge will disappear while the menu is displayed, or while a message is displayed, but the timer will be operating. The timer gauge will not be displayed unless a signal is being input.

## Simple Menu / Tools

Useful functions for projection of images and video.

Source

Settings

Tools

### To Move the Position of the Timer Gauge

Movement within the displayable range of the timer gauge is possible with the use of the cursor buttons (▲▼◀▶) of the remote control.

While the timer gauge is being displayed, use the cursor buttons (▲▼◀▶) to move the timer gauge to the desired position.

- The timer display can be used only when there is signal input. It cannot be used when there is no input signal.
- The screen movement that occurs when zoom is used cannot be performed during the display of the timer gauge.

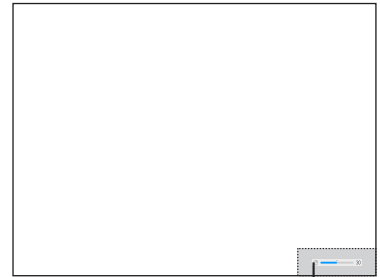
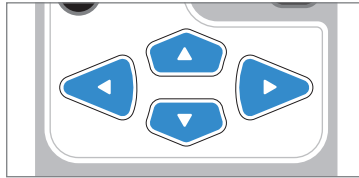

Range in which the timer display can be moved.

### Volume

This is the volume adjustment of the speaker that is built into the projector.

- Align the cursor with the **Volume** item name and adjust the volume with the cursor buttons (◀▶).

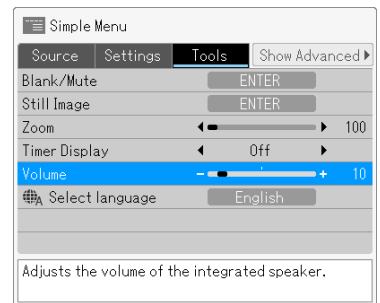
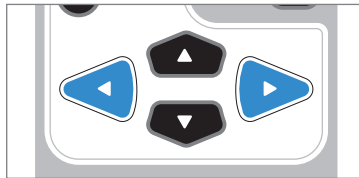
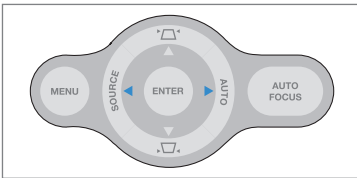

## Simple Menu / Tools

Useful functions for projection of images and video.

Source

Settings

Tools

### Select Language

This sets the language that is displayed in the menu displays and in the various message displays, etc.

- Align the cursor with the **Select Language** item name and press the ENTER button.

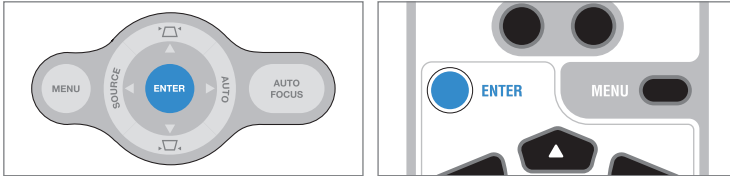

- The selection screen of display languages will be displayed. Select the desired language with the cursor buttons (▲▼) and press the ENTER button.

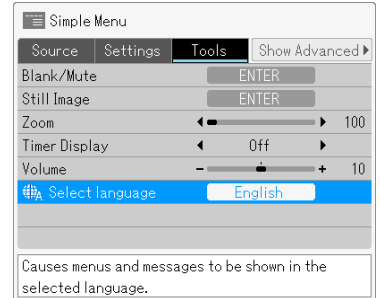
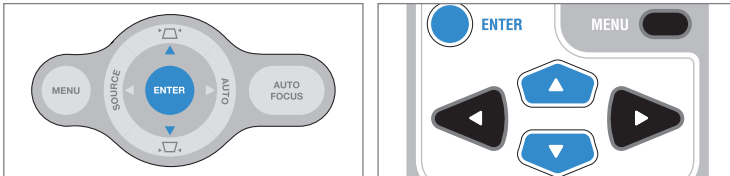

## Advanced Menu / Image

This permits fine video settings to be made. (Operate while the image that you would like to adjust or set is being projected.)



### Brightness / Contrast / Sharpness

These functions allow various video adjustments to be made in conjunction with the projected environment.

- Align the cursor with the various item names and adjust with the cursor buttons (◀▶).

Item Name	◀	▶
<b>Brightness</b>	Darker	Lighter
<b>Contrast</b>	Image becomes less dense	Image becomes more dense
<b>Sharpness</b>	Image becomes softer	Image becomes more distinct

\* **Sharpness** can be used only with **Video/S-Video** input.

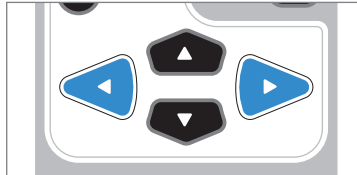
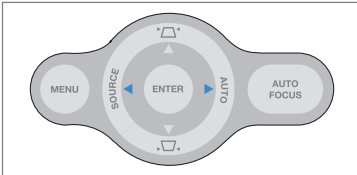
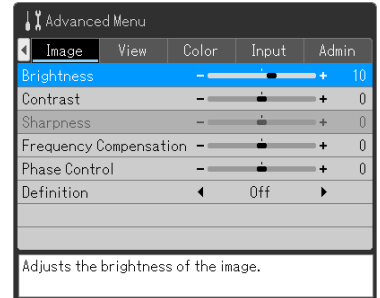

## Advanced Menu / Image

This permits fine video settings to be made. (Operate while the image that you would like to adjust or set is being projected.)



### Frequency Compensation

This performs an adjustment when light and dark vertical bands appear on the screen. Usually, an automatic adjustment is performed at the time of source input detection; however, when automatic adjustment is not satisfactory, please adjust as described below.

- Align the cursor with the **Frequency Compensation** item name and adjust with the cursor buttons (◀▶).
- While viewing the screen, set the adjustment value at which the brightness becomes uniform.

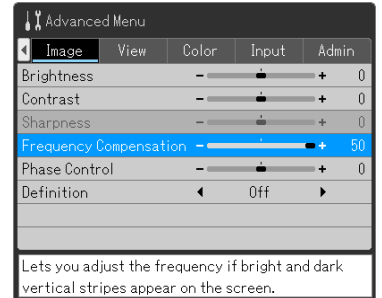
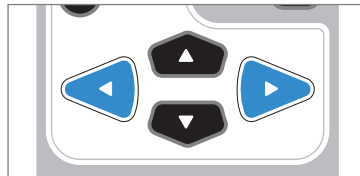
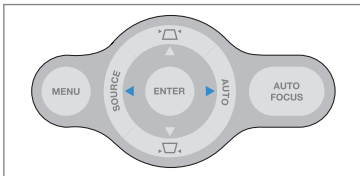
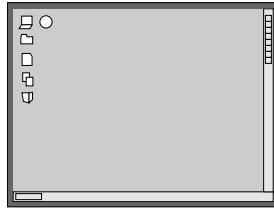
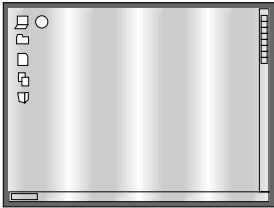

**Note**

**Frequency Compensation** is performed only at the time of RGB signal input.



## Advanced Menu / Image

This permits fine video settings to be made. (Operate while the image that you would like to adjust or set is being projected.)

Image

View

Color

Input

Admin

### Phase Control

This performs an adjustment when there is a screen color shift or flicker. Usually, an automatic adjustment is performed at the time of source input detection; however, when automatic adjustment is not satisfactory, please adjust as described below.

- Align the cursor with the **Phase Control** item name and adjust with the cursor buttons (◀▶).
- While viewing the screen, adjust so that the color shift or flicker no longer stands out.

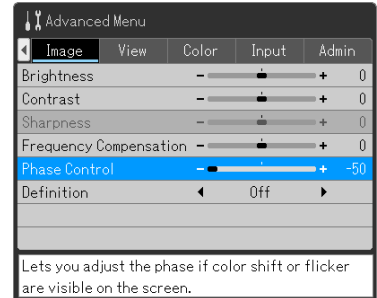
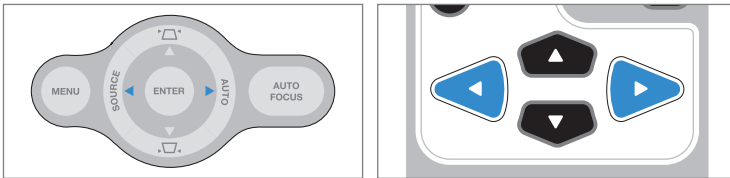
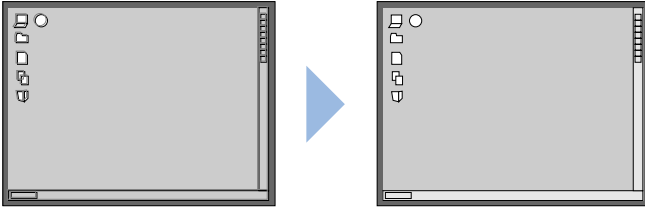

### Technical Point

#### What is phase?

Phase indicates the timing of the video signal. When a shift occurs in the timing of the video signal between the equipment that outputs the video and the projector, a color shift or flicker will be produced. By adjusting the timing with **Phase Control** in the projector, proper video can be projected.

### Definition

This adjusts the definition when an input signal is adjusted to the resolution of this projector and an enlarged or reduced display is produced.

- Align the cursor with the **Definition** item name and adjust with the cursor buttons (◀▶).
- Setting **Definition** to **Off** will result in a soft image, and moire patterns and other effects will no longer stand out. On the other hand, setting **Definition** to **On** will result in a sharp image, and fine lines will appear distinct.

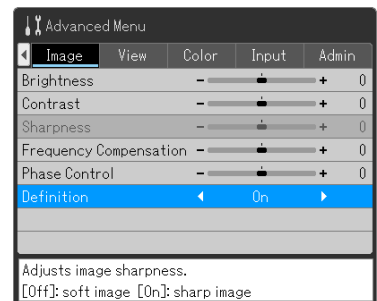
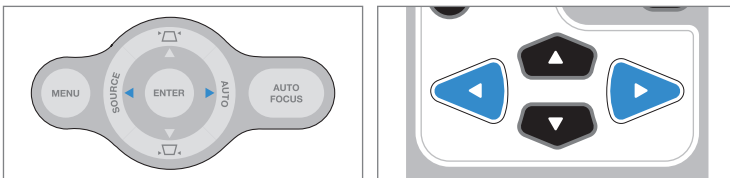

# Advanced Menu / View

This permits fine video settings to be made. (Operate while the image that you would like to adjust or set is being projected.)



## Select Aspect Ratio

This sets the aspect ratio of the input image.

- Align the cursor with the **Select Aspect Ratio** item name and adjust with the cursor buttons (◀▶).

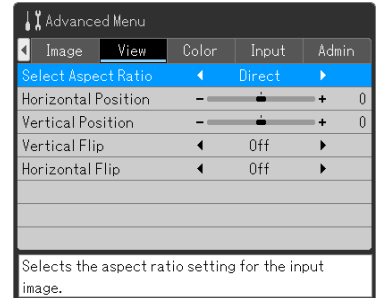
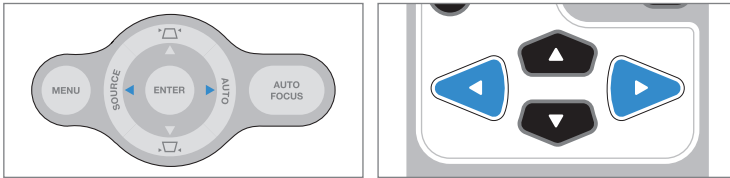

## For Computer Input

**Auto:** Automatically enlarges or reduces the input signal to a 4:3 screen, and projects to fill the screen.

**Direct:** Projects the image at the maximum displayable size while maintaining the aspect ratio of the input signal.

**Real:** Projects the input signal without converting the pixels.

Input Signal	Auto	Direct	Real
When higher than the display resolution of the projector			
When lower than the display resolution of the projector			

## Advanced Menu / View

This permits fine video settings to be made. (Operate while the image that you would like to adjust or set is being projected.)









### For Video Signals and Component Signals

**Auto:** Project to fill the screen so that no portion protrudes from the screen while maintaining the aspect ratio. (The top and bottom of a 16:9 video will be black.)

**Wide:** Project all to fill the screen width in a 16:9 screen. This is used to project a squeezed screen at the proper aspect ratio.

**Zoom:** Projects so as to fill the screen at 16:9, or only the 4:3 portion inside letterbox. (The protruding portion will be cut.)

Select Aspect Ratio	Auto	Wide	Zoom
4:3 Screen			
16:9 Screen			

## Advanced Menu / View

This permits fine video settings to be made. (Operate while the image that you would like to adjust or set is being projected.)



### Horizontal Position / Vertical Position

Adjusts the position when the screen picture is shifted vertically or horizontally. Usually, an automatic adjustment is performed at the time of source input detection; however, when automatic adjustment is not satisfactory, please adjust as described below.

- Align the cursor with the **Horizontal Position**, or **Vertical Position** item name and adjust with the cursor buttons (◀▶).

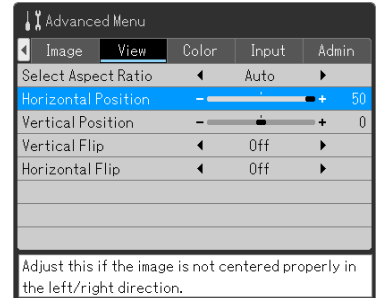
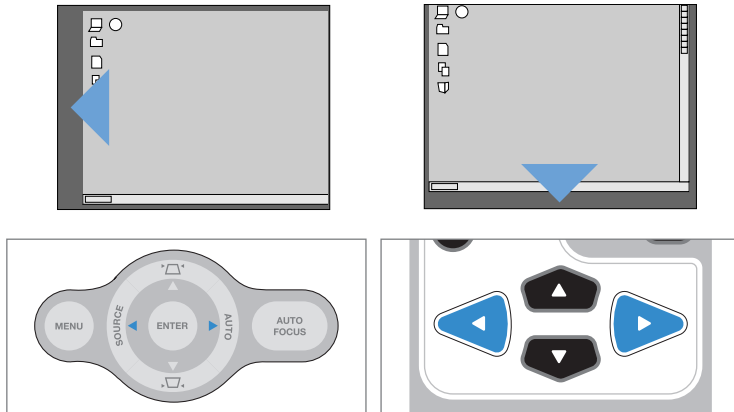

### Vertical Flip / Horizontal Flip

Use this when the projector is installed suspended from the ceiling, or is in a rear projection setup.

- Align the cursor with the **Vertical Flip**, or **Horizontal Flip** item name and make the setting with the cursor buttons (◀▶).

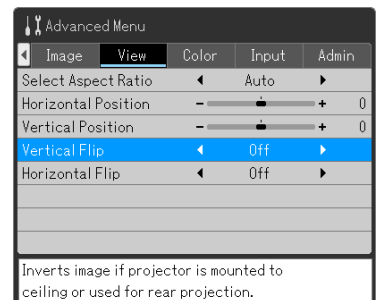
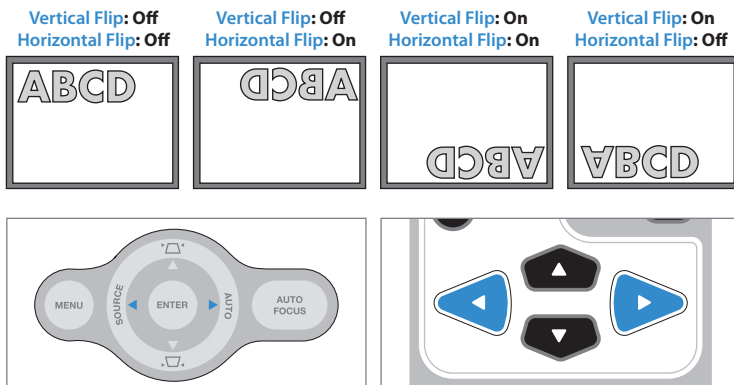

## Advanced Menu / Color

This permits fine video settings to be made. (Operate while the image that you would like to adjust or set is being projected.)



### Custom Mode

This can set an original projection mode different from the preset projection modes.

- Align the cursor with the **Custom Mode** item name and switch the function **On** or **Off** with the cursor buttons (◀▶).
- \* When **Custom Mode** is set to **On**, **Custom** will be selected for **Projection Mode**. When **Custom Mode** is set to **Off**, **Standard** will be selected for **Projection Mode**.
- Only when the setting is **On**, **Custom Mode** can be adjusted using **Gamma Correction**, **Color Temperature**, and **White Level**. When the setting is **Off**, the item name will be displayed in gray, and selection and adjustment will not be possible.

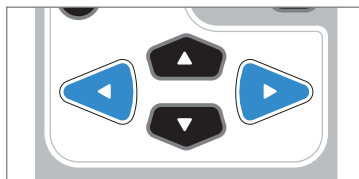
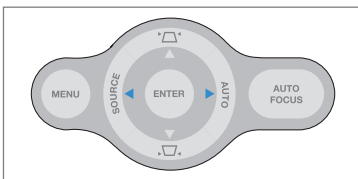
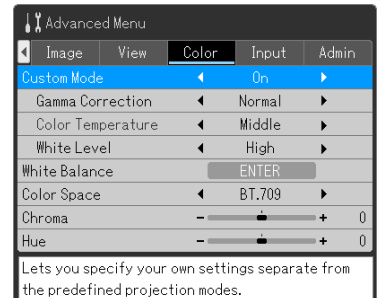

### Gamma Correction

This corrects the proportion of the change of the dark portion from the bright portion of the input signal.

This is used when reproducing natural color tones, and when projecting personal computer images distinctly in a bright meeting room, etc.

- Align the cursor with the **Gamma Correction** item name and select the setting content with the cursor buttons (◀▶).

**Normal:** Performs a standard correction.

**Natural:** Corrects so as to result in a natural color tone.

**Real:** Performs a correction with emphasis on brightness.

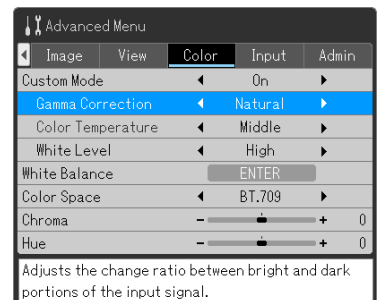

**Note**

When **Off** is set in **Custom Mode**, the **Gamma Correction**, **Color Temperature**, and **White Level** items will be displayed in gray, and selection and adjustment will not be possible.

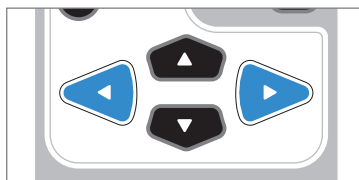
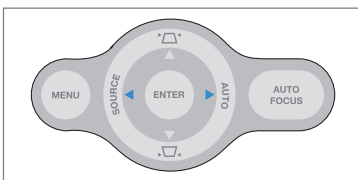

## Advanced Menu / Color

This permits fine video settings to be made. (Operate while the image that you would like to adjust or set is being projected.)



### Color Temperature

The screen is affected by illumination and other colors of external light. This function adjusts the white color which is the basic color of the video equipment, and raises the reproducibility of the color.

It can also produce video with importance given to skin tones.

- Align the cursor with the **Color Temperature** item name and select the setting content with the cursor buttons (◀▶).

**Low:** Creates a warm white. (Reddish tone)

**Middle:** Creates a warm white. (Yellowish tone)

**Recommended:** Creates the white of sunlight.

**High:** Creates a cool white. (Bluish tone)

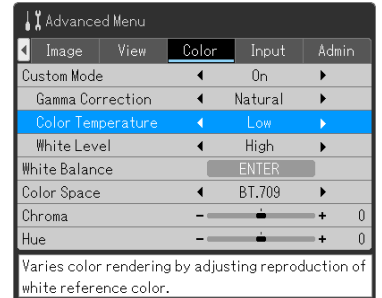
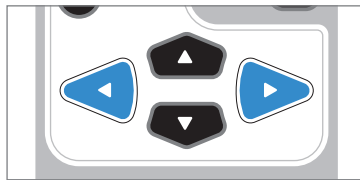
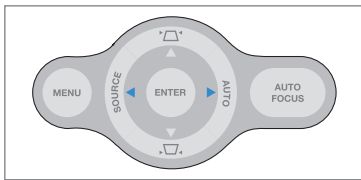

#### Note

When Off is set in Custom Mode, the Gamma Correction, Color Temperature, and White Level items will be displayed in gray, and selection and adjustment will not be possible.

### White Level

This can project text or diagrams from a personal computer and emphasize the white.

- Align the cursor with the **White Level** item name and select the setting content with the cursor buttons (◀▶).
- Select the desired white level from among **Low**, **Middle**, and **High**.

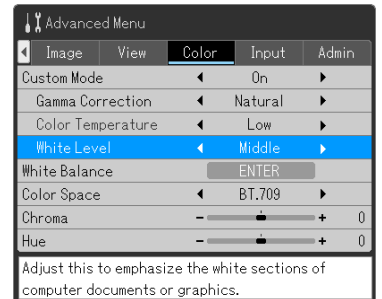
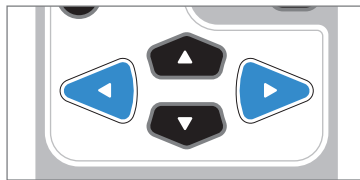
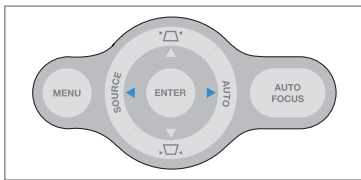

#### Note

When Off is set in Custom Mode, the Gamma Correction, Color Temperature, and White Level items will be displayed in gray, and selection and adjustment will not be possible.

## Advanced Menu / Color

This permits fine video settings to be made. (Operate while the image that you would like to adjust or set is being projected.)



### White Balance

This function automatically adjusts the black and white level of the signal that was input from COMPUTER IN 1/2 so that it suits the personal computer. This adjustment raises the reproducibility of the color.

1. Align the cursor with the **White Balance** item name and press the ENTER button. This message will be displayed: Input black signal from "COMPUTER IN 1" and press "ENTER".
2. Set the connected personal computer screen to black.
3. A press of the ENTER button will display the "Adjusting black" message, and the black level will be adjusted.

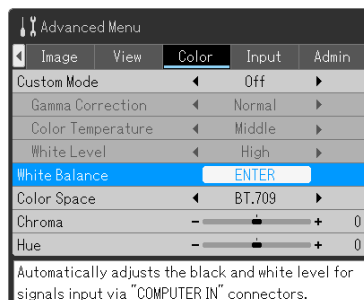

4. When the adjustment of the black level is completed, this message will be displayed: Input white signal from "COMPUTER IN 1" and press "ENTER".
5. Set the connected personal computer screen to white.
6. A press of the ENTER button will display the "Adjusting white" message, and the white level will be adjusted.



The "White balance adjustment completed" message will be displayed for a while and the adjustment will be completed.

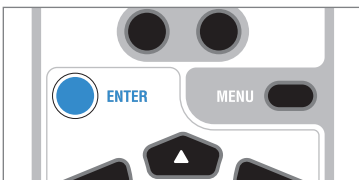
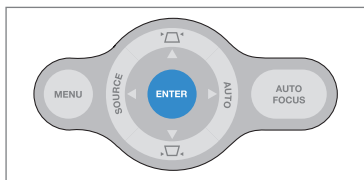

### Technical Point

#### How to set the personal computer screen to black or white?

By using Microsoft Office PowerPoint the screen can easily display white or black. Start any PowerPoint file and run a slideshow display. Press "W" on the keyboard during the slideshow display and the screen will become white. (Press another key and the screen will return to the original condition.) Similarly, pressing "B" on the keyboard will result in the screen turning black.

# Advanced Menu / Color

This permits fine video settings to be made. (Operate while the image that you would like to adjust or set is being projected.)



## Color Space

This function can adjust the color tone when the image is projected with a reddish or greenish quality at the time of a component signal input.

- Align the cursor with the **Color Space** item name and use the cursor buttons (◀▶) to select a Color Space that will result in a normal image.
- There are two types of selection content: **BT.709**, and **SMPTE240**.

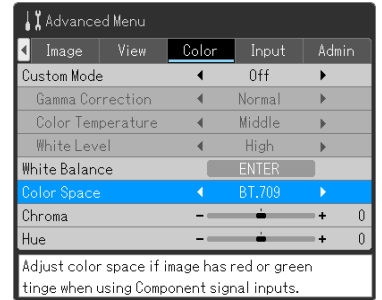
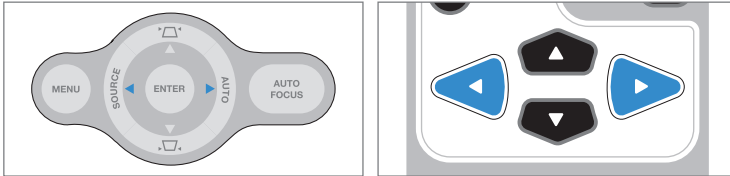

### Note

- When the component signal is undergoing conversion processing to RGB, which is the video expression of the projector, the correct colors cannot be expressed unless a system is used that is compatible with the color-difference conversion system of the input signal. **Color Space** serves to select the system.
- Only HDTV/SDTV can adjust **Color Space**.

## Chroma

This function can adjust the chroma of the projected image.

- Align the cursor with the **Chroma** item name and adjust with the cursor buttons (◀▶).
- ◀: Color becomes less dense
- ▶: Color becomes more dense
- \* **Chroma** can be used only with **Video/S-Video** input.

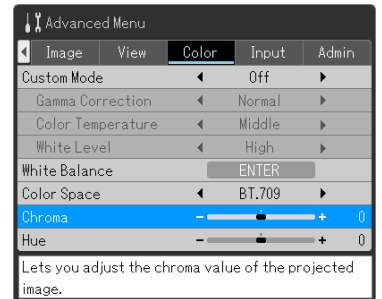
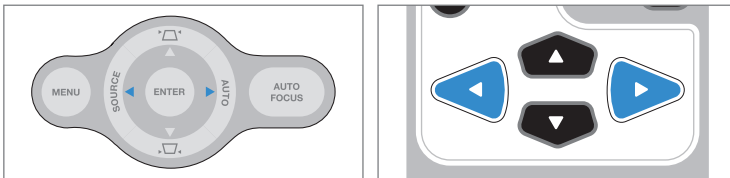



## Advanced Menu / Color

This permits fine video settings to be made. (Operate while the image that you would like to adjust or set is being projected.)



### Hue

This function can adjust the hue of the projected image.

- Align the cursor with the **Hue** item name and adjust with the cursor buttons (◀▶).

◀: Reddish

▶: Greenish

\* **Hue** can be used only with component signal/**Video/S-Video** input.

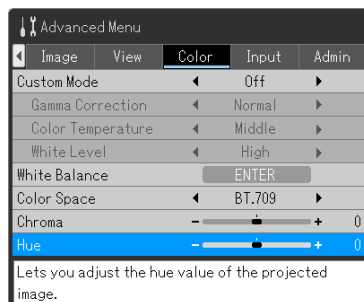
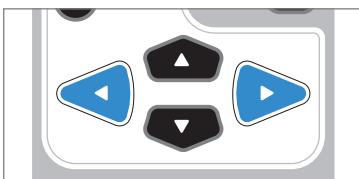
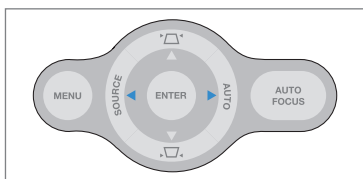

# Advanced Menu / Input

This function is used in setting the input signals of the input connectors.



Usually, this should be set to **Auto**. See Page E-51.

Only when identification is not possible with **Auto**, should the **Input** setting be made.

- Align the cursor with one of the various item names and make the setting with the cursor buttons (◀▶).

Input Signal	Selection Item	Selection Content
<b>Computer1/2</b>	<b>Auto</b>	Automatically detects the signal.
	<b>Computer</b>	Fixed to the analog RGB signal.
	<b>Component</b>	Fixed to the component signal.
<b>Video/S-Video</b>	<b>Auto</b>	Automatically detects the signal.
	<b>NTSC</b>	Fixed to the NTSC system.
	<b>PAL</b>	Fixed to the PAL system.
	<b>SECAM</b>	Fixed to the SECAM system.
	<b>NTSC 4.43</b>	Fixed to the NTSC 4.43 system.
	<b>PAL M</b>	Fixed to the PAL M system.
	<b>PAL N</b>	Fixed to the PAL N system.
	<b>PAL 60</b>	Fixed to the PAL 60 system.

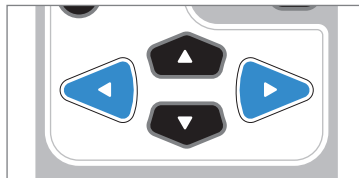
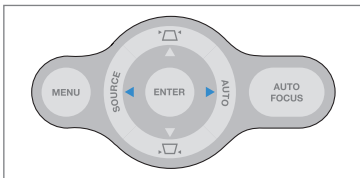
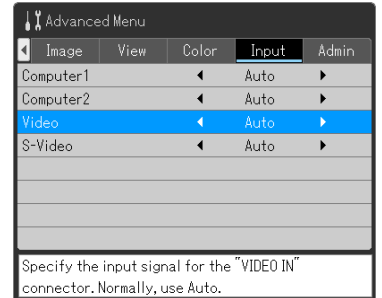

## Advanced Menu / Admin

This function can be used to make a security password setting or perform a check/reset of the lamp timer, etc.

Image

View

Color

Input

Admin

### Set Password

A password can be set to restrict startup to avoid tampering with the projector or unauthorized use.

- Align the cursor with the **Set Password** item name and set the setting content to **On** with the cursor buttons (◀▶). The menu screen will disappear and the password setting screen will be displayed.

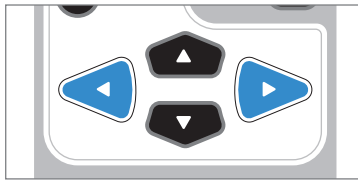
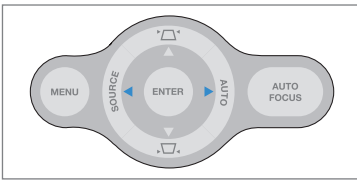
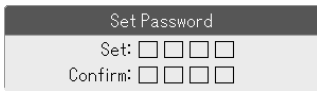

- Make the setting using the cursor buttons (▲▼◀▶) of the remote control or the projector control panel. Be sure to enter 4 digits.

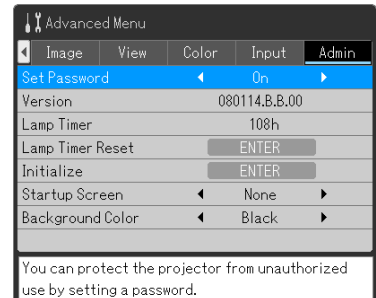
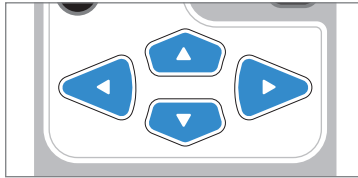
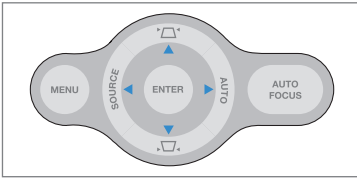

#### Note

The password that has been entered will not be displayed; therefore, be sure to make a memo of the set content and keep it where you will be able to find it.

\* Use the supplied security sheet and security labels.

Continued on next page →

## Advanced Menu / Admin

This function can be used to make a security password setting or perform a check/reset of the lamp timer, etc.



### Example: Set password ◀▼▼▲

1. A press of cursor button "◀" will result in an asterisk "\*" being placed in the first digit space. Continue by pressing the "▼" "▼" "▲" cursor buttons and asterisks "\*" will be placed in all 4 digit spaces.



2. When the password setting entry has been completed, the check entry will continue. Again, entering "◀" "▼" "▼" "▲" will place "\*" in the 4 digits of the check entry.



When the password is incorrect at the time of the check entry, a message will be displayed and the "\*" will disappear. Repeat the procedure again from the setting entry.

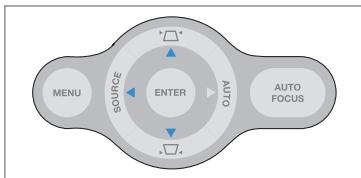
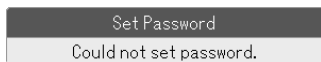

\* To delete the setting at the time of password entry, press the MENU button. The asterisks "\*" will disappear and the system will return to wait for the setting entry. To quit the password setting, press the MENU button one more time. The password setting screen will disappear and the menu screen will be displayed.

This completes the password setting. The next time the power is turned on, the password entry screen will be displayed.

This function can be used to make a security password setting or perform a check/reset of the lamp timer, etc.

Image

View

Color

Input

Admin

### When the Power Is Turned On, “Please enter the password.” Will Be Displayed

When performing **Set Password** and the power is turned on, the password entry screen will be displayed. This screen will continue to be displayed unless the password that was set is entered. In the next step, enter the password that has been set.

- Enter the password using the entry buttons (cursor buttons). Be sure to enter the 4 digits that have been set.

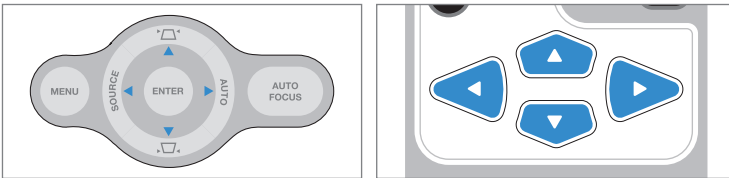

#### Example: Enter password ◀▼▼▲

A press of cursor button “◀” will result in an asterisk “\*” being placed in the first digit space.

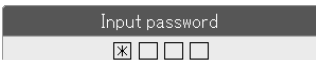

Continue by pressing the “▼” “▼” “▲” cursor buttons and asterisks “\*” will be placed in all 4 digit spaces. If the password matches, the display will disappear and the projector will enter a usable state.

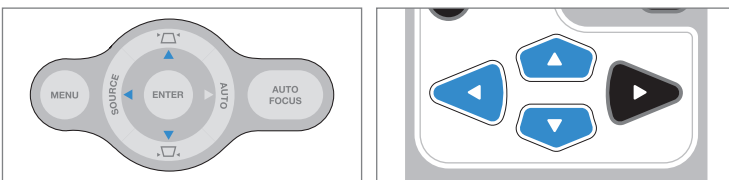

Continued on next page →

This function can be used to make a security password setting or perform a check/reset of the lamp timer, etc.



### Canceling a Password / Changing a Password

An operation with the menu is required to cancel or change a password.

#### Canceling a password

1. Align the cursor with the **Set Password** item name and set the setting content to **Off** with the cursor buttons (◀▶).
2. This will set **Set Password** to **Off**. The password entry display will not be displayed the next time the projector is started.

#### Changing a password

1. After **Set Password** has been set to **Off** with the aforementioned operation, we will set it to **On** again.
2. The menu screen will close and the password setting screen will be displayed.
3. Please set a new password. (For information about setting, see Page E-75.)

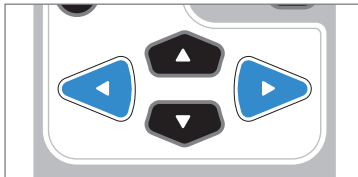
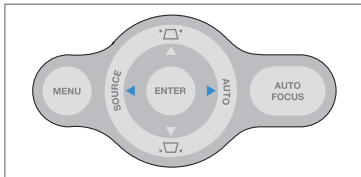

### Version

This displays the version information of the projector.

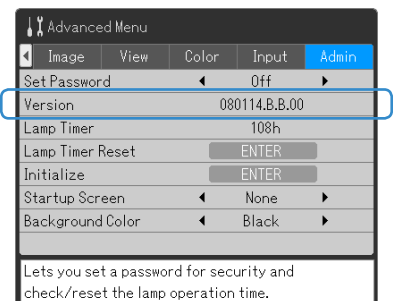

## Advanced Menu / Admin

This function can be used to make a security password setting or perform a check/reset of the lamp timer, etc.

Image

View

Color

Input

Admin

### Lamp Timer

This displays the usage time of the lamp. Model **KG-PS232Xh/232X** is equipped with an Eco Mode function. The service life of the lamp will differ in standard mode and Eco mode.

**When used only in standard mode:** Approximately 2,000 hours

**When used only in Eco mode:** Approximately 3,000 hours

- When both modes are used alternately, the lamp service life will fluctuate.
- Model **KG-PV131X/131S** does not have the Eco Mode function. It only has the standard mode, and the service life of the lamp will be 4,000 hours.

#### When the Lamp Has Reached the End of Its Service Life

"Replace the lamp cartridge." will be displayed on the screen for 10 seconds in 1 minute intervals. Replace the lamp with a new one. See "Replacing the Lamp Cartridge" for information about the lamp replacement method. See Pages E-87 and 88.

Replace the lamp cartridge.

#### When More than Hours Have Elapsed After Reaching the Lamp Service Life

"Turning power off – Replace the lamp cartridge." will be displayed on the screen for 10 seconds, then the power will be switched off by the projector. When this condition has been reached, even pressing the POWER/STANDBY button will not turn on the power. Replace the lamp with a new one.

Turning power off

Replace the lamp cartridge.

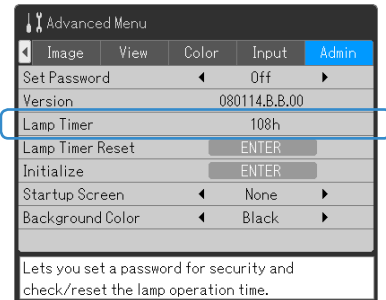

This function can be used to make a security password setting or perform a check/reset of the lamp timer, etc.



## Lamp Timer Reset

This resets the lamp timer. Be sure to perform the lamp timer reset operation when the lamp is replaced.

- Align the cursor with the **Lamp Timer Reset** item name and press the ENTER button. This message will be displayed on the screen: Resetting lamp operation time – Press "ENTER" to proceed. (Press "MENU" to cancel.)

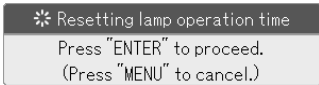

- Pressing the ENTER button again will return the lamp timer to **0**.
- \* To cancel **Lamp Timer Reset**, press the MENU button and there will be a return to the menu screen.

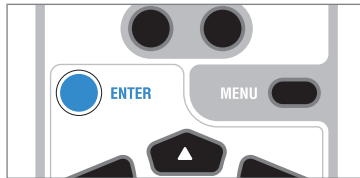
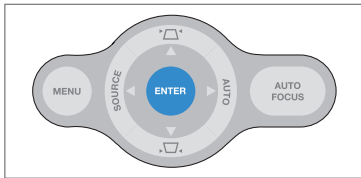
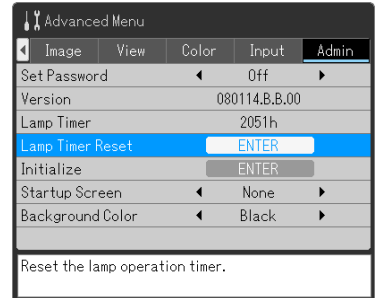



## Advanced Menu / Admin

This function can be used to make a security password setting or perform a check/reset of the lamp timer, etc.



### Initialize

This function returns to the standard value (default shipping setting) the content that has been set or adjusted with the various items.

- Align the cursor with the **Initialize** item name and press the ENTER button. This message will be displayed on the screen: Initializing – Press "ENTER" to proceed. (Press "MENU" to cancel.)

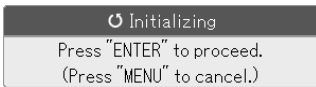

- Press the ENTER button again to initialize.
- \*To cancel **Initialize**, press the MENU button and there will be a return to the menu screen.
- Even when the following items are initialized, the settings will remain.

**Vertical Flip, Horizontal Flip, Language Setting, Lamp Timer, Set Password**

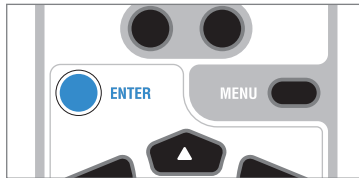
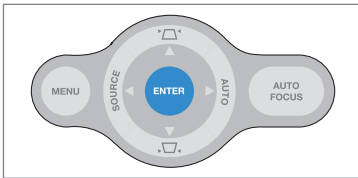
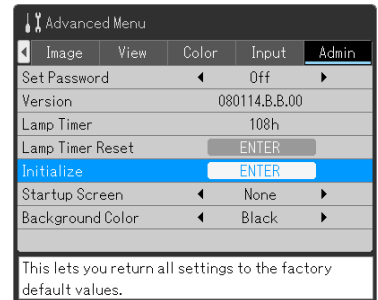

### Startup Screen

This switches the display/no display status of the logo screen that is displayed when the projector is starting.

- Align the cursor with the **Startup Screen** item name and switch between **Logo** and **None** with the cursor buttons (◀▶).

**Logo:** The logo (TAXAN) is displayed.

**None:** The logo is not displayed.

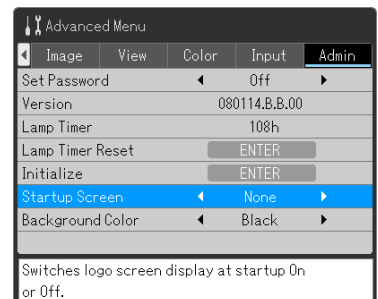
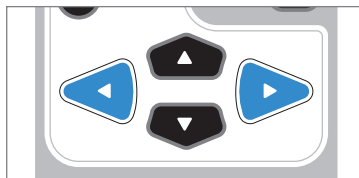
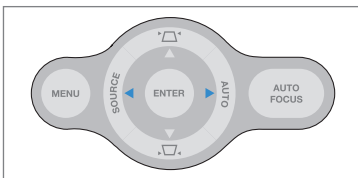

## Advanced Menu / Admin

This function can be used to make a security password setting or perform a check/reset of the lamp timer, etc.



### Background Color

This function can set the screen color when **Blank/Mute** or other operations are performed.

- Align the cursor with the **Background Color** item name and make the setting with the cursor buttons (◀▶).





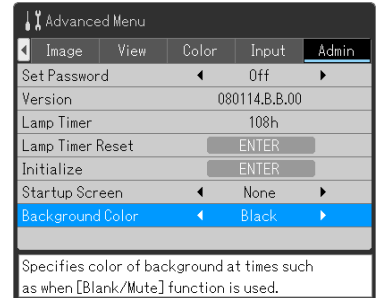
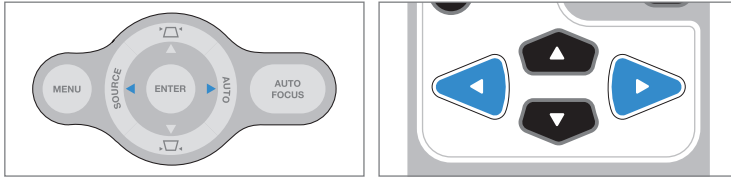







**Blue:** The background color will be a blue screen.

**Black:** The background color will be a black screen.



# When an indicator is lit or flashing

The LAMP/HEAT indicator will be lit or flashing to notify of problems as described in the table below.

Indicator Status			Details of the Problem
POWER/STANDBY button	HEAT	LAMP	
		 LAMP Red: Lit	<b>It is time to replace the lamp.</b> Replace the lamp with a new one. See Page E-87.
 Red: Flashing		 LAMP Red: Flashing	<b>The lamp has reached the end of its service life. The power will no longer turn on.</b> The lamp has been used for more than 100 hours after reaching its service life. Replace the lamp with a new one. See Page E-87.
 Red: Lit		 LAMP Red: Flashing	<b>The lamp cover is open.</b> The lamp cover is not attached properly. Attach it properly. See Pages E-88 and 89.
 Red: Lit		 LAMP Red: Lit	<b>The lamp will not light.</b> Wait at least 90 seconds, then turn the power on again. If the problem persists, unplug the power cable and contact the dealer or a TAXAN customer service center.
 Red: Lit	 HEAT Red: Lit		<b>The temperature is abnormally high.</b> <ul style="list-style-type: none"> <li>The thermal protector is activated. When the room temperature is high, move the projector to a cool place. When the internal temperature of the projector is high, check the cooling fan ventilation holes. If clogged, clean the filter.</li> <li>When the temperature protector is activated, the power will turn off, and it might not come back on even when the power is turned on immediately. In this case, wait about 90 seconds, then turn the power back on again.</li> </ul>
 Red: Flashing	 HEAT Red: Flashing	 LAMP Red: Flashing	<b>Other Hardware Faults</b> Unplug the power cable, and request repair service from a dealer or a TAXAN customer service center.

When the indicator is lit/flashes when the projector is in a normal condition, or in a condition other than described above, unplug the power cable and contact the dealer or a TAXAN customer service center.

### Thermal Protector

If the internal temperature of the projector becomes abnormally high, the thermal protector will be activated and will turn off the power of the projector.

If this occurs, please take the following actions.

- 1. Disconnect the power plug from the wall outlet.**
- 2. Check the following matters and take the required measures.**  
 When the projector is being used in a location having a high ambient temperature, set it up again in a cool place. Check the exhaust vents, and the ventilation slots. If clogged, clean them.
- 3. Wait about 60 minutes until the temperature of the projector drops.**

If after having performed the above matters, the problem persists, contact the dealer or a TAXAN customer service center.

# At a time such as this...

Check the following matters before requesting servicing.

Problem	Check	Reference Page
Power does not turn on	<ul style="list-style-type: none"> <li>Is the power cord plugged into a power outlet?</li> <li>Is the lamp cover properly mounted?</li> <li>Is the projector's temperature high? To protect the projector, the power cannot be turned on when the projector's temperature is abnormally high.</li> <li>Has the lamp reached the end of its service life?</li> <li>Depending on the timing of when the power cable is inserted (i.e., when the power is turned On), the indicator (LED) of the POWER/STANDBY button might not light and the power might not come on; however, this is not a breakdown of the projector. If this occurs, once again unplug the power cable and then insert it.</li> </ul>	<p>E-33 E-88, 89 E-83  E-83 —</p>
No image is produced	<ul style="list-style-type: none"> <li>Is a connected input selected?</li> <li>Is the cable properly connected to the input terminal?</li> <li>When a computer is connected, are signals being output from the computer?</li> <li>Does the signal being input have a frequency usable with this projector?</li> <li>Is the <b>Brightness</b> of the <b>Image</b>, or the <b>Contrast</b> set to the minimum?</li> <li>Is the LAMP/HEAT indicator red and lit steadily or flashing?</li> <li>When the component signal of a DVD player is connected to the COMPUTER IN 1/2 connector, and the video does not appear, is the <b>Input</b> of the COMPUTER IN 1/2 connector properly selected?</li> </ul>	<p>E-39 E-26–31 E-27 E-94 E-63 E-83 E-74</p>
Image is distorted	<ul style="list-style-type: none"> <li>Is the projector properly installed?</li> <li>For trapezoidal (keystone) distortion, perform keystone adjustment. Please note that depending on the projected picture and the projection conditions, it may not be possible to eliminate keystone distortion completely.</li> </ul>	<p>E-36 E-43, 53, 54</p>
Image is out of focus	<ul style="list-style-type: none"> <li>Is the lens properly focused?</li> <li>Are the screen and projector installed at the proper distance?</li> <li>Does the projection distance exceed the focusing range?</li> <li>Is there condensation on the lens, etc.? If the projector is moved from a cool storage area to a warm place and the power is turned on, condensation may form on the lens or internal optical parts. If this happens, wait until the condensation has evaporated before using the projector.</li> </ul>	<p>E-37 E-25 E-25 —</p>
Image is not in proper position and is not displayed properly	<ul style="list-style-type: none"> <li>In the case of <b>Computer 1/2</b> input, have the horizontal position and the vertical position been adjusted properly.</li> <li>Does the input signal have a compatible resolution and frequency? Check the computer's resolution.</li> </ul>	<p>E-68 E-94</p>
Video image is crushed	<ul style="list-style-type: none"> <li>If the image is crushed in the horizontal or vertical direction or if it is not displayed over the entire screen, select a different aspect ratio.</li> </ul>	<p>E-66</p>
Colors of the overall image are strange	<ul style="list-style-type: none"> <li>When a component signal is being input, is the color space setting proper?</li> <li>For composite input, is the adjustment of the color tone shifted?</li> </ul>	<p>E-72  E-73</p>
Characters flicker or colors are offset for RGB inputs	<ul style="list-style-type: none"> <li>Adjust the <b>Frequency Compensation</b>, and <b>Phase Control</b> items under <b>Image</b> of the <b>Advanced Menu</b>.</li> </ul>	<p>E-64, 65</p>
Cannot select the menu name	<ul style="list-style-type: none"> <li>Some of the functions cannot be selected unless a signal is input to the projector and video or an image is being projected.</li> </ul>	<p>—</p>

## At a time such as this...

Problem	Check	Reference Page
Remote control unit does not operate	<ul style="list-style-type: none"> <li>• Are the remote control unit's batteries worn? Replace with new batteries.</li> <li>• Is there an obstacle between the remote control unit and the projector's remote control signal sensor?</li> <li>• Is the remote control unit outside of range?</li> <li>• Are you pointing the remote control unit's transmitter towards the projector's remote control signal sensor?</li> <li>• Is the projector located near fluorescent lighting?</li> </ul>	<p><b>E-19, 20</b>  <b>E-20</b>  <b>E-20</b>  <b>E-20</b></p>
LAMP/HEAT indicator is lit red or flashing red	<ul style="list-style-type: none"> <li>• See "When an indicator is lit or flashing".</li> </ul>	<p><b>E-83</b></p>
Even when the power is turned on, only the display of "Please enter the password" is shown.	<ul style="list-style-type: none"> <li>• The password is set. Please enter the correct password.</li> </ul>	<p><b>E-75, 76</b></p>

- Be certain to disconnect the power plug from the power outlet before cleaning.
- Do not apply insecticide or other volatile chemicals to the projector or lens. Also, do not allow rubber or vinyl products or the like to remain in contact with the projector for a long period. This will cause deterioration or peeling of the coating, etc.

## Cleaning a Soiled Projector Main Unit

- Wipe with a lint-free, soft, dry cloth. When very dirty, wipe with a cloth that has been moistened with a diluted neutral detergent, then finish with a dry cloth. If a chemically-treated cloth is going to be used, please follow any written warnings.
- Do not wipe with thinner, benzene, or other solvents. Doing so could cause them to undergo qualitative changes or the coatings may peel, etc.
- When removing the dust of the outflow and intake holes, use the brush attachment on a vacuum cleaner to clean out the dust. Avoid using the vacuum directly without attaching the adapter as well as the use of a nozzle adapter.
- Do not scratch or otherwise hit the projector body with your nails or other hard object, since this will cause scratches.

## Dirty Lens

- Clean using the same method you would use to clean a camera lens: Use a commercial blower for camera use or cleaning paper for eye glasses. Be careful not to scratch the lens at this time.

## Dust of the Intake and Outflow Holes

Dust that collects in the intake and outflow holes will obstruct the ventilation and cause the internal temperature to rise which could cause damage. Clean this area carefully. As a guideline, clean at least every 100 hours of usage.

- Turn off the power and check that the indicator of the POWER/STANDBY button has changed so that it is lit in orange, and then disconnect the power cable.
- Vacuum from the outside with an electric vacuum cleaner. Use a brush-tipped adapter with the vacuum cleaner. Note that use of a vacuum without an adapter, or use of an adapter without a brush should be avoided.

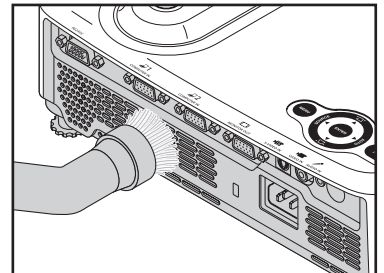

## Cleaning the Inside of the Projector

- Cleaning of the inside of the projector is required about once a year. Failure to clean over a long period while dust has collected inside the projector could cause a fire or breakdown. Do not clean the inside of the projector by yourself. Please be sure to contact your dealer.

## Replacing the Lamp Cartridge

- The lamp that is used in the light source of the projector has a service life. The rated service life of the lamp is approximately 2,000 hours for model **KG-PS232Xh/232X** (when used only in normal mode), and approximately 4,000 hours for model **KG-PV131X/131S**. Note that the lamp service life may be shortened due to usage conditions and other factors. The service life will be extended when the Eco mode is used proportionately longer (than the normal mode) with model **KG-PS232Xh/232X**.

(Rated service life means the average value of service life of lamps that were manufactured over a long period, and it depends on the manufacturer's test conditions. The rated service life is an average value that depends on the manufacturer's test conditions; it is not a guaranty of operation up to this time.)

- When the service life of the lamp is exceeded, the indicator of the POWER/STANDBY button will light in blue, the LAMP indicator will light in red, and the message "Replace the lamp cartridge." will be displayed on the screen. In this case, it is time to replace the lamp cartridge. Replace the lamp cartridge according to the procedure on the next page. See Page E-88.
- When the lamp has been used for more than 100 hours after reaching its service life, the projector will enter the standby mode and it will no longer be possible to turn on the power.
- Replacement lamps can be obtained at dealers. When ordering, please specify the replacement lamp for projector **KG-PS232Xh/KG-PS232X** (lamp model **KG-LPS2230** / order code **600-377**), or the replacement lamp for projector **KG-PV131X/KG-PV131S** (lamp model **KG-LPV1200** / order code **600-278**).



### CAUTION

- Replacement of the lamp cartridge is performed after switching off the power, waiting for the cooling fan to stop, disconnecting the power plug from the power outlet, and then leaving the projector for about 60 minutes before replacement is started. Replacement of the lamp cartridge during operation or immediately after operation stops will cause burns because of the high temperature.
- Do not loosen any screws other than those specified.
- Do not touch the lamp with bare hands. Doing so could shorten the life of the lamp.
- If lamp has reached the end of its usable life, the lamp bulb may shatter. When this happens, an explosive sound can be heard and pieces of glass may be scattered in the lamp cartridge. Do not touch them as the pieces of glass may cause injury. If this happens, contact your dealer or the store the projector was purchased.

## Replacing the Lamp Cartridge

**1** Unplug the power cable.

**2** Turn the projector upside-down.

Lay down a soft cloth or other material, and place the projector on top of it to aid in lamp replacement. After replacement, return the projector to its original condition.

**3** Remove the lamp cover.

(1) Press the 2 tabs of the lamp cover and lift upward.

(2) Pull and remove in the direction of the arrows.

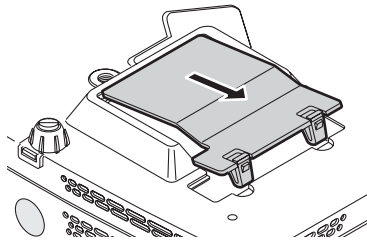
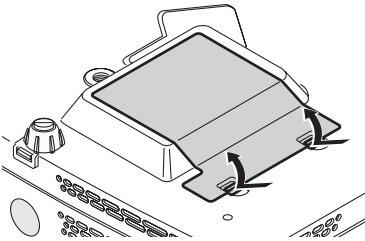

**4** Remove the lamp cartridge.

(1) Loosen the 2 screws of the lamp cartridge by turning counter-clockwise until they turn freely. (The screws will not come out.)

(2) Grasp the handles of the lamp cartridge and pull upward to remove the cartridge.

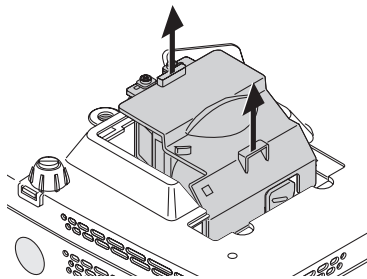
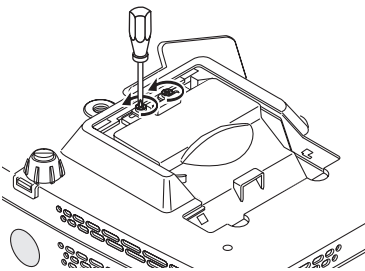



## Replacing the Lamp Cartridge

### 5 Install the new lamp cartridge.

- (1) Slowly push in the lamp cartridge. (Align with the screw holes of the projector.)
- (2) Press firmly from above, then turn the 2 screws of the lamp cartridge clockwise to tighten.

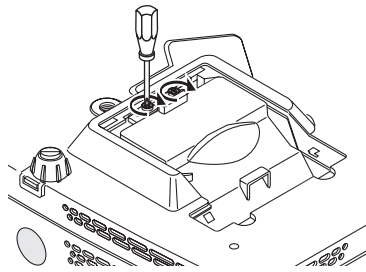
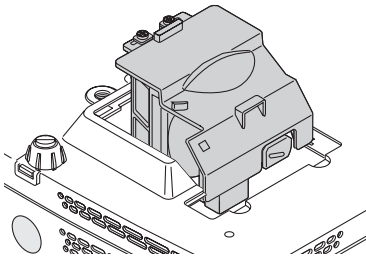

### 6 Install the lamp cover.

- (1) Insert the edge of the lamp cover into the projector and then close the lamp cover.
- (2) Insert the tabs of the lamp cover until a "click" sound is heard.

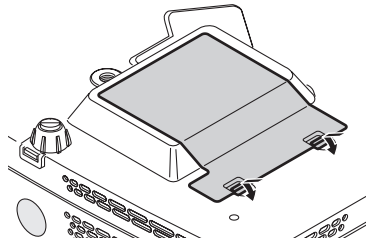
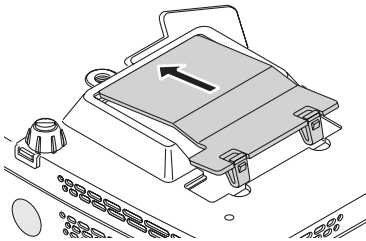

### 7 Reset the Lamp Timer.

Connect the power cable, turn on the power, then reset. Select **Admin** under **Advanced Menu** ► **Lamp Timer Reset**, and then press the ENTER button. There will be a change to the initialization verification display. Now press the ENTER button. See "Lamp Timer Reset" for details on Page E-80.

#### Note

- When the lamp has been used for more than 100 hours after reaching its service life, the power will no longer turn on. Should this happen, simultaneously holding down the projector's SOURCE button and AUTO button for more than 5 seconds in the standby mode will clear the lamp timer. Checking that the LAMP indicator is off will show that the lamp timer has been cleared.
- Replacement lamps can be obtained at dealers. When ordering, please specify the replacement lamp for projector **KG-PS232Xh/KG-PS232X** (lamp model **KG-LPS2230** / order code **600-377**), or the replacement lamp for projector **KG-PV131X/KG-PV131S** (lamp model **KG-LPV1200** / order code **600-278**).

# Specifications List

<b>Model</b>	<b>KG-PS232Xh</b>
<b>Optical</b>	
Method of projection :	DLP® (single DLP® chip)
DLP® chip	0.55 inches 1024 × 768 dots
Lamp	230 W high pressure mercury lamp
Projection lens :	Manual zoom ( × 1.15), Auto focus F = 2.45 – 2.62, f = 18.7 – 21.5 mm
Image size	Minimum 31.3 inch (at projection distance of 1.20 m / 3.9 feet telephoto) Maximum 300 inch (at projection distance of 10.20 m / 33.46 feet wide)
Light Output	Standard mode: 3000 lm *1
Contrast Ratio	2000:1 (Full on/off) *1
<b>Electrical</b>	
Inputs	Video (NTSC/NTSC4.43/PAL/PAL-N/PAL-M/PAL60/SECAM/YCbCr(NTSC, PAL)/YPbPr(480p, 576p, 1080i, 720p)): (automatic or manual switching) RGB (Horizontal: 15 to 80 kHz, Vertical: 50 to 85 Hz) Full color (16,770,000 colors)
Color Reproduction	
Resolution	VGA (640 × 480) expansion/true, S-VGA (800 × 600) expansion/true XGA (1024 × 768) true, S-XGA (1280 × 1024) compression
Input Current	3.0 A
Power Requirement	100 - 240 V AC, 50/60 Hz
Power Consumption	300 watts (245 watts in eco mode)
<b>Mechanical</b>	
Dimensions Excluding Stand	260 mm (W) × 58 mm (H) × 210 mm (D) (when stored, not including projecting parts) 10.2 in.(W) × 2.3 in.(H) × 8.3 in.(D) (when stored, not including projecting parts)
Weight	Approximately 1.9 kg / 4.2 lbs
Operational Temperatures	Data projector: 5° to 35°C (41° to 95°F), 10 to 85% humidity

• Specifications and design are subject to change without notice.

\*1 ISO 21118 conformance: Indicates the average value of mass produced articles, and the lower limit values at the time of shipping are 80% of the indicated values.

# Specifications List

<b>Model</b>	<b>KG-PS232X</b>
<b>Optical</b>	
Method of projection :	DLP® (single DLP® chip)
DLP® chip	0.55 inches 1024 × 768 dots
Lamp	230 W high pressure mercury lamp
Projection lens :	Manual zoom ( × 1.15), Auto focus F = 2.45 – 2.62, f = 18.7 – 21.5 mm
Image size	Minimum 31.3 inch (at projection distance of 1.20 m / 3.9 feet telephoto) Maximum 300 inch (at projection distance of 10.20 m / 33.46 feet wide)
Light Output	Standard mode: 2500 lm *1
Contrast Ratio	2000:1 (Full on/off) *1
<b>Electrical</b>	
Inputs	Video (NTSC/NTSC4.43/PAL/PAL-N/PAL-M/PAL60/SECAM/YCbCr(NTSC, PAL)/YPbPr(480p, 576p, 1080i, 720p)): (automatic or manual switching) RGB (Horizontal: 15 to 80 kHz, Vertical: 50 to 85 Hz) Full color (16,770,000 colors)
Color Reproduction	
Resolution	VGA (640 × 480) expansion/true, S-VGA (800 × 600) expansion/true XGA (1024 × 768) true, S-XGA (1280 × 1024) compression
Input Current	3.0 A
Power Requirement	100 - 240 V AC, 50/60 Hz
Power Consumption	300 watts (245 watts in eco mode)
<b>Mechanical</b>	
Dimensions Excluding Stand	260 mm (W) × 58 mm (H) × 210 mm (D) (when stored, not including projecting parts) 10.2 in.(W) × 2.3 in.(H) × 8.3 in.(D) (when stored, not including projecting parts)
Weight	Approximately 1.9 kg / 4.2 lbs
Operational Temperatures	Data projector: 5° to 35°C (41° to 95°F), 10 to 85% humidity

• Specifications and design are subject to change without notice.

\*1 ISO 21118 conformance: Indicates the average value of mass produced articles, and the lower limit values at the time of shipping are 80% of the indicated values.

# Specifications List

<b>Model</b>	<b>KG-PV131X</b>
<b>Optical</b>	
Method of projection :	DLP® (single DLP® chip)
DLP® chip	0.55 inches 1024 × 768 dots
Lamp	200 W high pressure mercury lamp
Projection lens :	Manual zoom ( × 1.15), Manual focus F = 2.45 – 2.62, f = 18.7 – 21.5 mm
Image size	Minimum 31.3 inch (at projection distance of 1.20 m / 3.9 feet telephoto) Maximum 300 inch (at projection distance of 10.20 m / 33.46 feet wide)
Light Output	Standard mode: 2000 lm *1
Contrast Ratio	2000:1 (Full on/off) *1
<b>Electrical</b>	
Inputs	Video (NTSC/NTSC4.43/PAL/PAL-N/PAL-M/PAL60/SECAM/YCbCr(NTSC, PAL)/YPbPr(480p, 576p, 1080i, 720p)): (automatic or manual switching) RGB (Horizontal: 15 to 80 kHz, Vertical: 50 to 85 Hz) Full color (16,770,000 colors)
Color Reproduction	
Resolution	VGA (640 × 480) expansion/true, S-VGA (800 × 600) expansion/true XGA (1024 × 768) true, S-XGA (1280 × 1024) compression
Input Current	2.5 A
Power Requirement	100 - 240 V AC, 50/60 Hz
Power Consumption	245 watts
<b>Mechanical</b>	
Dimensions Excluding Stand	260 mm (W) × 58 mm (H) × 210 mm (D) (when stored, not including projecting parts) 10.2 in.(W) × 2.3 in.(H) × 8.3 in.(D) (when stored, not including projecting parts)
Weight	Approximately 1.9 kg / 4.2 lbs
Operational Temperatures	Data projector: 5° to 35°C (41° to 95°F), 10 to 85% humidity

• Specifications and design are subject to change without notice.

\*1 ISO 21118 conformance: Indicates the average value of mass produced articles, and the lower limit values at the time of shipping are 80% of the indicated values.

# Specifications List

<b>Model</b>	<b>KG-PV131S</b>
<b>Optical</b>	
Method of projection :	DLP® (single DLP® chip)
DLP® chip	0.55 inches 800 × 600 dots
Lamp	200 W high pressure mercury lamp
Projection lens :	Manual zoom ( × 1.15), Manual focus F = 2.45 – 2.62, f = 18.7 – 21.5 mm
Image size	Minimum 31.3 inch (at projection distance of 1.20 m / 3.9 feet telephoto) Maximum 300 inch (at projection distance of 10.20 m / 33.46 feet wide)
Light Output	Standard mode: 2000 lm *1
Contrast Ratio	2000:1 (Full on/off) *1
<b>Electrical</b>	
Inputs	Video (NTSC/NTSC4.43/PAL/PAL-N/PAL-M/PAL60/SECAM/YCbCr(NTSC, PAL)/YPbPr(480p, 576p, 1080i, 720p)): (automatic or manual switching) RGB (Horizontal: 15 to 80 kHz, Vertical: 50 to 85 Hz) Full color (16,770,000 colors)
Color Reproduction	
Resolution	VGA (640 × 480) expansion/true, S-VGA (800 × 600) true XGA (1024 × 768) compression
Input Current	2.5 A
Power Requirement	100 - 240 V AC, 50/60 Hz
Power Consumption	245 watts
<b>Mechanical</b>	
Dimensions Excluding Stand	260 mm (W) × 58 mm (H) × 210 mm (D) (when stored, not including projecting parts) 10.2 in.(W) × 2.3 in.(H) × 8.3 in.(D) (when stored, not including projecting parts)
Weight	Approximately 1.9 kg / 4.2 lbs
Operational Temperatures	Data projector: 5° to 35°C (41° to 95°F), 10 to 85% humidity

• Specifications and design are subject to change without notice.

\*1 ISO 21118 conformance: Indicates the average value of mass produced articles, and the lower limit values at the time of shipping are 80% of the indicated values.

## Table of Supported Frequency

The projector automatically identifies the signal input from the computer and selects the optimum resolution as shown on the table below.

Manual adjustments may be required for some input signals. See "Frequency Compensation"/"Phase Control"/"Horizontal Position / Vertical Position" on page E-64, 65, 68.

Signal	Resolution	Frequency		Video	Component	Digital	Analog
		Horizontal (kHz)	Vertical (Hz)				
VIDEO(NTSC)	—	15.734	60.0	○	○	—	—
VIDEO(PAL/SECAM)	—	15.625	50.0	○	○	—	—
PC/AT	640 × 350	31.5	70.1	—	—	—	○
	640 × 400	31.5	70.1	—	—	—	○
	720 × 350	31.5	70.0	—	—	—	○
	720 × 400	31.5	70.0	—	—	—	○
VESA	640 × 350	37.9	85.1	—	—	—	○
	640 × 400	37.9	85.1	—	—	—	○
	720 × 400	37.9	85.0	—	—	—	○
	640 × 480	31.5	60.0	—	—	—	○
	640 × 480	37.9	72.8	—	—	—	○
	640 × 480	37.5	75.0	—	—	—	○
	640 × 480	43.3	85.0	—	—	—	○
	800 × 600	35.2	56.3	—	—	—	○
	800 × 600	37.9	60.3	—	—	—	○
	800 × 600	46.9	75.0	—	—	—	○
	800 × 600	48.1	72.2	—	—	—	○
	800 × 600	53.7	85.1	—	—	—	○
	1024 × 768	48.4	60.0	—	—	—	○
	1024 × 768	56.5	70.1	—	—	—	○
	1024 × 768	60.0	75.0	—	—	—	○
1024 × 768	68.7	85.0	—	—	—	○	
1280 × 1024	64.0	60.0	—	—	—	○	
Apple Macintosh	640 × 480	35.0	66.7	—	—	—	○
	832 × 624	49.7	74.5	—	—	—	○
	1024 × 768	60.2	74.9	—	—	—	○
	1152 × 870	68.7	75.1	—	—	—	○
HDTV (1080i)	1920 × 1080	33.8	60.0	—	○	—	—
	1920 × 1080	28.1	50.0	—	○	—	—
(720p)	1280 × 720	45.0	60.0	—	○	—	—
EDTV (576p)	720 × 576	31.3	50.0	—	○	—	—
	720 × 480	31.5	60.0	—	○	—	—
SDTV (576i)	720 × 576	15.625	50.0	—	○	—	—
	720 × 480	15.734	60.0	—	○	—	—

• The projector does not support the ADC connector on Apple Macintosh.

○ : Supported frequency  
 — : Not supported frequency

### KG-PS232Xh/KG-PS232X/KG-PV131X

The display resolution is 1024 × 768 dots. When displaying a signal with resolutions other than 1024 × 768 dots such as 1280 × 1024, sizes of characters or lines may be uneven.

### KG-PV131S

The display resolution is 800 × 600 dots. When displaying a signal with resolutions other than 800 × 600 dots such as 1024 × 768, sizes of characters or lines may be uneven.

# Cabinet Dimensions

## KG-PS232Xh/232X

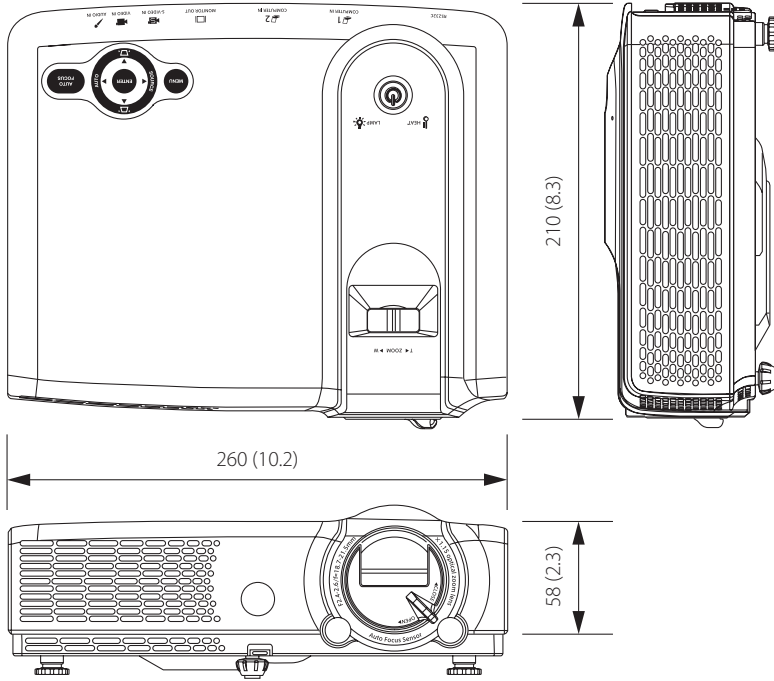

## KG-PV131X/131S

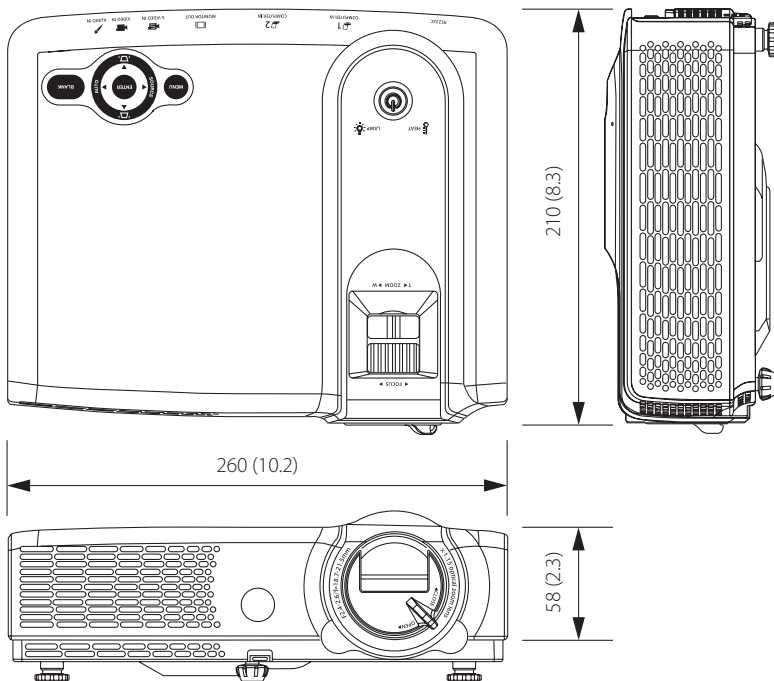

Unit: mm (inch)

<http://www.taxan-projector.com>

**加賀コンポーネント株式会社**

〒113-0033 東京都文京区本郷2-2-9  
センチュリータワー

加賀コンポーネント・プロジェクト  
カスタマーセンター

 **0120-331-059**

**KAGA COMPONENTS CO.,LTD.**

2-2-9 Hongo, Bunkyo-ku Tokyo  
113-0033, Japan

Tel: +81-3-4455-3178

Fax: +81-3-3814-4544