

HITACHI

Inspire the Next

Instruction Manual



MultiMediaCard™

DZ-MV350A
DZ-MV380A

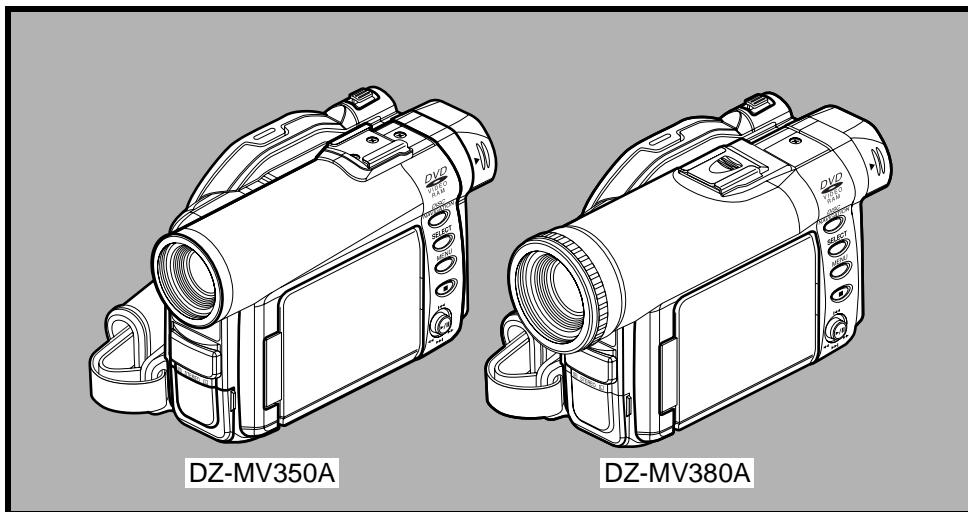

HITACHI AMERICA, LTD. HOME ELECTRONICS DIVISION

1855 Dornoch Court
San Diego, CA 92154-7225
Tel. 1-800-HITACHI
(1-800-448-2244)

HITACHI CANADA LTD. DIGITAL MEDIA DIVISION

6740 Campobello Road
Mississauga, Ontario L5N 2L8
CANADA
Tel. 1-800-HITACHI
(1-800-448-2244)

Thank you for buying a Hitachi product. Please take time to become familiar with the manual and how it is set up. Keep it handy for future reference.



This manual was printed
with soy based ink.

Printed on recycled paper
Printed in Japan OM-M(I)

Important Information

For Your Safety

The power switch turns the DVD video camera/recorder on and off, leaving the date/time feature unaffected. If the camera/recorder is to be left unattended for a long period of time, turn it off.

WARNING : TO PREVENT FIRE OR SHOCK HAZARD, DO NOT EXPOSE THIS UNIT TO RAIN OR MOISTURE.

WARNING : TO PREVENT FIRE OR SHOCK HAZARD, USE THE RECOMMENDED ACCESSORIES ONLY.



WARNING: TO PREVENT FIRE OR SHOCK HAZARD, BE SURE TO USE THE SPECIFIED AC ADAPTER/CHARGER (DZ-ACS1).

The DVD video camera/recorder and AC adapter/charger have the following caution marks.



CAUTION

**RISK OF ELECTRIC SHOCK
DO NOT OPEN**



CAUTION: TO REDUCE THE RISK OF ELECTRIC SHOCK, DO NOT OPEN.
NO USER-SERVICEABLE PARTS INSIDE.
REFER SERVICING TO QUALIFIED SERVICE PERSONNEL.

Identifications of caution marks



This symbol warns the user that uninsulated voltage within the unit may have sufficient magnitude to cause electric shock. Therefore, it is dangerous to make any kind of contact with any inside part of this unit.



This symbol alerts the user that important literature concerning the operation and maintenance of this unit has been included. Therefore, it should be read carefully to avoid any problems.

Precautions

WARNING: Many television programs and films are copyrighted. In certain circumstances, copyright law may apply to private in-home videotaping of copyrighted materials.

This Class B digital apparatus complies with Canadian ICES-003.

The liquid crystal display (LCD) panel is made by highly precise technology. More than 99.99% of its picture elements (pixels) are effective, but some (less than 0.01%) may appear as colored bright dots. This does not indicate a fault as the LCD panel stretches the limits of current technology.

**CLASS 1
LASERPRODUCT**

CAUTION

This product contains a laser diode of higher class than 1. To ensure continued safety, do not remove any covers or attempt to gain access to the inside of the product. Refer all servicing to qualified personnel.

Warning: This device complies with Part 15 of the FCC Rules. Operation is subject to the following two conditions: (1) This device may not cause harmful interference, and (2) this device must accept any interference received, including interference that may cause undesired operation.

Note: This equipment has been tested and found to comply with the limits for a Class B digital device, pursuant to Part 15 of the FCC Rules. These limits are designed to provide reasonable protection against harmful interference in a residential installation. This equipment generates, uses, and can radiate radio frequency energy and, if not installed and used in accordance with the instructions, may cause harmful interference to radio communications. However, there is no guarantee that interference will not occur in a particular installation. If this equipment does cause harmful interference to radio or television reception, which can be determined by turning the equipment off and on, the user is encouraged to try to correct by one or more of the following measures:

- Reorient or relocate the receiving antenna.
- Increase the separation between the equipment and receiver.
- Connect the equipment into an outlet on a circuit different from that to which the receiver is connected.
- Consult the dealer or an experienced radio/TV technician for help.

Caution to the user: Changes or modifications not expressly approved by the manufacturer void the user's authority to operate the equipment.

Microsoft[®], Windows[®], Windows[®] 98, Windows[®] 98 Second Edition, Windows[®] Me, Windows[®] 2000 Professional, and Windows[®] XP are registered trademarks of Microsoft Corporation.

Intel[®], Pentium[®] Processor, and Celeron[®] Processor are registered trademarks of Intel Corporation.

IBM[®] and PC/AT[®] are registered trademarks of International Business Machines Corporation.

Manufactured under license from Dolby Laboratories.

“Dolby” and the double-D symbol are trademarks of Dolby Laboratories.

Other company names and product names listed are trademarks or brand names belonging to each individual company.

SD logo is a trademark.

IMPORTANT SAFEGUARDS

In addition to the careful attention devoted to quality standards in the manufacture of your video product, safety is a major factor in the design of every instrument. But, safety is your responsibility too.

This page lists important information that will help to assure your enjoyment and proper use of DVD video camera/recorder and accessory equipment. Please read it carefully before operating your video product and keep it in a handy place for future reference.

INSTALLATION

- 1 Read and Follow Instructions** — All the safety and operating instructions should be read before the video product is operated. Follow all operating and use instructions.



- 2 Retain Instructions** — The safety and operating instructions should be retained for future reference.
- 3 Heed Warnings** — Comply with all warnings on the video product and in the operating instructions.
- 4 Power Sources** — This video product should be operated only from the type of power source indicated on the marking label. If you are not sure of the type of power supply to your home, consult your video dealer or local power company. For video products intended to operate from battery power, or other sources, refer to the operating instructions.

- 5 Overloading** — Do not overload wall outlets and extension cords as this can result in a risk of fire or electric shock. Overloaded AC outlets and extension cords are dangerous, and so are frayed power cables, damaged or cracked wire insulation and broken plugs. They may result in a shock or fire hazard. Periodically examine the cord and have it replaced by your service technician if appearance indicates damage or deteriorated insulation.



- 6 Power-Cord Protection** — Power-supply cords should be routed so that they are not likely to be walked on or pinched by items placed upon or against them, paying particular attention to cords at plugs, convenience receptacles, and the point where they exit from the appliance.

- 7 Ventilation** — Slots and openings in the cabinet are provided for ventilation to ensure reliable operation of the video product and to protect it from overheating. These openings must not be blocked or covered. The openings should never be blocked by placing the video product on a bed, sofa, rug, or other similar surface. This video product should never be placed near or over a radiator or heat register. This video product should not be placed in a built-in installation such as a bookcase or rack unless proper ventilation is provided or the video product manufacturer's instructions have been followed.



- 8 Attachments** — Do not use attachments unless recommended by the video product manufacturer as they may cause hazards.

Caution: Maintain electrical safety. Powerline operated equipment or accessories connected to this unit should bear the UL listing mark or CSA certification mark on the accessory itself and should not have been modified so as to defeat the safety features. This will help avoid any potential hazard from electric shock or fire. In if doubt, contact qualified service personnel.

- 9 Water and Moisture** — Do not use this video product near water — for example, near a bath tub, wash bowl, kitchen sink, or laundry tub, in a wet basement, or near a swimming pool, and the like.

- 10 Accessories** — Do not place this video product on an unstable cart, stand, tripod, bracket, or table. The video product may fall, causing serious injury to a child or adult, and serious damage to the appliance. Use only with a cart, stand, tripod, bracket, or table recommended by the manufacturer, or sold with the video product. Any mounting of the product should follow the manufacturer's instructions, and should use a mounting accessory recommended by the manufacturer.

- 11** An appliance and cart combination should be moved with care. Quick stops, excessive force, and uneven surfaces may cause the appliance and cart combination to overturn.



S3175A

- 12 Power Lines** — An outside antenna system should not be located in the vicinity of overhead power lines or other electric light or power circuits, or where it can fall into such power lines or circuits. When installing an outside antenna system, extreme care should be taken to keep from touching or approaching such power lines or circuits as contact with them might be fatal. Installing an outdoor antenna can be hazardous and should be left to a professional antenna installer.

USE

- 13 Cleaning** — Unplug this video product from the wall outlet before cleaning. Do not use liquid cleaners or aerosol cleaners. Use a damp cloth for cleaning.
- 14 Object and Liquid Entry** — Never push objects of any kind into this video product through openings as they may touch dangerous voltage points or short-out parts that could result in a fire or electric shock. Never spill liquid of any kind on the video product.

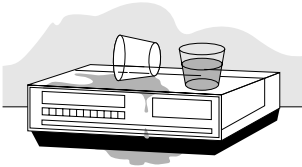

- 15 Lightning** — For added protection for this video product during a lightning storm, or when it is left unattended and unused for long periods of time, unplug it from the wall outlet and disconnect the antenna or cable-system. This will prevent damage to the video product due to lightning and power-line surges.



This product may contain lead and mercury. Disposal of these materials be regulated due to environmental considerations. For the disposal or recycling information, please contact your local authorities or the Electronics Industries Alliance : "www.eia.org."

SERVICE

- 16 Servicing** — Do not attempt to service this video product yourself as opening or removing covers may expose you to dangerous voltage or other hazards. Refer all servicing to qualified service personnel.
- 17 Conditions Requiring Service** — Unplug this video product from the wall outlet and refer servicing to qualified service personnel under the following conditions.
- When the power-supply cord or plug is damaged.
 - If liquid has been spilled, or objects have fallen into the video product.
 - If the video product has been exposed to rain or water.
 - If the video product does not operate normally by following the operating instructions. Adjust only those controls that are covered by the operating instructions. Improper adjustment of other controls may result in damage and will often require extensive work by a qualified technician to restore the video product to its normal operation.
 - If the video product has been dropped or the cabinet has been damaged.
 - When the video product exhibits a distinct change in performance — this indicates a need for service.

- 18 Replacement Parts** — When replacement parts are required, have the service technician verify that the replacements he uses have the same safety characteristics as the original parts. Use of replacements specified by the video product manufacturer can prevent fire, electric shock or other hazards.

- 19 Safety Check** — Upon completion of any service or repairs to this video product, ask the service technician to perform safety checks recommended by the manufacturer to determine that the video product is in safe operating condition.

- 20 Heat** — The product should be situated away from heat sources such as radiators, heat registers, stoves, or other products (including amplifiers) that produce heat.

Cautions When Using

Handle the liquid crystal display (LCD) with care:

- The LCD is a very delicate display device: Do not press its surface with force, hit it or prick it with a sharp object.
- If you push the LCD surface, unevenness in display may occur. If unevenness does not disappear soon, turn the DVD video camera/recorder off, wait for a few moments, and then turn it on again.
- Do not place the DVD video camera/recorder with the open LCD screen down.
- Close the LCD monitor when not using the DVD video camera/recorder.

Liquid crystal display and viewfinder:

- The LCD screen and viewfinder are the products of highly precise technology. Among the total number of pixels (approx. 120,000 pixels for LCD monitor and approx. 110,000 pixels for viewfinder), 0.01% or less pixels may be missing (black dots) or may remain lit as colored dots (red, blue, green). This shows the limitations of the current technology, and does not indicate a fault that will interfere with recording.
- The LCD screen and viewfinder will be slightly dimmer than usual when the DVD video camera/recorder is at low temperature, as in cold areas, or immediately after power is turned on. Normal brightness will be restored when the temperature inside the DVD video camera/recorder rises.

Hold the DVD video camera/recorder correctly:

- Do not hold the viewfinder or LCD monitor when lifting the DVD video camera/recorder: The viewfinder or LCD monitor could detach and the DVD video camera/recorder may fall.

Do not subject the DVD video camera/recorder to impact:

- This DVD video camera/recorder is a precision machine. Take great care that you do not strike it against a hard object or let it fall.
- Do not use the DVD video camera/recorder on a tripod in a place where it is subject to severe vibrations or impact.

No sand or dust!

- Fine sand or dust entering the DVD video camera/recorder or AC adapter/charger could cause malfunctions or defects.

No water or oil!

- Water or oil entering the DVD video camera/recorder or AC adapter/charger could cause electric shock, malfunctions or defects.

Heat on surface of product:

- The surface of the DVD video camera/recorder will be slightly warm, but this does not indicate a fault.

Screen on connected TV:

- Never leave the disc navigation screen, still image or camera image displayed on your TV to which the DVD video camera/recorder is connected: Doing so could result in displayed image retention or phosphor degradation of TV screen.

Be careful of ambient temperature:

- Using the DVD video camera/recorder in a place where the temperature is over 140°F (40°C) or under 32°F (0°C) will result in abnormal recording/playback.
- Take care that the temperature of this DVD video camera/recorder, when connected to PC does not rise excessively (reference for usage: approx. 30 minutes at about 86°F (30°C)).
- Do not leave the DVD video camera/recorder on beach sand or in a closed vehicle where the temperature is very high for a long time: This could cause malfunctions.

Do not point directly at the sun:

- If direct sunlight strikes the lens or viewfinder, the DVD video camera/recorder could malfunction or a fire could occur.
- Do not leave the DVD video camera/recorder with the LCD screen exposed to direct sunlight: This could cause malfunctions.

Do not use the DVD video camera/recorder near TV or radio:

- This could cause noise to appear on the TV screen or in radio broadcasts.

Do not use the DVD video camera/recorder near strong radio waves or magnetism:

- If the DVD video camera/recorder is used near strong radio waves or magnetism, such as near a radio wave tower or electric appliances, noise could enter video and audio that are being recorded. During playback of normally recorded video and audio, noise may also be present in picture and sound. At worst the DVD video camera/recorder could malfunction.

Do not expose the DVD video camera/recorder to soot or steam:

- Thick soot or steam could damage the DVD video camera/recorder case or cause malfunctions.

Do not use the DVD video camera/recorder near corrosive gas:

- Using it in a place where there is dense exhaust gas generated by gasoline or diesel engines, or corrosive gas such as hydrogen sulfide, could corrode the battery connecting terminals, which could result in loss of power.

Do not use the DVD video camera/recorder near ultrasonic humidifier:

- With some water in humidifier, calcium and other chemicals dissolved in water could scatter in the air, and white particles could adhere to the optical head of the DVD video camera/recorder, which could cause it to operate abnormally.

Do not expose the DVD video camera/recorder to insecticide:

- Insecticide entering the DVD video camera/recorder could dirty the lens in laser pickup block, and in such a case the DVD video camera/recorder might not operate normally. Turn the DVD video camera/recorder off and cover it with vinyl sheet, etc. before using insecticide.

Do not use a generally available 8 cm CD lens cleaner:

- Cleaning the lens is not necessary when using this DVD video camera/recorder in the usual way.
- Using 8 cm CD lens cleaner could cause this DVD video camera/recorder to be faulty.

Be careful of moisture condensation:

- When you move the DVD video camera/recorder between places where the difference in temperatures is great - such as entering a lodge from a ski slope or going out of a cooled room or vehicle - condensation (vapor in air warmed or cooled to water droplets) could occur on the lens and/or inside the DVD video camera/recorder. If condensation occurs, do not open the cover of disc or card insertion block if possible. If condensation occurs on the lens, wipe it off with a soft, dry cloth. Even if the external surface of DVD video camera/recorder has dried, condensation may remain inside: Turn the DVD video camera/recorder off and leave it in a dry place for at least 1-2 hours before using it again.

Do not use the DVD video camera/recorder for a long uninterrupted period of time:

- This DVD video camera/recorder cannot be used for a long time continuously as a surveillance camera/monitor. If you use the DVD video camera/recorder for a long continuous period of time, the temperature of DVD video camera/recorder could exceed a limit and the recording/playback operation could be slowed down: In this case, turn it off and wait for a while before using it again.

Do not turn the DVD video camera/recorder off while the ACCESS/PC indicator or CARD ACCESS indicator is lit or blinking:

- The ACCESS/PC or CARD ACCESS indicator is lit or blinking to show that data is being written to disc or card, or being read from it. At this time, do not do any of the following, so as not to damage the data:
 - Remove battery
 - Disconnect AC adapter/charger
 - Plug or unplug PC connection cable
 - Remove disc or card
 - Subject DVD video camera/recorder to severe vibrations or impact.
 - Violently open or close the LCD monitor

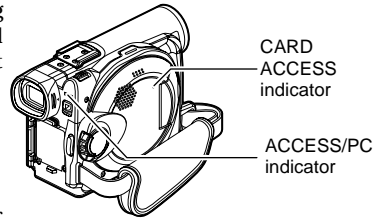

If you turn the DVD video camera/recorder off while the ACCESS/PC or CARD ACCESS indicator is lit or blinking, turn it on again with the disc or card loaded in it: Repair of the disc or card will be executed automatically (see page 149).

Do not wipe the DVD video camera/recorder case with benzene or thinner:

- The coating of case could peel off or the case surface could deteriorate.
- When using a chemical cleaning cloth, follow the instructions.

Also read the instructions attached with optional accessories:

- For optional accessories, observe the cautions and follow instruction manuals attached.

Cautions When Storing

Do not leave the DVD video camera/recorder in a place where the temperature is very high for a long period of time:

- The temperature inside a closed vehicle or trunk can become very high in a hot season. If you leave the DVD video camera/recorder in such a place, it could malfunction or the case could be damaged. Also, do not expose the DVD video camera/recorder to direct sunlight or place it near a heater.

Do not store the DVD video camera/recorder in a place where the humidity is high or in a dusty place:

- Dust entering the DVD video camera/recorder could cause malfunctions. If the humidity is high, the lens could be moldy, and the DVD video camera/recorder could become inoperable. It is recommended that you put the DVD video camera/recorder with desiccant in a box when storing it in a closet, etc.

Do not store the DVD video camera/recorder in a place subject to strong magnetism or intense vibrations:

- This could cause malfunctions.

Detach the battery from the DVD video camera/recorder and store it in a cool place:

- Leaving the battery attached or storing it at high temperature could shorten its life.

Suggestions and Restrictions

Make a trial recording:

- Always make a trial recording before doing actual recording to make sure that recording is normal. The data that have not been stored normally because of a defect in the DVD video camera/recorder cannot be restored.
It is recommended that you use DVD-RAM disc from which recorded contents can be deleted for trial recording.

Do not use the DVD video camera/recorder for professional applications:

- This DVD video camera/recorder is designed and produced for home-use recording and playback.

The recorded contents cannot be compensated for:

- Hitachi cannot compensate for any damages caused when recording is not made normally or recorded contents cannot be played back because of a defect in the DVD video camera/recorder, disc or card. Also, Hitachi cannot be responsible for your recorded video and audio.
- If you or a third party make a mistake when handling this DVD video camera/recorder, disc, card, etc., the recorded contents may be lost. We cannot be responsible for compensation for damage due to loss of recorded contents.

Copyright:

- Data recorded on the disc or card in this DVD video camera/recorder using other digital/analog media or devices are protected by the copyright act and cannot be used without permission of the owner of copyright, except for personal enjoyment. Be aware that recording is restricted for some demonstrations, performances and exhibitions, even for personal enjoyment.

Read This First

To guide you, we've included following six chapters.

- The section on “Setups” explains how to set up the DVD video camera/recorder, battery, and set the date/time.
- The section on “Basic Techniques” explains the basic operation of this DVD video camera/recorder - recording of movies, still images, external input, and playback of recorded images.
- The section on “Advanced Techniques” explains settings on this DVD video camera/recorder for more advanced usage.
- The section on “Disc Navigation” explains editing with Disc Navigation: Refer to this section when finalizing DVD-R disc and initializing DVD-RAM disc.
- The section on “Installing Software” explains the contents of provided CD-ROM and how to install the software included.
- “Subsidiary Information” includes an introduction to products sold separately, proper cleaning, and troubleshooting.

We want this manual to be as helpful as possible, so it includes two easy ways to find the information you need:

- A quick index for the information you use most often (this page).
- A detailed table of contents directing you to specific information quickly (see page 13-15).

Get to know your DVD video camera/recorder by using this manual, and get to know Hitachi. We appreciate your business.

Quick Index

Available Discs	22
Recording Movie.....	50
Immediately Checking Recorded Scene	67
Connecting to a TV	72
Functions Available with Disc Navigation	99
Installing Software	132

With this DVD video camera/recorder you can view the picture being recorded or the playback picture whether on the LCD monitor or in the viewfinder. Opening or closing the LCD monitor switches the picture to appear on the LCD monitor or in the viewfinder. The following text describes the operation assuming that the viewfinder is used as a major monitor device.

Introduction

● You can record even during playback

Unlike tape devices, you do not need to search for the recording start position or locate the beginning of blank portion.

You can start recording during playback: New recording will not overwrite any previously recorded data.

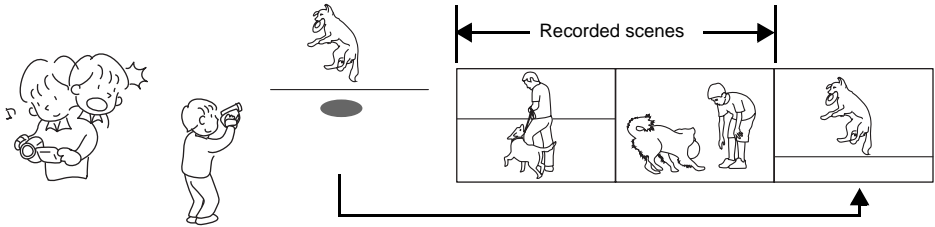

If you stop playback midway and start recording, overwrite will not occur.

● You can immediately play back desired recorded scenes

You do not need to rewind, unlike recorders using tape.

You can select any scene you want and immediately play it back (using Disc Navigation function).

● Use Disc Navigation to create your original movie

You can delete unnecessary scenes, move any scenes, etc., and create your original movie work (Play List).

Before editing

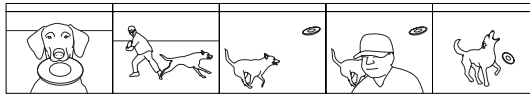

After editing

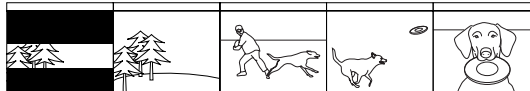

● **You can easily edit scenes, which is quite difficult with tape**

Using this DVD video camera/recorder, you can collect scenes of your child, for example, on play list of Disc Navigation function and create an original movie: Then simply play back the play list and dub it on VCR. It is also easy to make any number of identical tapes.

Up to now, you had to repeatedly press buttons

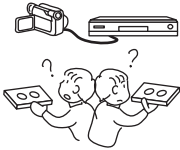

With DVD, you can simply play back this DVD video camera/recorder, and press the record button on VCR.

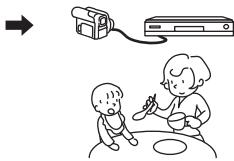

● **Create original DVDs on PC**

You can use a DVD-R disc to create an original DVD, using the provided software CD-ROM. The created DVD disc can be played back on DVD player, DVD-ROM drive, etc.



Original DVD being created



Playback of DVD

REPLACING DISC IN ROUND DVD HOLDER	76	Scene	101
WHEN THE HINGE OF ROUND DVD HOLDER COMES OFF	76	DELETING SCENES (DELETE)	101
DISC CLEANING	76	CHANGING IMAGES FOR THUMBNAILS (EDIT - THUMBNAIL)	103
Playback on DVD Video Recorder/Player	77	PLAYING BACK BY SKIPPING SCENES (EDIT - SKIP)	104
Advanced Techniques		ADDING SPECIAL EFFECTS (EDIT - FADE)	105
Understanding Flow of Menu	78	ARRANGING ORDER OF SCENES (EDIT - MOVE)	106
Setting Up Camera Functions	80	COMBINING MULTIPLE SCENES (EDIT - COMBINE)	107
SELECTING SHOOTING MODE TO MATCH THE SUBJECT (SWITCHING PROGRAM AE MODE)	80	DIVIDING MOVIES (EDIT - DIVIDE)	108
ADJUSTING COLOR (WHITE BALANCE)	81	COPYING STILLS ON DVD-RAM DISC TO CARD (COPY)	109
USING THE ELECTRONIC IMAGE STABILIZER (EIS)	83	LOCKING SCENES ON CARD (LOCK)	110
MAGNIFYING SUBJECT IMAGE (DIG. ZOOM)	84	DESIGNATING SCENES TO BE PRINTED (DPOF)	111
REDUCING WIND NOISE DURING RECORDING (MIC.FILTER)	85	SELECTING SCENES USING MENU SCREEN (SELECT)	112
Setting Up Record Functions	86	DISPLAYING INFORMATION USING MENU SCREEN (DETAIL)	113
SWITCHING MOVIE QUALITY (VIDEO MODE)	86	Program	114
SWITCHING QUALITY OF STILL IMAGE (QUALITY)	87	WHAT IS "PROGRAM"?	114
RECEIVING IMAGE FROM ANOTHER DEVICE (INPUT SOURCE)	88	SWITCHING TO THUMBNAIL DISPLAY OF SPECIFIC DATE (SWITCH)	114
SWITCHING EXTERNAL INPUT RECORDING METHOD (PHOTO INPUT)	88	PLAYING BACK PROGRAM (PLAY)	115
SELF-TIMER	89	CHANGING TITLE OF PROGRAM (TITLE)	115
SETTING ON-SCREEN DISPLAY OUTPUT ON OR OFF (OSD OUTPUT)	90	Play List	117
LCD Setup	91	WHAT IS "PLAY LIST"?	117
SETTING BRIGHTNESS OF LCD SCREEN (BRIGHTNESS)	91	CREATING NEW PLAY LIST (CREATE)	117
SETTING COLOR DENSITY OF LCD SCREEN (COLOR LEVEL)	91	SWITCHING TO DISPLAY OF EACH PLAY LIST (SWITCH)	118
Initial Settings	92	PLAYING BACK A PLAY LIST (PLAY)	119
SWITCHING OPERATING SOUND ON OR OFF (BEEP)	92	ADDING SCENES TO PLAY LIST (EDITING PLAY LIST)	120
TURNING DVD VIDEO CAMERA/RECORDER OFF AUTOMATICALLY (POWER SAVE)	92	DELETING SCENES FROM PLAY LIST (EDITING PLAY LIST)	121
TURNING RECORD LED ON OR OFF (RECORD LED)	93	ADDING SCENES USING SUBMENU FOR EDITING (EDITING PLAY LIST)	121
CHANGING DISPLAY LANGUAGE (LANGUAGE)	93	DELETING SCENES USING SUBMENU FOR EDITING (EDITING PLAY LIST)	122
RESETTING MENU SETTINGS TO DEFAULTS (RESET)	94	SELECTING SCENES USING SUBMENU FOR EDITING (EDITING PLAY LIST)	122
Disc Navigation		ARRANGING ORDER OF SCENES (MOVE)	123
Using Disc Navigation	95	CHANGING TITLE OF PLAY LIST (TITLE)	124
STARTING DISC NAVIGATION	95	DELETING PLAY LIST (DELETE)	124
TERMINATING DISC NAVIGATION	97	Go To	125
PLAYING BACK FROM DISC NAVIGATION SCREEN	97	TOP (END)	125
SELECTING MULTIPLE SCENES	98	Disc or Card Management	126
SELECTING CONSECUTIVE SCENES TOGETHER	98	VERIFYING REMAINING FREE SPACE ON DISC OR CARD (CAPACITY)	126
Disc Navigation Menu	99	PROTECTING DISC FROM WRITING (PROTECT DISC)	126
FUNCTIONS AVAILABLE WITH DISC NAVIGATION	99	INITIALIZING DVD-RAM DISC OR CARD (FORMAT DISC. FORMAT CARD)	127
UNDERSTANDING FLOW OF DISC NAVIGATION MENU	100	UPDATING CONTROL INFORMATION OF DVD-RAM DISC	128
		FINALIZING DVD-R DISC	129

Others	130
DISPLAYING MOVIES OR STILLS INDEPENDENTLY (CATEGORY)	130
PLAYING BACK SCENES REPEATEDLY (REPEAT PLAY)	130
SLIDE SHOW (CONTINUOUS PLAYBACK OF STILLS).....	131

Installing Software



Contents on Provided CD-ROM	133
INSTALLING USB DRIVER	135
INSTALLING UDF DRIVER (DVD-RAM DRIVER)	137
INSTALLING DVD-MovieAlbumSE	139
INSTALLING MyDVD	141
Creating DVD Video on PC from DVD-RAM Disc Recorded on DVD Video Camera/Recorder	143

Subsidiary Information

Cleaning.....	145
Changing Setting of Demonstration.....	146
No DVD Video Camera/Recorder Operation - Check the Following:	147
Trouble Messages	149
Troubleshooting.....	156
System Reset	163
Major Specifications.....	164
Introduction to Optional Accessories	166
CAMERA ACCESSORIES	166
POWER SUPPLY	166
INFORMATION ON SQUARE ADAPTER.....	166
To Order in the United States	167
BY PHONE	167
Index	168
Be sure to read the following before opening the package of CD-ROM.....	170

Checking Provided Accessories

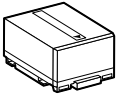
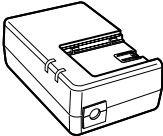
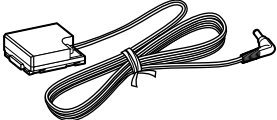
Make sure that you have all the following accessories in package:

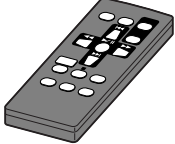
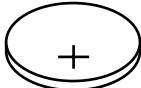
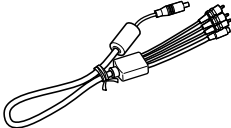
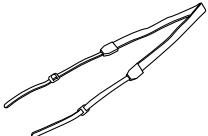
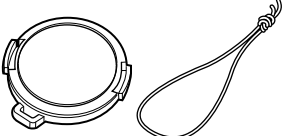
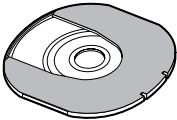
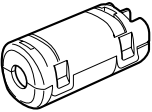
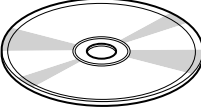
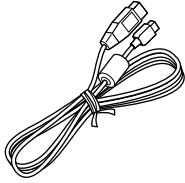
<p>Battery (model DZ-BP14S): Portable power supply for this DVD video camera/recorder. Charge it before use.</p> 	<p>AC adapter/charger (model DZ-ACS1): Used to power the DVD video camera/recorder from AC outlet, or charge battery.</p> 	<p>DC power cord: When powering the DVD video camera/recorder from household AC outlet, use this cord to connect the DVD video camera/recorder and AC adapter/charger.</p> 	
<p>Power cable: Connect between household AC outlet and AC adapter/charger.</p> 	<p>Infrared remote control (model DZ-RM3W): Use to control the DVD video camera/recorder from a distance.</p> 	<p>Lithium battery (model CR2025): To power the remote control.</p> <p>WARNING: Keep this battery away from children. If swallowed, consult a physician immediately for emergency treatment.</p> 	
<p>AV/S input/output cable: Used when viewing the picture played back on the DVD video camera/recorder on TV screen, or input or output video from/to another video device.</p> 	<p>Shoulder strap: Attach to the DVD video camera/recorder to hang it from shoulder.</p> 	<p>Lens cap and lens cap string: Attach the lens cap when not recording, to protect the lens.</p> 	
<p>8 cm DVD-R disc (in Round DVD Holder): To record video (movie) on this DVD video camera/recorder</p> 	<p>Ferrite core: In order to control radio noise emission, attach this to external microphone cable if you are using the external microphone.</p> 	<p>Software CD-ROM: Use this CD-ROM when connecting the DVD video camera/recorder to PC.</p> 	
<p>PC connection cable:</p> 			

Names of Parts

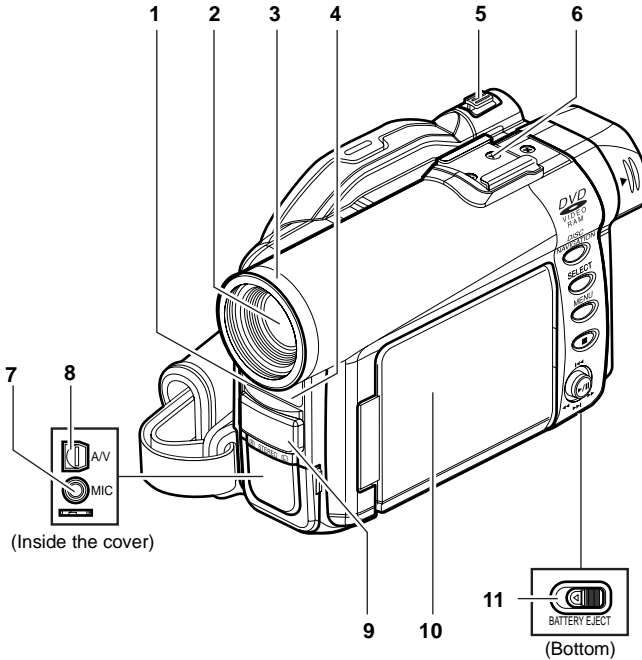

1 Recording indicator (P. 93)

The red indicator will light during recording.

2 Optical 10x zoom lens (P. 55)

3 Lens hood (P. 56)

Always remove this lens hood when using generally available tele-conversion or wide-conversion lens.

4 Infrared receiver (P. 35)

When the remote control is used to operate the DVD video camera/recorder, this receiver will receive the infrared signal.

5 Zoom lever (P. 55)

Push the lever to the T side for telephoto, or to the W side for wide-angle.

6 Accessory shoe

Only for DZ-MV380A:
Slide the cover to remove it, and then attach the optional video flash, etc., here. (See the instruction manual of device to be attached for details.)

7 External microphone jack (P. 52)

8 AV input/output jack (P. 65, 72)

9 Stereo microphone (P. 52)

10 2.5" type liquid crystal display (inside) (P. 46)

11 BATTERY EJECT switch (P. 37)

The BATTERY EJECT switch is located on the bottom of this DVD video camera/recorder:
Slide it when removing the battery.

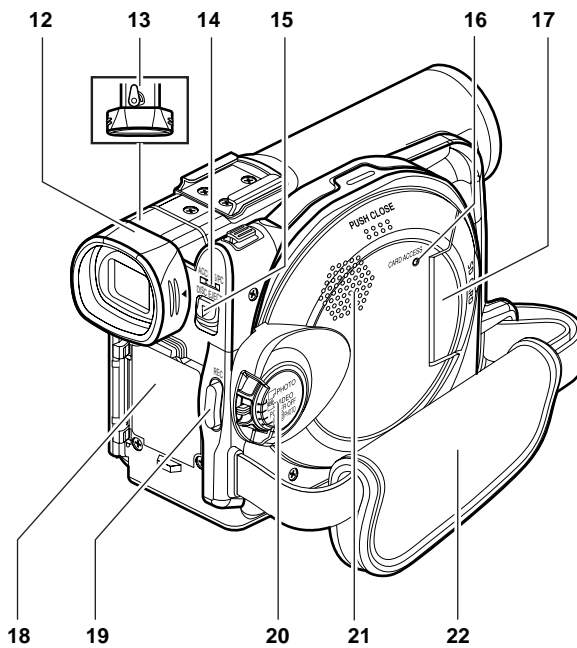

12 Viewfinder (P. 46)

13 Diopter control (P. 46)

To adjust the focus of image appearing in the viewfinder. (Pull out the viewfinder.)

14 ACCESS/PC indicator (P. 8, 50, 53)

Will blink or light while the DVD video camera/recorder is operating.

15 DISC EJECT button (P. 41)

Press down and release this button to open the disc guide.

16 CARD ACCESS indicator (P. 8, 53)

17 Card insertion block (P. 44)

18 Battery attachment platform (P. 37)

19 Record button (REC) (P. 50)

20 Power switch (P. 45, 50, 53)

21 Speaker (P. 67)

22 Hand strap (P. 32)

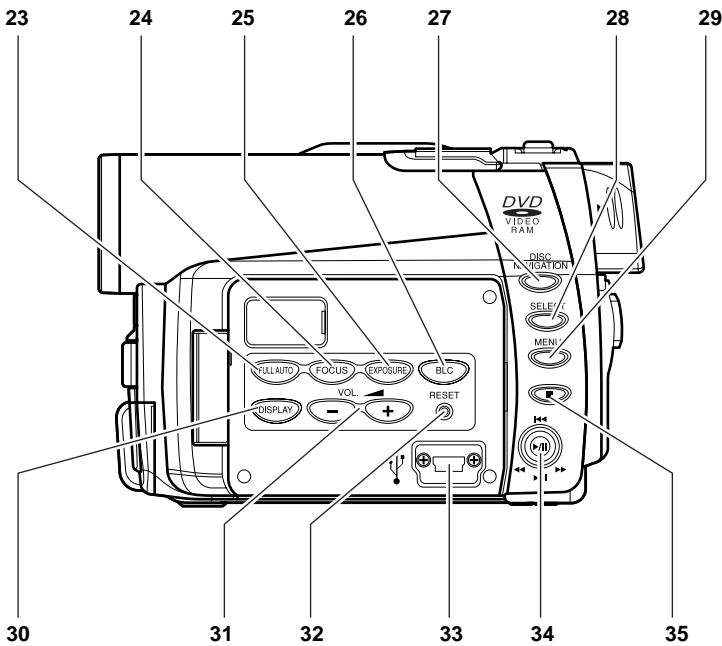

23 FULL AUTO button (P. 61)

To switch the DVD video camera/recorder to full automatic

24 FOCUS button (P. 57)

To switch between manual focus and auto-focus.

25 EXPOSURE button (P. 59)

Press this button to adjust the exposure.

26 BLC (backlight compensation) button (P. 60)

Press this button when subject is being lighted from rear.

27 DISC NAVIGATION button (P. 95)

28 SELECT button (P. 98)

29 MENU button (P. 48, 79, 101)

Press this button to display the menu for setting camera functions and Disc Navigation. The camera menu will appear even if disc is not loaded.

30 DISPLAY (Screen display) button (P. 71)

Press this button to display the details of image being played back or camera setting status, or switch the display off.

31 Volume control buttons (VOL) ⊖ ⊕ buttons (P. 57, 59, 67)

To adjust the volume of sound from speaker, etc.

32 RESET button (P. 163)

To reset all settings to defaults (status when the DVD video camera/recorder was shipped from the factory)

33 PC connection terminal (TO PC)

34 Joystick (P. 48, 67, 79)

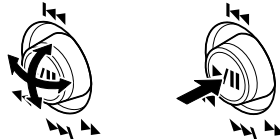

Move the joystick to select a scene or menu item; then play back the scene or pause it.

35 Stop/cancel button (P. 21, 67, 97)

To end playback or cancel setting of menu.

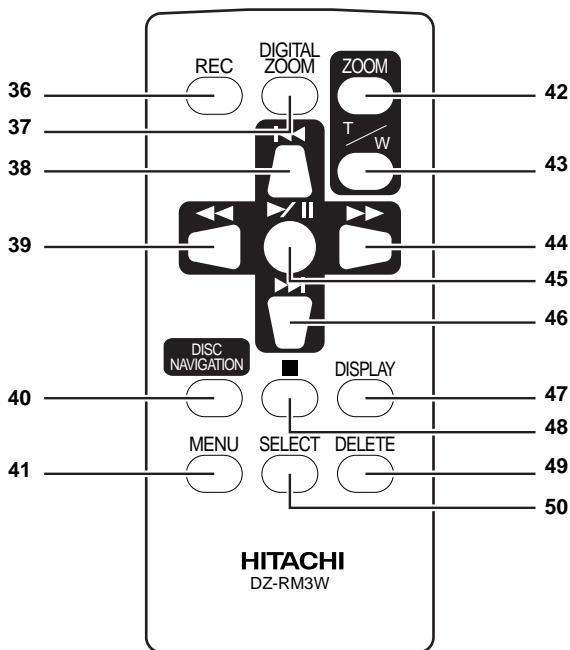

36 REC button (P. 50, 53)

37 DIGITAL ZOOM button (P. 84)

38 Reverse skip button (P. 69)

39 Reverse search button (P. 68)

40 DISC NAVIGATION button (P. 95)

41 MENU button (P. 48, 80, 102)

42 ZOOM T button (P. 55)

43 ZOOM W button (P. 55)

44 Forward search button (P. 68)

45 Play/pause button (P. 67)

46 Forward skip button (P. 69)

47 DISPLAY button (P. 71)

48 Stop button (P. 21, 67, 97)

49 DELETE button (P. 101)

50 SELECT button (P. 98)

* The buttons on remote control will function the same as those on DVD video camera/recorder.

About This Manual

● Displays in this manual

Understand that the displays are different from those you will actually see in the viewfinder or on the LCD screen.

● Notation of cancel button

Press the stop/cancel button to stop your operation midway, or return the menu screen to the preceding one. The expression “press the □ button” will be used in this text.

● , and marks beside headings

Some functions of this DVD video camera/recorder are unavailable with disc or card used. Refer to the marks at right above each function to identify whether the disc or card is compatible with the function. Refer to these marks and identify the functions and operation to match the disc or card you use.

● Illustrations in this manual

Although the external appearances of DZ-MV350A and DZ-MV380A are different, the method of operating both models is identical.

The illustrations of DZ-MV350A are used for the explanation in this text.

Discs and Cards

The following table lists the storage media (discs and cards) that can be used on this DVD video camera/recorder and the functions which are available with them:

Function	Media		
	DVD-RAM disc	DVD-R disc	SD memory card/ Multimedia card
Recording movie	∴	∴	x
Recording still	∴	x	∴
Deleting recorded image	∴	x	∴
Editing on this DVD video camera/recorder	∴	x	x
Playback on DVD player	x ^{*1}	∴ ^{*2}	x
Playback on DVD-RAM recorder	∴	∴ ^{*2}	x ^{*3}

∴: Functions available; x: Not available

*1: Can be played back on some DVD players.

*2: Must be finalized on this DVD video camera/recorder before DVD-R disc can be played back on DVD player or DVD recorder (See P. 74). May not be playable on some DVD players.

*3: Can be played back on some DVD-RAM recorders.

AVAILABLE DISCS

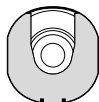

Usable discs and logos		Shape
DVD-RAM Ver. 2.1 (8 cm)		In Round DVD Holder
DVD-R [for General Ver. 2.0 (8 cm)]		

This DVD video camera/recorder uses 8 cm DVD-RAM discs and 8 cm DVD-R discs for camcorder use.

Discs removed from Round DVD Holder cannot be used on this DVD video camera/recorder: Use them only in the holder.

Note:

- It is recommended that you use Hitachi Maxell discs, since their compatibility with this DVD video camera/recorder has been confirmed. Using a disc other than those made by Hitachi Maxell may not allow the DVD video camera/recorder to deliver optimum performance.
- It is necessary to initialize an unformatted disc. When an unformatted disc is inserted into the DVD video camera/recorder, a message will appear: Initialize the disc following the instructions on screen (P. 127).

- The Round DVD Holder cannot be used on the following DVD video camera/recorders:
 - DZ-MV100A
 - DZ-MV230A/200A
 - DZ-MV270A
- Other DVD video camera/recorders that use square type adapters.
- Image data edited on PC and certain types of image data may not be visible on this DVD video camera/recorder.
- The image data recorded on another device may not be playable on this DVD video camera/recorder.

INFORMATION ON DVD-R DISC

You cannot record a still on DVD-R disc, or delete any recorded images or data.

For optimum recording on DVD-R disc, this DVD video camera/recorder writes control data to the disc in order to automatically make adjustments when it is inserted and ejected accompanying recording. If the disc has no area to be written for adjustment, recording may not be possible. To prevent this, do not insert or eject a DVD-R disc accompanying recording more than 50 times. The DVD video camera/recorder will not perform "write adjustment" when the DVD video camera/recorder is turned on again, from off, for recording with the disc in it, or when no recording is made, even if the disc is removed and then reinserted.

● Finalizing DVD-R disc

Before using the 8 cm DVD-R disc provided on this DVD video camera/recorder on a DVD player or DVD video recorder that is compatible with 8 cm DVD-R disc, the disc must be finalized on this DVD video camera/recorder. For the finalizing procedure of 8 cm DVD-R disc, refer to "Finalizing DVD-R Disc" (P. 129).

Note:

- Do not insert a DVD-R disc recorded on this DVD video camera/recorder but not finalized, into a recordable device, such as a DVD video recorder: The recorded data may be damaged.
- DVD-R discs edited and finalized on PC or those finalized on another DVD video recorder may not be playable on this DVD video camera/recorder, depending on the editing software used or recorded status of DVD-R disc.

EXAMPLES OF DISCS THAT CANNOT BE USED ON THIS DVD VIDEO CAMERA/RECORDER:

- DVD-RAM (2.6 GB) Ver. 1.0
- DVD-R (3.9 GB) Ver. 1.0
- DVD-R (4.7 GB) for Authoring Ver. 2.0
- DVD-RW
- DVD+RW
- DVD+R
- DVD-ROM
- DVD-Video
- CD-R
- CD-RW
- CD
- LD
- MO
- MD
- iD
- Floppy disk
- Discs other than those with diameter of 8 cm
- CD-ROM

Note:

Discs recorded on PC or DVD video recorder may not be playable on this DVD video camera/recorder: If so, message "This disc cannot be used." will appear. Also, blue thumbnails will appear (Fig. 1* on page 24), or normal playback will not be possible.

HANDLING DISCS

● Using discs

DVD-RAM and DVD-R discs are very delicate recording media. Carefully read the following cautions and observe them:

- When using disc on this DVD video camera/recorder, be sure to keep it in Round DVD Holder.
- Always use a brand new disc when recording important material.
- Be sure not to touch the disc exposed portion, and be careful that no dirt adheres to it.
- If there is dust, scratch, dirt on disc or if it is warped, the following phenomena may occur:

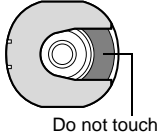

- Block noise in playback image
- Momentary stop of playback image
- Sound interrupted during playback, or abnormal sound



Block noise

- Blue thumbnail display* (Fig.1)
- Disc cannot correctly be recognized
- Delay between video and audio

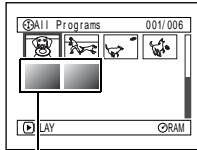

Fig. 1

Even if disc is normal, the above phenomena may occasionally occur. While the ACCESS/PC indicator is lit, do not subject disc to vibrations or impact, and avoid using DVD video camera/recorder at extremely high or low temperatures, or in environment where condensation is likely to occur.

- When recording images, the DVD video camera/recorder may avoid the portions of disc where recording is not possible, due to dust, scratches, etc.

[It will pause ●II at such a portion and automatically restart recording (●REC).]

(Recording one scene may produce multiple thumbnails.)

This will cause recording to be interrupted for several seconds to several minutes, and multiple thumbnails will be created by one recording session as shown above. In this case, the recordable time on disc will decrease.

- Be careful when removing the disc since the metal of removal slot of DVD video camera/recorder, and disc itself, may be hot.

● Storing discs

- When storing disc, insert it in Round DVD Holder into plastic case.
- Be careful that no condensation occurs on disc.
- Do not place disc in following places:
 - Direct sunlight for a long time
 - Where humidity is high or in dusty place
 - While there is heat from a heater, etc.

Note:

- See page 76 when cleaning the removed disc.
- See page 75 for how to handle disc removed from Round DVD Holder.
- See page 75 for how to set the disc removed from Round DVD Holder or another disc correctly in Round DVD Holder.

AVAILABLE CARDS

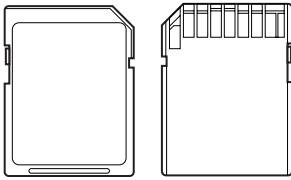

SD memory card and multimedia card can be used on this DVD video camera/recorder.

● Handling card

- Do not use cards other than the designated ones.
- Be sure to use a brand new Card when recording vital images.
- Do not touch the card terminal or allow it to touch metal.
- Do not paste anything other than exclusive label on label pasting portion.
- Do not subject card to impact, bend or drop it.
- Do not disassemble card or modify it.
- Do not expose card to water.
- Do not use or store card in the following places:
 - Where the temperature is high, such as in vehicle at high temperatures, under burning sun or near a heater.
 - Where humidity is high, or in dusty place
- When the erasure prevention switch on SD memory card is locked, no recording, deletion or editing will be possible on the card.

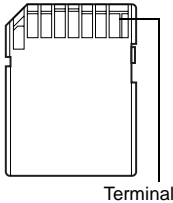

Terminal

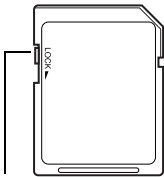

Erasure prevention switch

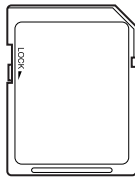

Locked status

- It is recommended that you create a backup file for valuable data on hard disk of PC.
- Do not do the following, or the data on card may be damaged or lost:
 - Do not remove the card or turn DVD video camera/recorder off during reading or writing of data
 - Do not use DVD video camera/recorder in a place subject to static electricity or electrical noise

Note:

- This DVD video camera/recorder can play back image data recorded on other digital cameras conforming to the DCF (Design rule for Camera File system) standard. The range of image data playable on this DVD video camera/recorder is that with pixels from 80 horizontal x 60 vertical to 4000 horizontal x 3000 vertical.
- DCF is an integrated image file format of digital cameras: Image files can be used on all digital devices conforming to DCF.
- Image data edited on PC and certain types of image data may not be visible on this DVD video camera/recorder.
- The image data recorded on another device may not be playable on this DVD video camera/recorder.

Storage Capacity on Disc or Card

RECORDABLE TIME OF MOVIE (VIDEO)

The recordable time will vary depending on the recording quality: See page 86 for the setting of recording quality.

Movie recordable time on one disc (on single side) (when recording only movies)

Recording quality	Disc used	
	DVD-RAM	DVD-R
XTRA	Approx. 18 min ^{*1}	No recording possible
FINE	Approx. 30 min ^{*2}	Approx. 30 min ^{*2}
STD	Approx. 60 min ^{*3}	Approx. 60 min ^{*3}
LPCM	No recording possible	Approx. 30 min ^{*4}

^{*1}: Variable bit recording (recording of more than 18 minutes may be possible because the transfer rate varies automatically between approx. 3-10 Mbps)

^{*2}: Transfer rate: Approx. 6 Mbps

^{*3}: Transfer rate: Approx. 3 Mbps

^{*4}: Linear PCM recording (If your DVD player does not conform to MPEG audio layer 2, record in LPCM mode)

Note:

- Audio in XTRA, FINE or STD mode is recorded in the MPEG audio layer 2 format, which is the option standard of DVD video standard.
- No movie can be recorded on SD memory card or multimedia card.
- The movie quality mode can be changed for recordings on DVD-RAM disc, but not on DVD-R disc.
- If you record in XTRA mode at high temperatures for a long time, the DVD video camera/recorder will get hot and the maximum transfer rate will be limited to approx. 6 Mbps.
- If a disc recorded in XTRA mode is used at high temperatures, normal playback may be impossible: Turn the DVD video camera/recorder off once, wait until the ambient temperature becomes lower, and then operate it again.

RECORDABLE STILLS (PHOTOS) ON DISC

● Number of recordable stills on one side of disc: Up to 999

If the disc still has free space after recording 999 stills on it, movies can also be recorded on it.

RECORDABLE STILLS (PHOTOS) ON CARD

The number of recordable stills will vary depending on the recording quality: See page 87 for the setting of recording quality.

For DZ-MV350A

Capacity	Recording quality		
	FINE	NORM	ECO
8 MB	Approx. 45	Approx. 95	Approx. 190
16 MB	Approx. 100	Approx. 200	Approx. 400
32 MB	Approx. 220	Approx. 440	Approx. 880
64 MB	Approx. 440	Approx. 880	Approx. 1,760
128MB	Approx. 880	Approx. 1,760	Approx. 3,520
256 MB	Approx. 1,760	Approx. 3,520	Approx. 7,040
512 MB	Approx. 3,520	Approx. 7,040	Approx. 14,080

For DZ-MV380A

Capacity	Recording quality		
	FINE	NORM	ECO
8 MB	Approx. 8	Approx. 14	Approx. 20
16 MB	Approx. 22	Approx. 35	Approx. 50
32 MB	Approx. 50	Approx. 80	Approx. 110
64 MB	Approx. 100	Approx. 160	Approx. 220
128MB	Approx. 200	Approx. 320	Approx. 440
256 MB	Approx. 400	Approx. 640	Approx. 880
512 MB	Approx. 800	Approx. 1,280	Approx. 1,760

(The numbers of recordable stills above are only for reference)

Note:

- Cards used on other devices can be used on this DVD video camera/recorder.
- No movie or music data recorded on card can be checked, viewed or heard on this DVD video camera/recorder. In addition, no such a data file can be displayed on this DVD video camera/recorder.
- Use the remaining display function to check the remaining free space on disc before use. See "Verifying Remaining Free Space on Disc or Card (Capacity)" on page 126.
- Some still data recorded on this DVD video camera/recorder may not be playable on another device.

● Still recording quality

The pixel size of JPEG stills that can be recorded on this DVD video camera/recorder is as follows:

Model	Setting	
	Camera input	External input
DZ-MV350A	640 × 480 pixels	640 × 480 pixels
DZ-MV380A	1,280 × 960 pixels	640 × 480 pixels

Although still images are recorded on DVD-RAM disc only in the FINE mode, the quality mode can be chosen when recording stills on card.

The following table shows the file size and quality of one JPEG still recorded on card:

Quality	File size		Application
	DZ-MV350	DZ-MV380	
FINE	Approx. 128 KB	Approx. 512 KB	When image quality is prioritized
NORM	Approx. 64 KB	Approx. 384 KB	Standard
ECO	Approx. 32 KB	Approx. 256 KB	When number of stills is prioritized (quality will be slightly inferior)

* See page 164 for the number of recordable stills.

Note:

No still can be recorded on DVD-R disc.

Features of DVD Video Camera/Recorder

VERSATILE FUNCTIONS AVAILABLE

This DVD video camera/recorder has numerous useful functions. However, the functions that can be used will vary depending on whether DVD-RAM disc, DVD-R disc or card is used.

Use the functions, following the table below:

Camera Functions:

Function		Disc/Card used			Reference page
		DVD-RAM	DVD-R	CARD	
Camera Functions Setup	Program AE	∴	∴	∴	80
	White Bal.	∴	∴	∴	81
	EIS	∴	∴	×	83
	Dig.Zoom	∴	∴	∴	84
	MIC.Filter	∴	∴	×	85
Record Functions Setup	VIDEO Mode	∴ ^{*1}	∴ ^{*2}	×	86
	Quality	×	×	∴	87
	Input Source	∴	∴	∴	88
	PHOTO Input	∴	×	∴	88
	Self Timer	∴	×	∴	89
	OSD Output	∴	∴	∴	90
Date Setup	Date Mode	∴	∴	∴	49
	Date Set	∴	∴	∴	48
LCD Setup	Brightness	∴	∴	∴	91
	Color Level	∴	∴	∴	91
Initial Setup	Beep	∴	∴	∴	92
	Power Save	∴	∴	∴	92
	Record LED	∴	∴	∴	93
	Language	∴	∴	∴	93
	Demo Mode	∴	∴	∴	146
	Reset	∴	∴	∴	94

∴: Available; ×: Unavailable
 (*1 Except for LPCM mode)
 (*2 Except for XTRA mode)

Disc Navigation Functions:

Function			Disc used		Reference page
			DVD-RAM	DVD-R	
Scene	Delete		∴	x	101
	Edit	Thumbnail	∴	x	103
		Skip	∴	x	104
		Fade	∴	x	105
		Combine	∴	x	107
		Divide	∴	x	108
		Move	∴	x	106, 123
		Copy		∴	x
	Select	Start → Current	∴	∴	112
		Current → End	∴	∴	112
		All	∴	∴	112
	Detail		∴	∴	113
	PlayList	Switch		∴	x
Play		∴	x	119	
Create		∴	x	117	
Edit		∴	x	120 - 123	
Title		∴	x	124	
Delete		∴	x	124	
Program	Switch		∴	∴	114
	Play		∴	∴	115
	Title		∴	x	115
Go To	Top		∴	∴	125
	End		∴	∴	125
Disc	Capacity		∴	x	126
	Protect Disc		∴	x	126
	Format Disc		∴	x	127
	Update Control Info.		∴	x	128
	Finalize Disc		x	∴	129
Others	Category	All	∴	x	130
		VIDEO	∴	x	130
		PHOTO	∴	x	130
	Repeat Play	On	∴	∴	130
		Off	∴	∴	130

∴: Available; x: Unavailable

Card Navigation Functions:

Function		Reference page	
Scene	Delete	101	
	Lock	110	
	DPOF	111	
	Select	Start → Current	112
		Current → End	112
		All	112
Detail	113		
Go To	Top	125	
	End	125	
Card	Capacity	126	
	Format Card	127	
Slide Show	All	131	
	DPOF	131	

RECORDING ON DISC

You can use both 8 cm DVD-RAM and DVD-R discs on this DVD video camera/recorder for recording. The recorded video and audio will be stored on an 8 cm DVD-RAM disc or 8 cm DVD-R disc.

Using disc allows you to record without overwriting previous recordings, and also to store your valuable recordings for as long as need be while retaining clarity.

With disc you can immediately access recording and playback, in contrast to videotape, which must be fast-forwarded or rewound.

In addition, simply loading a DVD-RAM disc into a PC equipped with DVD-RAM drive and DVD video recording software compatible with 8 cm DVD-RAM allows you to easily view the recorded disc.

You can finalize a recorded DVD-R disc on this DVD video camera/recorder so that you can play it back on a DVD player or DVD video recorder that is compatible with 8 cm DVD-R disc (however, the finalized DVD-R disc may not be usable on some DVD players).

RECORDING MOVIE AND STILL

The DVD video camera/recorder can record movies of events and sports, in the same way as with conventional camcorders.

It can also record stills on a DVD-RAM disc or card, as with a digital still camera. With CCD of 680,000 pixels (DZ-MV350A), 1,020,000 pixels (DZ-MV380A), high-quality movies and stills (on DVD-RAM disc only) can be recorded. When recording movies, subject images can be zoomed up to 240

times; when recording stills, subject images can be zoomed up to 40 times. Movies and stills can be recorded on the same disc, by simply switching the recording mode (power switch). However, if you use a DVD-R disc, a still image cannot be recorded. (If the DVD video camera/recorder is connected to PC, the DVD video camera/recorder can capture still images, such as JPEG data.)

IMMEDIATE REVIEWING OF RECORDED IMAGE

You can check the recorded movie or still in the viewfinder or on the LCD screen.

EDITING IN VARIOUS WAYS ON DVD VIDEO CAMERA/RECORDER ALONE

This DVD video camera/recorder is provided with a useful editing/playback tool. Disc Navigation allows you to easily attach a title or special video effect to the recorded movie or still. With Disc Navigation, you can arrange the playback order

and edit multiple images to play them back continuously. You can create an entire movie on this DVD video camera/recorder alone, without inputting video to a PC for editing.

USING WITH VARIOUS DEVICES

Connect this DVD video camera/recorder to your TV and you can enjoy the playback picture with your family and friends on the large TV screen; or connect it to a video printer (generally available) to

print the recorded image. You can also transfer recorded movies and stills (for DVD-RAM disc or card) to PC.

Setups

This section explains preparations for recording - setting up the DVD video camera/recorder and battery.

Setting Up the DVD Video Camera/Recorder

HOLDING DVD VIDEO CAMERA/ RECORDER

Insert your right hand from the bottom of DVD video camera/recorder up to the base of your thumb.

Put your hand in a position where you can easily operate the REC button and the Zoom lever.

Adjust the length of hand strap so that the DVD video camera/recorder is stable when you press the REC button with your thumb.

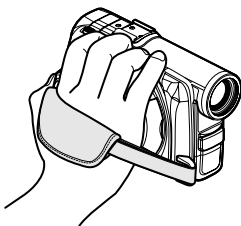

Caution:

Do not lift the DVD video camera/recorder by holding the viewfinder or LCD monitor. If the viewfinder or LCD monitor comes off, the DVD video camera/recorder will fall.

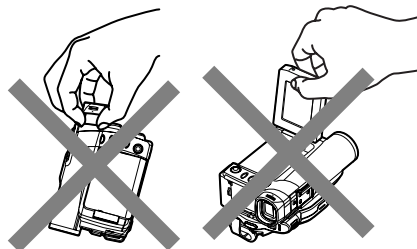

Note:

Do not adjust the hand strap while holding the DVD video camera/recorder: Doing this could cause the DVD video camera/recorder to fall and be damaged.

ATTACHING LENS CAP

Pass the provided string through the hole in the lens cap and attach it to the hand strap of DVD video camera/recorder.

1 Use the string to attach the cap to the DVD video camera/recorder.

2 Push the both sides of cap inward and attach it over the lens.

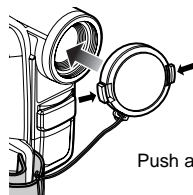
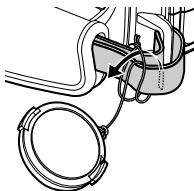
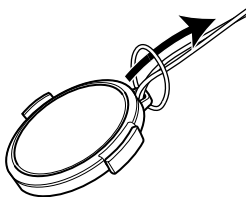

Push and fit

Note:

- Always keep the lens cap on when not using the DVD video camera/recorder, to protect the lens.
- When recording, attach the lens cap to the hand strap by hooking the tab inside the cap onto strap for comfortable shooting.

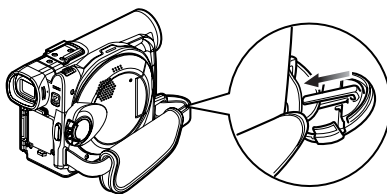

ATTACHING SHOULDER STRAP

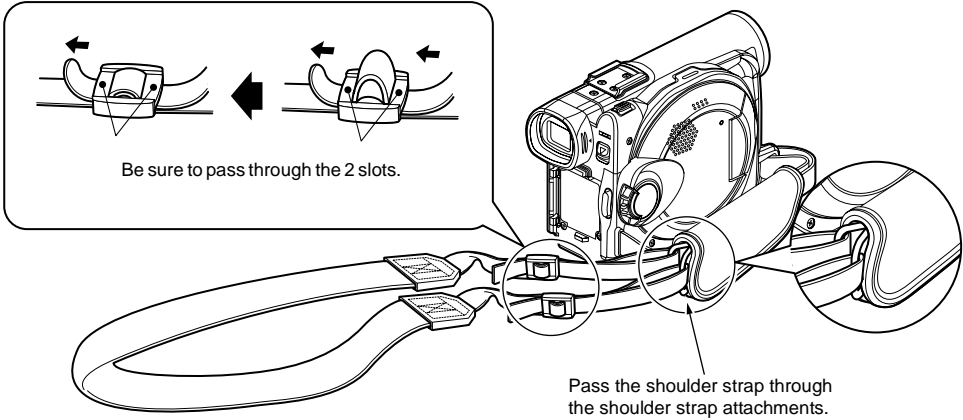

INSERTING BATTERY INTO REMOTE CONTROL

Insert the provided lithium battery into remote control.

1 Slide the cover to remove it.

2 Insert the lithium battery with the positive ⊕ terminal facing up.

3 Slide the cover to close it.

Note:

The life of lithium battery is approximately one year. If the battery is discharged, no operation is possible with remote control: Replace the battery.

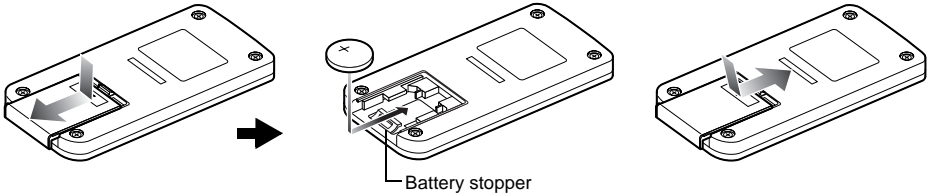

REMOVING BATTERY FROM REMOTE CONTROL

1 While pushing the battery stopper, slide the battery out.

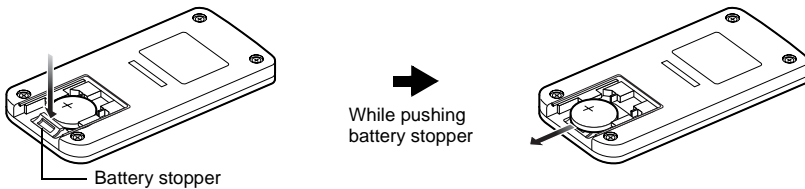

Warning:

- KEEP THE BATTERY AWAY FROM CHILDREN AND PETS.
- IF SWALLOWED CONSULT A PHYSICIAN IMMEDIATELY FOR EMERGENCY TREATMENT.
- BATTERY MAY EXPLODE IF NOT HANDLED PROPERLY. DO NOT RECHARGE, DISASSEMBLE OR DISPOSE OF IN FIRE.

Note:

- Replace the battery with a Hitachi Maxell, Sony, Panasonic, Sanyo, Toshiba CR2025, or Duracell DL2025. Use of another battery may present a risk of fire or explosion.
- Dispose of battery safely in accordance with local laws. Do not dispose of in fire.
- Do not short circuit the battery.
- Do not hold the battery with the metallic tweezers.
- Keep the battery in a dark, cool, dry place.

● Using Remote Control

Point the remote control to the infrared receiver on the DVD video camera/recorder. The remote controllable distance is up to 16 feet (5 m).

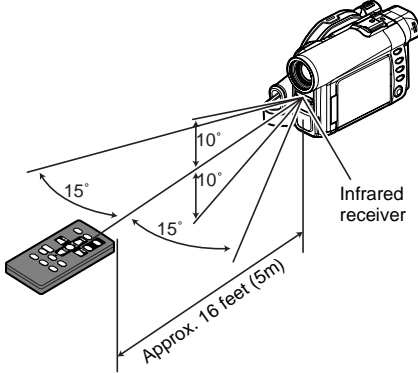

Note:

- When using the remote control, make sure that the infrared receiver on DVD video camera/recorder is not exposed to direct sunlight or any intense light. If the infrared receiver is subject to light stronger than the infrared light from remote control, the DVD video camera/recorder cannot be operated by remote control.
- If there is an obstacle between the remote control and infrared receiver on DVD video camera/recorder, remote control may not be possible.
- The DVD video camera/recorder uses the "VCR2" remote control code of Hitachi VCRs. If you use a Hitachi VCR, etc. with remote control code set to "VCR2", a VCR placed near the DVD video camera/recorder will also be operated by the remote control: To prevent this, change the remote control code of the VCR.

Setting Up the Battery

The DZ-BP14S battery provided with this DVD video camera/recorder has not been charged at purchase time: Charge it before using the DVD video camera/recorder.

Note:

- Be sure to use the DZ-BP14SW battery for the DVD video camera/recorder: Using other batteries could cause the DVD video camera/recorder to malfunction, or result in fire.
- Be sure to use the DZ-ACS1 AC adapter/charger to charge the battery: Using other chargers could cause electric shock or fire.
- Charge the battery at temperatures of 50 - 86°F (10-30°C).

CHARGING BATTERY

Use the provided AC adapter/charger to charge the battery.

1 Connect the power cable to AC adapter/charger.

2 Plug the power cable into AC outlet.

3 Attach the battery to AC adapter/charger.

Note:

When charging a battery, unplug the DC power cord from the DC output jack on AC adapter/charger.

The CHARGE indicator on AC adapter/charger will light.

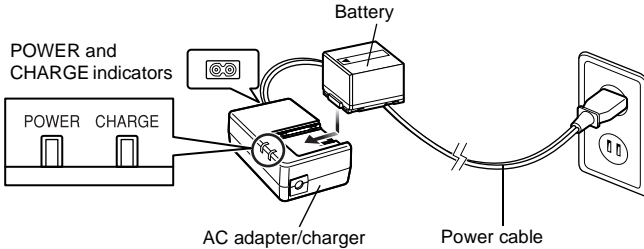

● Battery charged status

You can find out the charged status of battery by checking the CHARGE indicator on AC adapter/charger:

Charge status	CHARGE indicator
During charge	Lit
Charge complete	Goes out

Note:

See "Troubleshooting" on page 156 when the CHARGE indicator blinks.

ATTACHING BATTERY TO DVD VIDEO CAMERA/RECORDER

- 1 Fit the battery to the battery attachment platform on this DVD video camera/recorder and slide it upward until a click is heard.

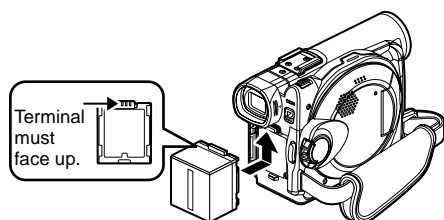

Note:

- Make sure that the battery is in the correct orientation.
- Make sure that the battery is securely attached: Incomplete attachment could cause the battery to fall, resulting in damage.

REMOVING BATTERY

After using the DVD video camera/recorder, remove the battery from it.

- 1 Slide the BATTERY EJECT switch on the bottom of DVD video camera/recorder: The battery can be removed.

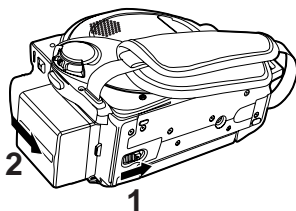

Note:

- For safety, be sure to turn the DVD video camera/recorder off before attaching or removing the battery.
- Be careful not to drop the removed battery.
- If the battery remains attached, minute level current will flow even if the DVD video camera/recorder is off, and the battery will discharge.

● **Recordable time with fully charged battery (with no zoom operation, etc.)**

The reference for DVD video camera/recorder recordable time with fully charged battery is between 40 and 60 minutes.

For DZ-MV350A

Video quality mode		DVD-RAM disc	DVD-R disc
XTRA ^{*1}	When using viewfinder	approx. 125 min	—
	When using LCD monitor	approx. 100 min	—
FINE	When using viewfinder	approx. 125 min	approx. 125 min
	When using LCD monitor	approx. 100 min	approx. 100 min
STD	When using viewfinder	approx. 145 min	approx. 145 min
	When using LCD monitor	approx. 115 min	approx. 115 min
LPCM ^{*2}	When using viewfinder	—	approx. 125 min
	When using LCD monitor	—	approx. 100 min

For DZ-MV380A

Video quality mode		DVD-RAM disc	DVD-R disc
XTRA ^{*1}	When using viewfinder	approx. 115 min	—
	When using LCD monitor	approx. 95 min	—
FINE	When using viewfinder	approx. 115 min	approx. 115 min
	When using LCD monitor	approx. 95 min	approx. 95 min
STD	When using viewfinder	approx. 135 min	approx. 135 min
	When using LCD monitor	approx. 105 min	approx. 105 min
LPCM ^{*2}	When using viewfinder	—	approx. 115 min
	When using LCD monitor	—	approx. 95 min

*1 The XTRA mode can be set only when a DVD-RAM disc is used. The time is only for reference: It will vary depending on recording contents.

*2 LPCM mode can be set only when DVD-R disc is used.

Without any extraordinary operation, such as zooming:

The continuously recordable time of DVD video camera/recorder in the above table shows the time available when the DVD video camera/recorder is in the recording mode without using any other function after recording is started. In actual recording, the battery will discharge 2-3 times faster than this reference, since the REC button and zoom are being operated, and playback is performed. Assume that the recordable time with a fully charged battery is between 40 and 60 minutes, and prepare the number of batteries to allow for the time you are planning to record on the DVD video camera/recorder.

Note that the battery discharges faster in cold places.

● **The time taken for charging the battery is 165 minutes at 77°F (25°C).**

Note:



- See page 156 when charging is not possible.
- The charge time will vary depending on the battery remaining level.
- During and after charging, the battery will be warm, but this does not indicate a fault.
- If the following phenomena appear, the battery may be dead: Replace it.
 - Charging does not start within 10 seconds (the CHARGE indicator does not light).
 - The battery cannot be charged up to 75% if more than 9 hours has elapsed after charging started.
 - The battery cannot be fully charged if more than 5 hours has elapsed after it was charged to 75%.
- Charge the battery at ambient temperature 50°F to 86°F (10°C to 30°C): Charging at temperatures other than this range could damage the battery.

BATTERY REMAINING LEVEL INDICATOR

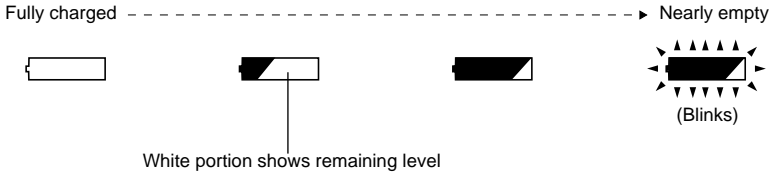
When the battery is used to power the DVD video camera/recorder, the battery remaining level appears in the viewfinder or on the LCD screen as follows:



Note:

The remaining level indicator “” may be displayed for an extended period, and “” or “” may be displayed for a shorter period.

EFFICIENT USE OF BATTERY

Charge battery immediately before using DVD video camera/recorder:

The battery will slightly discharge even if it is detached from the DVD video camera/recorder. If the battery is left attached to DVD video camera/recorder, it will consume a slight amount of power. Therefore, it is recommended that you charge the battery shortly before using the DVD video camera/recorder, usually on the day before you plan to use it.

However, since the battery used for this DVD video camera/recorder is free from the memory effect, you do not need to completely discharge the battery before charging it.

When not using the DVD video camera/recorder for an extended period:

It is recommended that you fully charge the battery once a year, attach it to DVD video camera/recorder and use it up; then remove the battery and store it in a cool place again.

Store in cool, dark place:

When you are not using the DVD video camera/recorder, remove the battery and store it in a cool, dark place. If you store it in a place where the temperature is high, the battery life will be shortened. Be especially sure not to store the battery in an environment (in a closed vehicle) over 140°F (60°C): Neglecting this could damage the battery.

Battery life:

The battery life varies greatly depending on the ambient environment and how often the DVD video camera/recorder is used. If the usable time of DVD video camera/recorder with a fully charged battery is noticeably short, the battery is probably dead: Purchase a new one.

Power save and discharge of battery:

It is recommended that you turn the DVD video camera/recorder off in status other than recording, since even during recording pause battery power is consumed at the same level as during recording. If, when you specify Power Save On, the recording pause status continues for approximately 5 minutes, the DVD video camera/recorder will automatically turn off.

To set or release power save, see “Turning DVD Video Camera/Recorder Off Automatically (Power Save)” on page 92.

USING DVD VIDEO CAMERA/RECORDER WITH AC ADAPTER/CHARGER

It is recommended that you use the AC adapter/charger to power the DVD video camera/recorder from household AC outlet when you perform settings on it, play back or edit images, or use it indoors.

Note:

Be sure to use the specified AC adapter/charger (DZ-ACS1) to power the DVD video camera/recorder. Using other AC adapter/chargers could cause electric shock or result in fire.

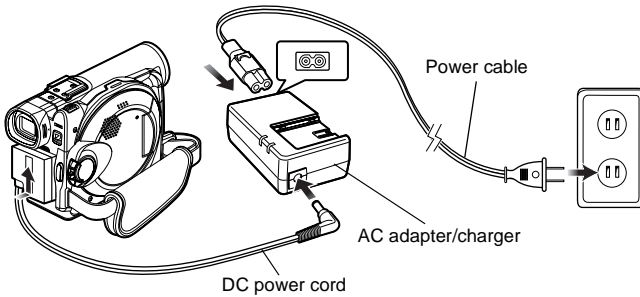

- 1 Connect the power cable to AC adapter/charger.
- 2 Plug the power cable into AC outlet.
- 3 Plug one end of DC power cord into the DC output jack on AC adapter/charger.
- 4 Attach the other end of DC power cord to the battery attachment platform on DVD video camera/recorder.

Note:

- The AC adapter/charger can be used around the world. An AC plug adapter is required in some foreign countries. If you need one, purchase it from your Hitachi distributor.
- If the CHARGE indicator does not light when the AC adapter/charger is plugged into AC outlet, unplug it from the AC outlet, wait a few moments, and then plug it into the AC outlet again. If the CHARGE indicator still does not light, the AC adapter/charger may be faulty. Unplug it from the AC outlet and consult your dealer.

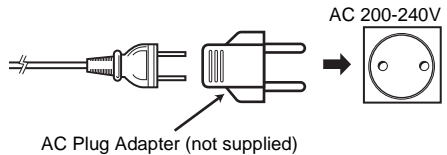

Inserting and Removing Disc

INSERTING DISC

- 1 Press down the DISC EJECT button once and release it.

A few moments after the ACCESS/PC indicator blinks, the cover of disc insertion block will open slightly.

- 2 Gently open the cover by hand until it stops.
- 3 Insert the disc, in Round DVD Holder, into the disc guide until it stops.

Note that the recording/playback surface of disc must face the inside of DVD video camera/recorder. The orientation for inserting the disc into the disc guide is also predetermined: Load the disc correctly, referring to the figure below.

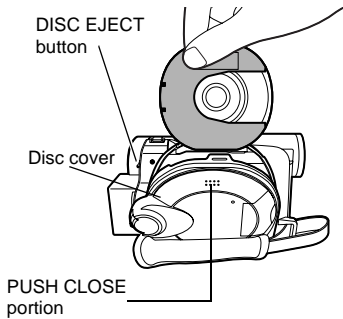

- The disc exposed portion must face in the same direction as the lens, as shown in figure.
- The recording/playback side must face the inside (DVD video camera/recorder).

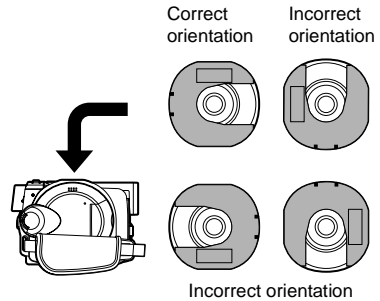
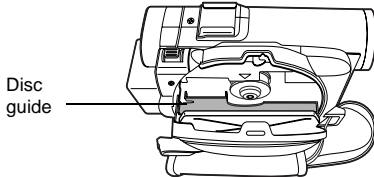

- 4 Push the section marked "PUSH CLOSE" on the cover of disc insertion block, to close the cover.
- 5 Turn the DVD video camera/recorder on (VIDEO or PHOTO).

When "DISC ACCESS" disappears, the DVD video camera/recorder is ready for recording.

● Identifying recording/playback sides of disc:

Single sided disc:

The recording/playback side is opposite to the printed label.

Double-sided disc:

The recording/playback side of "SIDE A" is opposite to the "SIDE A" marked side.

The recording/playback side of "SIDE B" is the "SIDE A" marked side.

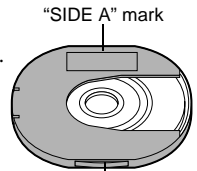

The opposite side is the "SIDE A" recording/playback side.

Note:

- Disc cannot be inserted or removed unless the battery or AC adapter/charger is connected to DVD video camera/recorder.
- See page 76 for how to set disc in Round DVD Holder.
- If there is some delay before recording starts, refer to page 147.
- The disc insertion orientation is predetermined: Forcibly inserting a disc in wrong orientation could damage the DVD video camera/recorder or Round DVD Holder of disc.
- If the disc is not correctly inserted, the cover will not close. Never try to forcibly close the cover: This could cause damage. Reinsert the disc properly.
- If a single-sided disc is inserted into DVD video camera/recorder with the printed label facing the inside, an error message will appear. Remove the disc and reinsert it with its recording/playback side facing the inside. See "Trouble Messages" on page 149.

●When using brand-new DVD-R disc

Recognition of the disc will start.

The messages on the right will appear in sequence by pressing the ►/|| button between messages.

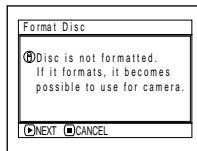
**When recording on this DVD video camera/recorder:**

When final message "Format the disc now?" appears, choose "YES" and then press the ►/|| button.

The disc will be automatically formatted.

When formatting is complete, "DVD-R disc, Video mode cannot be changed" will appear (See page 152): Press the ►/|| button to erase the message.

Once formatted, a DVD-R disc can no longer be changed to a disc for PC, even if it has not been recorded on this DVD video camera/recorder.

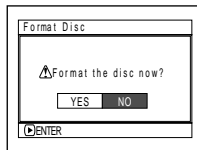
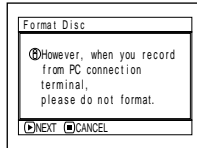
**Note:**

See page 86 for movie quality mode.

When recording data from PC:

While the above messages are being displayed, press the □ button, or when message "Format the disc now?" appears, choose "NO" and then press the ►/|| button.

However, if data from PC has not yet been recorded, the disc can be made usable on this DVD video camera/recorder. When inserting the disc into this DVD video camera/recorder, the same message will appear: If you wish to use it on this DVD video camera/recorder, choose "YES".

Note:

Do not initialize a disc on which you wish to record data created using the application (MyDVD) of PC.

REMOVING DISC

- 1 Set the power switch to "POWER OFF" to turn the DVD video camera/recorder off.

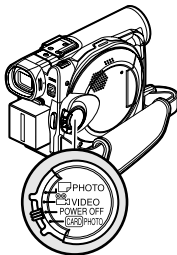

- 2 Press down the DISC EJECT button once and release it.

In a moment, the cover of disc insertion block will open slightly.

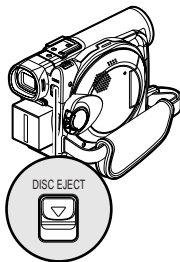

- 3 Gently open the cover until it stops.

When the cover is fully open, the disc will slightly come out from the disc guide, and stop.

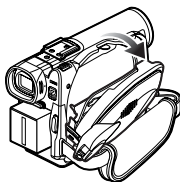

- 4 Remove the disc.

Hold the top of Round DVD Holder as shown in the illustration and gently pull it out.

Hold disc around this portion.

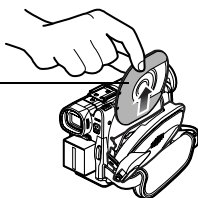

Note:

Be careful not to touch the disc exposed portion when removing the disc.

- 5 Gently push the section indicated "PUSH CLOSE" on the cover of disc insertion block, to close the cover.

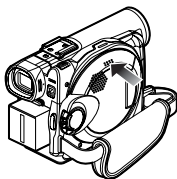

Note:

- It is recommended that you turn the DVD video camera/recorder off when inserting or removing disc, in order to prevent faulty operation.
- Even after the DVD video camera/recorder is turned on, the disc can be removed unless it is in recording status. Hold down the DISC EJECT button for approximately 2 seconds, and then release it to remove the disc. (The DISC EJECT indicator on the LCD screen will blink.) It is recommended that you turn the DVD video camera/recorder off before inserting or removing disc to prevent misoperation.
- Do not detach the battery or AC adapter/charger until the DVD video camera/recorder is completely turned off.
- Do not insert anything other than the 8 cm DVD-RAM or DVD-R disc into the disc insertion block: Doing so could cause malfunctions.
- Set the power switch to "POWER OFF" to turn the DVD video camera/recorder off.
- When inserting or removing the disc, be careful not to touch the inside of DVD video camera/recorder (especially, the lens of laser pickup).
- When inserting or removing the disc, connect a charged battery or AC adapter/charger to the DVD video camera/recorder: The disc cover will not open unless the DVD video camera/recorder is powered.

Inserting and Removing Card

Before inserting or removing card, set the power switch to "POWER OFF" to turn the DVD video camera/recorder off.

- 1** Open the cover of card insertion block with power turned off.

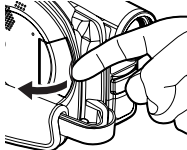

- 2** Insert card with its terminal inward until it locks.

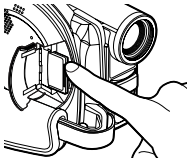
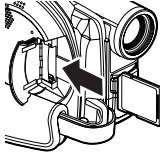

- Removing Card**
Push the center of card edge: The card will come out so that it can be held by fingers.

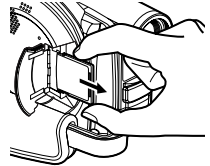
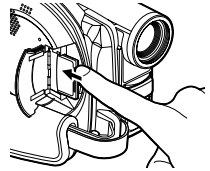

- 3** Close the cover of card insertion block.

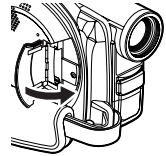

Basic Techniques

This section explains about recording of movies and still images, and also basic settings on DVD video camera/recorder.

Basic Handling of DVD Video Camera/Recorder

TURNING DVD VIDEO CAMERA/RECORDER ON AND OFF

While holding down the red button at the center of power switch, set the switch according to each recording function:

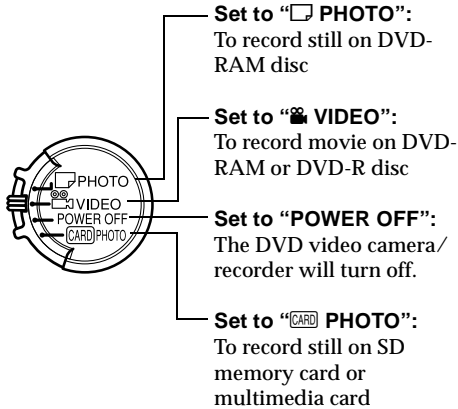

Power ON status

During playback, set the power switch to "VIDEO" or "PHOTO" when using disc, or set it to "CARD PHOTO" when using card.

Turn the switch while holding down the red button at the center of switch.

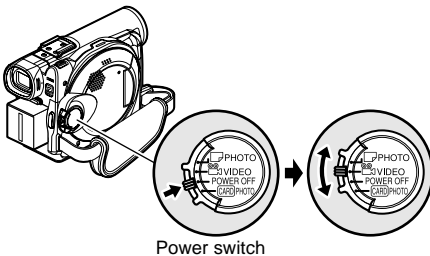

Note:

- Once you turn the DVD video camera/recorder on to let it recognize the disc, you can immediately record or play back by turning the DVD video camera/recorder on again. However, if you remove the disc, replace it, or if the date changes after power is turned on, it will take some time for the DVD video camera/recorder to start because it must recognize the disc again (See page 147).
- It will take some time for the DVD video camera/recorder to display the Disc navigation screen after power is turned on.
- If you turn the DVD video camera/recorder on, the ACCESS indicator will light or blink to show that the DVD video camera/recorder is recognizing the disc or card: During this time, no operation, such as recording, can be performed. After several seconds, the ACCESS indicator will go out, and operating the DVD video camera/recorder will be possible.

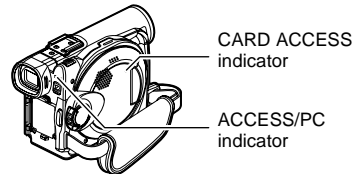

- When the DVD video camera/recorder is turned on, the self-diagnosis function will work and a message may appear. In this case, refer to "Trouble Messages" on page 149 and take corrective action.
- While the ACCESS/PC or CARD ACCESS indicator is lit or blinking, do not violently open or close the LCD monitor.

VIEWING SUBJECT THROUGH VIEWFINDER

- 1 Pull out the viewfinder.
- 2 Turn the diopter control knob to adjust the focus to suit your eyesight.

Note:

- If the LCD monitor is open approximately 90°, the viewfinder will be off.
- Focusing will not be correct unless the viewfinder is pulled out.

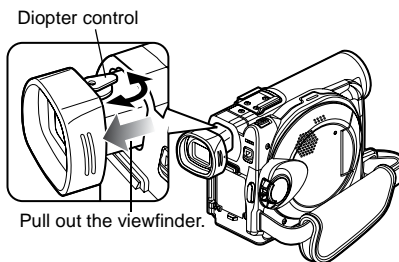

VIEWING IMAGE ON LCD MONITOR SCREEN

If you open the LCD monitor, you can monitor subject image on the LCD screen.

- 1 Open the LCD monitor.

The LCD monitor has a portion where you can hook your finger. Hook the finger there to open the monitor.

● Range where the LCD monitor can be moved

The LCD monitor can be opened up to approximately 90°.

If the LCD monitor is open 90°, it can be tilted with the screen down as much as 90°, and can also be tilted with screen up and turned up to 180° so the screen faces in the same direction as the lens.

If the LCD monitor is turned 180° so the screen faces in the same direction as the lens during recording, subject image will also appear in the viewfinder as an mirror image (left/right reversed).

Tilt the LCD monitor to adjust its vertical angle so that you can see the screen easily.

Note:

- Be sure to open the LCD monitor approximately 90° before changing its vertical angle.
- Do not record for a prolonged time with the LCD monitor turned approximately 180° in close contact with the DVD video camera/recorder body: Doing this could cause the DVD video camera/recorder and LCD monitor to become hot.

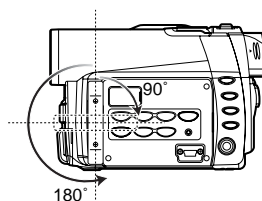
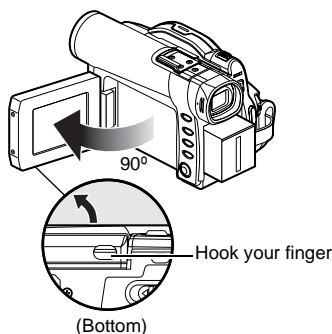

CLOSING LCD MONITOR

Before closing the LCD monitor, be sure to reset it at right angles to the DVD video camera/recorder.

Replace the LCD monitor on the DVD video camera/recorder with the LCD screen facing inward until a click is heard.

Note:

- Be sure to return the LCD monitor at right angles to the DVD video camera/recorder before closing it or replacing it on the DVD video camera/recorder with its screen facing outside. If the LCD monitor is tilted, it cannot be closed to the DVD video camera/recorder.
- If the LCD monitor is not securely locked to the DVD video camera/recorder, no image will appear in the viewfinder.

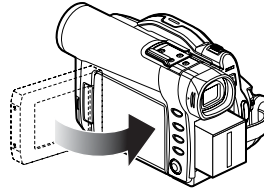

Setting Date and Time

Set the current date and time so that the date and time you make a recording can be recorded correctly. The following procedure can also be used to correct the date and time you have already set.

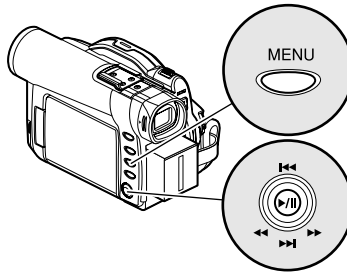

Tilt up/down and to left/right to select, and then press **▶/||** to designate.

1 Turn the DVD video camera/recorder on.

2 Press the MENU button.

The menu screen will appear.

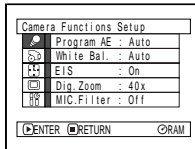

3 Use the joystick to choose "Date Setup" and then "Date Set".

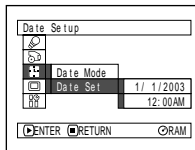

4 Tilt the joystick to right.

The figure for the month will be selected. [The digit that is highlighted first depends on the date display format

(set up in Date Mode): The digit on the left end of the date display will be first highlighted.]

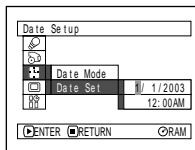

Note:

After setting the figure for the month, tilt the joystick to right to select the digit to be set. If you press the **▶/||** button after selecting the figure for the month, the screen for verifying the set date will appear instead of screen for setting day, year or time.

5 Tilt the joystick to left or right to select the digit you want to set in sequence.

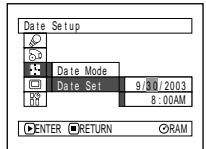

Tilt the joystick up or down to select the number for current date/time, and then repeat step 5 to set the current date and time.

Note:

To stop date/time setting midway, press the **□** button.

6 After setting the current date and time, press the **▶/||** button.

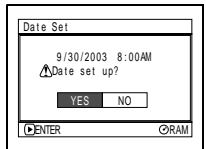

The screen for verifying the set date will appear.

7 If the displayed date and time are correct, use the joystick to choose "YES", and then press the **▶/||** button.

The date and time will be set, and the DVD video camera/recorder will enter the recording pause status.

Choosing "NO" will restore the menu screen.

Note:

This DVD video camera/recorder incorporates a rechargeable battery to store the date and time in memory. If this built-in battery is exhausted, the date and time will be reset. To prevent this, connect the AC adapter/charger to DVD video camera/recorder every 3 months, and leave them for at least 24 hours with the DVD video camera/recorder turned off: The built-in battery will be charged.

CHANGING DISPLAY FORMAT OF DATE AND TIME

You can select one of three date display formats: month/day/year, day/month/year or year/month/day. Associated with the selected date display, the time display format will also change as follows:

Display format	Example of display
M/D/Y	5:00PM 9/30/2003
D/M/Y	17:00 30/9/2003
Y/M/D	PM5:00 2003/9/30

1 Press the MENU button.

The menu screen will appear.

2 Use the joystick to choose “Date Mode” on the “Date Setup” menu screen, and then press the ►/II button.

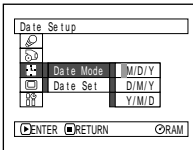

The options will appear on the right of “Date Mode”: The mark will be attached to the currently selected option.

3 Use the joystick to select the desired date display format, and then press the ►/II button.

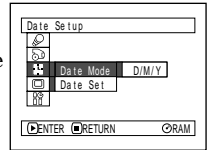

The menu screen for setting date will be restored, and the “Date Mode” has been changed as you designated.

4 Press the MENU button to switch off the menu screen.

Note:

If the date display format has been changed, the display format during playback as well as during recording will also be changed (See page 62).

Recording Movie

Insert a recordable DVD-RAM or DVD-R disc into this DVD video camera/recorder.

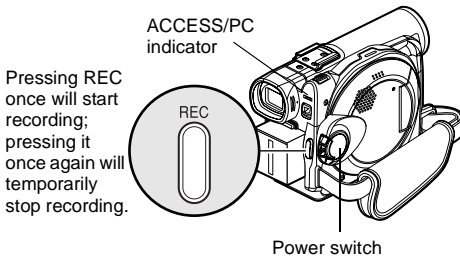

Pressing REC once will start recording; pressing it once again will temporarily stop recording.

1 Turn the DVD camera/recorder on.

Set the power switch to “**VIDEO**” to turn the DVD video camera/recorder on. After the ACCESS/PC indicator goes out, perform the subsequent operation:

2 Check the subject on the screen (viewfinder or LCD).

If using the viewfinder, pull it out.

3 Press the REC button.

The “●II” mark in the viewfinder or on the LCD screen will change to the “●REC” mark, and recording will start.

During recording, the recording indicator on the front of DVD video camera/recorder will light. Pressing REC again during recording will set the DVD video camera/recorder to the recording pause status.

4 When recording is finished, turn the DVD video camera/recorder off.

Note:

- See page 147 when recording movie is not possible.
- See page 147 if it takes some time before recording is possible.
- See page 62 for on-screen information display.
- It is recommended that you use DVD-RAM disc from which recorded contents can be deleted.
- Sound is recorded from the stereo microphone on the front of DVD video camera/recorder: Take care that this microphone is not blocked.
- You can press the REC button immediately after the DVD video camera/recorder enters the recording pause status, but no further recording can be made while “DISC ACCESS” is being displayed. Recording will restart after the message disappears.
- Take care that power is not interrupted while the ACCESS/PC indicator is blinking.
- The minimum recordable time of movie is approximately 3 seconds.
- See page 93 for setting of Record LED (recording indicator) On/Off.
- For various functions available during recording, see “Setting Up Camera Functions” on page 80.
- Hitachi cannot be responsible for video and audio that cannot be recorded or edited because of any defect.
- The power switch can be changed over even during recording, but the operation will not be changed.
- Each time the DVD video camera/recorder enters the recording pause status, the counter display will be reset to “0:00:00”.
- When using DVD-R disc, do not perform the following, or data on the disc may not be read:
 - Using another device, doing additional recording on DVD-R disc recorded on this DVD video camera/recorder
 - Using this DVD video camera/recorder, doing additional recording on DVD-R disc recorded on another device

● Power save and discharge of battery

If, when “Power Save: On” is specified, the DVD video camera/recorder is left in the recording pause status for approximately 5 minutes, it will automatically turn off.

To restart recording, set the power switch to “POWER OFF”, and then set it to “ VIDEO”.

To set or release power save, see “Turning DVD Video Camera/Recorder Off Automatically (Power Save)” on page 92.

It is recommended that you specify “Power Save: On”, since even during recording pause battery power is consumed at the same level as during recording. Especially when power save has been released, turn the DVD video camera/recorder off when not in use.

USING EXTERNAL MICROPHONE

Connect external microphone (generally available) to the external microphone jack of this DVD video camera/recorder. Clearer sound can be recorded. Turn on the switch on microphone and start recording. For details on microphone, see "Major Specifications" on page 164.

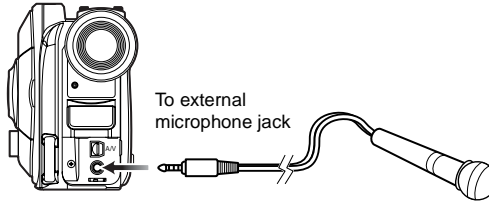

Note:

- If the AV/S input/output cable is plugged in, you cannot use external microphone: Unplug the AV/S input/output cable to use the external microphone.
- This DVD video camera/recorder cannot use a plug-in power type microphone (power supplied from camcorder).

● Attaching Ferrite Core

Although no ferrite core is attached in the illustrations of the cables in text, be sure to attach the provided core to the external microphone cable using the following procedure:

- 1 Open the cover of ferrite core.
- 2 Attach the core to external microphone cable at a position approximately 1-15/16" (5 cm) from its end.
- 3 Close the cover of core, taking care that it does not catch the external microphone cable.

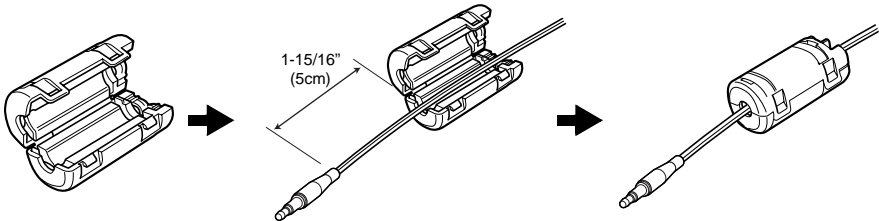

Recording Stills

Note:

Recording of still images is possible on DVD-RAM disc and card.

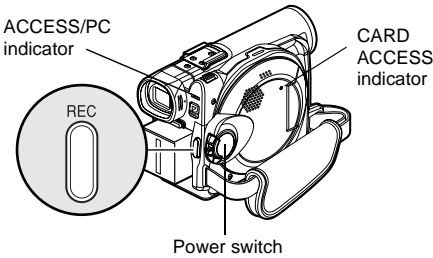

1 Turn the DVD camera/recorder on.

When using DVD-RAM disc:
Set the power switch to "☐ PHOTO".
When using card:
Set the power switch to "CARD PHOTO".

After the ACCESS indicator goes out, perform the subsequent operation:

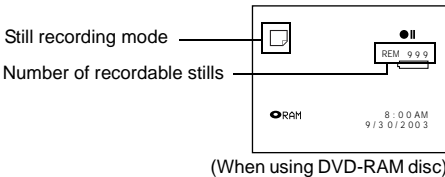

(When using DVD-RAM disc)

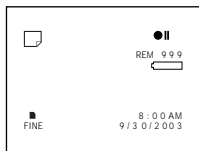

(When using card)

2 Check the subject on the screen (viewfinder or LCD).

3 Press the REC button.

The DVD video camera/recorder automatically focuses on the subject at the center of screen (when auto focus is selected).

The screen will be black, and then the recorded still will be displayed. When the "● II" mark appears, you can proceed with the next recording; while "DISC ACCESS" or "CARD ACCESS" is being displayed, you cannot proceed with the next recording.



4 Set the power switch to "POWER OFF" to turn the DVD video camera/recorder off.

Note:

- See "Still recording quality" on page 27 for details of stills on card.
- Do not operate the power switch or remove the card while the ACCCESS/PC or CARD ACCESS indicator is lit or blinking: Doing so may damage the card or the data on card.
- With DZ-MV380A, the range of screen in which recording is possible will be different for movie and still.

● Setting Video Flash* (see “Introduction to Optional Accessories” on page 166)

When recording stills in a dark place, or the subject is lit from rear, it is recommended that you use the optional DZ-FLH3 Video Flash: Refer to the instruction manual of Video Flash for use.

Setting of Video Flash	On-screen information	Manner of emitting light
AUTO	No display	Automatically emits light in dark place or in a place lit from rear.
ON		Always emits light regardless of brightness
OFF		No light emission

* Unusable on DZ-MV350A.

Note:

- The DVD video camera/recorder automatically sets the shutter speed between 1/800 and 1/30 second (between 1/800 and 1/10 second if Program AE has been set to Low Light) depending on the subject brightness.
- During recording of stills, the electronic image stabilizer will not function.
- See “Switching Quality of Still Image (Quality)” on page 87 if you want to change the still quality mode.
- However, dark subjects may not be in clear focus even if the Video Flash is used. It is recommended that you light a subject when recording in a dark place.

Zooming

This DVD video camera/recorder allows you to record using optical 10-power zoom and digital zoom.

Move the zoom lever to “T” control side, and the subject image will gradually become telescopic:
 Move the zoom lever to “W” control side, and the image will widen.

If Dig. Zoom 40× or 240× is specified, moving the zoom lever to “T” control side will engage the digital zoom midway (See page 84).

Note:

- The setting of digital zoom 240× is effective only during movie recording.
- If you set zoom to 240× when recording still, the digital zoom will be up to 40×.
- When a subject is zoomed, it may be momentarily out of focus.
- When digital zoom is engaged, the image quality will be rougher.
- If the zoom ratio is frequently changed at short intervals, the recorded image will be unclear.

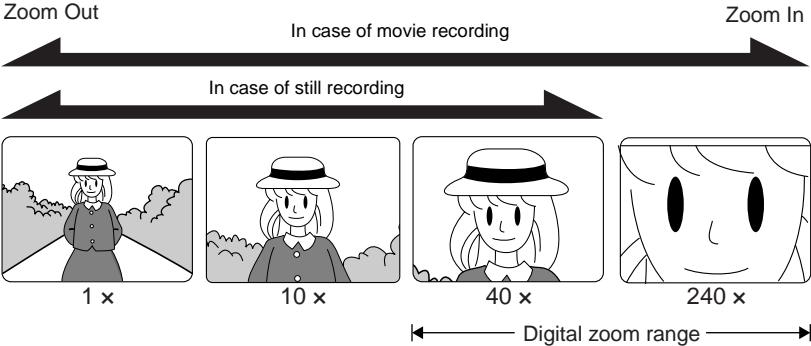
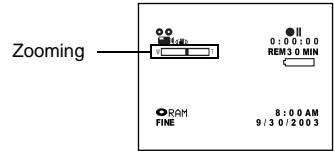
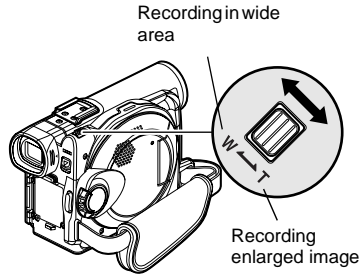

MACRO RECORDING

Use the macro function when recording a small object from close-up position: You can shoot the subject as close as approximately 13/16" (2 cm) from the lens surface, magnifying the image to fill the screen.

- 1 Aim the DVD video camera/recorder at the subject, and press down the zoom lever to "W" control side.

Note:

- Zoom can be used, but the subject may not be focused, depending on the distance to the subject. In this case, move the zoom to "W" control side to focus.
- The amount of light tends to be insufficient during macro recording: If the subject image is too dark, use additional lighting.

RECORDING SUBJECTS FOR STRONGER WIDE-ANGLE OR TELEPHOTO EFFECT

Use tele-conversion lens or wide-conversion lens to record subjects for stronger telephoto or wide-angle effect.

Use conversion lenses with the following filter diameters:

DZ-MV350A: 30.5 mm

DZ-MV380A: 37 mm

- 1 Remove the lens hood from DVD video camera/recorder.
- 2 Remove the cap of conversion lens, and screw the lens into the filter thread of DVD video camera/recorder until it stops.

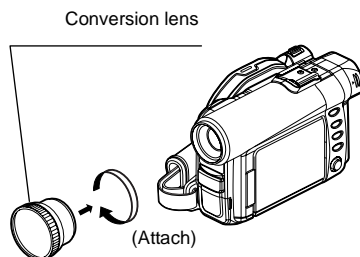
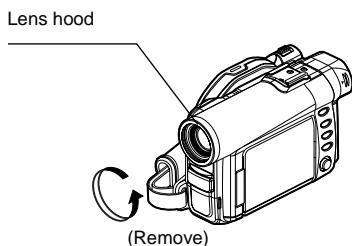

* With DZ-MV380A, you can use the optional conversion lenses:

- Tele-conversion lens (DZ-TL1): For stronger telephoto effect
- Wide-conversion lens (DZ-WL1): For stronger wide-angle effect

Note:

- Be careful not to lose the removed lens hood.
- With DZ-TL1 tele-conversion lens, the focusing range at "T" (telephoto) control side is between approx. 5 m and infinite.
- When a conversion lens is attached, note that if you zoom in on a subject, vignetting will slightly occur on the "W" (wide-angle) control side (the four corners of screen will be dim).

Manually Focusing Subject

The DVD video camera/recorder measures the distance to a subject viewed at the center of screen and automatically focuses on it. If it is difficult to automatically focus the subject, adjust the focus manually.

FOCUSING DURING RECORDING

This DVD video camera/recorder automatically focuses a subject at the center of screen (auto-focus). When the DVD video camera/recorder is turned on, auto-focus will always be set.

Focusing range

You can switch the display mode of on-screen information:

- On T (tele) side: approximately 3.6 feet (1 m) from lens surface to infinity
- On W (wide) side: approximately 13/16" (2 cm) from lens surface to infinity

1 Press the FOCUS button during recording.

"MF" will appear on the screen.

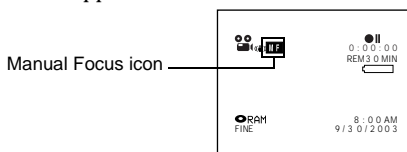

2 Press the zoom lever down to "T" control side to zoom in on subject.

3 Use the \ominus \oplus buttons to adjust the focus, while viewing the image in the viewfinder or on the LCD screen.

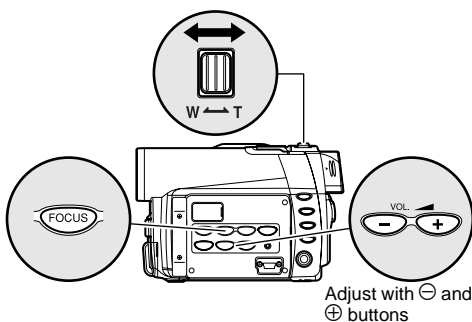

Note:

- Pressing FOCUS will alternate between manual focus and auto focus. With auto focus, no indication will appear on the screen.
- Be sure to zoom in on your subject before manually focusing on it. If you bring the subject into focus at the "W" control side, focus will be faulty when you turn the zoom lever to the "T" control side to zoom in on the subject.
- Manual focus is released when the DVD video camera/recorder is turned off. When you turn the DVD video camera/recorder on next time, auto focus will be restored.

Manually focus the following objects, which may not be automatically focused (See page 57):

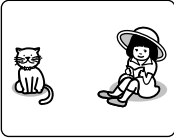

Objects not in the center of screen

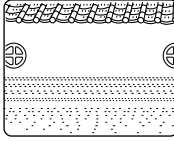

Objects with little variation in brightness, such as white wall



Objects that are far and near at the same time



Objects moving rapidly



Objects lit by neon sign, spotlight, etc. which glares or emits strong light



Dark objects

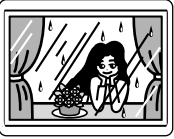

Object behind glass with water droplets, dirt on it



Night view

Adjusting Exposure Manually

This DVD video camera/recorder measures the subject brightness and automatically adjusts the exposure. You can also adjust the exposure manually.

1 Press the EXPOSURE button during recording.

The exposure indicator will appear on the screen.

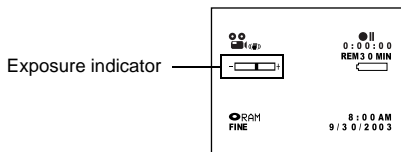

2 Use the \ominus \oplus buttons to adjust the exposure, while viewing the image in the viewfinder or on the LCD screen.

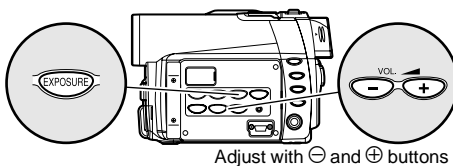

Note:

- Pressing EXPOSURE will alternate between manual adjustment and auto exposure. With auto exposure, no indication will appear on the screen.
- The exposure setting will return to Auto when the DVD video camera/recorder is turned off.

Compensating for Backlight

When subject is lighted from rear, this function will compensate for lighting so that the subject is not too dark.

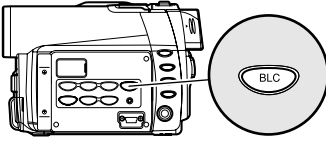

1 Press the BLC button during recording.

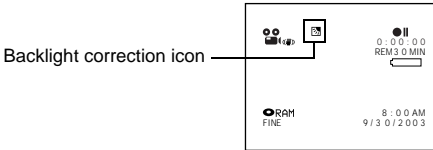

The backlight correction icon will appear.

Note:

- Pressing the BLC button will alternate between backlight setting between on and off.
- The backlight setting will automatically return to "off" when the DVD video camera/recorder is turned off.

Using Full Auto Function

Pressing the FULL AUTO button will fully automate the camera functions.

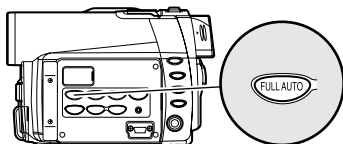

- 1 Press the FULL AUTO button.

The following settings will reset to defaults:

Function	When setting full auto
Program AE	Auto
White balance	Auto
Exposure	Auto
Backlight compensation	Off
Focus	Auto
EIS	On
MIC.Filter	Off

On-Screen Information

Various types of information will appear in the viewfinder or on the LCD screen during recording.

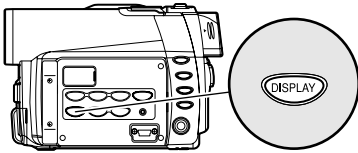

INFORMATION DISPLAY DURING RECORDING

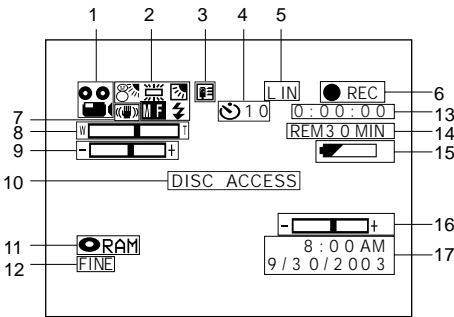

The above screen is an example for explanation: It is different from the actual display.

1. Recording mode

- : Movie
- : Still
- : External input still (field)
- : External input still (frame)

2. Program AE (only in movie recording mode)

- No display: Auto
- : Sports
 - : Portrait
 - : Spotlight
 - : Sand & Snow
 - : Low Light

White balance

- No display: Auto
- : Set
 - : Outdoor
 - : Indoor1
 - : Indoor2

Backlight compensation

- No display: Backlight compensation OFF
- : Backlight compensation ON

Manual focus

- No display: Autofocus
- : Manual focus

External flash*¹ [when Video Flash (sold separately) is attached] (only in still recording mode)

No display: Emits light automatically

: Always emits light

: No light emission

3. Microphone filter (only in movie recording mode)

No display: Microphone filter OFF

- : Microphone filter ON

4. Self-timer (only in still recording mode)

No display: Self-timer OFF

- : Self-timer ON (count is from 10 seconds)

5. External Input

- L IN : AV input
- S IN*¹ : S-VIDEO input

6. Recording status

- : During recording
 - : During recording pause
- No display*²

7. Electronic image stabilizer (EIS) (only in movie recording mode)

No display: EIS OFF

- : EIS ON

8. Zoom

W T
(Digital Zoom: Off)







W T
(Digital Zoom: 40x)

W T
(Digital Zoom: 240x, only in movie recording mode)

9. Exposure correction

10. Warning message

11. Disc/Card type

-  RAM : DVD-RAM
-  R : DVD-R
-  RAM : DVD-RAM (write-protected)
-  F : DVD-R disc already finalized on this DVD video camera/recorder
-  : DVD-R disc finalized on a device other than this DVD video camera/recorder
-  : SD memory card or multimedia card
-  : Locked SD memory card
- No display^{*3}

12. Movie recording quality (only when using disc)

- XTRA : Highest quality (only when using DVD-RAM disc)
- LPCM : Highest audio quality (only when using DVD-R disc)
- FINE : High quality
- STD : Standard

Still recording quality (only when using card)



- FINE : High quality
- NORM : Standard
- ECO : Number of recordable stills is prioritized

13. Movie recording time (only in movie recording mode)

14. Remaining space on disc/card^{*4}

- REM XX MIN^{*5} : Remaining recordable minutes during movie recording
- REM XX^{*6} : Number of remaining recordable still images during still recording

15. Remaining battery level

-  (full charge)
-  ↓
-  (low remaining charge)

16. Brightness/Color density of LCD screen or

Volume



The volume can be adjusted during external input and playback.

17. Current date/time

*1 Not displayed on DZ-MV350A.

*2 When no disc or card is in the DVD video camera/recorder, or disc has not yet been initialized, a write-protected disc or locked card, or a disc or card with no remaining space, has been inserted.

*3 When a disc or card that cannot be used in this DVD video camera/recorder is inserted

*4 No remaining time or number will be displayed with a protected disc or locked card, or finalized DVD-R disc.

*5 In XTRA mode, possible recording time may be longer than the displayed time.

*6 The displayed number of recordable stills is for reference: The decreasing number may not be correct, depending on recording conditions (not displayed with a DVD-R disc).

● Switching the information display mode

You can switch the display mode of on-screen information:

Press the DISPLAY button.

The full and minimum display modes will alternate.

- **Full display mode:** All types of information will appear.
- **Minimum display mode:** The recording mode (see 1 on page 62) and recording status (see 6 on page 62) will appear. If the DVD video camera/recorder has warning information, a warning message will appear.

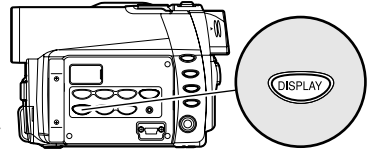

Note:

The DVD video camera/recorder does not record the date and time as a part of image. However, this information during recording will be recorded with image as data which can be checked on Disc Navigation screen during playback (See "Information Display During Playback" on page 71).

● Display when recording an image of yourself

When recording with the LCD screen facing the same direction as the lens, the operating status will appear, and in addition, the battery remaining level will blink when the battery has almost no remaining charge.

The following operating status indicator will light or blink to give warning message to user. The message can be checked when returning the LCD monitor 180° to the original status from the status in which the LCD screen was facing the same direction as the lens.

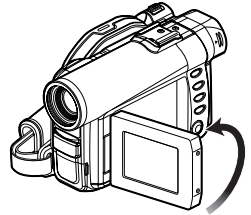

- : The disc has almost no free space.
- : Write-protected disc or locked card is loaded.
- : You are attempting to record a still on DVD-R disc.
- No display : Disc or card that cannot be used has been loaded.
- ||● : The disc or card is full, or you are attempting to record a copy-guarded image.

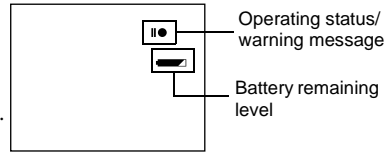

Note:

- If the LCD screen is set facing the same direction as the lens, the LCD screen will display a mirror image (left and right reversed).
- If the LCD screen is set facing the same direction as the lens, you can also view subject image in the viewfinder.
- Although you can switch to the manual focus, exposure and on-screen display modes even during recording with LCD screen facing the same direction as lens, they will not appear on the screen.

Recording Image from Other AV Devices

You can record images from other AV devices to disc or card in this DVD video camera/recorder.

CONNECTING TO OTHER AV DEVICE

Use the AV/S input/output cable (provided) to connect the DVD video camera/recorder to the other AV device as follows:

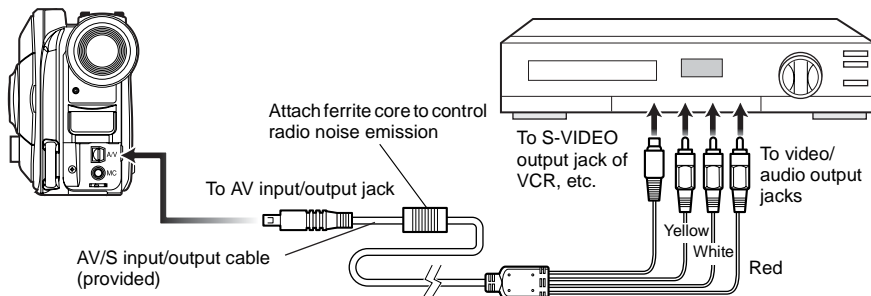

* If you are using DZ-MV380A and the connected AV device has an S-VIDEO output jack, you can connect the S-VIDEO jack of AV/S input/output cable.

Note:

- If you operate the DVD video camera/recorder connected to another device, always power the camera/recorder from AC outlet using the AC adapter/charger.
- If you use a Hitachi VCR, it will be operated by the remote control provided with the DVD video camera/recorder. When recording an image from a Hitachi VCR, change the remote control code of the VCR to other than "VCR2".
- With DZ-MV380A, using S-VIDEO will enable you to record clearer images.
- The DZ-MV350A cannot record S-VIDEO input.
- Reduce the volume of external input sound heard from the built-in speaker: The loud volume may cause noise to enter the recorded image.

RECORDING IMAGE FROM AV DEVICE

- 1 Set the input source on the DVD video camera/recorder to "LINE (LIN)".

Switch the input referring to "Input Source" on page 88.

Choose "S LINE" to input S-VIDEO signal.
(Only for DZ-MV380A)

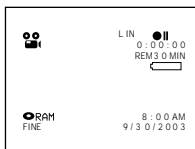

- 2 Turn on the connected device, and start playback.

The picture will appear on the LCD screen or viewfinder of this DVD video camera/recorder.

- 3 Press the REC button.

Recording will start on this DVD video camera/recorder.

The operation of this line-input recording is the same as for recording movie.

Note:

- The recorded contents can be played back in the same manner as when playing back camera images recorded on this DVD video camera/recorder.
- Still images can also be recorded on DVD-RAM disc or card. See "Switching External Input Recording Method (PHOTO Input)" on page 88 for details, and "Recording Stills" on page 53 for how to record still images.
- The "Input Source" setting will return to "CAMERA" whenever DVD video camera/recorder is turned off.
- Recording of most images is prohibited by the copy-guard signal to protect the copyright, except for images recorded on camcorders for personal enjoyment. "COPY PROTECTED" appears in these images: They cannot be recorded on this DVD video camera/recorder. Typical copyright protected images include those of DVD video, LD, recorded video tapes, some parts of digital satellite broadcasts, etc.
- If a video signal that cannot be read by this DVD video camera/recorder is present - even in images recorded on camcorder for personal enjoyment without copy-guard signal - the input image may not be recorded normally.
- If the input signal is interrupted by switching the channel on TV or switching the signal using video selector, normal recording cannot be performed.

IMMEDIATELY CHECKING RECORDED SCENE

You can check your recording immediately on the spot.

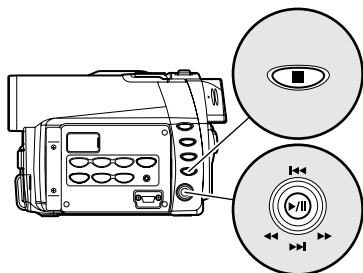

Tilt up/down and to left/right to select, and then press ►/|| to designate.

1 Press ►/|| button in the recording pause status.

The DVD video camera/recorder will enter the playback mode, and the scene you have recorded last will be played back.

When playback is finished, the DVD video camera/recorder will enter the pause status at the last image on disc.

If the playback pause status continues for as long as 5 minutes, the DVD video camera/recorder will automatically return to the recording pause status.

2 Press the □ button.

Playback will stop, and recording pause status will be restored.

Note:

- If the LCD monitor is open during playback of movie, playback sound will be heard from the speaker. Adjust the sound volume using the volume control buttons (⊖, ⊕).
- To temporarily stop playback, press the ►/|| button. Press the ►/|| button again to restart playback.
- Even if you stop playback midway and immediately start recording again, the new image will be recorded after the last scene on disc or card (the previous images will not be overwritten).
- Depending on the amount of data to be played back, it may take some time for the playback image to appear.
- Do not operate the power switch or remove the card while the ACCESS/PC or CARD ACCESS indicator is lit or blinking: Doing so may damage the card or the data on card.

Notes when playing back stills on card:

- This DVD video camera/recorder can play back image data recorded on SD memory card in other digital cameras conforming to the DCF (Design rule for Camera File system) standard. The range of image data normally playable on this DVD video camera/recorder is that with pixels from 80 horizontal x 60 vertical to 4000 horizontal x 3000 vertical. If the pixel data is outside this range, blue thumbnails will appear (thumbnails* in the figure), meaning the image is unplayable.

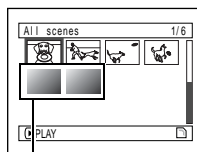

Fig. 1

- Even when the number of pixels is within the above range, playback may not be possible, depending on the recording status of the digital cameras used.
- When playing back a still, "Playback." will appear: Stills with a large number of pixels will take some time to appear.

PLAYBACK FROM START OF DISC OR CARD

Use the Go To function (P. 70) or Disc Navigation function (P. 95) to play back from the start of disc or card.

RAM R

SEARCH PLAYBACK OF MOVIE

During playback, tilt the joystick to right or left and hold it: Search playback will start.

- ⌚ Tilt and hold: Scenes will be visually scanned forward
- ⌚ Tilt and hold: Scenes will be visually scanned backward

Release the joystick when you find the desired image: Normal playback will start from that point.

RAM R

FRAME ADVANCE/FRAME BACK/SLOW PLAYBACK OF MOVIE

During playback pause, tilt the joystick: Frame advance, frame back or slow playback will start.

- ⌚ Tilt once : Picture will advance one frame.
- ⌚ Tilt once : Picture will go back one frame.
- ⌚ Tilt and hold : Forward slow playback
- ⌚ Tilt and hold : Reverse slow playback

After frame advance, frame back or slow playback, the DVD video camera/recorder will enter the playback pause status.

Note:

- When you skip or search scenes from playback or playback pause, the screen will be dark briefly.
- See page 147 if search playback does not operate normally.

Note:

- In forward slow, a rapidly moving subject image may be distorted.
- The intervals for playing back frames in frame advance/frame back/slow playback are as follows:
Frame advance and forward slow: Approx. 0.03 second
Frame back and reverse slow: Approx. 0.5 second
- No sound will be heard during search playback or slow playback.

SKIP PLAYBACK OF MOVIE

During playback, tilt the joystick up or down to locate the start of desired scene.

- ⌚ Tilt once : To skip to the first image of the scene following the one being played back, and start playback.
- ⌚ Tilt once : To return to the first image of the scene being played back, and start playback.
- ⌚ Tilt and hold : To continuously locate the beginnings of scenes, starting from the scene following the scene being played back. When the desired image appears, release the joystick: Playback will start from that point.
- ⌚ Tilt and hold : To continuously locate the beginnings of scenes backward, starting from the scene preceding the scene currently being played back. When the desired image appears, release the joystick: Playback will start from that point.

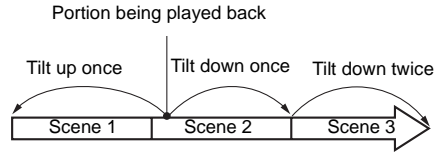
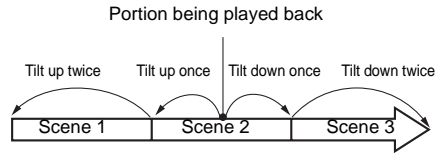

Tilting up the joystick at a portion several seconds from the start of scene being played back will return to the start of the scene preceding that being played back.

Note:

- If you perform skip playback during playback pause, the DVD video camera/recorder will enter the playback pause status at the beginning of the located scene.
- Tilting down in the last scene on disc will set the DVD video camera/recorder to the playback pause status at the last image.
- See page 147 if skip playback does not operate normally.

PLAYING BACK STILLS

Tilt the joystick up or down during playback to quickly play back stills in sequence.

- ⌚ Tilt once: To display stills one by one forward
- ⌚ Tilt once: To display stills one by one backward

[When using disc]

Releasing the joystick will start continuous playback.

[When using card]

When the joystick is released, the photo at that point will be displayed, and then the DVD video camera/recorder will enter the playback pause status.

Set the slide show function for continuous display (P. 131).

JUMPING TO SPECIFIED POINT (GO TO)

- 1 Press the MENU button during playback.
- 2 Choose the option (point you want to go to), and then press the ►/|| button.

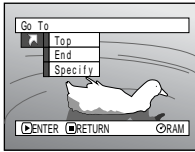

- Top : To go to the start, and enter playback pause.
- End : To go to the end of last scene, and enter playback pause.
- Specify : To go to a specified point and enter playback pause. See the following for details.

● Specifying the point to view

- 1 Choose “Specify” in step 2 above, and then press the ►/|| button.

The screen for specifying the point to go to will appear.

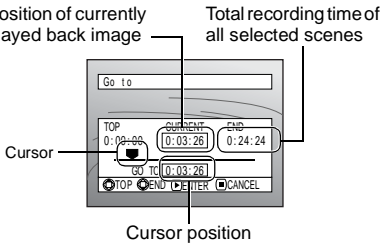

- 3 Press the ►/|| button to enter the selection.

The DVD video camera/recorder will go to the specified point and enter the playback pause status.

To cancel the “Go To” procedure midway, press the □ button before going to the specified point.

Note:

- If multiple scenes are selected using the Disc Navigation function or SELECT button, choosing “Top” will jump to the beginning of selected scenes (P. 125).
- When multiple scenes are selected, the total time of selected scenes will appear in the “total recording time” display.
- When card is loaded, the number of stills will appear.
- The cursor may not move at same-pitch intervals.

- 2 Use the joystick to select the desired time of chosen point.

- ◁ : To select the start.
- ▷ : To select the end.
- ◁ ▷ : Press once: To move the cursor in 10-second units (1-still units for card)
- Hold down: To move the cursor in 1-minute units (10-still units for card)

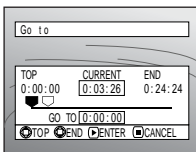

(When the start of scene is selected)

- ☐ Cursor at current image position.
- ♥ Cursor at (GO TO) position.

On-Screen Information Display

INFORMATION DISPLAY DURING PLAYBACK

Various types of information on recording will be superimposed on playback image you are viewing.

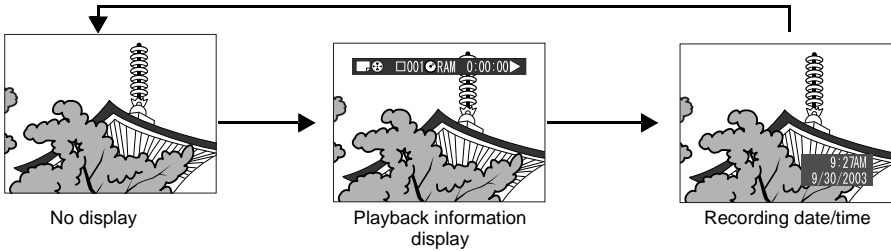

● Switching the information display mode

Press the DISPLAY button: You can switch the display mode of on-screen information.

When using disc:

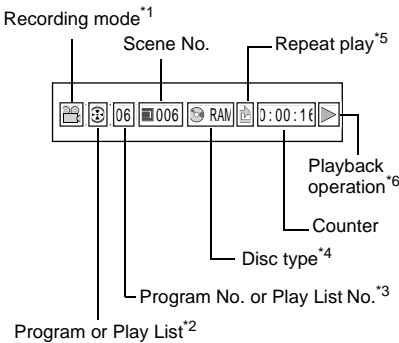

When using card:

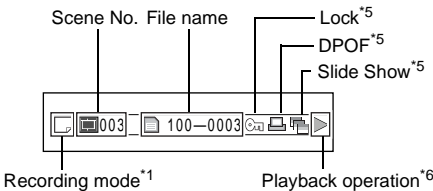

*1 (VIDEO) or (PHOTO); Only (PHOTO) with card.

*2 Program or Play List

*3 Number of program or play list being played back (not displayed when all programs are being played back)

*4 Refer to "Disc/Card type" on page 63.

*5 : Will appear when each function is specified "On"

*6 : Standard playback

: Playback pause

: Forward search playback

: Reverse search playback

: Forward skip playback

: Reverse skip playback

: Forward frame advance

: Reverse frame back

Refer to "Playing Back" beginning on page 67 for how to operate.

The "" mark will appear on the first image on disc.

The "" mark will appear on the last image on disc.

- **Recording date/time display:** Shows the date/time when recording was started. Even when playback starts, the date/time display will not advance.
- **No display:** No information will appear.

However, when the mode of playback operation is switched, the symbol will appear for approx. 3 seconds.

Note:

See "Using Disc Navigation" on page 95 and later for explanation on program and play list.

Playback on Other Devices

This section explains about playback on another AV device, such as TV.

RAM R CARD

CONNECTING TO A TV

Use the provided AV/S input/output cable to connect the DVD video camera/recorder to a TV as follows:

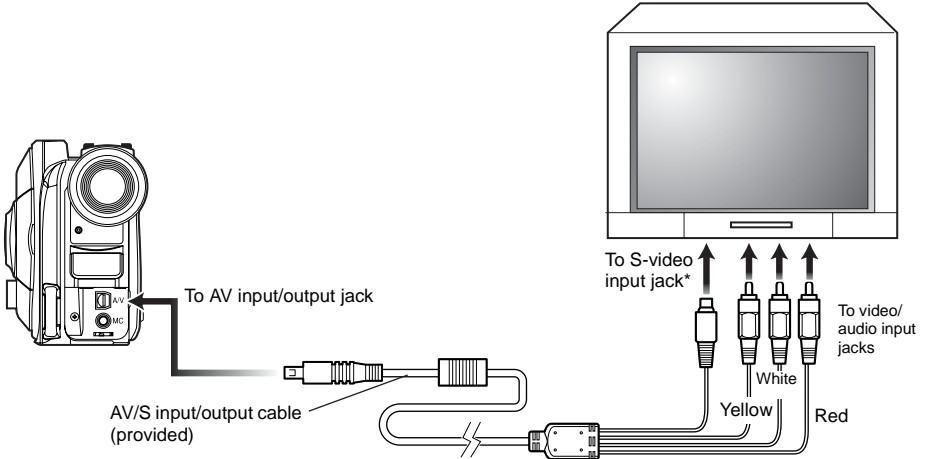

* If your TV has an S-VIDEO input jack, you can connect the S-VIDEO plug to it.

Note:

- Using S-VIDEO will deliver clearer playback status.
- Before connecting, make sure that the volume on TV is turned down: Forgetting this may cause howling from the TV speakers.
- Insert the AV/S input/output cable plugs into jacks straight: Obliquely inserting them could damage the jacks.

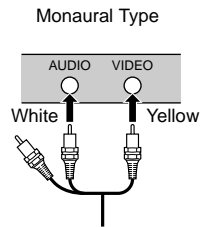
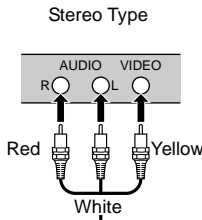
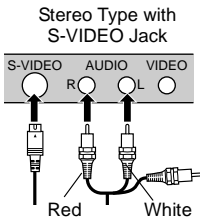

VIEWING ON TV SCREEN

- 1 Turn the TV on and set the input selector to "VCR" whichever applicable Video input.

Refer to the TV instruction manual for how to switch the TV input.

- 2 Turn the DVD video camera/recorder on.

The image that the DVD video camera/recorder is seeing will appear on the TV screen.

You can also monitor the image on the LCD screen or viewfinder of the DVD video camera/recorder.

- 3 Perform playback, recording or editing.

You can perform playback, editing or editing on Disc Navigation while checking on TV screen.

Note:

- Adjust the volume of sound on TV.
- The infrared remote control is useful when operating the DVD video camera/recorder while viewing an image on TV screen. However, if you use a Hitachi VCR, the remote control may inadvertently operate the VCR if it is near the DVD video camera/recorder. To prevent this, set the remote control code of the VCR to a position other than "VCR2".
- Information that the DVD video camera/recorder is recording will appear on the TV screen: You can also display only part of information or switch off the display. Refer to "Setting On-Screen Display Output On or Off (OSD Output)" on page 90, and press the DISPLAY button to switch the display status.
- When copy-guarded disc is played back, no image will appear on TV screen.
- If you use TV with wide mode (aspect ratio 16:9) and set the TV to the wide mode, the entire Disc Navigation display may not be displayed on the TV screen. If this happens, release the wide mode setting on TV (see the TV instruction manual for releasing the wide mode).

PLAYBACK ON DVD PLAYER

You can play back finalized DVD-R discs on DVD players or other devices that conform to 8 cm DVD-R disc. However, DVD-R discs may not be usable on all those devices.

1 Finalize a recorded DVD-R disc.

You need to finalize a disc to play it back on DVD player: See page 129.

No further data can be recorded on finalized disc.

Note:

Use this DVD video camera/recorder to finalize the DVD-R disc recorded on the DVD video camera/recorder.

2 Remove the disc from Round DVD Holder.

See "Removing and Replacing from/in Round DVD Holder" on page 75.

3 Insert the disc into the DVD player and play it back.

See the instruction manual for DVD player.

Note:

DVD-R discs recorded on this DVD video camera/recorder can be played back on other DVD players, but playback on all DVD players is not guaranteed.

Playback may not be possible on some DVD players, or it may depend on the recorded status of DVD-R discs: In such cases, play back the DVD-R disc on this DVD video camera/recorder.

REMOVING AND REPLACING FROM/IN ROUND DVD HOLDER

You can remove DVD-RAM or DVD-R disc used on this DVD video camera/recorder from Round DVD Holder and use the uncovered disc on DVD player, DVD-RAM recorder, drive for PC, etc., which conforms to 8 cm DVD-RAM or 8 cm DVD-R. Removing disc from Round DVD Holder may vary with the disc maker: See the disc instruction sheet. The following explains the disc in Round DVD Holder made by Hitachi Maxell.

It is recommended that you do not remove the disc from Round DVD Holder until camera recording is finished, in order to avoid getting dirt on disc.

Note:

Using discs removed from holders on various devices may not always be possible.

HOW TO REMOVE DISC

1 Hold the Round DVD Holder with SIDE A facing up. While pushing the two release levers in the direction of arrows (1) marked on holder, slowly open SIDE A of the holder in the direction of arrows (2), taking care not to drop the disc.

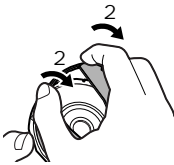
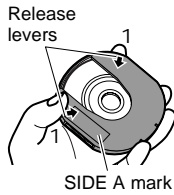

Do not open more than 90°.

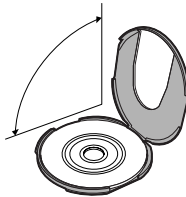

2 Without touching the recording/playback surface, hold the disc edge and center hole to remove it.



REPLACING DISC IN ROUND DVD HOLDER

- 1 Open SIDE A of the Round DVD Holder, and replace the disc in the holder with the SIDE A mark or label surface facing up, taking care not to touch the disc surface.
- 2 Close SIDE A of the Round DVD Holder, and push it to lock the release levers at positions (3).

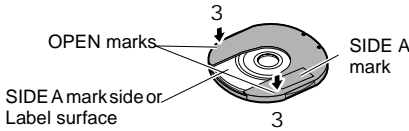

WHEN THE HINGE OF ROUND DVD HOLDER COMES OFF

- 1 Push the hinged portion of the holder piece marked SIDE A with thumb and middle finger, and warp it in the direction of arrows (4).
- 2 Fit the hinged portion of the other holder piece into the warped hinge portion.

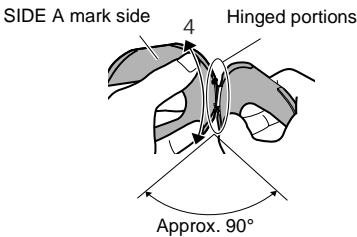

Note:

- Handle the disc carefully so that no scratch, dirt, fingerprint or dust adheres to the recording/playback surface.
- When not using the Round DVD Holder, store it in case. Do not leave a bare holder as is.
- Be careful of drop or impact: If you drop the Round DVD Holder, the disc may pop out.
- Do not subject the Round DVD Holder to force.

DISC CLEANING

Use a soft, dry cloth to lightly wipe off any dust, dirt, etc. adhering to disc, as shown in the figure. Never use solvent. Do not use thinner, water, anti-static spray, etc. to clean disc.



Use soft cloth to clean from inner to outer circumference in axial direction.

Playback on DVD Video Recorder/Player

You can use a DVD video recorder or DVD player that conforms to DVD-RAM to play back DVD-RAM discs recorded on this DVD video camera/recorder

- 1** Remove the disc from Round DVD Holder.
- 2** Insert the disc into the DVD video recorder/player and play it back.

See the instruction manual for DVD video recorder/player.

Note:

- Do not insert a DVD-R disc that has not been finalized into a DVD video recorder: The recorded image data may be damaged.
- When playing back disc on another device, the Disc Navigation display will be different from the one on this DVD video camera/recorder.

Advanced Techniques

This section explains about various settings to further extend the usefulness of this DVD video camera/recorder.

Understanding Flow of Menu

Press the MENU button during recording pause: The “Camera Functions Setup” menu screen will appear.

Tilt the joystick up, down, to left or right to select a menu item, and then press the ►/II button to choose the option.

The screens used here to explain are displayed when DVD-RAM disc is used. Some items will not appear when a DVD-R disc or card is used, or when no disc or card is inserted.

<Interpreting screen for setting>

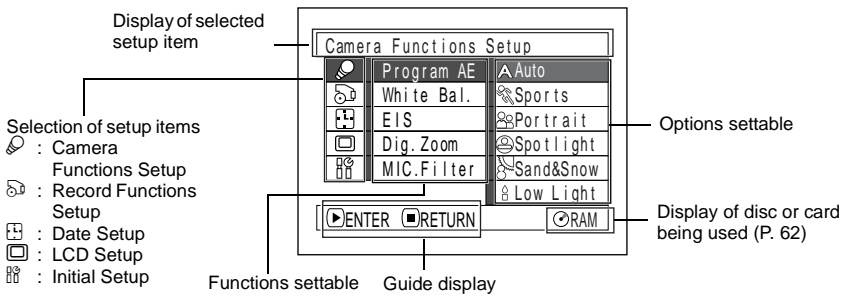

● Flow of Menu

Refer to page indicated for details of each function.

Camera Functions Setup

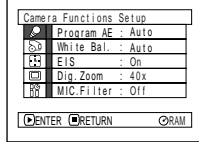

Program AE (P. 80)
White balance (P. 81)
EIS (P. 83)
Digital zoom (P. 84)
Microphone filter * (P. 85)
*Not displayed when using card.

Date Setup

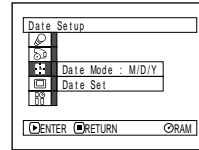

Display format (P. 49)
Date setting (P. 48)

Recording Functions Setup

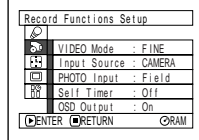

Movie quality (P. 86)
[The quality mode will appear when using card (P. 87)]
Input selection (P. 88)
External still input (P. 88)
Self-timer (P. 89)
On-screen information display output (P. 90)

LCD Setup

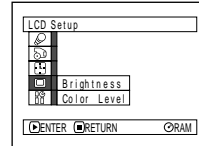

Brightness (P. 91)
Color density (P. 91)

Initial Setup

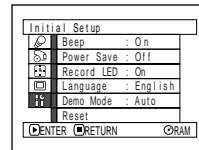

Beep (P. 92)
Power save (P. 92)
Recording LED (P. 93)
Language selection (P. 93)
Demo mode (P. 146)
Reset (P. 94)

You can use the joystick on DVD video camera/recorder to select various setting options in menu and designate them.

Press the MENU button.

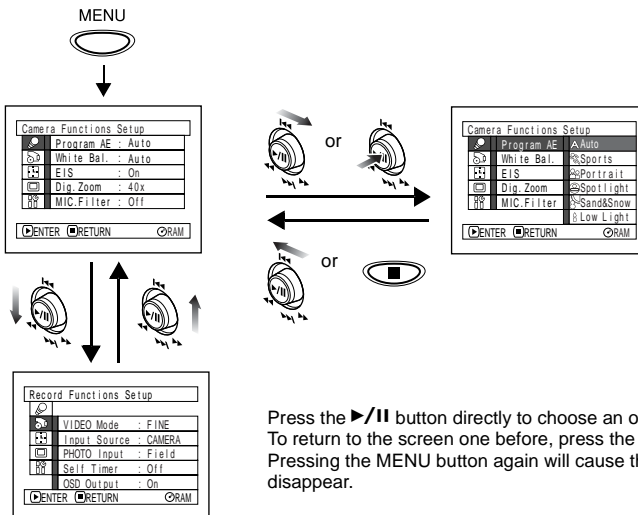

Press the ►/|| button directly to choose an option from menu. To return to the screen one before, press the ◀ button. Pressing the MENU button again will cause the menu screen to disappear.

Note:

- Pressing the MENU button during recording will not work.
- The menu screen will disappear when it is left for approx. one minute without any operation.
- With DZ-MV380A, the range of screen in which recording stills is possible will be different for disc and card.

Setting Up Camera Functions

SELECTING SHOOTING MODE TO MATCH THE SUBJECT (SWITCHING PROGRAM AE MODE)

This DVD video camera/recorder automatically sets the shutter speed and aperture according to the subject brightness for optimum recording. You can also specify one of six modes depending on the subject conditions, recording environment or purpose of filming.

- 1 Press the MENU button, use the joystick to choose "Program AE" on the "Camera Functions Setup" screen, and then press the ►/|| button.

The options will appear on the right of "Program AE".

- 2 Use the joystick to choose the desired option, and then press the ►/|| button: The selected option will be set.

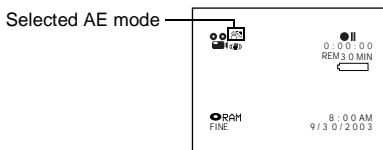
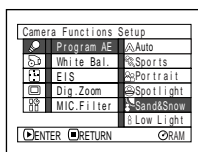

- 3 Press the MENU button to end the setting.

The menu screen will disappear.

Note:

- You can check the selected AE mode by the on-screen information display. However, nothing will appear in the Auto mode.
- The shooting mode set as above will be stored in memory even if the DVD video camera/recorder is turned off.

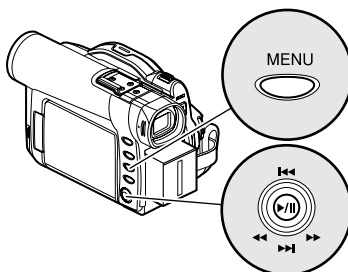





Tilt up/down and to left/right to select, and then press ►/|| to designate.

- Auto** : The camera/recorder automatically judges the subject and surrounding environment for optimum recording.
- Sports** : Reduces blurring when recording rapidly moving subjects such as in golf or tennis. If the Sports mode is used under a fluorescent light, the image may flicker: In this case, use the Auto mode for recording.
- Portrait** : Makes a subject, such as a person or a creature, stand out from a blurred background.
- Spotlight** : Prevents overexposure of subject portrait face, etc. when strong light strikes the subject, as in a wedding or on stage.
- Sand & Snow** : Prevents underexposure of subject portrait face, etc. in a place where reflection of light is intense, such as at the seaside in midsummer or on a ski slope.
- Low Light** : Allows user to record in a dark place even with decreased lighting: However, an after-image will appear with a moving subject. Note that the Low Light mode cannot be used when the recording quality mode is STD. If there is difficulty in automatically focusing subject image, adjust the focus manually.

ADJUSTING COLOR (WHITE BALANCE)

This DVD video camera/recorder automatically adjusts the tint to match the conditions of subject. However, it may not allow user to deliver natural tint, depending on the weather or status of light source. In this case, change the white balance setting according to the situation.

Mode	Setting content	On-screen display
Auto	White balance always automatically adjusted	None
Set	You can manually adjust white balance to match the light source or situation	
Outdoor	To record in fine weather	
Indoor 1	To record under incandescent light, halogen light or bulb-color type fluorescent light	
Indoor 2	To record under fluorescent light	

1 Press the MENU button, choose "White Bal." on the "Camera Functions Setup" menu screen, and then press the ►/II button.

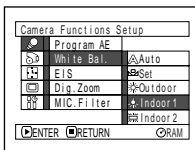

2 Choose the desired option, and then press the ►/II button.

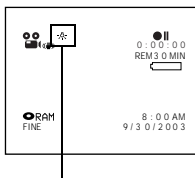

White balance mode

3 Press the MENU button to end the setting.

Note:

- The white balance mode can be confirmed using the on-screen information.
- The white balance setting will be stored in memory even when the DVD video camera/recorder is turned off.
- Do not block the infrared sensor with hand, etc.

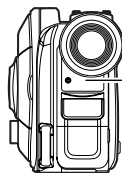

Infrared sensor block

- If a tele or wide-conversion lens is used, the auto white balance may not operate depending on the recording conditions. If this happens, set to the mode to match the recording conditions, or manually set the white balance.
- Be sure to remove the lens cap before turning the DVD video camera/recorder on: If the DVD video camera/recorder is turned on with the lens capped, the white balance will not work normally.

● Setting white balance manually

- 1 Point the DVD video camera/recorder at a white object so that it fills the screen. Use an object that is not transparent.

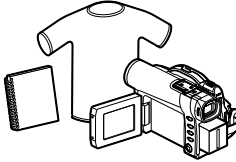

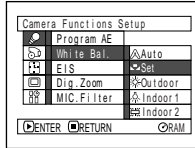

White shirt or thick paper

- 2 Press the MENU button, choose “White Bal.,” “Set”, and then press the **▶/||** button.

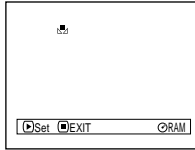

- 3 Press the **▶/||** button: The “” indicator will change from blinking to a steady light: The steady light indicates that the white balance setting is complete.



- 4 Press the  button to end the setting.

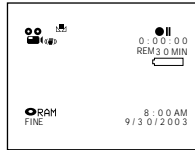

Note:

- The white balance set using the “Set” option will be stored in memory until it is reset.
- Do not use a colored object when setting the white balance: The appropriate tint cannot be set.
- If “Input Source: LINE” has been specified, you cannot use the “Set” mode of white balance (P. 88).

USING THE ELECTRONIC IMAGE STABILIZER (EIS)

This DVD video camera/recorder is equipped with an electronic image stabilizer function: When you use zoom to record a magnified subject image, it will correct fuzziness in the recorded image.

- 1 Press the MENU button, choose “EIS” on the “Camera Functions Setup” menu screen, and then press the ►/|| button.

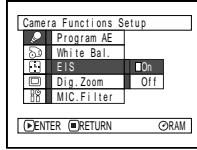

- 2 Choose the “On” or “Off”, and then press the ►/|| button.
- 3 Press the MENU button to end the setting.

● Checking EIS On or Off

You can check EIS On or Off by the on-screen information display.

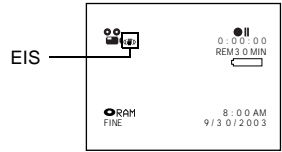

After recording with EIS set to “Off”, it is recommended that you return the setting to “On” and then turn the DVD video camera/recorder off, unless you normally record with “Off” setting. This function is effective only during movie recording: It will not work during still recording.

Note:

- The EIS setting will be stored in memory even when the DVD video camera/recorder is turned off.
- Although you can switch EIS between on and off during still recording, the setting will be effective only during movie recording.
- It is recommended that you specify “EIS Off” when using the DVD video camera/recorder on a desk or tripod.
- When “EIS On” is specified, there will be a slight difference between the actual movement and the movement on screen.
- Gross camera shake may not be entirely corrected even if “EIS On” is specified.
- EIS may not operate correctly when the tele or wide-conversion lens (generally available) is used.

MAGNIFYING SUBJECT IMAGE (DIG. ZOOM)

When the zoom lever is moved down to “T” control side with Dig. Zoom 40× or 240× specified, digital zoom will automatically kick in when optical 10× zoom range is exceeded. You can set the digital zoom to 40× or 240× for movie recording, or 40× for still recording.

- 1 Press the MENU button, choose “Dig. Zoom” on the “Camera Functions Setup” menu screen, and then press the ►/II button.

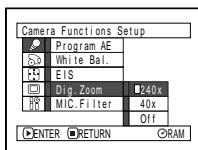

- 2 Choose the desired magnification, and then press the ►/II button.

- 3 Press the MENU button to end the setting.

Moving the zoom lever will display the digital zoom bar.

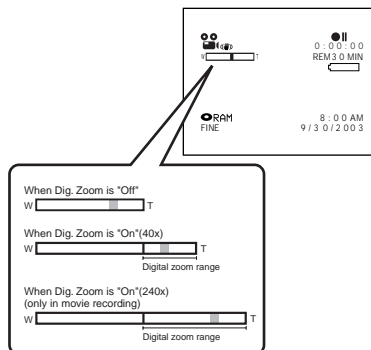

Dig. Zoom “240×”, “40×” or “Off” setting will be stored in memory even if the DVD video camera/recorder is turned off.

Note:

- You can check whether Dig. Zoom is “240×”, “40×” or “Off” by pressing the DISPLAY button and reviewing the on-screen information.
- You can also use the DIGITAL ZOOM button on remote control to switch the digital zoom setting: Pressing the button during movie recording will switch the setting between “Off”, “40×” and “240×”: Pressing the button during still recording will switch between “Off” and “40×”.
- When using card, zooming only up to 40× is possible, even when “240×” or “40×” has been chosen.
- If the power switch is set to [] PHOTO with DVD-RAM disc loaded, zooming only up to 40× is possible, even when “240×” has been chosen.

REDUCING WIND NOISE DURING RECORDING (MIC.FILTER)

When recording sound from the microphone built into this DVD video camera/recorder, you can reduce wind noise in recording.

If “MIC.Filter: ON” is specified, the low-frequency components in the sound picked up by microphone will be cut off during recording: This makes it easier to hear the target voice or sound during playback.

- 1 Press the MENU button, choose “MIC.Filter” on the “Camera Functions Setup” menu screen, and then press the ►/II button.

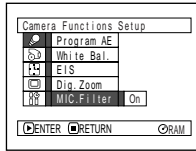

- 2 Choose the desired option, and then press the ►/II button.

- 3 Press the MENU button to end the setting.

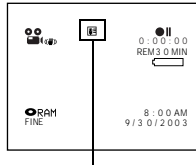

Microphone filter icon

Note:

- You can also use the on-screen display to confirm that the MIC.Filter has been set.
- The MIC.Filter setting will be stored in memory even when the DVD video camera/recorder is turned off.
- The MIC.Filter function will work only during movie recording.
- The microphone filter function works only with the built-in microphone: It will not function when using an external microphone (P. 52).

Setting Up Record Functions

RAM R

SWITCHING MOVIE QUALITY (VIDEO MODE)

Choose the movie quality from “XTRA” (only with DVD-RAM disc), “FINE”, “STD” and “LPCM” (only with DVD-R disc).

It is recommended that you record critical subjects in the “XTRA” or “FINE” when you are using a DVD-RAM disc, or in the “FINE” with a DVD-R disc.

1 Press the MENU button, choose “VIDEO Mode” on the “Record Functions Setup” menu screen, and then press the ►/|| button.

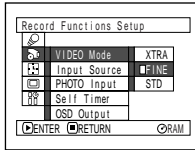

2 Choose the desired quality mode, and then press the ►/|| button.

3 Press the MENU button to end the setting.

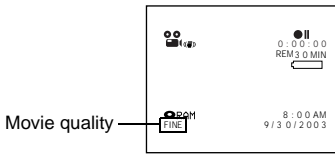

Note:

- The movie quality setting will be stored in memory even when the DVD video camera/recorder is turned off.
- The “VIDEO Mode” setting will not change even if the DVD-RAM disc is replaced with a DVD-R disc, or vice versa. However, if “XTRA” has been set with DVD-RAM disc, or “LPCM” has been set with DVD-R disc, “FINE” will be set when the disc is changed.
- When using DVD-R disc, you cannot switch the movie quality while recording on the disc: The DVD video camera/recorder will be automatically set to the movie quality first used with the disc for recording.
- The movie quality setting is effective only during movie recording: Switching the movie quality will not work during still recording.

Block-like noise may appear in recorded image, or the outline of subject image is distorted under the recording conditions listed below: Pan the DVD video camera/recorder as slowly as possible. (Block noise is likely to appear in the “STD”):

- If there is a complicated pattern in background (as in following figure on left)
- If the DVD video camera/recorder is moved excessively or quickly
- If subject is moving rapidly even when the DVD video camera/recorder is not moving

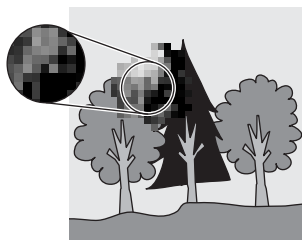

(Image when block-like noise occurs)



(Image without block-like noise)

CARD

SWITCHING QUALITY OF STILL IMAGE (QUALITY)

You can switch the still recording quality only when using card.

It is recommended that you use “FINE” when recording vital images.

- 1 Press the MENU button, choose “Quality” on the “Record Functions Setup” menu screen, and then press the ►/|| button.

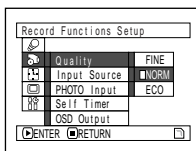

- 3 Press the MENU button to end the setting.

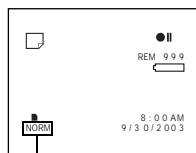

Still recording quality

- 2 Choose the option you want, and then press the ►/|| button.

Note:

The still quality setting will be stored in memory even when the DVD video camera/recorder is turned off.

RECEIVING IMAGE FROM ANOTHER DEVICE (INPUT SOURCE)

If you wish to input an image from another device to this DVD video camera/recorder, you must first switch the setting on the DVD video camera/recorder. Refer to the explanation starting from page 65 on how to connect the DVD video camera/recorder to other devices or record images input from them.

Setting	Content	On-screen display
CAMERA	Usually select this option.	No display
LINE	To input image from another device	L IN
S LINE*	To input S-VIDEO signal from another device	S IN

* Displayed on DZ-MV380A only.

1 Press the MENU button, choose "Input Source" on the "Record Functions Setup" menu screen, and then press the ►/|| button.

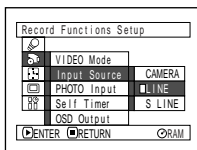

2 Choose "LINE", and then press the ►/|| button.

3 Press the MENU button to end the setting.

Note:
The "Input Source" setting will return to "CAMERA" whenever the DVD video camera/recorder is turned off.

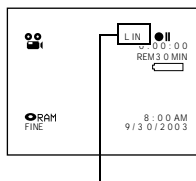

External input icon

SWITCHING EXTERNAL INPUT RECORDING METHOD (PHOTO INPUT)

You can record stills of externally input images on a DVD-RAM disc or card in the Frame or Field mode. The DVD video camera/recorder can record an external image with little movement by specifying "Frame", but "Field" is recommended for recording image with movement.

Recording format	Details of setting	On-screen display
Frame	Does not suit recording of frequently moving video subjects, despite high image quality. Frame suits recording of less moving video.	
Field	Suitable for recording of frequently moving video subjects.	

1 Press the MENU button, choose "PHOTO Input" on the "Record Functions Setup" menu screen, and then press the ►/|| button.

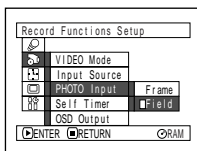

2 Select the desired option and then press the ►/|| button.

3 Press the MENU button to end the setting.

Still external input mode

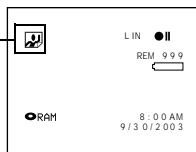

Note:

- The PHOTO Input setting can be confirmed using the on-screen information.
- The PHOTO Input setting will be stored in memory even when the DVD video camera/recorder is turned off.
- Refer to "Recording Image from Other AV Devices" on page 65 to see how to connect the DVD video camera/recorder to another device.

SELF-TIMER

You can record stills of yourself alone or with your family, friends, etc., using the self-timer function, as with ordinary cameras. A still will be recorded approximately 10 seconds after the REC button is pressed.

- 1 Press the MENU button, choose “Self Timer” on the “Record Functions Setup” menu screen, and then press the ►/|| button.

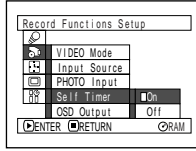

- 2 Select “On”, and then press the ►/|| button.

The self-timer will be set.

- 3 Press the MENU button to end the setting.

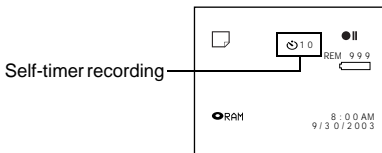

- 4 Press the REC button.

The recording indicator at the front of DVD video camera/recorder will blink.

The self-timer indicator will start to count down, and recording will commence approximately 10 seconds later.

Note:

- You can also check that self-timer has been set by reviewing the on-screen information.
- To release the self-timer mode, choose “Off” on the menu screen or turn DVD video camera/recorder off.
- To suspend self-timer, press the REC button again before recording starts, or press the □ button.
- When the REC button is pressed, the ●|| mark on LCD screen will be pink. It will also change in the same way when recording with the LCD screen facing the same direction as the lens.

SETTING ON-SCREEN DISPLAY OUTPUT ON OR OFF (OSD OUTPUT)

If you connect this DVD video camera/recorder to a TV to view images on TV screen, you can switch off the on-screen information (displayed in the viewfinder or on the LCD screen) from the TV screen.

1 Press the MENU button, choose "OSD output" on the "Record Functions Setup" menu screen, and then press the ►/|| button.

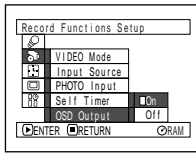

2 Choose "On" or "Off", and press the ►/|| button.

3 Press the MENU button to end the setting.

Note:

- The "OSD Output" setting will be stored in memory even when the DVD video camera/recorder is turned off.
- Even if "Off" is chosen, the on-screen information will appear during playback. See page 71 for playback on-screen information display.
- Even after the on-screen information is removed from the TV screen, it will still appear in the viewfinder or on the LCD screen.

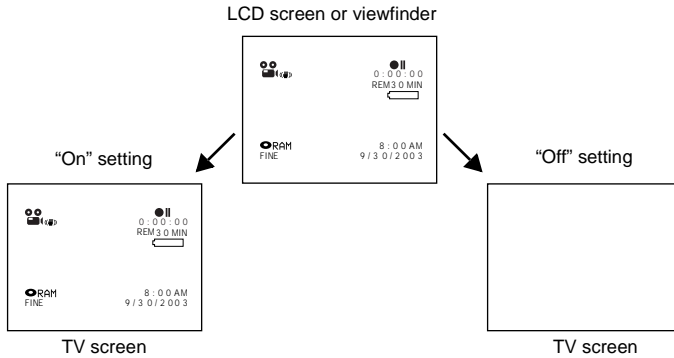

LCD Setup

This function allows you to adjust the brightness and color density of LCD screen during recording and playback.

SETTING BRIGHTNESS OF LCD SCREEN (BRIGHTNESS)

- 1 Press the MENU button, choose "Brightness" on the "LCD Setup" menu screen, and then press the ►/|| button.

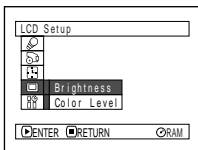

The brightness adjustment bar will appear on the screen.

- 3 Press the MENU button to end the setting.

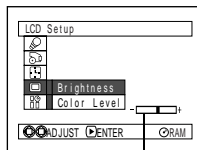

Brightness adjustment bar

- 2 Use the joystick for adjustment.

- ⊖: The screen becomes dimmer
- ⊕: The screen becomes brighter

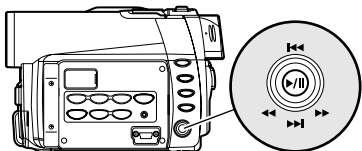

Tilt up/down and to left/right to select, and then press ►/|| to designate.

Note:

The brightness setting will be stored in memory even when the DVD video camera/recorder is turned off.

SETTING COLOR DENSITY OF LCD SCREEN (COLOR LEVEL)

- 1 Choose "Color Level" on the "LCD Setup" menu screen, and then press the ►/|| button.

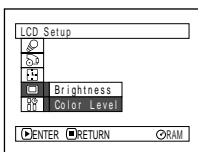

The color density adjustment bar will appear on the screen.

- 3 Press the MENU button.

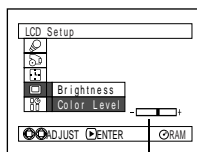

Color density adjustment bar

- 2 Use the joystick for adjustment.

- ⊖: For lighter color
- ⊕: For denser color

Note:

The color level setting will be stored in memory even when the DVD video camera/recorder is turned off.

Initial Settings

SWITCHING OPERATING SOUND ON OR OFF (BEEP)

This DVD video camera/recorder will emit a sound when the power switch is changed over, the REC button is pressed to record a movie, or other operations are engaged. If you do not need operating sound, you can switch it off.

Setting	Content
On	Beep is heard
Off	No beep is heard

- 1 Press the MENU button, choose "Beep" on the "Initial Setup" menu screen, and then press the ►/II button.

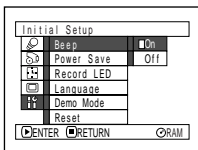

- 2 Select "On" or "Off", and then press the ►/II button.

- 3 Press the MENU button to end the setting.

Note:

The "Beep" setting will be stored in memory even when the DVD video camera/recorder is turned off.

TURNING DVD VIDEO CAMERA/RECORDER OFF AUTOMATICALLY (POWER SAVE)

This DVD video camera/recorder is equipped with power save function. Specify "Power Save: On": If the DVD video camera/recorder is left in the recording pause status without being operated for 5 minutes, it will automatically turn off to prevent the battery from discharging needlessly.

Setting	Content
On	To engage power save
Off	To cancel power save

- 1 Press the MENU button, choose "Power Save" on the "Initial Setup" menu screen, and then press the ►/II button.

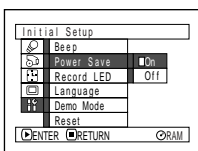

- 2 Select "On" or "Off", and then press the ►/II button.

- 3 Press the MENU button to end the setting.

Note:

- To turn the DVD video camera/recorder on again from automatic off activated by the power save function, set the power switch to "POWER OFF", and then set it to "VIDEO", "PHOTO" or "CARD PHOTO"
- The Power Save setting will not appear in the on-screen information display.
- The Power Save setting will be stored in memory even when the DVD video camera/recorder is turned off.

TURNING RECORD LED ON OR OFF (RECORD LED)

You can switch off the recording indicator on the front of DVD video camera/recorder even during recording.

Setting	Content
On	The recording indicator will light red to show that the DVD video camera/recorder is recording.
Off	The recording indicator will not light even during recording.

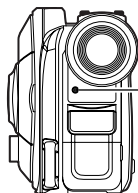

Recording indicator

- 1 Press the MENU button, choose “Record LED” on the “Initial Setup” menu screen, and then press the ►/II button.

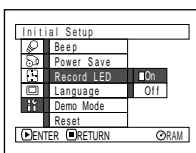

- 2 Select “On” or “Off”, and then press the ►/II button.

- 3 Press the MENU button to end the setting.

Note:

- The Record LED setting will not appear in the on-screen information display.
- The Record LED setting will be stored in memory even when the DVD video camera/recorder is turned off.
- Specify “Record LED: Off” when recording a subject behind a glass or water tank that reflects light: The reflected light of the recording indicator will not be recorded.
- When using the self-timer function, the recording indicator will blink when the REC button is pressed regardless of whether Record LED is On or Off.

CHANGING DISPLAY LANGUAGE (LANGUAGE)

You can change the language used to display the menu and information. The following shows that English is changed to French.

- 1 Press the MENU button, choose “Language” on the “Initial Setup” menu screen, and then press the ►/II button.

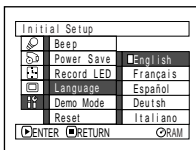

“English” has been set.

- 2 Select “Français”, and then press the ►/II button.

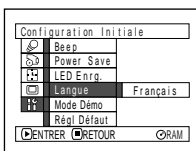

- 3 Press the MENU button to end the setting.

Note:

The language setting will be stored in memory even when the DVD video camera/recorder is turned off.

RESETTING MENU SETTINGS TO DEFAULTS (RESET)

You can restore menu settings to defaults (initial settings at the factory (P. 163)). (Note, however, that the date/time, brightness and color density of LCD monitor will not be reset.)

- 1 Press the MENU button, choose “Reset” on the “Initial Setup” menu screen, and then press the ►/II button.

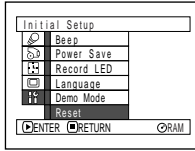

The screen for verifying reset will appear.

- 2 If you are sure that you wish to reset, use the joystick to choose “YES”, and then press the ►/II button.

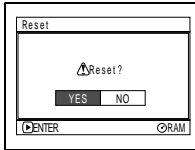

The setting items have now been reset to defaults.

- 3 Press the MENU button to end the setting.

Note:

To cancel resetting midway, choose “NO” on the screen for verification in step 2 or press the □ button.

Using Disc Navigation

STARTING DISC NAVIGATION

Disc Navigation is a tool for editing scenes recorded on this DVD video camera/recorder. Here is an explanation on “scene” and “program”, so that you will be able to make most use of Disc Navigation function.

The screens in this instruction manual are basically those that will appear when DVD-RAM disc is used: Some items will not appear when DVD-R disc or card is used, but the operation is the same.

- 1 Press the DISC NAVIGATION button.



The Disc Navigation screen (shown on page 96) will appear.

Note:

Do not proceed with a following step while the disc is being recognized or the ACCESS/PC indicator is blinking.

● **Thumbnail:**

This refers to a reduced image that helps to distinguish recorded scenes quickly. Immediately recording is finished, the first image of the recorded scene will be used as a thumbnail of the scene: The thumbnail can be changed later on this DVD video camera/recorder.

● **Scene:**

Movie (video): One scene refers to images recorded from one press of the REC button until recording is temporarily stopped by pressing REC again.

Still (photo): One scene refers to a photo recorded by pressing the REC button.

The following screen will appear when DVD-RAM disc is used: Some display components will not appear when DVD-R disc or card is used.

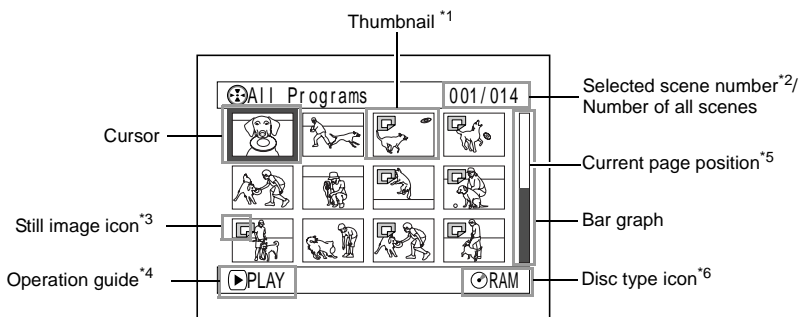

- *1 The displayed thumbnail will be the first image that you recorded.
- *2 Scene number refers to display number on thumbnail display screen.
- *3 No still icon will appear for card.
- *4 The operation guide will vary depending on the operation status of DVD video camera/recorder.
- *5 Appears when 13 scenes or more have been recorded.
- *6 "◉R" appears for DVD-R disc. "◻" will appear for card.

Note:

- The background color of screen allows you to identify whether disc or card is in DVD video camera/recorder.
 - Purple: When disc is inserted
 - Green: When card is inserted
- Pressing the DISPLAY button will display the recording date/time of the scene on which the cursor is placed in the space for operating guide. Pressing DISPLAY again will display the operating guide.
- If no disc or card is inserted, the Disc navigation screen cannot be displayed even by pressing the DISC NAVIGATION button.
- Each time Disc Navigation is started with a DVD-R disc inserted, message "Creating Thumbnail ..." will appear. After the message appears, the Disc Navigation screen will appear.
- If the following disc or card is inserted, the Disc Navigation screen will appear or some message will be displayed:
 - Write-protected disc
 - Locked card
 - Finalized DVD-R disc
- Do not leave the disc navigation screen displayed on TV to which the DVD video camera/recorder is connected: Doing so could damage the TV screen, possibly by burning.

TERMINATING DISC NAVIGATION

- 1 Press the DISC NAVIGATION button.

Disc Navigation will be terminated and the DVD video camera/recorder will enter the recording pause status.

You can also press the  button to end Disc Navigation.

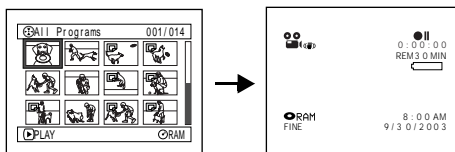

PLAYING BACK FROM DISC NAVIGATION SCREEN

- 1 Press the DISC NAVIGATION button.

- 2 Use the joystick to select the desired scene.

The selected scene will be framed: This is called a "cursor".

- 3 Press the  button.

Playback will start from the selected scene.

Note:

Tilting the joystick to left or right will move the cursor to the preceding or following scene.

Tilting it up or down will move to preceding or following page.

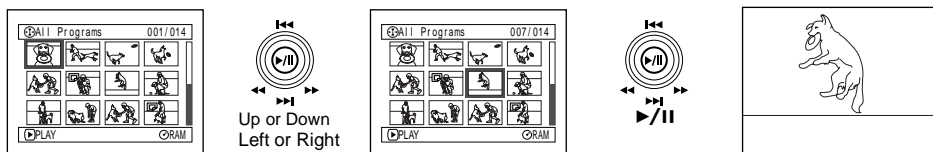

●When playback ends:

The DVD video camera/recorder will enter the playback pause status at the last image of last scene.



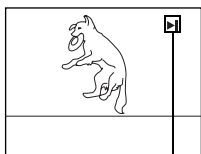

Pressing the  or DISC NAVIGATION button will restore the Disc Navigation screen.

When the playback pause status continues for as long as 5 minutes, the Disc Navigation screen will automatically be restored.



Playback pause

Note:

- Press the  button to temporarily stop playback. Pressing  again will start from that point.
- If you press the  button after playback of the last scene on disc finishes, playback will start again from the beginning of disc.
- Pressing the  button will always restore the Disc Navigation screen.
- With playback on Disc Navigation, you can select desired scenes for playback and skip unnecessary scenes.
- When playing back a still with a large number of pixels on card, "Playback." will appear, and it will take some time for the still to appear.

●Playing back stills

A still will be displayed for approx. 3 seconds.

When playing back stills on card, playback will stop after each still playback.

SELECTING MULTIPLE SCENES

- 1 Press the DISC NAVIGATION button.
- 2 Use the joystick to select the desired scene.
- 3 Press the SELECT button once:

The selected scene will be framed in red and yellow.

Repeat steps 2 and 3 to randomly select multiple scenes.

To cancel a selected scene, select the scene to be canceled, and then press the SELECT button.
To cancel all selected scenes, press the button.

Note:

Although scenes can be randomly selected, playback will always start from the lowest scene number.

SELECTING CONSECUTIVE SCENES TOGETHER

- 1 Press the DISC NAVIGATION button.
- 2 Use the joystick to select the desired scene.

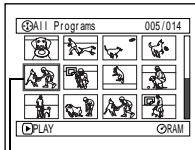

Yellow frame

- 3 Hold down the SELECT button for at least one second:

The selected scene will be doubly framed in yellow and blue.

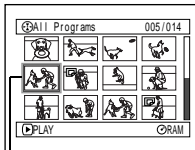

Double frames in yellow and blue

- 4 Use the joystick to select the last scene in the range you want, and then press the ►/|| button:

The thumbnails of scenes in the specified range will be framed in red, and then selected.

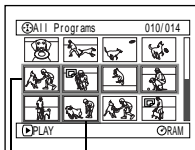

Red frame

When scenes up to this point are selected

Note:

- You can know the status of scenes from the colors of cursor and bargraph:

Cursor	Bar graph	Status of scenes
Yellow	Blue	Current cursor position
Blue	Blue	Range of scenes being selected
Red	Red	Scenes already selected

- Pressing the ►/|| button after selecting scenes will play back only the selected scenes from the beginning of each.
- You can also select scenes in reverse from the last scene in the range.
- To release multiple selection, press the SELECT or button after step 4.
- Up to 999 scenes can be selected for both disc and card.

Disc Navigation Menu

FUNCTIONS AVAILABLE WITH DISC NAVIGATION

Disc Navigation allows you to do the following:

Available function	Disc or card used	Contents	Reference page
Deletion of scenes	RAM CARD	You can delete unnecessary scenes.	101
Editing of scenes	RAM	You can attach fade and skip to a scene, combine scenes, or divide one scene.	103 - 108
Scene information display	RAM R CARD	You can display information on one scene or multiple scenes, such as image quality, recording time, etc.	113
Setting of title	RAM	You can set desired titles to play lists and programs.	115, 124
Creation of play list	RAM	You can create an original movie by changing the combination of scenes.	117
Disc or Card initialization	RAM CARD	You can initialize a DVD-RAM disc or card so that it can be used on this DVD video camera/recorder.	127
Copy from disc to card	RAM CARD	You can copy photos recorded on DVD-RAM disc to card.	109
Disc finalization	R	You can use this DVD video camera/recorder to finalize any DVD-R disc recorded on it so that the disc can be viewed on DVD player, etc.	129
Repeat play	RAM R	You can repeatedly play back programs and scenes.	130
Slide show	CARD	You can play back stills continuously.	131
Remaining display (Capacity)	RAM R CARD	The remaining recordable movie time or number of recordable stills is displayed.	126
Disc protection	RAM	You can protect the DVD-RAM disc to prevent deletion or editing by mistake.	126
Scene lock	CARD	You can lock any scene so that it will not be deleted by mistake: Essential scenes are thereby protected, and recording another still is possible.	110
DPOF setting	CARD	You can set the number of prints for each scene.	111

UNDERSTANDING FLOW OF DISC NAVIGATION MENU

Press the MENU button on the Disc Navigation screen: The menu screens for Disc Navigation and menu screens for disc and card will appear.

See pages 78-79 and 96 for how to interpret the screen.

Refer to pages indicated for details of settings.

● When using DVD-RAM disc

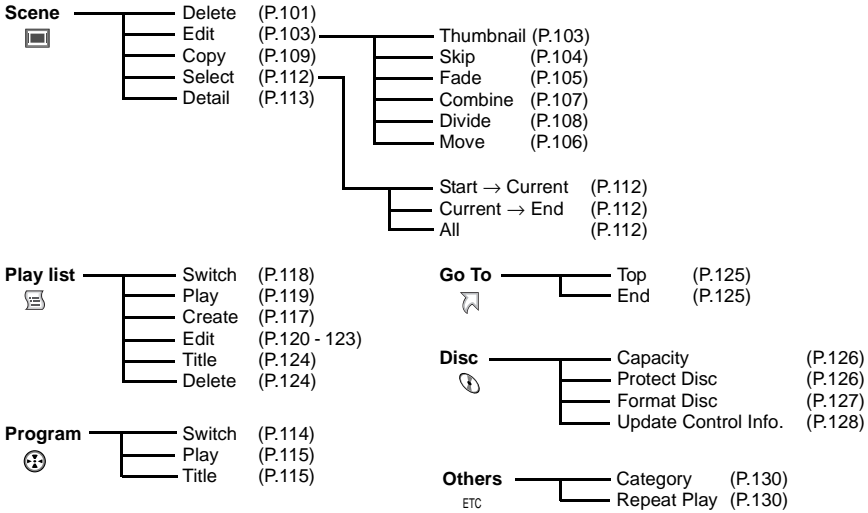

● When using DVD-R disc

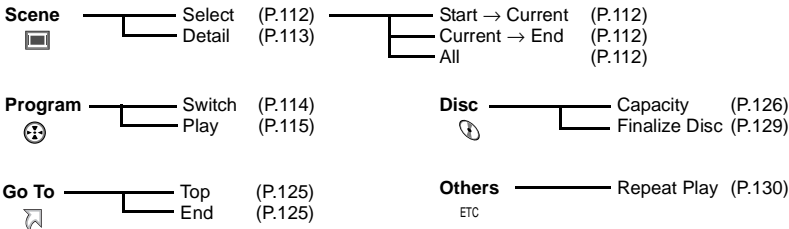

● When using card

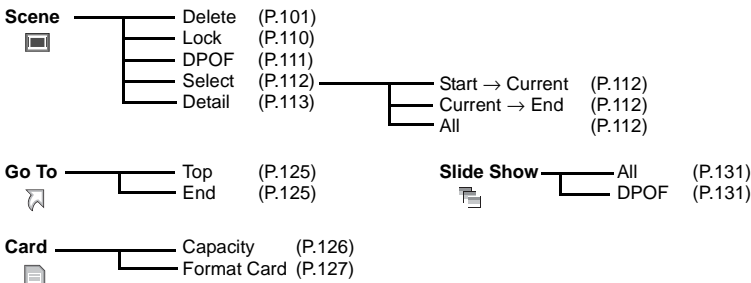

DELETING SCENES (DELETE)

1 Press the DISC NAVIGATION button.

2 Select the scene to be deleted.

3 Press the MENU button.



Scene to be deleted

4 Choose "Delete" on the "Scene" menu screen, and then press the ►/II button.

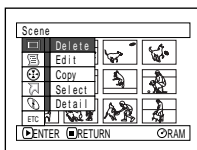

5 The "Delete Scene" screen will appear: If you are sure you want to delete the selected scene, press the ►/II button.

If you want to change the scene to be deleted, you can change it on this screen.

6 The screen for verifying deletion will appear: Choose "YES", and then press the ►/II button.

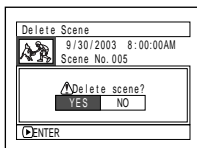

Choose "NO" to cancel deletion.

After Yes or No setting, the "Delete Scene" screen will be restored. Repeat steps 5 and 6 to delete other scenes.

7 Press the □ button to quit.

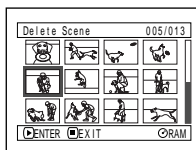

Note:

- If you point the cursor at the scene to be deleted on "All Programs" screen, and then press the DELETE button on remote control, the screen in step 5 will appear.
- If you delete all data on disc or card, initializing the disc or card will be recommended (See page 127).
- If even one play list has been created, message "Same scenes on PlayList will be deleted. Delete scenes?" will appear before deleting scene(s). This message will appear even if the scene(s) to be deleted is not used in the corresponding play list. In this case, choose "YES" and then press the ►/II button.
- If the time of deleted scenes (stills) is quite short, the remaining free space of disc may not increase in the disc or card remaining indicator.
- The locked scenes on card cannot be deleted (See page 110).

● Editing using submenu

Press the MENU button before pressing the ►/|| button in step 5 (See page 101): The submenu will appear.

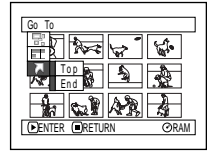
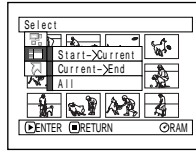
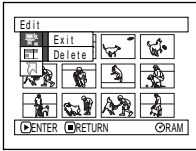

- Edit ———— Exit..... To restore the Disc Navigation screen
- Delete To delete selected scenes
- Select ———— Start→Current... To select scenes from the start to the one that the cursor is on at the moment
- Current→End.... To select scenes from the scene the cursor is on to the end
- All To select all scenes
- Go To ———— Top To move the cursor to the first scene
- End..... To move the cursor to the last scene

Pressing the □ button will restore the screen in step 5.

Note:

Although the submenu screen will appear for each setting, some menu items may not appear, depending on the setting.

CHANGING IMAGES FOR THUMBNAILS (EDIT - THUMBNAIL)

The thumbnail refers to a reduced image displayed on Disc Navigation to help distinguish recorded scenes. Normally, the first image of the recorded scene is displayed as a thumbnail: You can choose another image of the scene for thumbnail. If you set a vivid image to thumbnail, you can know what you recorded from a glance at the Disc Navigation screen.

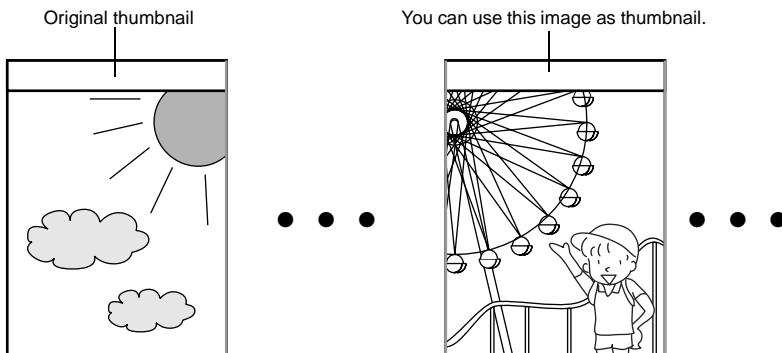

- 1 Press the DISC NAVIGATION button.
- 2 Select the thumbnail of the scene to be changed.
- 3 Press the MENU button.
- 4 Choose “Scene”, “Edit”, “Thumbnail”, and then press the ►/|| button.

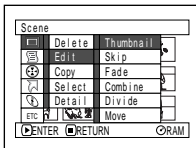

- 5 The “Change Thumbnail” screen will appear: If you are sure you want to change the thumbnail of the selected scene, press the ►/|| button: The selected scene will be played back.

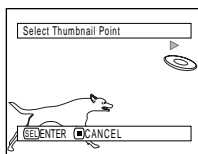

If you want to change the scene whose thumbnail is to be changed, you can change it on this screen.

- 6 When the image you want to use as the thumbnail of the scene appears, press the SELECT button.

You can use this image as thumbnail.

- 7 The screen for verifying switching of thumbnail will appear: Choose “YES”, and then press the ►/|| button.

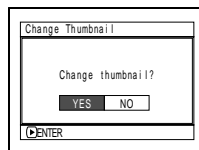

Choose “NO” to cancel switching of thumbnail. After Yes or No setting, the “Change Thumbnail” screen will be restored. Repeat steps 5-7 to change the other scenes.

- 8 Press the □ button to quit.

Note:

- If you press the MENU button before pressing the ►/|| button in step 5, the submenu screen will appear. (See page 102)
- A thumbnail of still cannot be changed.
- Since the scene to which skipping is set cannot be played back, you will not be able to change its thumbnail: Release the skip setting of the scene to change the thumbnail.

PLAYING BACK BY SKIPPING SCENES (EDIT - SKIP)

You can specify “Skip” for scenes you do not want to play back: The selected scenes will be skipped.

- 1 Press the DISC NAVIGATION button.
- 2 Select the scene to be skipped.
- 3 Press the MENU button.
- 4 Choose “Scene”, “Edit”, “Skip”, and then press the ►/|| button.
- 5 The “Set Skip” screen will appear: If you are sure you want to skip the selected scene, press the ►/|| button.

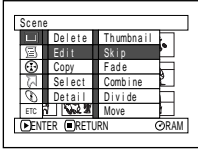

● Releasing Skip

Select the scene set to be skipped, and perform the same procedure as setting skip: The skip mark will disappear and skipping of the scene will be released.

Note:

- Multiple scenes can be selected for skipping (P.98).
- If you press the MENU button before pressing the ►/|| button in step 5, the submenu screen will appear (P.102).

If you want to change the scene to be skipped, you can change it on this screen. After skip setting, the “Set Skip” screen will be restored. Repeat step 5 to set skipping of other scenes.

- 6 Press the □ button to quit.

A skip mark “” will appear in the thumbnail of any scene for which skipping has been set.

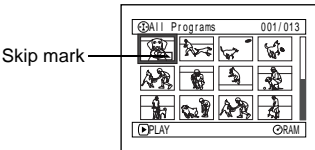

ADDING SPECIAL EFFECTS (EDIT - FADE)

You can add fading to the beginning and/or end of scene. There are three types of special effects:

Fade Out

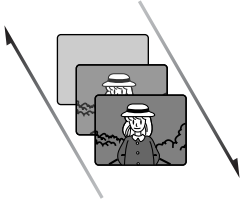

Fade In

Fade Out

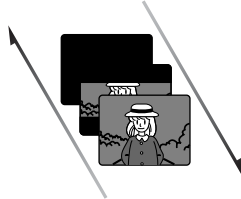

Fade In

Fade Out

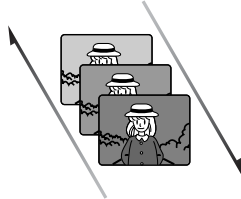

Fade In

White:

Fades in from white screen
Fades out to white screen

Wipe:

Fades in from black screen to vertical direction of screen
Fades out from vertical direction of screen to black screen

B/W:

Fades in from Black and White screen to color screen
Fades out from color screen to Black and White screen

- 1 Press the DISC NAVIGATION button.
- 2 Select the scene for adding special effects.
- 3 Press the MENU button.

7 Press the button to quit.

4 Choose, "Scene", "Edit", "Fade" and then press the ►/|| button.

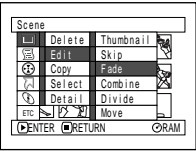

5 The "FadeSet" screen will appear: If you are sure you want to add the fade effect to the scene, press the ►/|| button.

The "▲" and/or "▼" mark(s) will appear in the scenes for which special effects have been set.

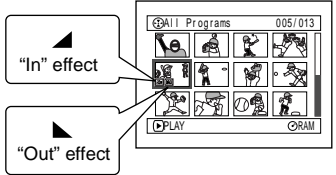

If you want to change the scene to which fade is added, you can change it on this screen.

6 Select the special effects for "IN" and/or "OUT", choose "Enter", and then press the ►/|| button.

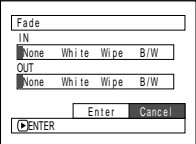

To cancel setting, choose "Cancel".

After setting, the "Fade Set" screen will be restored.

Repeat steps 5 and 6 to add fade to other scenes.

When playing back

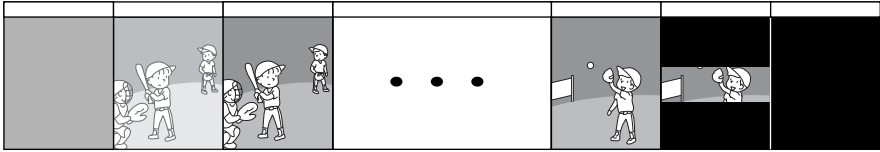

Note:

- Setting fade will interlock with sound.
- Fading can also be set to either "IN" or "OUT".
- Any registered fade can be changed at any time using the same procedure as above.
- Fade can also be added to on-screen information displayed during playback.
- Adding fade to multiple scenes is also possible.
- If the playback time of scene is short, fade will cut off midway.
- If you set fade-in and fade-out to a still image or a movie with recording time of no more than 3 seconds, only fade-in will be valid.
- No fade effect will operate if you start playback in the recording pause status.
- If you locate the start of a scene by skipping, the image at the start of the scene will appear for a moment, and then fade will operate.
- The fade effect will not function during frame advance, frame back, slow playback or search playback.

RAM

ARRANGING ORDER OF SCENES (EDIT - MOVE)

You can arrange scenes within a play list by moving them to desired positions. Create a play list first, and then arrange the scenes ["Creating New Play List (Create)", P.117].

COMBINING MULTIPLE SCENES (EDIT - COMBINE)

You can combine multiple scenes into one.

If you have recorded numerous short scenes, combining them will be facilitated by the use of Disc Navigation.

Be sure to select consecutive multiple scenes. Combining scenes is possible only when "Category: All" is specified. Stills cannot be combined.

- 1 Press the DISC NAVIGATION button.
- 2 Select the consecutive multiple scenes to be combined.

- 3 Press the MENU button.

- 4 Choose, "Scene", "Edit", "Combine" and then press the ►/|| button.

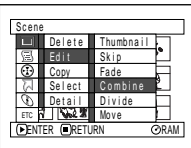

- 5 The "Combine Scenes" screen will appear: If you are sure you want to combine the selected scenes, press the ►/|| button.

If you want to change the scenes to be combined, you can change them on this screen.

- 6 The screen for verifying combination will appear: Choose "YES", and then press the ►/|| button.

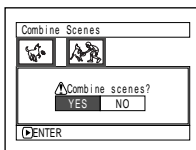

The two images appearing on the verification screen are those of the first and last scenes to be combined.

Choose "NO" to cancel combination.

After Yes or No setting, the "Combine Scenes" screen will be restored.

The thumbnail of the first scene will appear in the combined scene.

Repeat steps 5 and 6 to combine other scenes.

- 7 Press the □ button to quit.

Note:

- If you press the MENU button before pressing the ►/|| button in step 5, the submenu screen will appear. (P.102)
- With special effects, the "IN" effect of the first scene in the selected range and the "OUT" effect of the last scene will be chosen.
- If you combine scenes from different programs (different recording dates), a message that prompts you to update the control information will appear when power is turned on and Disc Navigation is first started (P.128). Note that if you choose "YES" for this message, the combined scenes will be split into separate scenes. If you choose "NO" for this message, the scenes will be combined, but the same message will appear each time Disc Navigation is started. To prevent this, when combining scenes from different programs, create a new play list and combine the scenes on it.

DIVIDING MOVIES (EDIT - DIVIDE)

You can divide a scene into two parts.

To delete unnecessary portion of scene, first divide the scene, and then delete the unnecessary portion. You can also cut out a part of scene and use it in the play list.

1 Press the DISC NAVIGATION button.

2 Select the scene to be divided.

3 Press the MENU button.

4 Choose, "Scene", "Edit", "Divide" and then press the ►/|| button.

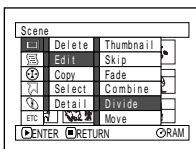

5 The "Divide Scene" screen will appear: If you are sure you want to divide the selected scene, press the ►/|| button: The selected scene will be played back.

If you want to change the scene to be divided, you can change it on this screen. The selected scene will be played back.

6 When you reach the point where you want to divide the scene, press the SELECT button.

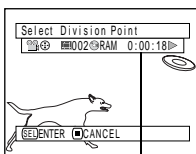

Status bar of scene being played back

7 The screen for verifying division will appear: Choose "YES", and then press the ►/|| button.

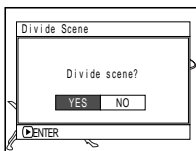

Choose "NO" to cancel division.

After division, the "Divide Scene" screen will be restored.

Repeat steps 5-7 to divide another scene.

8 Press the □ button to quit.

Note:

- If you press the MENU button before pressing the ►/|| button in step 5, the submenu screen will appear. (P.102)
- The status bar of scene being played back can be switched off or on by pressing the DISPLAY button.
- Search and frame advance are useful when designating division points.
- If a special effect has been added to the original scene, the "IN" effect will be added to the first half of scene, and the "OUT" effect, to the latter half.
- The division point may drift before or after the designated point by approximately 0.5 seconds.
- Since a scene with a skip set cannot be played back, no division point can be specified: Release the skip for the scene before dividing it.
- If the division point is at a still, a message will appear, but no division will be made.
- If the division point is at the start or end of a scene, a message will appear, but no division will be made.
- A movie scene whose recording time is 0.5 seconds or less cannot be divided.
- If free space available on disc is insufficient, division will not be possible: Delete unnecessary scenes.
- Pressing the □ button on the screen for verification will restore the thumbnail display screen.

COPYING STILLS ON DVD-RAM DISC TO CARD (COPY)

You can copy stills recorded on DVD-RAM disc to card.

1 Set the power switch to “ VIDEO” or “ PHOTO”.

2 Press the DISC NAVIGATION button.

3 Select the still to be copied.

4 Press the MENU button.

5 Choose “Copy” on the “Scene” menu screen, and then press the /|| button.

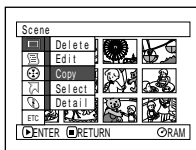

6 The “Copy to card” screen will appear: If you are sure you want to copy the selected still, press the /|| button.

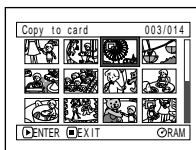

If you want to change the still to be copied, you can change it on this screen.

7 The screen for verifying copy will appear: Choose “YES”, and then press the /|| button.

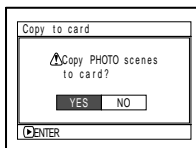

Choose “NO” to cancel copy.

After Yes or No setting, the “Copy to card” screen will be restored.

Repeat steps 6 and 7 to copy other stills to card.

8 Press the button to quit.

Note:

- No movie can be copied.
- If you press the MENU button before pressing the /|| button in step 6, the submenu screen will appear. (P.102)
- See “Category” (P.130) to check the stills recorded on DVD-RAM disc.
- You can also select multiple scenes (P.98).
- Even if all scenes, including movies, are selected to be copied, only stills will be copied.
- Data on card cannot be copied to disc.
- The quality of still copied from disc to card will be the same as when you recorded still on disc.
- Stills recorded on a device other than this DVD video camera/recorder may not be copied normally.

LOCKING SCENES ON CARD (LOCK)

You can lock each photo recorded on card so that it will not be deleted or edited by mistake.

- 1 Set the power switch to "CARD PHOTO".
- 2 Press the DISC NAVIGATION button.
- 3 Select the scene to be locked.
- 4 Press the MENU button.
- 5 Choose "Lock" on the "Scene" menu screen, and then press the ►/II button.
- 6 The "Lock Set" screen will appear: If you are sure you want to lock the selected scene, press the ►/II button.

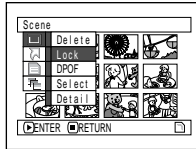

● To unlock the scene:

Select the locked scene, and then use the same procedure as above to unlock the scene: The lock mark will disappear and locking will be released.

Note:

- If you press the MENU button before pressing the ►/II button in step 6, the submenu screen will appear. (P.102)
- You can also select multiple scenes (P.98).
- When initializing the card, the locked scenes will also be deleted.

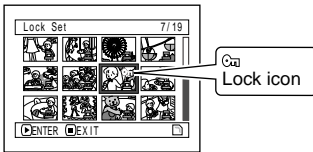

If you want to change the scene to be locked, you can change it on this screen.

After setting, the "Lock Set" screen will be restored.

Repeat step 6 to lock another scene.

- 7 Press the □ button to quit.

DESIGNATING SCENES TO BE PRINTED (DPOF)

You can use DPOF to set print information, including selection of the scenes to be printed, so that you will be able to use it on a system conforming to DPOF.

Note:

DPOF stands for digital print order format. DPOF is used to ask a print lab to print recorded stills.

- 1 Set the power switch to "CARD PHOTO".
- 2 Press the DISC NAVIGATION button.
- 3 Select the scene to which DPOF is to be set.
- 4 Press the MENU button.
- 5 Choose "DPOF" on the "Scene" menu screen, and then press the ►/|| button.
- 6 The "DPOF Set" screen will appear: If you are sure you want to set DPOF to the scene, press the ►/|| button.

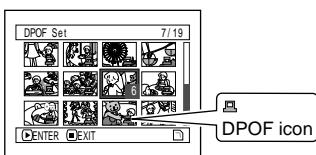
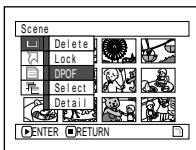

If you want to change the scene to which DPOF is set, you can change it on this screen.

- 7 Use joystick to specify the number of prints, and then press the ►/|| button:

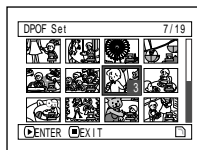

Tilt it up or to right: To increase the number one by one.

Tilt it down or to left: To decrease the number one by one.

After setting, the "DPOF Set" screen will be restored.

Repeat steps 6 and 7 to set DPOF to another still.

- 8 Press the □ button to quit.

Note:

- If you press the MENU button before pressing the ►/|| button in step 6, the submenu screen will appear. (P.102)
- You can also select multiple photos (P.98).
- If you specify the number after selecting multiple stills, the same specified number will be set to all those stills.
- Up to 99 prints can be set for one scene. The maximum number of settable prints on one card is 999.
- This DVD video camera/recorder may not recognize DPOF that has been set on another device: Always set the DPOF on this DVD video camera/recorder.

SELECTING SCENES USING MENU SCREEN (SELECT)

Using the Disc Navigation menu screen, you can simultaneously select consecutive scenes. This function is useful when there are numerous scenes.

- 1 Press the DISC NAVIGATION button.
- 2 Select the first scene to be selected.
- 3 Press the MENU button.
- 4 Choose "Select" on the "Scene" menu screen.
- 5 Choose "Start → Current", "Current → End" or "All" and then press the ►/|| button.

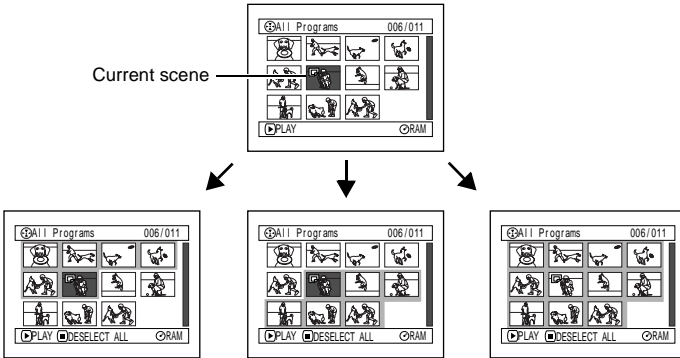
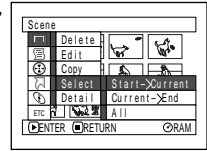

"Start → Current" is specified:
The scenes from the first to current will be selected.

"Current → End" is specified:
The scenes from the current to end will be selected.

"All" is specified:
All scenes from the first to end will be selected

● Deselecting selected scenes

Deselecting scenes one by one:

While you are displaying the "All Programs" screen on which scenes have been selected, choose the scene to be deselected and then press the SELECT button.

Deselecting all the selected scenes at once:

While you are displaying the "All Programs" screen on which scenes have been selected, press the □ button.

Note:

Up to 999 scenes can be selected.

DISPLAYING INFORMATION USING MENU SCREEN (DETAIL)

You can display various information for a scene: the recording mode, recording date/time and length, special effects and movie quality mode.

- 1 Press the DISC NAVIGATION button.
- 2 Select the scene whose information you wish to know.
- 3 Press the MENU button.
- 4 Choose "Scene", "Detail", and then press the ►/II button.

The detailed information on the scene will appear.

(When using disc)

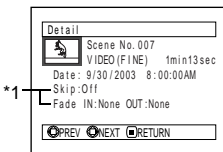

(When using card)

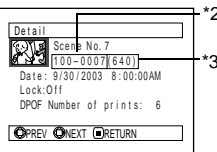

- *1 Not displayed with DVD-R disc.
- *2 May not appear if the loaded card does not comply with DCF.
- *3 Number of pixels on still in horizontal direction: This may not appear with a JPEG file that does not conform to this DVD video camera/recorder.

Note:

Tilting the joystick to right will display information on the following scene; tilting the joystick to left will display information on the preceding scene.

- 5 Press the □ button to quit.

If you have selected multiple scenes, the information shown below will appear. Pressing the □ button will restore the thumbnail display screen.

(When using disc)

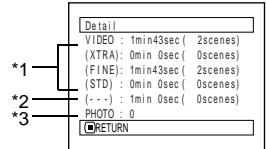

- *1 With DVD-R disc, the quality mode (FINE, STD or LPCM) selected first will appear.
- *2 Number of scenes whose quality mode is unknown: This will appear when the disc has a scene recorded on a device other than this DVD video camera/recorder, only if the disc has a scene whose mode is unknown. Also, this will not appear when a DVD-R disc is used.
- *3 This will not appear with DVD-R disc, since no still image can be recorded on it.

(When using card)

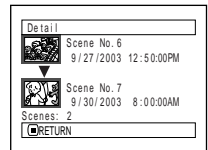

Note:

- If multiple scenes have been selected, the total recording time of the selected scenes (total number in case of stills) will appear.
- If a DVD-R disc recorded on a device other than this DVD video camera/recorder is inserted (already finalized), no scene information will appear.

Program

WHAT IS “PROGRAM”?

Program refers to an assembly of scenes recorded on the same date regardless of whether they are movie or still.

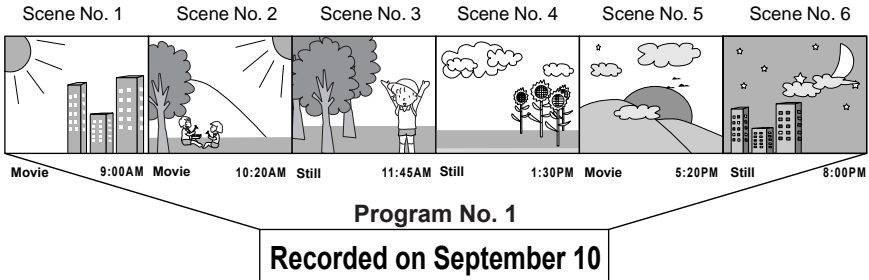

RAM R

SWITCHING TO THUMBNAIL DISPLAY OF SPECIFIC DATE (SWITCH)

Since the scenes recorded on this video camera/recorder are collected as “programs” for each recording date, selecting a program will allow you to display only the scenes on a specific date.

- 1 Press the DISC NAVIGATION button.
- 2 Press the MENU button.
- 3 Choose “Switch” on the “Program” menu screen, and then press the ►/II button.

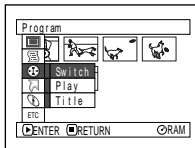

- 4 Select the program to be displayed, and then press the ►/II button.

The Disc Navigation screen of the selected program will appear.

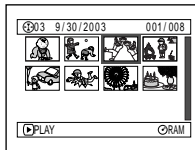
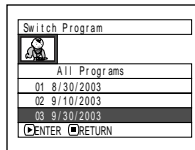

Note:

- Pressing the □ button on the “Switch Program” screen will restore the Disc Navigation screen.
- The dates displayed on the program select screen will be in the Date Mode used when the first scenes of programs were recorded, and the date displays M/D/Y, D/M/Y and Y/M/D may be mixed.

PLAYING BACK PROGRAM (PLAY)

You can play back only the selected program.

- 1 Press the DISC NAVIGATION button.
- 2 Press then the MENU button.
- 3 Choose "Play" on the "Program" menu screen, and then press the ►/|| button.

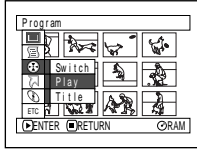

- 4 Select the program to be played back, and then press the ►/|| button.

Playback will start from the first scene of the selected program.

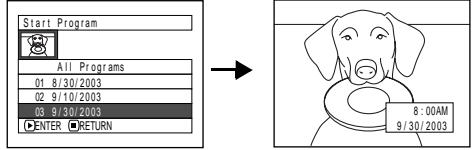

Note:

If "Repeat Play: On" is specified, the selected program will be repeatedly played back.

CHANGING TITLE OF PROGRAM (TITLE)

The recording date/time has initially been attached to any program. You can change the recording date/time to any desired title.

- 1 Press the DISC NAVIGATION button.
- 2 Press the MENU button.
- 3 Choose "Title" on the "Program" menu screen, and then press the ►/|| button.
- 4 Select the program whose title you want to change, and then press the ►/|| button.

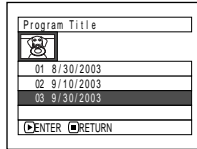

The screen for setting a title will appear.

- 5 Select a letter and then press the ►/|| button: The selected letter will be entered.

Repeat this procedure to create a title.

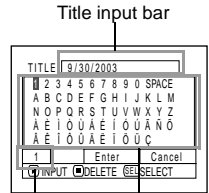

Input mode
Palette for selecting characters

6 After entering the title, choose “Enter” and then press the ►/|| button.

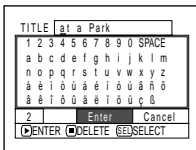

7 The screen for verifying the change in title will appear: Choose “YES”, and then press the ►/|| button.



Choose “NO” to cancel changing of the title.

After Yes or No setting, the Disc Navigation screen of the selected program will appear.

Note:

- If you wish to delete the letter for title, press the □ button once: The input letter will be deleted. Holding down the □ button will delete all letters in the TITLE column. You can also use the DELETE button on remote control to delete any input letters.
- Pressing the SELECT button on the title setting screen (in step 5) will change the cursor position from the title input bar to character select palette, input mode number, and then to “Cancel”.
- To cancel the setting of title, choose “NO” on the screen for verifying the entered title: The screen for verifying cancellation of title setting will appear. To cancel title setting, choose “YES”.
- If you press the □ button on the screen for verifying change in title, the title setting screen will be restored.
- Double byte characters set on other devices may be displayed blank on this DVD video camera/recorder.
- Titles set on this DVD video camera/recorder may not be visible on other devices.

● Characters available for entering title

You can use the joystick to select characters from the “capital letter”, “small letter” and “symbol” input modes.

With step 5, select the input mode and then press the ►/|| button, or press the DISPLAY button.

Input mode

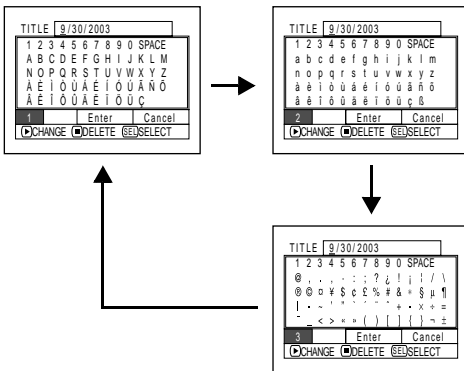

Play List

WHAT IS “PLAY LIST”?

You can create a play list on this DVD video camera/recorder by gathering your favorites from the recorded scenes.

Since the play list is not created by copying data, you will consume little of the disc capacity by making a play list. On the other hand, deleting scenes on play list will not increase the remaining disc capacity for recording.

Example:

Program 1 (recorded on September 27, 2003)



Program 2 (recorded on September 30, 2003)



Play list 1 created

Play lists of up to No. 99 can be created and 999 scenes can be included in play lists of No. 1 to No. 99.

CREATING NEW PLAY LIST (CREATE)

Here we create a play list.

- 1 Press the DISC NAVIGATION button.
- 2 Select the scenes to be programmed in a play list.
- 3 Press the MENU button.

- 4 Choose “Create” on the “PlayList” menu screen, and then press the ►/II button.

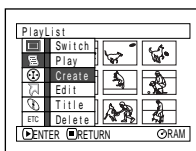

- 5 The scene select screen will appear: If the selected scenes on the play list are the ones you want, press the ►/II button.

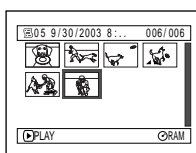

If you want to change the scenes with which you want to create a play list, you can change them on this screen.

With the created play list, you can also add scenes recorded on another day or delete unnecessary scenes afterwards.

- 6 When creation of a play list is complete, the Disc Navigation screen will appear.

Note:

- You can also select multiple scenes (P.98).
- If the added scene had skip or fade setting, that information will also be added to the play list.
- The date/time when a play list was created will appear as the title for the play list.
- If free space available on disc is insufficient, creation of new play list may not be possible: Delete unnecessary scenes.
- Only the data on scenes is recorded on play list: If you create or delete play lists, the original scenes in programs will not be erased. Editing scenes on play list will not affect the scenes in programs.

● Editing on play list

When making settings on play list, such as changing title, adding fade, setting skip, etc., use the same procedure for setting on program or scenes. Perform these settings, referring to the following reference pages:

Setting skip,	P.104
Adding fade,	P.105
Combining scenes,	P.107
Dividing a scene,	P.108
Changing title,	P.115

SWITCHING TO DISPLAY OF EACH PLAY LIST (SWITCH)

Select the desired one of multiple play lists: The Disc Navigation screen of the selected play list will appear.

- 1 Press the DISC NAVIGATION button.
- 2 Press the MENU button.
- 3 Choose “Switch” on the “PlayList” menu screen, and then press the ►/II button.

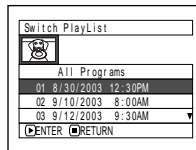
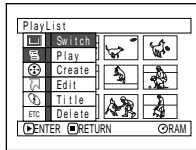

- 4 Use the “Switch Playlist” screen to select the play list you wish to display, and then press the ►/II button.

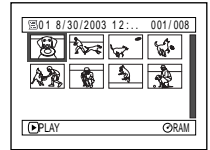

The Disc Navigation screen of the selected play list will be displayed.

Note:

To display the Disc Navigation screen showing all programs (all recorded scenes), choose “All Programs” on the “Switch PlayList” screen.

PLAYING BACK A PLAY LIST (PLAY)

- 1 Press the DISC NAVIGATION button.
- 2 Press the MENU button.
- 3 Choose “Play” on the “PlayList” menu screen, and then press the ►/II button.

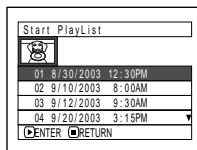
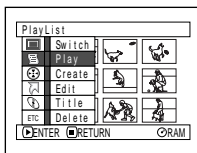

- 4 Use the “Start Playlist” screen to select the play list to be played back, and then press the ►/II button.

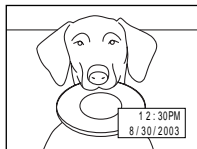

The selected play list will be played back from the first scene. To cancel playback midway, press the □ button: The Disc navigation screen of the play list being played back will appear.

Note:

If “Repeat Play On” is specified, the play list will be repeatedly played back (See page 130).

ADDING SCENES TO PLAY LIST (EDITING PLAY LIST)

You can later add scenes to the play list.

- 1 Press the DISC NAVIGATION button.
- 2 Press the MENU button.
- 3 Choose "Edit" on the "PlayList" menu screen, and then press the ►/|| button.

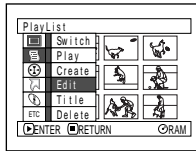

- 4 Use the play list select screen to select the play list to which you wish to add scenes, and then press the ►/|| button.

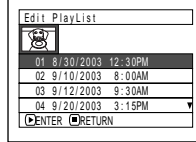

The scenes of the program that was displayed in step 1 will appear in the upper row, and the scenes of selected play list will appear in the lower row.

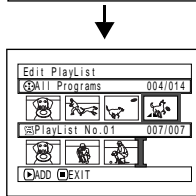

Note:

If the DISPLAY button is pressed when the thumbnails are displayed, the recording date/time of the selected scene will appear across the bottom of screen. Press DISPLAY again to restore the previous screen.



Recording date/time

- 5 Tilt the joystick down to move the cursor to the lower row, and tilt it to left or right to select the point where the scene is to be inserted.

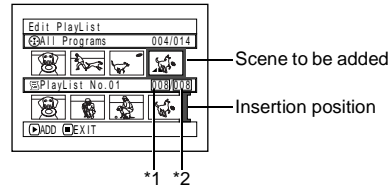

- *1: Number of scene before insertion position cursor
- *2: Number of all scenes on play list

- 6 Tilt the joystick up to move the cursor to the upper row, and tilt it to left or right to point the cursor to the scene to be added.

- 7 Press the ►/|| button to copy the scene.

After adding scenes is completed, the edited play list will appear.
Repeat steps 5-7 to add other scenes.

- 8 Press the □ button: The screen for verifying exit will appear.

Note:

- The cursor shows the position where the scene is to be added.
- You can also select multiple scenes (P.98).
- Pressing □ in the middle of adding scenes will display the screen for verifying an exit from "Edit PlayList". Choose "YES" to exit the edition of play list. Choosing "NO" will restore the "Edit PlayList" screen.
- If you press the MENU button in step 5 or 6, the submenu screen for editing play list will appear. You can also use this submenu to add scenes (See page 102).

DELETING SCENES FROM PLAY LIST (EDITING PLAY LIST)

1 Press the DISC NAVIGATION button.

2 Display the editing screen of the play list to be edited.

Perform steps 2–4 on page 120.

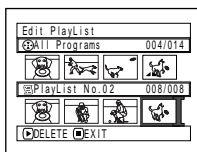

3 Move the cursor to the play list in lower row, and place the cursor on the scene to be deleted.

4 Press the ►/|| button.

Repeat steps 3 and 4 to delete other scenes.

5 Press the □ button: The screen for verifying exit will appear.

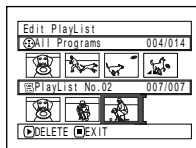

Note:

- You can also select multiple scenes (P.98).
- Place the cursor on scene to be deleted, and then press the DELETE button on remote control: You can also delete the scene on the play list.

ADDING SCENES USING SUBMENU FOR EDITING (EDITING PLAY LIST)

You can use the menu screen to add scenes to a play list.

1 Press the DISC NAVIGATION button.

2 Display the editing screen of the play list to be edited.

Perform steps 2–4 on page 120.

3 From the play list in lower row, select the position where you wish to insert a scene.

4 Select the scenes to be added from the upper row.

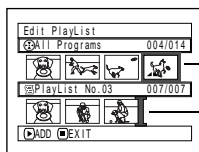

Scene to be added
Insertion position

5 Press the MENU button.

6 Choose "Add", and then press the ►/|| button.

Repeat steps 3-6 to add other scenes.

7 Press the □ button to quit.

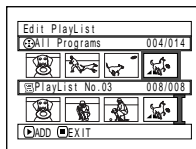
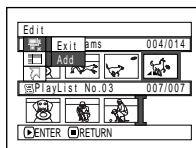

Note:

- The selected scenes will be added in the insertion position.
- You can also select multiple scenes (P.98).

DELETING SCENES USING SUBMENU FOR EDITING (EDITING PLAY LIST)

You can delete scenes from play list on the editing screen.

1 Press the DISC NAVIGATION button.

2 Display the editing screen of the play list to be edited.

Perform steps 2–4 on page 120.

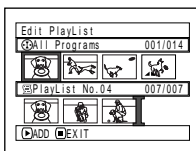

3 Move the cursor to the play list in lower row.

4 Select the scene to be deleted, and then press the MENU button.

5 Choose “Delete” on the “Edit” menu screen, and then press the ►/|| button.

Repeat steps 3-5: other scenes can be deleted.

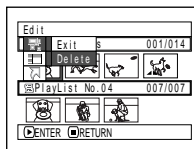

6 Press the □ button: The screen for verifying exit will appear.

Note:

- If all scenes on play list are deleted, the play list itself will also be deleted.
- You can also select multiple scenes (P.98).

SELECTING SCENES USING SUBMENU FOR EDITING (EDITING PLAY LIST)

You can specify the range of scenes when adding or deleting consecutive multiple scenes to/from play list. This “Select” menu item is useful when selecting consecutive multiple scenes in items for adding or deleting scenes using menu on page 112.

1 Press the DISC NAVIGATION button.

2 Display the editing screen of the play list to be edited.

Perform steps 2–4 on page 120.

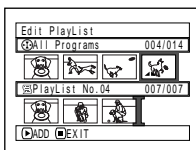

3 Specify the first scene of those you wish to select, and then press the MENU button.

4 Choose “Start→Current”, “Current→End”, “All” on the “Select” menu screen, and then press the ►/|| button.

Note:

See page 112 for the status of scenes to be selected.

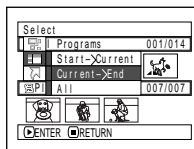

5 Press the □ button: The screen for verifying exit will appear.

ARRANGING ORDER OF SCENES (MOVE)

You can move scenes only when “Category: All” is specified.

- 1 Press the DISC NAVIGATION button.
- 2 Press the MENU button.
- 3 Choose “Switch” on the “PlayList” menu screen, and then press the ►/|| button.
- 4 Select the scene to be moved.
- 5 Press the MENU button.
- 6 Choose “Scene”, “Edit”, “Move”, and then press the ►/|| button.
- 7 The “Move Scenes” screen will appear: If you are sure you want to move the scene, press the ►/|| button.

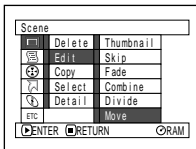

If you want to change the scene to be moved, you can change it on this screen.

- 8 Move the “I” mark to the position where you wish to move the scene, and then press the ►/|| button.

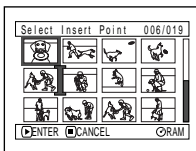

- 9 The screen for verifying move will appear: Choose “YES”, and then press the ►/|| button.

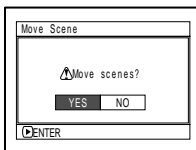

Choose “NO” to cancel move.

After Yes or No setting, the scene select screen will be restored.

Repeat steps 7 - 9 to move another scene.

- 10 Press the □ button to quit.

Note:

- If you press the MENU button before pressing the ►/|| button in step 7, the submenu screen will appear.
- You can also move multiple scenes (P.98).
- Stills can also be moved.
- Only scenes on play list can be moved.

CHANGING TITLE OF PLAY LIST (TITLE)

The play lists have serial numbers in the order you have created them, along with the created dates/times: You can change this title at any time.

- 1 Press the DISC NAVIGATION button.
- 2 Press the MENU button.
- 3 Choose "Title" on the "PlayList" menu screen, and then press the ►/|| button.
- 4 Use the "Playlist Title" screen to select the play list whose title you wish to change, and then press the ►/|| button.

See "Changing Title of Program (Title)" on page 115 for how to enter a title.

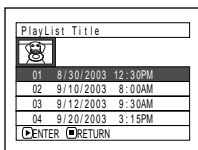

- 5 The screen for verifying exit will appear: Choose "YES" and then press the ►/|| button.

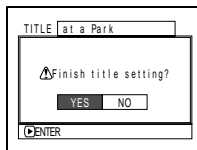

- 6 Press the □ button to quit.

After changing the title, the Disc Navigation screen on the play list whose title has been changed will appear.

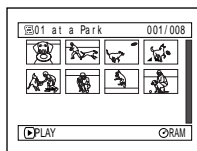

Note:

The registered title can be changed at any time using the same procedure.

DELETING PLAY LIST (DELETE)

- 1 Press the DISC NAVIGATION button.
- 2 Press the MENU button.
- 3 Choose "Delete" on the "PlayList" menu screen, and then press the ►/|| button.
- 4 Use the "Delete Playlist" screen to select the play list you wish to delete, and then press the ►/|| button.

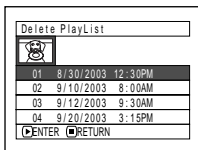

- 5 The screen for verifying deletion will appear: Choose "YES", and then press the ►/|| button.

Choose "NO" to cancel deletion. After Yes or No setting, the Disc Navigation screen of all programs will be restored.

Note:

Even if you delete a play list, the original scenes stored on disc will not be deleted.

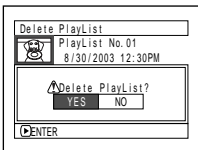

Go To

From the Disc Navigation screen, you can jump to the first scene or last scene.

TOP (END)

- 1 Press the DISC NAVIGATION button.
- 2 Press the MENU button.
- 3 Choose "Top" or "End" on the "Go To" menu screen, and then press the ►/II button.

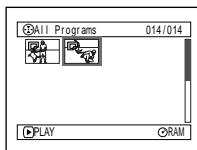
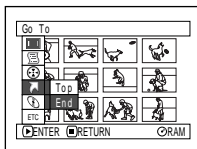

(When "End" is specified)

VERIFYING REMAINING FREE SPACE ON DISC OR CARD (CAPACITY)

You can find out how long you will be able to record on one side of disc or on card.

1 Press the DISC NAVIGATION button.

2 Press the MENU button.

3 Choose “Capacity” on the “Disc” or “Card” menu screen, and then press the **▶/||** button.

4 Press the **□** button to quit.

The Disc Navigation screen will be restored.

Note:

With a write-protected disc or locked card, the remaining space will always be displayed as “0”.

(When using disc)

(When using card)

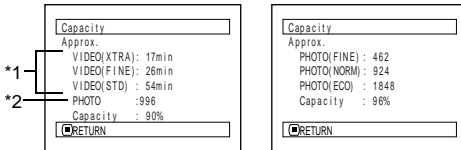

PROTECTING DISC FROM WRITING (PROTECT DISC)

You can protect a DVD-RAM disc in order to prevent recorded images from being erased or edited by mistake.

1 Press the DISC NAVIGATION button.

2 Press the MENU button.

3 Choose “Protect Disc” on the “Disc” menu screen, and then press the **▶/||** button.

Note:

- To release disc protection, perform the same procedure as above: The screen for verifying the release of protection will appear. Choose “YES” to release the protection.
- Further recording will not be possible on protected disc until the protection is released.

4 The screen for verifying protection will appear:

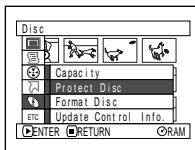

Choose “YES”, and then press the **▶/||** button.

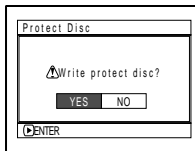

Choose “NO” to cancel protection. After “YES” or “NO” setting, the Disc Navigation screen will be restored.



Disc protect icon

INITIALIZING DVD-RAM DISC OR CARD (FORMAT DISC. FORMAT CARD)

If you want to erase all data on a recorded disc or card, you can initialize it rather than delete the data. Initialization is useful in this case, since it takes less time than deleting all data. The initialized disc or card can be used again.

- 1 Press the DISC NAVIGATION button.
- 2 Press the MENU button.
- 3 Choose "Format Disc" or "Format Card" on the "Disc" or "Card" menu screen, and then press the ►/II button.

The screen for verifying "Format Disc" or "Format Card" will appear.

- 4 Choose "YES", and then press the ►/II button.

Choose "NO" to cancel initialization.

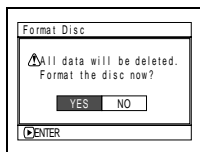

(When using DVD-RAM disc)

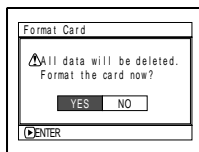

(When using card)

When initializing one side of the disc is complete, the DVD video camera/recorder will return to the recording pause status.

Note:

- Initialization will delete all the recorded contents on disc or card: Be careful not to delete data by mistake.
- Be sure to use the AC adapter/charger when initializing disc or card so that the DVD video camera/recorder is not turned off midway. If initialization is interrupted by power off, the disc or card will not be initialized correctly, or it may be damaged.
- It may not be possible to initialize a disc with many scratches or dirt: Such a disc cannot be used.
- If you use a brand-new DVD-R disc, message "Disc is not formatted" will appear: Initialize the disc, following the subsequent messages (See page 42).
- This DVD video camera/recorder may not recognize some discs or cards that have been initialized on PC or a device other than this DVD video camera/recorder.
- If you attempt to initialize a disc or card in this DVD video camera/recorder when it is connected to PC via PC connection cable, the disc or card may not be initialized and may be unusable on this DVD video camera/recorder.

UPDATING CONTROL INFORMATION OF DVD-RAM DISC

Disc Navigation in this DVD video camera/recorder handles information on scenes, such as skip, fade, in a particular manner. If you use another device to edit a disc recorded on this DVD video camera/recorder, and then use the data again with Disc Navigation in this DVD video camera/recorder, the Disc Navigation may not appear normally. If this happens, use the Update Control Info function to update the data.

1 Press the DISC NAVIGATION button.

2 Press the MENU button.

3 Choose “Update Control Info.” on the “Disc” menu screen, and then press the ►/|| button.

The screen for verifying “Update Control Info.” will appear.

4 Choose “YES”, and then press the ►/|| button.

The message for proceeding will appear, and then the Disc Navigation menu screen will be restored.

A black screen may appear while the message for updating is displayed.

Choose “NO” to cancel updating.

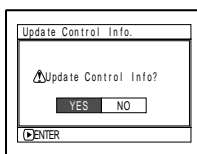

5 Press the □ button to quit.

Note:

- Be sure to use the AC adapter/charger when updating the control information so that the DVD video camera/recorder is not turned off midway. If updating of control information is interrupted by power off, the control information will not be updated correctly.
- It may take time to update the control information if the disc has many recorded scenes.
- Pressing the □ button on the screen for verification will restore the thumbnail display screen.

FINALIZING DVD-R DISC

If you want to play back a DVD-R disc recorded on this DVD video camera/recorder, using a device conforming to 8 cm DVD-R disc - such as a DVD player, etc. - you must finalize the disc on this DVD video camera/recorder.

The finalized DVD-R disc can be played on a DVD player, as "DVD Video": The date of program will appear on the menu screen of DVD player as a title.

1 Press the DISC NAVIGATION button.

2 Press the MENU button.

3 Choose "Finalize Disc" on the "Disc" menu screen, and then press the ►/II button.

The disc will be finalized.

4 Choose "YES", and then press the ►/II button.

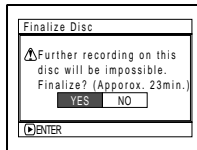

The message showing that the disc is being finalized will appear, and the disc will then be finalized.

© will appear on the Disc Navigation screen for a finalized disc.

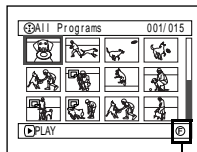

Finalized DVD-R disc

5 When finalization is complete, the Disc Navigation screen of all programs will appear.

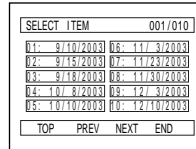

(Screen when viewed on DVD player)

Note:

- Do not finalize a disc recorded on this DVD video camera/recorder using any other device.
- No recording can be done on any DVD-R disc that has been finalized.
- If the disc in the DVD video camera/recorder has already been finalized, you cannot choose "Finalize Disc".
- Be sure to use the AC adapter/charger when finalizing disc. Finalization cannot be executed using a battery. If finalization is interrupted by power off, the disc will not be finalized correctly, or it may be damaged.
- The time required to finalize disc that appears on the "Finalize Disc" screen is only for reference.
- The shorter the recording time on disc, the longer it will take to finalize it.

Others

DISPLAYING MOVIES OR STILLS INDEPENDENTLY (CATEGORY)

Scenes recorded on this DVD video camera/recorder will be displayed in the order of recording regardless of whether they are movies or stills. You can use the Disc Navigation screen to switch this display to stills only or movies only.

- 1 Press the DISC NAVIGATION button.
- 2 Press the MENU button.
- 3 Choose "Category" on the "Others" menu screen, and then press the ►/II button.

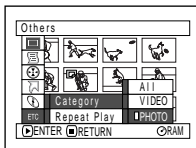

- 4 Specify the desired option for display, and then press the ►/II button.

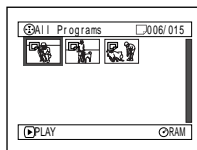

(When "PHOTO" is specified)

- All: To display all scenes, movies or stills, in the order of recording.
 VIDEO: To display only movies in the order of recording.
 PHOTO: To display only photos in the order of recording.

RAM R

PLAYING BACK SCENES REPEATEDLY (REPEAT PLAY)

- 1 Press the DISC NAVIGATION button.
- 2 Press the MENU button.
- 3 Choose "Repeat Play" on the "Others" menu screen, and then press the ►/II button.
- 4 Choose "On", and then press the ►/II button: Playback will start.

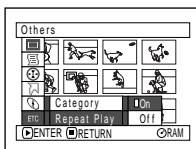

Choose "Off" to cancel Repeat Play Setting.

● When Repeat Play is set:

If one scene has been specified: When playback of the last scene is finished, playback of all scenes will repeat from the first scene.

If the range for playback has been specified: Playback of the scenes in that range will repeat.

● To release Repeat Play

Use one of the following 3 methods to release:

- Choose "Off" in step 4 above.
- Turn the DVD video camera/recorder off once.
- Press the DISC EJECT button to remove the disc.

Note:

- Press the □ button to terminate playback. However, the Repeat Play setting will not be cancelled.
- Still images can also be played back repeatedly.
- Repeat playback will not function when playback is instructed from the recording pause status.

SLIDE SHOW (CONTINUOUS PLAYBACK OF STILLS)

If you play back stills recorded on a card, the DVD video camera/recorder will enter the playback pause status after each still is played back.

Setting Slide Show allows you to continuously play back stills.

1 Press the DISC NAVIGATION button.

2 Press the MENU button.

3 Choose “Slide Show”, “All” or “DPOF”, and then press the ►/|| button.

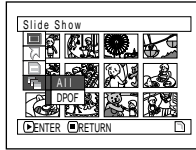

Note:

- One still is played for approx. 5 seconds.
- With slide show, playback starts from the first still on card.
- If you press the □ button or turn the DVD video camera/recorder off, Slide Show will be canceled.

All: To play all stills recorded on card in slide show.

DPOF: To play only stills to which DPOF has been set in slide show.

Pressing the ►/|| button will start slide show. When playback is finished, the DVD video camera/recorder will enter the playback pause status at the final still.

Pressing the □ button will restore the Disc Navigation screen.

Installing Software

Before installing the UDF driver (DVD-RAM driver) on the CD-ROM provided with this DVD video camera/recorder, make sure that another UDF driver* has not already been installed in your PC.

* InstantWrite[®] or InstantRead[®] packed in the “DZ-WINPC1W”, “DZ-WINPC2W” or PC connection kit for Hitachi DZ-MV100A DVD video camera/recorder, or in the “DZ-WINPC3W” PC editing kit for Hitachi DZ-MV200A, DZ-MV230A or DZ-MV270A DVD video camera/recorder.

If another UDF driver has already been installed, uninstall it, and then install the UDF driver bundled on the provided CD-ROM. Uninstall the previous UDF driver by choosing “Add/Remove Programs” or “Add/Remove Applications” on Windows[®] Control Panel.

If any question messages appear that mean “This file is not used on another application. Do you wish to delete it together?” during uninstalling, click “No” for all such questions.

Contents on Provided CD-ROM

The CD-ROM supplied with the DVD video camera/recorder contains the following folders:

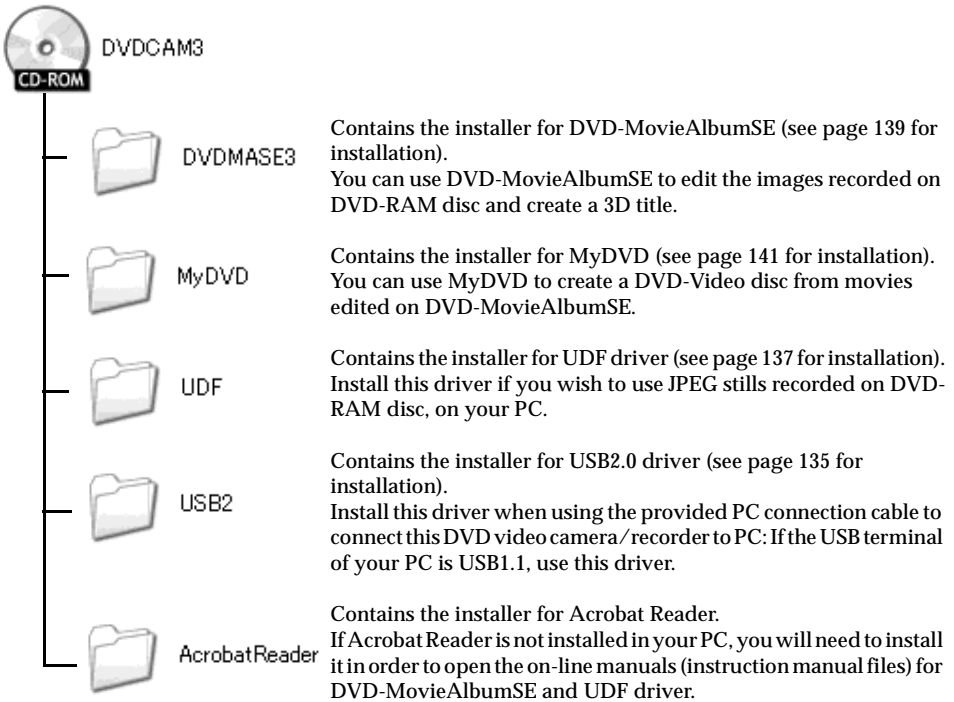

Although the CD-ROM may contain a folder or file other than the above, they will not be needed on this DVD video camera/recorder unless some special instruction is given.

● DVD-MovieAlbumSE

You can read the instruction manual using either of the following procedures:

- Open the PDF file in
DVIDMASE 3\manuals\English folder
contained on the provided CD-ROM.
- After installing DVD-MovieAlbumSE, open
“Programs” or “All Programs” from the
Windows “Start” menu, choose “Hitachi
DVDCAM” and “DVD-MovieAlbumSE”, and
then open “On-line Manual”.

To read the above manual, you will need Adobe Acrobat Reader.

If Adobe Acrobat Reader has not been installed in your PC, start AcrobatReader\English\AR500ENU.exe on the provided CD-ROM to install it.

● MyDVD

- After installing MyDVD, open “Programs” or
“All Programs” from the Windows “Start” menu,
choose “Sonic” and “MyDVD”, and then open
the electronic instruction manual in “Document”
folder.

To read the above manual, a Web browser (Internet Explorer, Netscape Communicator, etc.) must be set up in your PC.

If you cannot open the electronic instruction manual of MyDVD, consult the maker of your PC about the setup method for Web browser.

● UDF driver (DVD-RAM driver)

- After installing the UDF driver (DVD-RAM
driver), open “Programs” or “All Programs”
from the Windows “Start” menu, choose “DVD-
RAM” and “DVD-RAM Driver”, and then open
“How to use DVD-RAM disc”.

No electronic instruction manual is provided with the USB driver.

Note:

Although the above software programs can be used on Windows® 98, Windows® 98 Second Edition or later is needed to fully utilize all functions of DVD-MovieAlbumSE.

INSTALLING USB DRIVER

Use the following procedure to install the USB driver:

- 1 If you add a USB card (PCI card, PC card, etc.) on your PC, do it following the instruction manual for USB card, before connecting the DVD video camera/recorder to PC.
- 2 Insert the provided CD-ROM into PC, set the power switch of DVD video camera/recorder to “VIDEO”, and then use the provided PC connection cable to connect the DVD video camera/recorder to the USB terminal of PC.
- 3 The Hardware Wizard will start: Choose “Install from a list or specific location (Advanced)”, and then click “Next” (a figure will appear when Windows® XP is used).
- 4 Choose “Search for best driver in these locations”, check “Include this location in the search:”, and then specify the folder to be browsed:



Confirm

Click

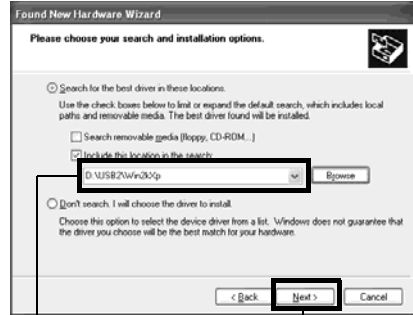

Confirm

Click

With Windows® XP / 2000 Professional:

D:\USB2\Win2kXp

With Windows® Me:

D:\USB2\WinMe

With Windows® 98 Second Edition:

D:\USB2\Win98

(D: shows the name of drive into which the CD-ROM is inserted.)

5 With Windows® XP, the message concerning Windows Logo Test will appear: Click “Continue Anyway”.



Click

6 Click “Finish”.



Click

INSTALLING UDF DRIVER (DVD-RAM DRIVER)

The following explanation uses the screens for Windows® XP: Use the same procedure for Windows® 98 Second Edition / Me / 2000 Professional to install the UDF driver.

- 1 Open the UDF folder on the provided CD-ROM and click “setup” or “setup.exe” to start it.
- 2 The driver setup screen will appear: Click the “Driver and Formatter Setup” button.
- 4 Check the contents of License Agreement: If you accept it, click “Yes”. (The contents displayed on actual screen may differ from those in the figure.)

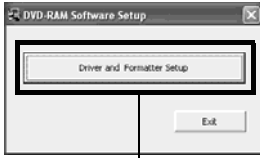

Click

- 3 Click “Next”.



Click



Click

- 5 Check the folder in which the UDF driver will be installed, and then click “Next”.

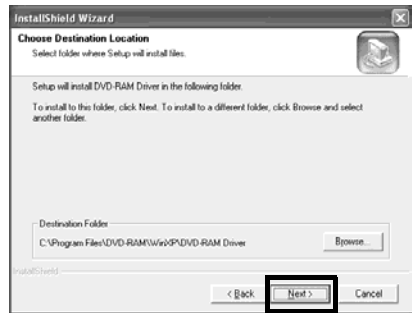

Click

- 6 Check the program folder to be installed, and then click "Next".

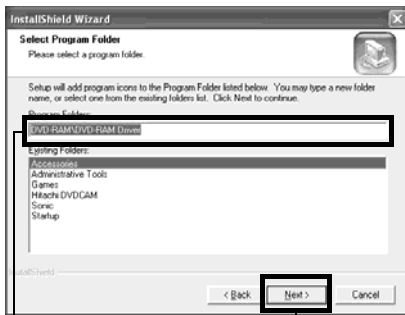

Confirm

Click

- 7 Click "Next".



Click

- 8 Installation will start. When installation is complete, some notes will appear: Check the contents, and then click "x" at the top right of window.

The contents displayed on actual screen may differ from those in the figure.

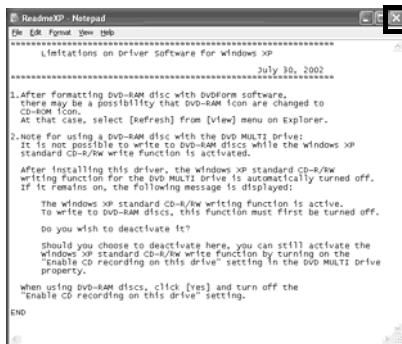

Click

- 9 If your PC uses Windows® XP / 98 Second Edition / Me, a message that prompts you to restart will appear: Click "Finish" and then restart the PC.

Installing the UDF driver is now complete. If your PC uses Windows® 2000 Professional, proceed with step 10.

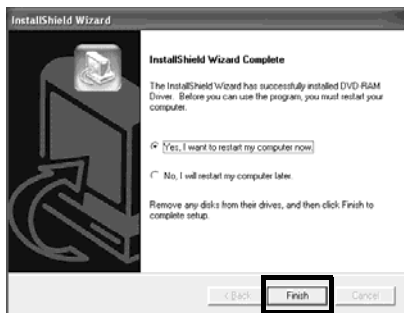

Click

- 10 If your PC uses Windows® 2000 Professional, a message announcing the start for detecting device will appear: Click “Finish”. The detection of device will start, after which it will take several minutes for PC to detect the device. When detecting the device is complete, a message that prompts you to restart will appear: Click “Yes” and then restart the PC.

Installing the UDF driver is now complete.

INSTALLING DVD-MovieAlbumSE

Software “DVD-MovieAlbumSE” is used to edit movies that conform to DVD video recording standard, and stills recorded on DVD-RAM disc.

- 1 Insert the provided CD-ROM into the CD-ROM drive of PC.
- 2 Use Windows My Computer or Explorer to open the folder where CD-ROM is stored.
- 3 Open the DVDMASE3 folder, and then double-click “Setup” or “Setup.exe”.
- 4 The screen for installing “DVD-MovieAlbumSE” will appear: Click “Next”.

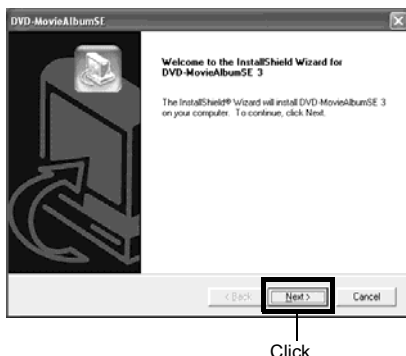

- 5 Carefully read the Software License Agreement: If you accept it, click “Yes”.

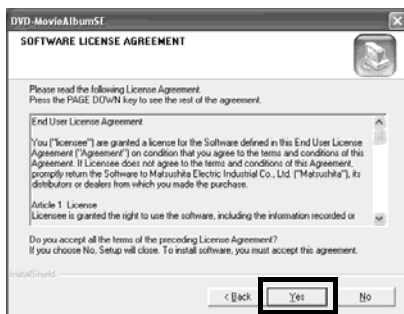

- 6 Choose the TV broadcast system (NTSC or PAL), click “Next”.

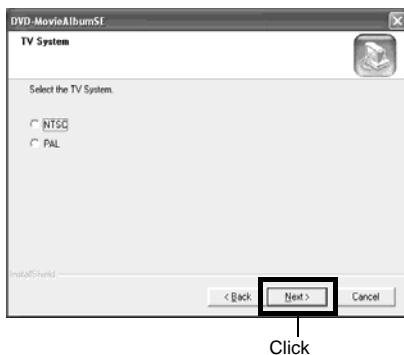

7 If you do not change the folder where the software is installed, click “Next”.

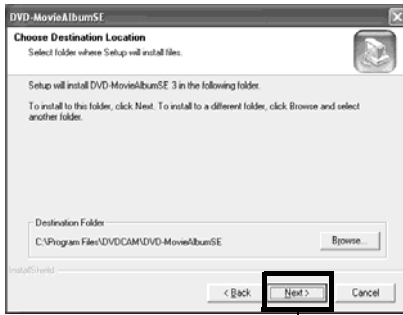

Click

8 If you do not change the program folder name, click “Next”.



Click

9 Check the contents, and then click “Next”.

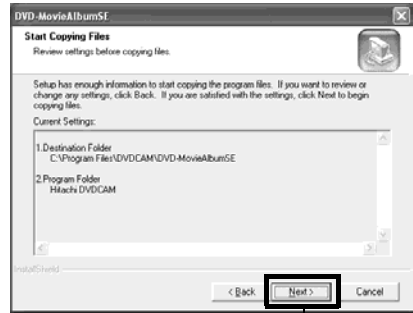

Click

Installation will start.
Proceed with installation, following the instructions on screen.

10 A message for verifying whether a shortcut icon is to be created on desktop will appear:

If you want to create one, click “Yes”. If not, choose “No”.

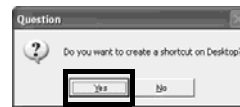

Click

11 Choose the restart option, and then click “Finish”.

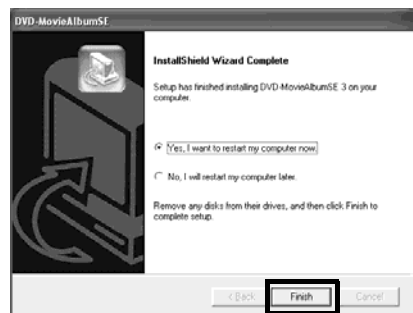

Click

INSTALLING MyDVD

- 1 Insert the provided CD-ROM into the CD-ROM drive of PC.
- 2 Use Windows My Computer or Explorer to open the folder where CD-ROM is stored.
- 3 Open the MyDVD folder, and then double-click "Setup.exe".
- 4 The screen for installing "MyDVD" will appear: Click "Next".

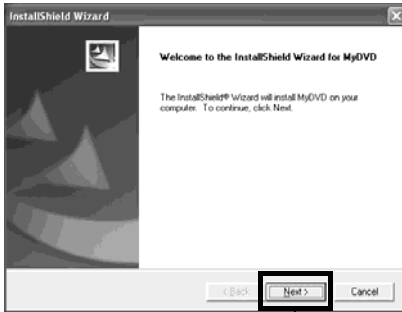

- 5 Carefully read the Software License Agreement: If you accept it, click "Yes".



(This window may be omitted.)

Click

- 6 If you do not wish to change the folder where the software is installed, click "Next".

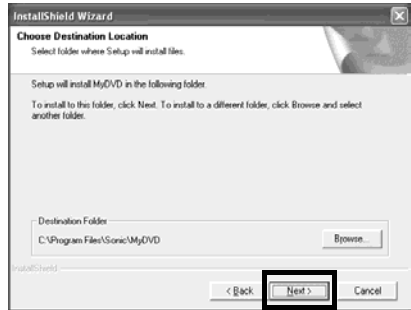

Click

7 Check the contents, and then click “Next”.

Installation will start.

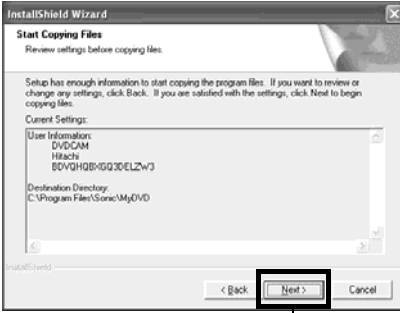

Click

8 Click “Finish”, and then restart the PC.

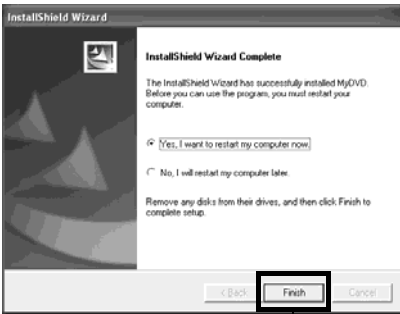

Click

Sonic Solutions Corporation, which developed MyDVD, recommends user registration of MyDVD, in order to offer appropriate support to customer. The guide for user registration will appear when you start MyDVD for the first time, or you can do it any time by accessing the following URL:

<http://www.mydvd.com>

(You will need the connection environment to the Internet for user registration.)

Note:

- If software that detects computer virus, etc. has been installed, invalidate it.
- If your PC uses Windows® XP or Windows® 2000 Professional, set the user name to “Administrator (computer’s manager)” (or user name with equivalent authorization), log on to PC, and then install the software (if you do not have authorization, consult your system manager.).

Contact the following for information on MyDVD:

U.S.

Phone: 1-877-383-1124

<http://support.sonic.com/login/default.asp>

(You will need to perform customer registration.)

Europe (London)

Phone: 44-20-7437-1100

<http://support.sonic.com/login/default.asp>

(You will need to perform customer registration.)

Creating DVD Video on PC from DVD-RAM Disc Recorded on DVD Video Camera/Recorder

Using DVD-MovieAlbumSE and MyDVD, you can create a DVD video (DVD-R disc) from the images recorded on this DVD video camera/recorder, following the procedure below:

- 1 Insert a recorded DVD-RAM disc into the DVD video camera/recorder, and connect the DVD video camera/recorder to the USB terminal of PC.
- 2 Start DVD-MovieAlbumSE, and edit the images on DVD-RAM disc as necessary.
- 3 Right-click the thumbnail from which you wish to create a DVD video on the DVD-MovieAlbumSE screen, and execute "Export".
- 4 The "Program Export" screen, shown below, will appear: Choose "Same Resolution" and check "Use DVD-Video" in the "Export Mode" setting box. Choose "704 × 480 (recommended)" for "Resolution".



"Program Export" Screen

Note:

- Choose "Divide by Marker" in the "Option" box: Each scene of program recorded on the DVD video camera/recorder will be saved as an independent movie file so that export can be executed at high speed. If you do not choose "Divide by Marker", movie files may be unified and re-encoded, so it may take time to export them or the image quality may slightly deteriorate. DVD-MovieAlbumSE may automatically encode a movie recorded in the XTRA mode containing rapidly moving scenes (8 Mbps or higher), regardless of the "Divide by Marker" setting.
- Do not choose "Simple Export" in the "Export Mode" setting box: Choosing it may stop export midway.

- 5 Click the Start button to start export.
- 6 When export is complete, message "The file exporting was completed successfully. Do you wish to create a 'DVD-Video' disc or an 'MPEG file' disc?" will appear. Check the small box for "Eject the disc being used", and then click "Yes".

Insert a brand-new DVD-R disc into the DVD video camera/recorder.

- 7 DVD-MovieAlbumSE will automatically end, and the "Export to Disc" screen will appear: Click the "Start" button.

8 MyDVD will automatically start. After a few moments, the exported scene will be automatically registered on the MyDVD editing screen:

Now you can change the DVD menu to the desired style, change the title, etc. on this editing screen.



9 Click the Burn button: Writing to DVD-R disc will start. When writing is complete, a DVD video disc will be created. Then the disc cover of DVD video camera/recorder will open automatically.

Note:

- The menu screen created on MyDVD will not appear on the DVD video camera/recorder. Also, depending on the written contents, the images may not be playable on the DVD video camera/recorder. In such cases, use a standard DVD player to display the created menu.
- The following table shows the recordable time on 8 cm DVD-R disc from MyDVD. The recordable time is shorter than that of 8 cm DVD-RAM disc because MyDVD always records audio in the LPCM format.

Movie quality mode of DVD-RAM disc in DVD video camera/recorder	Recordable time on 8 cm DVD-R disc (using MyDVD)
STD	Approx. 40 minutes
FINE	Approx. 25 minutes
XTRA	At least 18 minutes

* If "Style" created on MyDVD is a movie or there are many thumbnails, the recordable time will be less than that shown in the above table.

The following discs created on MyDVD cannot be played back on this DVD video camera/recorder:

- Discs containing slide show (*1)
- Discs with no audio
- Discs with audio longer or shorter than video

*1 Cannot be created on MyDVD depending on the version.

Cleaning

Be sure to set the power switch to "POWER OFF" before cleaning this DVD video camera/recorder.

● **Cleaning LCD screen and camera lens**

Use dry, soft cloth to wipe dirt off. When cleaning the LCD screen, be careful not to use force, scratch it, or subject it to impact: Doing such could cause a defect in the screen, result in display unevenness, or damage the LCD monitor.

● **If dust adheres to the viewfinder lens, remove it using a cotton swab, etc.**

Do not rub the lens with force: Doing so could scratch the lens.

● **Do not use benzene or thinner to clean DVD video camera/recorder case**

The coating of case could peel off or the case could deteriorate. Wipe off dirt on the case with a moist cloth which has been completely wrung out. When using chemical cleaning cloth, follow instructions for use.

Changing Setting of Demonstration

This DVD video camera/recorder has versatile functions, including special effects.

Referring to the procedure on page 40, connect the DVD video camera/recorder, AC adapter/charger and power cable to power the DVD video camera/recorder from AC outlet.

1 Press the MENU button.

2 Choose “Initial Setup”, “Demo Mode”, and then press the ►/II button.

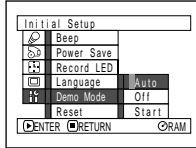

3 Use the joystick to choose the desired option, and then press the ►/II button.

Auto: To start demonstration approx. 3 minutes after turning the DVD video camera/recorder on.

Off: To set demonstration to off.

Start: To start demonstration immediately.

Press the MENU button again: The menu screen will disappear.

To stop the demonstration midway, press the □ button.

The demo mode will end when the DVD video camera/recorder is turned off or the DISC EJECT button is pressed down.

Note:

- You can press the DISC NAVIGATION button to stop demonstration midway: The Disc Navigation screen will appear.
- If you choose “Auto”, the demonstration will not start if a disc is loaded with the power switch set to “VIDEO” or “PHOTO”, or a card is loaded with the power switch set to “CARD PHOTO”.
- The demonstration function will not work when the DVD video camera/recorder is connected to PC.
- While the demonstration is being given, the recording indicator will blink.



No DVD Video Camera/Recorder Operation - Check the Following:

Check 1	No movie can be recorded
<p>Movie can be recorded only on DVD-RAM or DVD-R disc.</p> <p>Check the following:</p> <ul style="list-style-type: none"> • Is DVD-RAM or DVD-R disc inserted? • Is power switch set to "VIDEO"? • Is the DVD-RAM disc in DVD video camera/recorder write-protected? Release the write-protect. • Does disc have remaining recording space? <p>If movie still cannot be recorded after the above check is clear, the disc may be damaged: Use another disc.</p>	

Check 2	No still can be recorded
<p>Still can be recorded only on DVD-RAM disc, SD memory card or multimedia card.</p> <p>Check the following:</p> <ul style="list-style-type: none"> • Is DVD-RAM disc, SD memory card or multimedia card inserted? • Is power switch set to match the recording medium? <ul style="list-style-type: none"> – When using DVD-RAM disc: Set to "PHOTO". – When using SD memory or multimedia card: Set to "CARD PHOTO". • Is loaded DVD-RAM disc write-protected? • When using SD memory card: Is it locked? • Does disc or card have remaining recording space? <p>If still cannot be recorded after the above check is clear, the disc or card may be damaged: Use another disc or card.</p>	

Check 3	Skip or search playback does not work well
<p>If the temperature inside the DVD video camera/recorder is high, normal operation may not be possible. Turn the DVD video camera/recorder off, wait for a few moments, and then turn it on again for operation.</p>	

Check 4	No operation can be performed because the ACCESS/PC or CARD ACCESS indicator on this DVD video camera/recorder remains lit or blinking. After disc or card is inserted, it takes some time until recording is possible.
<p>In the following cases, it will take more time than usual until operation is possible:</p> <ul style="list-style-type: none"> • When disc or card is removed and then reinserted • When date changes (e.g., during the first recording of the day) • When the temperature is greatly different from the status of previous recording • When disc with scratches, dirt or fingerprints is inserted • When disc is subject to severe vibrations • When the battery or DC power cord was disconnected instead of following the correct procedure using power switch to turn the DVD video camera/recorder off 	

Check 5	No DVD video camera/recorder operation
<p>Is a fully charged battery attached? Is the DVD video camera/recorder powered from AC outlet?</p>	

Check 6	No image in viewfinder
<p>Is LCD monitor open? No image will appear in viewfinder unless the LCD monitor is closed and securely locked to DVD video camera/recorder.</p>	

Check 7	No image appears on the LCD screen or in the viewfinder
<ul style="list-style-type: none"> • Is DVD video camera/recorder connected to PC using PC connection cable? Unplug the PC connection cable. • Does DVD video camera/recorder stop at the end of the scene to which wipe-out was set and played back? Press the DISC NAVIGATION button. 	

Trouble Messages

A message may appear while you are operating the DVD video camera/recorder. If a message appears, refer to the following table and take appropriate corrective action. Messages on page 150 and later are arranged in alphabetical order.

Message	Cause & Troubleshooting	Reference page
<p>(1) Data error in a part of image file. Repair data now?</p> <p>(2) Found error in image file. Repair data now?</p> <p>(3) Data error in all image file. Repair all data now?</p>	<p>It is possible that the system cannot normally complete writing of file when power is turned off for some reason during recording or editing (deleting, dividing or combining scenes, or creating play list). Selecting "YES" will automatically repair the video file, but even if "NO" is selected, the same message will appear when the DVD video camera/recorder is turned on next time. (Do not remove the disc while the DVD video camera/recorder is recognizing it: Ignoring this will deactivate the file repair function.)</p> <p>Follow the instructions on screen, taking note of the following cautions:</p> <ul style="list-style-type: none"> • Data may not be repaired, depending on the timing when power was turned off. • Data may not be repaired normally if data recorded on another recorder is mixed in. • The repaired data may be different from the original recorded content because of partial deletion of defective portion. • Since the date/time for repair is added to the repaired data (only the corrected portion for partial repair), the original date/time information will be lost. • Since all movies, and then all stills, are repaired, the order of recorded contents will be lost. <p>(In case of message (2) (3) only)</p> <ul style="list-style-type: none"> • See *1 on page 155 	—
<p>(1) Disc is not formatted. If it formats, it becomes possible to use for camera.</p> <p>(2) However, when you record from PC connection terminal, please do not format.</p> <p>(3) Format the disc now?</p>	DVD-R disc that was not initialized for camera use was inserted.	42
<p>(1) Error has occurred. Please restart.</p> <p>(2) Error has occurred. Please reinsert a disc.</p> <p>(3) Error has occurred. Error code No. xxxx. Please read the manual.</p> <p>(4) ERROR xxxx</p>	<ul style="list-style-type: none"> • Error has occurred. Try to restart the DVD video camera/recorder using the following methods: <ul style="list-style-type: none"> (1) Turn power off, remove the battery or AC adapter/charger and reattach it, and then turn power on again. (2) Turn power off, and reinsert the disc. Then turn power on again. (3) Take note of the number (xxxx), and then consult your dealer. • See *3 on page 155. 	8, 37, 40, 41
Battery is almost empty. Replace it.	Replace with a charged battery, or use AC adapter/charger to power the DVD video camera/recorder.	36, 40
Cannot combine scene.	Unless consecutive scenes are selected, they cannot be combined.	107

Message	Cause & Troubleshooting	Reference page
Cannot combine. Deselect PHOTO scenes.	Select only movies and combine them.	107
Cannot combine. Select multiple scenes.	Select a range of at least 2 scenes to be combined, and then combine them.	107
Cannot delete scenes.	This may occur when scene that was edited for division, etc. is to be deleted. Combine the divided scenes, and then delete them.	107
Cannot execute. Change display category to ALL.	This message will appear if you attempt to combine or move scenes with "Category: VIDEO or PHOTO" specified.	130
Cannot execute. Unselect multiple scenes.	Division or change in thumbnail was executed when multiple scenes were selected.	98
Cannot move scene in program mode. Create new PlayList.	Scenes can be moved only on a play list. Create a play list and move the scenes on it.	123
CANNOT RECORD PHOTOS	Are you using DVD-R disc? You cannot record still image on DVD-R disc (recordable of still images from PC). Use DVD-RAM disc to record still images.	22
Cannot replace thumbnail on PHOTO scene.	The thumbnail of a still cannot be changed. Select a movie.	103
Cannot select any more scenes.	The maximum number of selectable scenes is 999.	112
CARD ALMOST FULL	Remaining space is only enough to record less than 10 stills. Delete unnecessary stills and try the card, or use another card.	27, 101
Card error has occurred. Format the card now?	Was the card formatted on PC? Was formatting interrupted midway? When using the card on this DVD video camera/recorder, choose "YES" and format it.	127
Card error has occurred. Formatting is not complete.	The card may be damaged: Use another card.	25
Card error.	<ul style="list-style-type: none"> The card terminals may be dirty: Wipe off dirt, and try the card again, or use another card. Data other than still image may be included: Use another card. 	25
Card error has occurred. Keep card inside & restart.	Card error could have occurred during editing of scenes. Turn off the DVD video camera/recorder with the card being used inside, connect the AC adapter/charger, and then power the DVD video camera/recorder again. Repair of scenes will be attempted.	40, 45
Card full.	Delete unnecessary stills and try the card, or use another card.	27, 101
	No more recording on this card can be done: Delete unnecessary stills or use another card.	
Card full. Cannot execute.	Delete unnecessary stills and try the card, or use another card.	27, 101

Message	Cause & Troubleshooting	Reference page
Card has no data.	This message will appear when the ►/ button is pressed with a card inserted on which no still is recorded. (It will appear if you attempt playback or editing on Disc Navigation, but will not appear if you press ►/ on camera through image.)	—
Card is not formatted. Format the card now?	Was the card formatted on PC? When using the card on this DVD video camera/recorder, choose "YES" and format it.	127
Control Information Error.	Mismatch may occur between the recorded image and scene information. Update the control information.	128
	<ul style="list-style-type: none"> • Use another disc. • See *3 on page 155. 	22, 76
COPY PROTECTED	The video signal input to this DVD video camera/recorder may be copy-guarded. Some prerecorded video materials, such as movies, are guarded against copying. Copy-guarded materials cannot be recorded on this DVD video camera/recorder.	66
DISC ACCESS	The recorded scene is being stored on disc. Wait until the message disappears, and you can start to use the DVD video camera/recorder.	50, 53
	This DVD video camera/recorder is verifying whether the correct disc has been inserted. Wait until the message disappears, and you can start to use the DVD video camera/recorder. This message will be displayed for a little longer when the date changes.	—
DISC ALMOST FULL	The disc will soon be full, and recording will be impossible. Delete unnecessary scenes and try the disc again, or use another disc.	26, 27, 101
Disc error has occurred. Finalizing is not complete.	<ul style="list-style-type: none"> • Disc error occurred during finalizing, and finalizing failed. Replace the disc. • See *3 on 155 	129
Disc error has occurred. Format the disc now?	<ul style="list-style-type: none"> • Has the disc been initialized on PC? Has initializing the disc on PC been interrupted? Choose "YES" and initialize the disc when using it on this DVD video camera/recorder. Initializing the disc will erase all data on it. • See *2 on page 155. 	127
Disc error has occurred. Formatting is not complete.	The disc may be dirty. Remove the disc and wipe off fingerprints, dust, etc. before reusing it, or use another disc. This message may also appear if you insert a disc for which formatting was interrupted midway. In this case, use another disc.	76, 127
Disc error has occurred. Keep disc inside & restart.	Disc error could have occurred during editing of scenes. Turn off the DVD video camera/recorder with the disc being used in it, connect AC adapter/charger, and then power the DVD video camera/recorder again. Repair of scenes will be tried.	40

Message	Cause & Troubleshooting	Reference page
Disc error.	<ul style="list-style-type: none"> • Use another disc. • See *3 on page 155. 	22, 76
	<ul style="list-style-type: none"> • Mismatch in recording information may be caused by editing done on some device other than this DVD video camera/recorder. Initialize the disc or use another disc. • Initializing the disc will erase all data on it. 	127
“DISC ERROR” appears when an attempt to release write-protect is made.	If you have write-protected a disc using the write-protect setting tool (WPTOOL) that is equipped with the UDF driver contained on the CD-ROM provided with this DVD video camera/recorder, you cannot release the write-protect on this DVD video camera/recorder as is. Use the write-protect setting tool on PC to release the write-protect.	—
Disc full. Cannot execute.	Delete unnecessary scenes before using this disc, or use another disc.	101
Disc has no data.	This message will appear when the ►/ button is pressed with a disc inserted on which no still is recorded (It will appear if you attempt playback or editing on Disc Navigation, but will not appear if you press ►/ on camera through image.).	—
Disc has no Play List.	Switching of play list was selected with no play list stored.	118
Disc includes protected scenes. Delete scenes?	The disc may be software protected from a device other than this DVD video camera/recorder. To release this case, use a device that has executed software-protect.	—
Disc is full. Cannot add control info.	The number of entered scenes has reached the limit that can be entered, so the control information for generating thumbnails cannot be added. Combine several scenes or delete them.	101, 107
Disc is not formatted. Format the disc now?	<ul style="list-style-type: none"> • Has the disc been initialized on a PC? Choose “YES” and initialize the disc when using it on this DVD video camera/recorder. Initialization will delete all data on the disc. • See *2 on page 155 	127
DPOF is not set to a scene.	This message will appear when “Slide Show: DPOF” is specified for the card to which DPOF was not set.	131
DPOF scenes over limit. Cannot set DPOF scenes.	The maximum number of scenes for which DPOF can be set is 999.	111
Drive overheat. Please retry later.	The temperature inside the DVD video camera/recorder is too high, and reading or writing of the data on disc may not be performed normally. Turn the DVD video camera/recorder off and wait for a while. The temperature will be effectively decreased if the DVD video camera/recorder is placed in a well-ventilated spot.	45
DVD-R Disc, Video mode cannot be changed.	With DVD-R disc, the movie quality mode once used for recording cannot be changed.	26
END OF DISC	The disc is full. You cannot record on this disc anymore. Prepare another disc or delete unnecessary movie scenes from this disc.	26
End scene cannot be divided.	Division is not possible at the end of scene.	108

Message	Cause & Troubleshooting	Reference page
Error occurred. Please replace disc or format disc.	<ul style="list-style-type: none"> Abnormality has occurred with the DVD-RAM disc to be repaired. Initialize the disc before using it, or use the another disc. Initializing the disc will erase all data on it. See *2 on page 155. 	127
Error occurred. Please replace disc.	Use another disc.	—
Finalize may not be complete. Finalize again now?	Instantaneous shutoff occurred during finalizing, after which power was supplied and disc was inserted.	129
It is unrecordable on this card.	The inserted card cannot be used in this DVD video camera/recorder: Use another card.	25
JPEG file related to scenes are not found.	This message will appear when stills recorded on DVD-RAM disc using a device other than this DVD video camera/recorder are to be copied to card.	—
No card.	Insert a card.	44
No card. Please insert card.	No card is inserted. Insert a card.	44
NO DISC	This message may appear when the DVD video camera/recorder or disc is moved from a cold place to a warm place. Condensation has occurred on the camera/recorder lens or DVD-RAM drive. Do not remove the disc; leave the DVD video camera/recorder turned off in a place as dry as possible for 1-2 hours.	8
	The disc has not been inserted. Insert it.	41
No more scenes. Play List was deleted.	<ul style="list-style-type: none"> All scenes are deleted from the play list. Since a play list with no scenes cannot be supported by specifications, a play list from which all registered scenes have been deselected will be deleted. 	121, 122
Photo cannot be divided.	Still image cannot be divided.	108
PlayLists over limit.	An attempt was made to create new play list or copy play list, even though limit specified for play lists in the video recording standard had already been stored.	117
Same scenes on Play List will be deleted. Delete scenes?	<ul style="list-style-type: none"> This will appear when scenes are to be deleted. When a play list exists on disc, an attempt to delete scenes in program will display this message. (This message will not appear if you deselect scenes from play list.) 	101

Message	Cause & Troubleshooting	Reference page
Scene without control info. Update control information?	<ul style="list-style-type: none"> This message may appear when a disc edited on a device other than this DVD video camera/recorder is to be used. In this case, choose "YES" on the verification screen. This DVD video camera/recorder will make the disc playable and display the Disc Navigation screen normally. This message may appear when a disc is used on which scenes with different recording dates were combined on this DVD video camera/recorder. If you choose "YES", the combined scene will be divided and the Disc Navigation screen will appear normally. If you choose "NO", the combined scene will not be divided and the Disc Navigation screen will appear normally: In this case, however, this message will appear each time the DVD video camera/recorder is turned on. 	128
Scenes over limit. Cannot add scene.	The number of scenes entered in play list has reached the limit that can be entered. Delete several scenes.	117, 122
Scenes over limit. Cannot divide scene.	The number of entered scenes has reached the limit that can be entered. Delete several scenes.	108, 117
Scenes over limit. Cannot move scene.	This message will appear if you try to move a scene when the number of scenes has already reached the registrable limit.	106, 117
Stop processing	The button was pressed to stop processing of multiple scenes.	—
There was no scene which can be deleted.	This message will appear if you try to delete multiple scenes on Disc Navigation when all the selected scenes have been locked. Release the lock on scenes before executing deletion.	101, 110
This card cannot be used. Please replace card.	The card cannot be used in this DVD video camera/recorder: Use another card.	25
This disc cannot be used. Please replace disc.	A disc that cannot be used on this DVD video camera/recorder has been loaded. Check the type of disc.	23
This disc is recorded by the PAL system. Please replace disc.	This DVD video camera/recorder can use only discs recorded on the NTSC system. A disc recorded on the PAL system cannot be used on this DVD video camera/recorder.	—
Top scene cannot be divided.	Division is not possible at the start of scene.	108
UNFORMAT DISC	The disc is not initialized or it is damaged. If this message appears, be sure to initialize the disc on this DVD video camera/recorder before using it. Reinitializing even a disc used on this DVD video camera/recorder may be necessary (initializing will erase all recorded contents on disc). If this message appears, try to initialize the disc. If the same message still appears, the disc may be damaged: Use another disc.	127
	See *2 on page 155.	76
Use AC adapter/charger.	Finalization is not possible when the DVD video camera/recorder is powered by a battery: Use the AC adapter/charger for finalization.	40, 129

Message	Cause & Troubleshooting	Reference page
Use AC adapter/charger. Turn off power.	Scene cannot be repaired when the DVD video camera/recorder is powered by a battery. If the AC adapter/charger is unavailable in handy place, remove the disc, use the opposite side, or use another disc. To repair the removed disc, insert the disc into the DVD video camera/recorder afterwards, and connect the AC adapter/charger.	40
VIDEO scene cannot be copied to card.	No movie can be copied to card. Select stills and copy them to card.	109
Write protected. Check card.	<ul style="list-style-type: none"> • A locked card or write-protected disc is inserted. • Release the lock or write-protect using the Card or Disc Navigation menu. 	25, 126
Write protected. Check disk.		

*1

- This message may also appear when dirt adheres to disc. If this message appears when a recorded disc is recognized immediately after it is inserted, do not repair the disc; remove it and then use a soft, dry cloth to clean off the dirt before using it.
- This message may also appear when condensation occurs. In this case, do not repair the disc; turn the DVD video camera/recorder off, wait until it dries out, and then turn it on again.
- If the repair message appears when you turn the DVD video camera/recorder on from off with a disc loaded after recording on it, choose repair.
- If the repair message appears when recording and playback are normally possible with another disc - and no condensation occurs and the disc is not dirty - choose repair.

*2

- This message may also appear when dirt adheres to disc. In this case, do not initialize the disc; remove it and then use a soft, dry cloth to clean the dirt before using it.
- This message may also appear when condensation occurs. In this case, do not initialize the disc; turn the DVD video camera/recorder off, wait until it dries out, and then turn it on again.
- Initialization will delete all data on disc.

*3

- This message may also appear when dirt adheres to disc. Remove the disc and then use a soft, dry cloth to clean the dirt before using it.
- This message may also appear when condensation occurs. Wait until the DVD video camera/recorder dries out, and then turn it on again.

Troubleshooting

Check to see the following before asking for a repair. If the suggested solution still cannot restore the DVD video camera/recorder to normal, do not attempt to repair it yourself, but consult your dealer.

Power supplies

Symptom	Cause and Correction	Reference page
Battery cannot be charged.	Is the ambient temperature too low or too high? Charge the battery at 50-86°F (10-30°C).	36
	Is the battery abnormally hot? Remove the battery, leave it for a while to cool down, then charge it.	
	Is the DC power cord connected to AC adapter/charger? Unplug it.	
	Has the battery been unused for a long time? Remove the battery, and then reattach it. If the battery is still not charged, it may be dead: Purchase a new one. * If the battery does not charge after you try the above four procedures, it may be dead: Purchase a new battery.	
Battery weakens fast	Are you using the DVD video camera/recorder where the temperature is very low? The DVD video camera/recorder can normally be used for 40-60 minutes with a fully charged battery, but this time will be shorter at low temperatures. Keep extra batteries on hand.	38
	Battery may be dead. The performance of battery will deteriorate if it is used for an extended period of time or frequently: Purchase a new battery.	39
The CHARGE indicator on AC adapter/charger is blinking.	Is the ambient temperature too low or too high? Charge the battery in environment where the temperature is 50-86°F (10-30°). The battery has possibly discharged excessively. Continue charging: After a while, the battery will be charged to the specified voltage, and the CHARGE indicator will light. Then the battery charge will be completed normally.	36
Power turns off immediately after being turned on.	Is battery charged? Charge it.	36
When power is turned on, the LCD screen will turn on and off.		
Power goes off unexpectedly.	Is Power Save set to "On"? If the powered DVD video camera/recorder is left for as long as 5 minutes without recording or playback with "Power Save: On" specified, it will automatically turn off to save battery power. To restart recording in this case, set the power switch to "POWER OFF" and then set it to "VIDEO". You can also specify "Power Save: Off" to stop automatic power off.	92
Power cannot be turned off.	Detach the battery or AC adapter/charger once, and then press the RESET button of DVD video camera/recorder: Reattach a power supply to DVD video camera/recorder before turning it on again.	—

During recording

Symptom	Cause and Correction	Reference page
Pressing the REC button will not start recording.	Is input image copy-guarded? Copy-guarded image cannot be recorded on this DVD video camera/recorder.	66
Recording starts but stops immediately.	Is disc scratched or does dirt or fingerprint adhere to it? Clean the disc. If there is still no improvement, replace the disc.	76
	Is some other AV device directly connected to the video/audio input/output jack of this DVD video camera/recorder? If the AV device is connected via several other devices, such as AV selector, the video signal may not be transmitted incorrectly. In such a case, reduce the number of devices through which the video signal is transmitted, or connect AV device directly.	65
	Are you attempting to record image from video game or PC? From some video games or PCs, image cannot be recorded on this DVD video camera/recorder.	66
LCD screen is hard to see.	Has brightness of LCD screen been adjusted? Stop recording and adjust the brightness.	91
	Is the DVD video camera/recorder being used outdoors? Use the viewfinder. When using LCD monitor, adjust its angle so that LCD screen is not exposed to direct sunlight.	45, 47
Focus is not correct.	Is it difficult to use auto focus with your subject? Focus manually.	58
	Does "MF" appear? The DVD video camera/recorder is set to manual focus. Focus the subject manually, or release manual focus.	57
	Is the diopter control correctly adjusted if you are using the viewfinder as a monitor? Adjust the diopter control.	46
	In cases other than the above, set the power switch to "POWER OFF", and then set it to "📷 VIDEO", "📷 PHOTO" or "📷 PHOTO" again.	45

During playback

Symptom	Cause and Correction	Reference page
Recognition of disc is not complete	Is disc dirty? Use soft, dry cloth to clean it.	76
Pressing the playback button will not start playback.	Has the image been recorded by devices other than this DVD video camera/recorder? Playback of image recorded on devices other than this DVD video camera/recorder may be impossible on this DVD video camera/recorder. Has scene been edited on a device other than this DVD video camera/recorder? If a scene recorded on this DVD video camera/recorder is edited on a device other than this DVD video camera/recorder, playback may not be possible on this DVD video camera/recorder.	128
No playback picture appears on TV screen.	Is TV input selector set correctly? Some TVs have multiple video input jacks. Check whether the correct input was selected on TV to match the connected jacks. If the DVD video camera/recorder is connected to VCR, set its input selector to "external input (LINE)".	73
	Is the DVD video camera/recorder connected to TV correctly? Check the connections.	72
Playback picture is momentarily interrupted.	Is disc scratched or does dirt or fingerprint adhere to it? Clean the disc.	76
Poor playback picture	Was the image input from analog VCR (VHS, 8 mm) and recorded? The problem may be improved if a VCR equipped with TBC circuit is used for playback.	—
Playback picture is greatly distorted.	Was recording of external input made with "Frame" specified? Specify "Field" for "PHOTO Input" in record mode settings.	88
No sound	Is the TV volume control set correctly? Adjust TV volume control, and be sure to adjust the volume on TV.	73
Disc Navigation thumbnails do not appear.	Was the image recorded from AV input/output jack with interference? Record image with no noise or disturbance.	—

When the DVD video camera/recorder is connected to PC:

Symptom	Cause and Correction	Reference page
No drive icon appears on PC.	The DVD video camera/recorder is not turned on. Check the power supply.	45
	Driver is not properly recognized. Turn PC off and on again. If the drive icon still does not appear, use "Refresh driver" in Device Manager to reinstall the driver.	—
	Turn PC off and then disconnect the PC connection cable. Turn PC on again, and then use the PC connection cable to connect the DVD video camera/recorder to PC.	—
	Make sure the PC connection cable is completely plugged into this DVD video camera/recorder.	—
	If a yellow "!" mark is attached to some device in Windows® Device Manager, uninstall the USB device driver, and then reinstall it, following the procedure on page 135.	—
A fatal exception 0A error occurs while installing USB driver in Windows® 2000 Professional.	It is recommended that you install Windows® 2000 Service Pack 3 or later.	—
Error occurs in playback of DVD video camera/recorder on PC.	If error occurs with USB connection, the transfer rate is not sufficient. It is recommended that you use a USB terminal conforming to USB2.0 when connecting the DVD video camera/recorder.	—
Application is not normally run on PC.	Turn the PC and DVD video camera/recorder off, and try again.	—
Error occurs during writing to DVD-R disc.	The temperature of DVD video camera/recorder is too high due to continuous operation. Disconnect the DVD video camera/recorder from PC once, remove the disc from the DVD video camera/recorder, and then turn it off. After a few moments, connect them again and write to a brand-new disc.	—
Transfer of images stops.	Connect the DVD video camera/recorder to another USB terminal of PC. If your PC is a desktop type, it is recommended that you use USB terminal on the back of PC. If you are using USB2.0 extended card, it is also recommended that you install the newest version driver provided by each USB2.0 card maker.	—
DVD-RAM/R/RW drive built into PC cannot be used after the provided software has been installed.	This problem may be solved if the software related to DVD-RAM/R/RW of your PC is upgraded, or if the UDF driver is uninstalled. However, with Windows® 98 Second Edition / Me / 2000 Professional, uninstalling the UDF driver will make it impossible for the JPEG stills recorded on DVD-RAM of this DVD video camera/recorder to be read by the PC.	—
DVD-R disc cannot be played back on DVD-MovieAlbumSE.	DVD-MovieAlbumSE does not support playback or data read on DVD-R disc: Use generally available DVD video playback software to play back DVD-R disc on PC.	139
Error appears when starting DVD-MovieAlbumSE.	Make sure that your PC display adapter (video card) conforms to DirectX8.1.	—

Symptom	Cause and Correction	Reference page
Video written to hard disk of PC cannot be edited on DVD-MovieAlbum copy tool.	DVD-MovieAlbumSE cannot edit DVD-VR data stored on hard disk of PC: Copy the data to another DVD-RAM disc and then edit it.	—
Movies are not recognized by application in PC.	Make sure the power switch of this DVD video camera/recorder is set to "VIDEO", "PHOTO" or "CARD PHOTO".	—
The DISC EJECT button is not valid when the DVD video camera/recorder is connected to PC.	While the DVD video camera/recorder is connected to PC, use Explorer to right-click the DVD video camera/recorder drive icon and execute "Eject".	—
The DVD-RAM drive of DVD video camera/recorder cannot be opened by PC Explorer or application. Error appears. Disc cannot be ejected.	If DVD-MovieAlbumSE is running, terminate it.	—
When the time stamp of file in DVD-RAM is viewed on PC, it is different from the actual recording time.	The file system of this DVD video camera/recorder is operated on Greenwich Mean Time (GMT), and time lag information has not been set. With Windows® as of January, 2003, the time stamp of file viewed on Explorer looks different from the actual recording time. The actual recording time will appear for date/time indication on playback screen.	—
When DVD-MovieAlbumSE is started, "Disc in Drive X: cannot be used" appears.	A disc other than DVD-RAM is loaded in drive: DVD-MovieAlbumSE cannot be used for media other than DVD-RAM.	—
	Click the "Preference" button in the dialog box, click the "Device Setting" tab to choose the drive where DVD-RAM disc is loaded in the "Drive Select" column, and then click "OK".	—
An image that should have been recorded does not appear when DVD-MovieAlbumSE is started.	Click the "Preference" button at top right of DVD-MovieAlbumSE screen, click the "Device Setting" tab to choose the drive where DVD-RAM disc is loaded in the "Drive Select" column, and then click "OK".	—
"DISC ERROR" appears when releasing write-protect.	A disc that was write-protected using the write-protect setting tool (WPTOOL) equipped with the UDF driver on the CD-ROM provided with this DVD video camera/recorder cannot be released on this DVD video camera/recorder as is. Use the write-protect setting tool on PC to release the write-protect.	—
"USBNTMAP.SYS not found" appears while installing USB driver.	You have designated a folder which is different from that for Windows® when installing USB driver: Designate the correct folder.	—
No USB HS (high speed) connection even when USB2.0 card is used.	Make sure that you have already installed the driver provided with the USB2.0 card. You will need to install the driver provided by USB2.0 card maker in order to operate the USB2.0 card at HS (high speed).	143
Executing "Export" on DVD-MovieAlbumSE will interrupt reading midway.	Do not choose "Simple Export": If you do, reading will stop midway.	—

Symptom	Cause and Correction	Reference page
When executing "Export" on DVD-MovieAlbumSE, it will take time to read.	<ul style="list-style-type: none"> • If stills are included in the range of "export", it may take more time because data must be re-encoded and read. • If "Divide by Maker" is not chosen, it may take some time because data will be read while being re-encoded. 	143
"Hardware Removal" results in error.	Exit Windows® once, and then disconnect the DVD video camera/recorder. If your PC uses Windows® 2000 Professional, the problem may be solved if you install Windows® 2000 Service Pack 3 or later.	—

Miscellaneous

Symptom	Cause and Correction	Reference page
Power does not come on, or no operation occurs by pressing button.	Execute system reset (press the RESET button).	163
	Has the DVD video camera/recorder been subjected to impact? The DVD video camera/recorder could be damaged. Consult your dealer.	—
The date and time are incorrect.	Has the DVD video camera/recorder been left unused for a long period of time? The internal backup memory battery may be discharged: Charge it.	48
No scene can be deleted.	Is the cursor placed on the scene to be deleted? If the selected scene (framed in red) exists, that scene will be deleted even if you use yellow cursor to select any scene. Check the colors of cursors and bar graph on the thumbnail screen.	96
Disc cannot be removed.	Did you detach the battery or AC adapter/charger before setting the power switch to "POWER OFF"? Connect the battery or AC adapter/charger, set the power switch to "VIDEO" and then "POWER OFF", and remove the disc.	40, 45
DVD video camera/recorder cannot be operated from remote control.	Is the remote control pointed at the infrared receiver on DVD video camera/recorder? Point it at the infrared receiver to operate the DVD video camera/recorder.	35
	Is the infrared receiver on DVD video camera/recorder exposed to direct sunlight or strong fluorescent light, etc.? The remote control cannot operate the DVD video camera/recorder when strong light strikes the infrared receiver. Adjust the place or angle of the DVD video camera/recorder.	35
	Is there battery in the remote control? Also check the polarities of battery. The battery could be dead: Try replacing it.	34
	Is the DVD video camera/recorder powered? Turn it on.	45
Disc cover cannot be closed.	Is disc correctly inserted? Was disc inserted from wrong direction? Remove the disc and then reinsert it.	41
Operating sound is heard cyclically.	This sound is heard because the disc is cyclically operated and does not indicate a fault.	—
Some vibrations are felt or slight sound is heard from mechanism.	These vibrations or sound are caused by disc drive: This does not indicate a fault.	—

System Reset

If the DVD video camera/recorder does not operate normally, perform "System Reset": The DVD video camera/recorder may recover to normal. "System Reset" will reset all settings to factory defaults. The date and time will also be reset: Set the date and time again before using the DVD video camera/recorder.

- 1 Set the power switch to "POWER OFF" to turn the DVD video camera/reorder off.

Detach the battery or AC adapter/charger.

- 2 Use a fine tipped pen to hold down the reset button for several seconds.

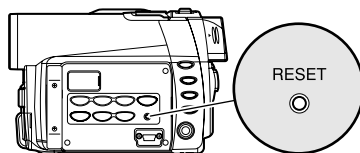

All settings will be reset.

Note:

Do not press the reset button with undue force.

● List of setting items

	Item	Default	Setting method
Camera Functions Setup	Program AE	Auto	P. 80
	White Bal.	Auto	P. 81
	EIS	On	P. 83
	Dig.Zoom	40x	P. 84
	MIC.Filter	Off	P. 85
Record Functions Setup	VIDEO Mode	FINE	P. 86
	Quality	FINE	P. 87
	Input Source	CAMERA	P. 88
	PHOTO Input	Field	P. 88
	Self Timer	Off	P. 89
	OSD Output	On	P. 90
Date Setup	Date Mode	M/D/Y	P. 49
	Date Set	1/1/2003 12:00AM	P. 48
LCD Setup	Brightness	- <input type="text"/> +	P. 91
	Color Level	- <input type="text"/> +	P. 91
Initial Setup	Beep	On	P. 92
	Power Save	Off	P. 92
	Record LED	On	P. 93
	Language	English	P. 93
	Demo Mode	Auto	P. 146

* Some items will not appear depending on the disc or card inserted.

Major Specifications

CCD		DZ-MV350A: 1/4-inch interlaced DZ-MV380A: 1/3.8-inch interlaced
		Total number of pixels DZ-MV350A approx. 680,000 DZ-MV380A approx. 1,020,000 Number of effective pixels DZ-MV350A Movie: approx. 340,000 Still: approx. 340,000 DZ-MV380A Movie: approx. 400,000 Still: approx. 960,000
Lens		DZ-MV350A: F1.8-2.5, f = 1/8"-1-4/1" (3.15-31.5 mm) DZ-MV380A: F1.8-2.4, f = 3/16"-1-1/2" (3.8-38mm) Filter diameter DZ-MV350A 1-3/16" (30.5 mm) DZ-MV380A 1-7/16" (37 mm)
Focus		Auto/Manual
Zoom		Optical 10x, 40x-240x with digital zoom added (40x for still)
Required minimum illumination		0.3 lx : When Low Light mode is selected
Viewfinder		0.44-inch color TFT (approx. 110,000 pixels)
LCD monitor		2.5-inch color TFT (approx. 120,000 pixels)
Electronic image stabilizer		Electronic type
Shutter speed		1/60 - 1/4000 second (movie)
Self-timer recording		Still recording only
External microphone jack		ø3.5 mm stereo mini-jack: (a plug-in power type microphone cannot be used)
Recording mode		Movie (with sound) Still (with DVD-RAM disc, SD memory card, MultiMediaCard)
Maximum recordable time (per side)	DVD-RAM disc	approx. 18 minutes (XTRA) approx. 30 minutes (FINE) approx. 60 minutes (STD)
	DVD-R disc	approx. 30 minutes (FINE) approx. 60 minutes (STD) approx. 30 minutes (LPCM)
Maximum number of recordable stills	DVD-RAM disc (per side)	999. However, if movies and stills are mixed on one disc, the recordable number will decrease.
	SD memory card (when using 32 MB card)	DZ-MV350A approx. 220 (in FINE mode) DZ-MV380A approx. 50 (in FINE mode) Varies depending on the recording quality and the type of card. (P. 27)

Recording format	DVD-RAM disc	Movie: Conforming to DVD video recording standard (MPEG Audio layer 2) Still: Simultaneous recording, conforming to DVD video recording standard (704 × 480 pixels) and JPEG (DZ-MV350A: 640 × 480 pixels, DZ-MV380A: 1280 × 960 pixels)
	DVD-R disc	Movie: Conforming to DVD video recording standard (when MPEG Audio layer 2 or LPCM* is selected)
	Card	Still: Conforming to JPEG (DZ-MV350A: 640 × 480 pixels, DZ-MV380A: 1280 × 960 pixels) standard
Audio playback format		MPEG Audio layer 2, linear PCM, Dolby AC3
Recording medium		8 cm DVD-RAM disc (conforming to DVD-RAM Ver. 2.1 Book 2.1) 8 cm DVD-R disc (conforming to DVD-R for General Ver. 2.0) SD memory card, multimedia card
Jacks		Video/audio input/output × 1, External microphone input × 1, PC connection terminal (connected to PC USB port) × 1
Battery system		Lithium-ion
Power consumption		When recording with LCD monitor off DZ-MV350A approx. 4.7W (in FINE mode) DZ-MV380A approx. 5.0W (in FINE mode)
Dimensions (W × H × D)		DZ-MV350A approx. 2-1/4" × 3-1/2" × 5-1/4" (57 × 89 × 134 mm) (excluding projections) DZ-MV380A approx. 2-3/8" × 3-11/16" × 5-13/16" (60 × 93 × 148 mm) (excluding projections)
Operating temperature (humidity)		32-104 °F (0-40 °C) (less than 80%). 32-86 °F (0-30 °C) when connected to PC
Storage temperature		16.8-140 °F (-20-60 °C)
Weight		DZ-MV350A approx. 480 g (without battery or disc) DZ-MV380A approx. 505 g (without battery or disc)
Total weight when recording		DZ-MV350A approx. 565 g DZ-MV380A approx. 590 g
Provided accessories		AC adapter/charger, battery, AV/S input/output cable, infrared remote control, Lithium battery for remote control, lens cap, lens cap string, shoulder strap, power cable, DC power cord, ferrite core, Software CD-ROM, PC connection cable, 8 cm DVD-R disc (in Round DVD Holder)

* The MPEG Audio layer 2 format is an option of DVD video standard. If your DVD player does not conform to MPEG Audio layer 2, record in LPCM mode and the finalized DVD-R disc can later be played back on that DVD player.

Introduction to Optional Accessories

CAMERA ACCESSORIES

Wide conversion lens (DZ-WL1)



Tele-conversion lens (DZ-TL1)



Video flash (DZ-FLH3)

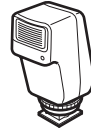

- When using optional accessories, be sure to read the instruction manuals for each accessory.
- Unusable on DZ-MV350A.

POWER SUPPLY

Battery (DZ-BP14SW)

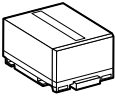

INFORMATION ON SQUARE ADAPTER

This DVD video camera/recorder cannot use a square adapter, such as for 8 cm DVD-RAM disc (DRMS-V28R), 8 cm DVD-R disc (DR30.1P): Remove the disc from square adapter and set it in Round DVD Holder, referring to the instruction sheet of disc.

● Removing disc from square adapter

(Example 1)

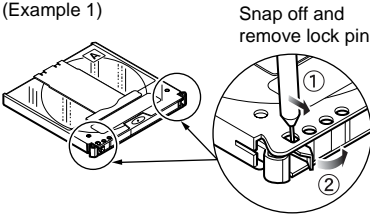

(Example 2)

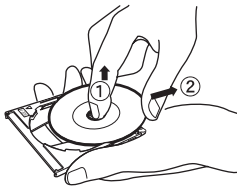

Slide the disc obliquely upward so that it is not caught by claws.

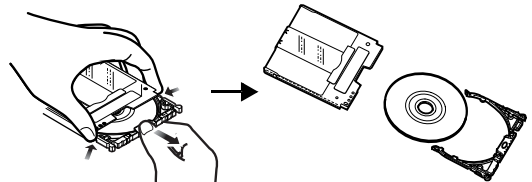

Note:

Refer to page 76 if you want to correctly set the removed disc in Round DVD Holder that can be used in this DVD video camera/recorder.

BY PHONE

1-800-HITACHI
(1-800-448-2244)

**FOR AUTHORIZED HITACHI SERVICE
FACILITY IN CANADA**

Please consult the following telephone number:
1-800-HITACHI
(1-800-448-2244)

**TO ORDER ACCESSORIES
(Canada only)
BY PHONE**

**HITACHI CANADA LTD.
DIGITAL MEDIA DIVISION**
6740 Campobello Road,
Mississauga, Ontario
L5N 2L8
Phone: 1-800-HITACHI
(1-800-448-2244)

during business hours

Monday-Friday EST 9:00am-7:00pm
Saturday EST 9:00am-5:00pm

DECLARATION OF CONFORMITY

with FCC Rules for Electromagnetic Compatibility

Products: DVD VIDEO CAMERA/RECORDER
Models: DZ-MV350A/DZ-MV380A
Trade Name: HITACHI

This device complies with part 15 of FCC Rules.

Operation is subject to the following two conditions: (1) this device may not cause harmful interference, and (2) this device must accept any interference received, including interference that may cause undesired operation.

Responsible Party: HITACHI AMERICA, LTD.
HOME ELECTRONICS DIVISION
1855 Dornoch Court, San Diego,
CA 92154-7225 U.S.A
Tel: 619-661-0227

Choisissez les articles qui vous conviennent et passez commande.
Appelez le numéro gratuit "1-800-HITACHI (1-800-448-2244)".

**POUR COMMANDER DES
ACCESSOIRES
(Canada seulement)
PAR TÉLÉPHONE**

**HITACHI CANADA LTD.
DIGITAL MEDIA DIVISION**
6740 Campobello Road,
Mississauga, Ontario
L5N 2L8
Phone: 1-800-HITACHI
(1-800-448-2244)

Durant les heures de bureau:

Lundi au vendredi 9:00am-7:00pm (h.n.e)
Samedi 9:00am-5:00pm (h.n.e)

Numerics

240x (Dig.zoom)	84
40x (Dig.zoom)	84
8 cm DVD-R disc	22
8 cm DVD-RAM disc	22

A

AC adapter/charger	40
ACCESS/PC indicator	50, 53
Add (edit)	121
All programs	114
Auto (program AE)	80
Auto-focus	57
AV input/output jack	72

B

Backlight correction	60
Battery	36
Attaching to DVD video camera/recorder	37
Charging	36
Recordable time on DVD video camera/ recorder	38
Removing from DVD video camera/ recorder	37
Setting Up	36
BATTERY EJECT button	37
Beep	92
Black & White fade	105
Brightness	91

C

Camera Functions Setup	80
Capacity	126
Card	
Available	25
Capacity	27, 126
Category	130
Format	127
Handling	25
Quality	87
Card Access indicator	53
CHARGE indicator	36
Cleaning	145
Color Level	91
Connecting	
to Other AV Device	65
to TV	72
Copy	109
Create	117

D

Date and time	48
Date setup	48
Defaults	94
Delete (edit)	122
Delete (play list)	124
Delete (scene)	101, 121

Demo Mode	146
Detail (scene)	113
Dig. zoom	84
Diopter control	46
Disc	22
Available	22
Capacity	26
Finalize Disc	129
Format	127
Handling	24
Protect	126
Update Control Info.	128
DISC EJECT button	43
Disc guide	41
Display	62
Information LCD	62
Scenes information	113
Viewfinder	46
Divide	108
DPOF	111
DVD-R	22
DVD-RAM	22

E

Edit (play List)	121
EIS	83
EXPOSURE button	59
Exposure control	59
External microphone jack	52

F

Fade	105
Ferrite core	52
FIELD (PHOTO Input)	88
Finalize Disc	129
FINE (VIDEO Mode)	86
FOCUS button	57
Format Disc	127
FRAME (PHOTO Input)	88
Frame advance/Frame back	68
FULL AUTO button	61

G

Go To (during playback)	70
Go To (on Disc Navigation)	125

H

Hand strap	32
------------------	----

I

Information display mode	62
Infrared receiver	35
Initial Setup	92
Input Source	88

L	
Language	93
Lens cap	32
Lock	110
Low Light (Program AE)	80
LPCM (VIDEO Mode)	86

M	
MENU button	79
MF	57
MIC.Filter	85
Move	123

O	
Optical 10x zoom lens	17
OSD Output	90

P	
PHOTO Input	88
Play (play list)	119
Play (program)	115
Play list	117
Add scenes	120
Add scenes (submenu)	121
Create	117
Delete	124
Delete scenes	121
Delete scenes (submenu)	122
Move	123
Play	119
Select scenes (submenu)	122
Switch	118
Title	124
Portrait (Program AE)	80
Power Save	92
Power switch	45
Program	114
Play	115
Switch	114
Title	115
Program AE	80
Protect Disc	126

Q	
Quality (Card)	87

R	
Record button	50
Recording indicator	93
Remote control	34
Repeat Play	130
Reset	94
settings	94
system	163
RESET button	163

S	
Sand & Snow (Program AE)	80
Scene	
Combine	107
Delete	101
Detail	113
Divide	108
Fade	105
Move	123
Select	112
Skip	104
Searching for image	68
Select (Scene)	98
SELECT button	98
Self Timer	89
Shoulder Strap	33
Skip (Scene)	104
Skip playback	69
Slide Show	131
Sports (Program AE)	80
Spotlight (Program AE)	80
STD (VIDEO Mode)	86
Stereo microphone	50
Submenu	102
Switch (play list)	118
Switch (program)	114

T	
Tele-conversion lens	56
Thumbnail	96
Title (play list)	124
Title (program)	115

U	
Update Control Info.	128

V	
Video flash	54
VIDEO Mode	86
FINE	86
LPCM	86
STD	86
XTRA	86
Vol. button	67

W	
White Bal.	81
White fade	105
Wide conversion lens	56
Wipe fade	105

X	
XTRA (VIDEO Mode)	86

Z	
Zoom lever	55

Be sure to read the following before opening the package of CD-ROM

This Agreement will take effect at the moment you open the package of the storage device (CD-ROM) provided with this product, if you agree to the terms herein.

If you do not accept the terms of this Agreement, immediately return the unopened package of storage medium and enclosed materials (printed matter, external package, and all others) to your dealer, or return only the package of storage medium to your dealer.

Consult your dealer for any refund on the unused product. However, if only the package of storage medium is returned, no refund is possible.

This License Agreement certifies that you were granted license in the past.

License Agreement

Article 1 Grant of License

Hitachi, Ltd. grants you the following rights for the following products (to be referred to as "This Software" hereafter) that you have obtained with this Agreement:

- (a) You may use This Software only on a single piece of equipment. However, if this equipment cannot be used because of mechanical problem, you may temporarily use This Software on another piece of equipment.
- (b) Although This Software contains several components that can be run on computer as independent functions, all components are licensed as a single product: You may not, by any means, use these components on different computers at the same time.

Article 2 Copyrights

The copyrights of This Software, attached manual, etc. are owned by the following corporations, and are protected by copyright laws in Japan and USA, as well as by other intellectual property and international properties:

Name of Software	Copyright Owners
USB device driver for DVDCAM	Hitachi, Ltd.
UDF driver (DVD-RAM driver)	Matsushita Electric Industrial Co., Ltd.
DVD-MovieAlbumSE	Matsushita Electric Industrial Co., Ltd.
MyDVD	Sonic Solutions

Article 3 Other Rights and Limitations

- (a) You may not copy This Software or any of the printed materials attached, except for duplications to provide back-up or storage.
- (b) Use of This Software by third parties is prohibited, whether by transferring, renting, leasing, lending, moving, or any other measures.
- (c) You may not decompile or disassemble this Software.
- (d) Duplication and/or distribution of any files on this storage medium for commercial use is prohibited.

Article 4 Quality Assurance

Under no circumstances will Hitachi, Ltd., Matsushita Electric Industrial Co., Ltd. or Sonic Solutions accept any responsibility for any damages you may incur from using or being unable to use This Software (including, but not limited to, loss of business profit, interruption of business, loss of business information, or other monetary damages).

Article 5 Termination of Agreement

If you fail to comply with the terms of this Agreement, Hitachi, Ltd., Matsushita Electric Industrial Co., Ltd. and Sonic Solutions reserve the right to terminate the Agreement. In such a case, you will be obliged to discard all copies of This Software and its components.

Article 6 Prioritized License Agreement

When some software programs are installed, the license agreements will be displayed (to be referred to as online license agreement).

If the online license agreement conflicts with this Agreement, the online license agreement shall have a priority.