

DC 3550 User's Manual

Digital Camera

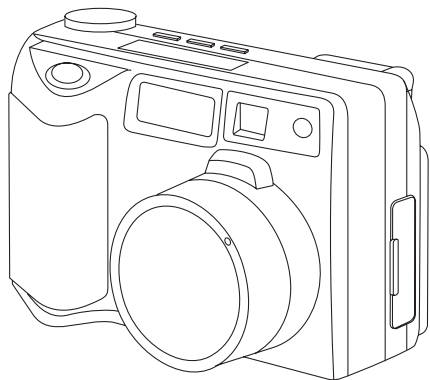

USER'S MANUAL

E

Table of Contents

| | | | |
|---------------------------------|-----------|--|-----------|
| Getting Started | 1 | Viewing Pictures | 20 |
| Welcome | 1 | Playback Pictures | 20 |
| Contents of Package | 2 | Display a Movie | 21 |
| System Requirements | 3 | Deleting Pictures | 22 |
| Dc3550 Nomenclature | 4 | Managing Pictures | 22 |
| Accessory Set-up | 6 | | |
| Powering Up | 7 | Connecting External Equipmen | 23 |
| Battery Installation | 7 | Television Display Output | 23 |
| Using the AC adapter | 8 | PC Display Output | 24 |
| Compact Flash Card Installation | 9 | | |
| Ejecting the Compact Flash Card | 9 | Installing Software | 27 |
| Formatting Compact Flash Card | 9 | How to install driver for Windows98(other OS without) | 32 |
| Date and Time Adjustment | 10 | How to install MGI PhotoSuite8.21SE software | 43 |
| | | How to install QuickTime5 software | 61 |
| Recording Images | 10 | Accessories | |
| Using the Navigation Dial | 10 | FAQ(Frequently Asked Questions) | 76 |
| Recording Mode Screen | 11 | Specifications | 78 |
| LCD Panel Control Screen | 13 | QSG(Quick Start Guide) | 81 |
| Taking Pictures | 14 | | |
| Using Zoom | 14 | | |
| Macro Mode | 15 | | |
| Exposure Compensation | 16 | | |
| White Balance | 16 | | |
| Using the Flash | 17 | | |
| Self-Timer | 18 | | |
| LCD Brightness | 18 | | |
| Beep Sound | 19 | | |
| Taking a Movie | 20 | | |

Welcome to the Exciting World of Argus Camera

Thank you for choosing Argus Camera to pursue your video adventures. Whether you are creating memories of your friends and family or exploring the great outdoors, since 1936 Argus Camera has been there, sharpening your images with leading edge technology. To get the utmost satisfaction from your DC3550 digital camera please take a moment to read through this manual. Its contents will send you on an educational journey into your camera's multiple capabilities.

Thank you again for choosing Argus!

- This camera is not resistant to water and should not be used outdoors in snow or rain. If accidentally dropped in water, please quickly pour out the water. Dry it with sunlight or an air-blower.
- Protect it from excessive humidity. It will wet the lens and the pictures taken will be blurred.
- Do not attempt to disassemble the camera yourself. Always take it to an authorized service facility for repair.
- To store the camera, wrap it in a piece of clean, soft cloth and place it in a cool, dry, dust-free place.
- Performance may be limited using 1.5V batteries in low temperatures. Do not use Manganese batteries as they may overheat and destroy the camera.

Contents of Package

- DC 3550 camera
- USB cable
- Video cable
- User's Manual
- Installation CD-ROM
- Wrist strap
- Lens cap strap
- Lens cover
- 4- AA 1.5V batteries

System Requirements

Intel 486 or higher CPU (intel pentium® processor or higher recommended)

Microsoft Windows98/Me/2000/XP operation system

At least 16MB RAM

80MB harddisk space

CD-ROM driver

Microsoft Mouse or compatible mouse device

DC3550 Nomenclature

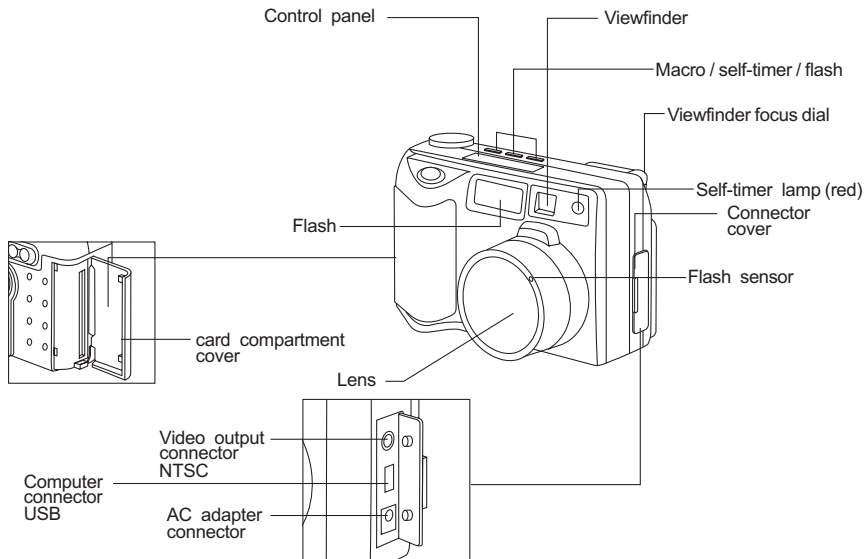

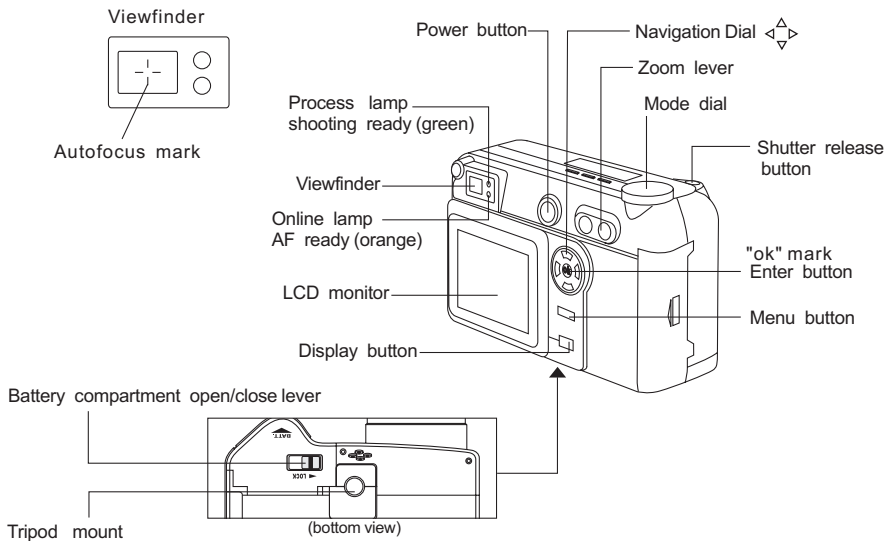

Accessory Set-up

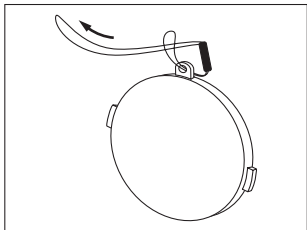

Figure 1

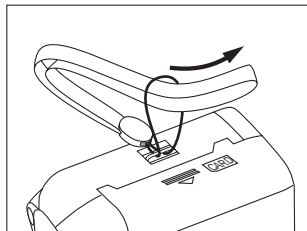

Figure 2

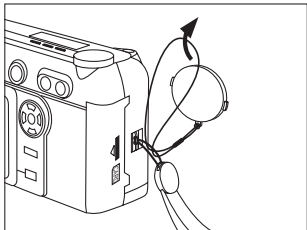

Figure 3

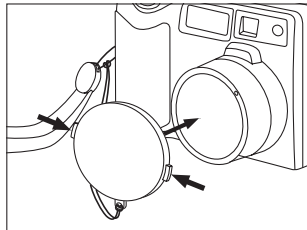

Figure 4

E

Powering Up

Battery Installation

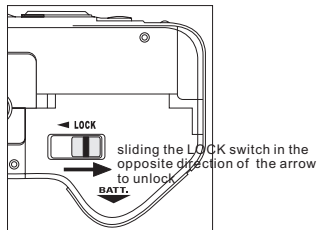

Figure 1

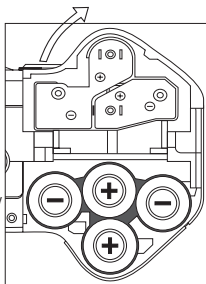

Figure 2

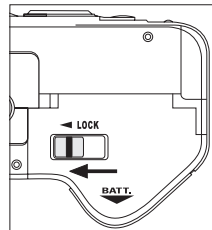

Figure 3

1. Be sure that power is OFF.

Unlock the battery compartment by sliding the LOCK switch in the opposite direction of the arrow. See Figure 1.

2. Open battery chamber cover.

Insert 4 AA batteries into the battery chamber. Be sure to use correct polarity as shown on the battery chamber inside cover. See Figure 2.

3. Close battery chamber cover.

Slide the LOCK switch in the direction of the arrow to secure the battery compartment closed. See Figure 3..

Using the AC Adapter

An optional AC adapter allows you to power your digital camera from a common AC wall outlet.

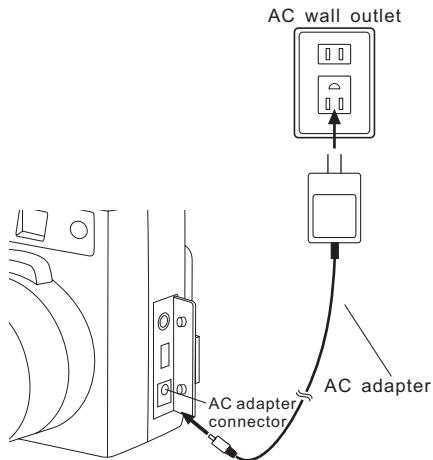

1. Be sure that power is OFF.
2. Open the Connector cover and plug the AC adapter into the AC adapter connector on the camera. See illustration.
3. Plug the AC adapter into a power outlet. See illustration.
4. To disconnect, turn off the power, and unplug the AC adapter first from the camera then from the outlet.

Note:

When in use for long periods, the AC adapter may get warm. This is normal.

Compact Flash Card Installation

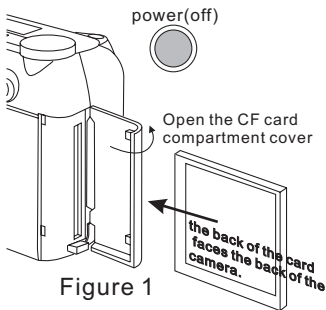

Figure 1

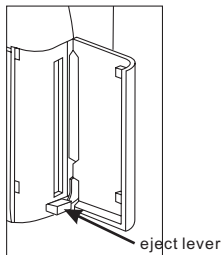



Figure 2

1. Be sure that the camera is OFF.
2. Open Card compartment cover.
3. Insert the CF card into the slot. Be sure that the CF card is in the upright position and the back of the card faces the back of the camera.
4. Close the CF card slot.



Ejecting the Compact Flash Card:



1. Turn OFF camera power.
2. Open the Card compartment cover.
3. Push the eject lever to eject the card.
See Figure 2

Formatting the CF Card





1. Set the Mode dial to .
2. Press the **Menu** button to display the Menu.
3. Move  arrows on the navigation to **"FORMAT"** and press **"ok"**.
4. Confirm **"FORMAT/SURE?"** with **"ok"** then auto run **■■■■■■■■ COMPLETE**

Date and Time Adjustment

1. Set the Mode dial to "  " and press **MENU** to display.
2. Press the  arrow on the navigation dial to select **DATE** mode, and press "OK"

 used to move the item,
 used to change the value ,
press "OK".



























Recording Images

1. Turn mode to  or 
2. Press **MENU** to display the menu screen
3. Press the **navigation** arrow  to toggle through the items.
4. Press "OK" to select "**Date**" and "**Format**" item.
5. Use the **navigation** arrow  to select condition elements.
6. press "OK" when condition element is selected.
7. Use the **navigation** arrows  to adjust the "**Date**" value of specified condition . Press "OK" to complete selection.



Recording Mode Screen

When the Mode dial is set to  or .

| Monitor display | Use | | | | | | | | | | | | | | | | | | | | | | | | |
|--|-------------------|---|------|--------------|---|---|------|----|----|-----|-------------|--|-----|------|---|------|----------|--|------|------------------|--|--------|-------|--|---|
| <p> MOVIE MODE MENU</p> <table border="1" data-bbox="104 329 495 425"> <tr> <td>LCD</td> <td>- ■ ■ □ □ +</td> </tr> <tr> <td>BEEP</td> <td>OFF LOW HIGH</td> </tr> </table> | LCD | - ■ ■ □ □ + | BEEP | OFF LOW HIGH | <p>BUTTON :</p> <p>press SELFTIMER to switch:  Selftimer lamp blinks</p> <p>press FLASH to switch:     </p> <p>press MACRO to switch:  </p> | | | | | | | | | | | | | | | | | | | | |
| LCD | - ■ ■ □ □ + | | | | | | | | | | | | | | | | | | | | | | | | |
| BEEP | OFF LOW HIGH | | | | | | | | | | | | | | | | | | | | | | | | |
| <p> STILL MODE MENU</p> <table border="1" data-bbox="104 505 495 888"> <thead> <tr> <th>ITEM</th> <th colspan="2">CONDITION ELEMENT</th> </tr> </thead> <tbody> <tr> <td>SIZE</td> <td>L</td> <td>S</td> </tr> <tr> <td>QUAL</td> <td>HQ</td> <td>SQ</td> </tr> <tr> <td>LCD</td> <td colspan="2">- ■ ■ □ □ +</td> </tr> <tr> <td>W B</td> <td>AUTO</td> <td>   </td> </tr> <tr> <td>LANG</td> <td colspan="2">EN GR FR</td> </tr> <tr> <td>DATE</td> <td colspan="2">2002.09.20 15:45</td> </tr> <tr> <td>FORMAT</td> <td colspan="2">SURE?</td> </tr> </tbody> </table> <p style="text-align: center;">each value of condition element</p> | ITEM | CONDITION ELEMENT | | SIZE | L | S | QUAL | HQ | SQ | LCD | - ■ ■ □ □ + | | W B | AUTO |     | LANG | EN GR FR | | DATE | 2002.09.20 15:45 | | FORMAT | SURE? | | <p>SETTING :</p> <p>Press MENU to modify :</p> <p>SIZE → L → S → "ok"</p> <p>QUALITY → HQ → SQ → "ok"</p> <p>LCD BRIGHTNESS ADJ. → - ■ ■ □ □ + → "ok"</p> <p>WHITE BALANCE → AUTO →  sunny →  cloudy →  fluorescent lamp →  indoor → "ok"</p> <p>LANGUAGE → ENGLISH → GERMAN → FRENCH → "ok"</p> <p>DATE ADJ. "ok" → 2002 → 09 → 20 → 15 → 45 → "ok"</p> <p>FORMAT first "ok" → then sure? → "ok" → ■■■■■■■■ COMPLETE</p> |
| ITEM | CONDITION ELEMENT | | | | | | | | | | | | | | | | | | | | | | | | |
| SIZE | L | S | | | | | | | | | | | | | | | | | | | | | | | |
| QUAL | HQ | SQ | | | | | | | | | | | | | | | | | | | | | | | |
| LCD | - ■ ■ □ □ + | | | | | | | | | | | | | | | | | | | | | | | | |
| W B | AUTO |     | | | | | | | | | | | | | | | | | | | | | | | |
| LANG | EN GR FR | | | | | | | | | | | | | | | | | | | | | | | | |
| DATE | 2002.09.20 15:45 | | | | | | | | | | | | | | | | | | | | | | | | |
| FORMAT | SURE? | | | | | | | | | | | | | | | | | | | | | | | | |

| Monitor display | Use | | | | | | | | | |
|---|--|-----------|-------|----|-----|-----------|----|-----|-----|--|
| ▶ S | LCD will display the last image of still picture. | | | | | | | | | |
| ▶ M | LCD will display the last image of movie picture. | | | | | | | | | |
| <table border="1" data-bbox="109 385 435 498"> <tr> <td>▶</td> <td>MULTI</td> <td>SLIDE</td> </tr> <tr> <td>🗑️</td> <td>ONE</td> <td>ALL SURE?</td> </tr> <tr> <td>0→</td> <td>ONE</td> <td>ALL</td> </tr> </table> | ▶ | MULTI | SLIDE | 🗑️ | ONE | ALL SURE? | 0→ | ONE | ALL | <p>Press MENU allows you to specify whether the photographed image is displayed after you take a picture.</p> <p>SET DISPLAY MODE → MULT1 → SLIDE(continue to be display) → "ok" PROTECT → one → all → "ok" LOCK? → "ok" ■■■■■■■■ COMPLETE DELETE → one → all → "ok" SURE? → "ok" ■■■■■■■■ COMPLETE</p> <p>MULTI FRAMES MODE :</p> <p>MENU → MULTI "ok" Repress \updownarrow to switch multi frames respectively. Use \updownarrow "ok" to display the image from 6 frames. Press W if you want to resume and select another Press MENU to specify the photographed image under single frame mode.</p> <p>SLIDE MODE :</p> <p>MENU → slide "ok" The images that are displayed will be a slide. Press "ok" to pause.</p> <p>ENLARGE : You can enlarge the preview to check the image: Zoom in different parts of the image. T \updownarrow \oplus 2X T \updownarrow \oplus 4X Zoom out to revert when press "ok" .</p> |
| ▶ | MULTI | SLIDE | | | | | | | | |
| 🗑️ | ONE | ALL SURE? | | | | | | | | |
| 0→ | ONE | ALL | | | | | | | | |

E

LCD Panel Control Screen

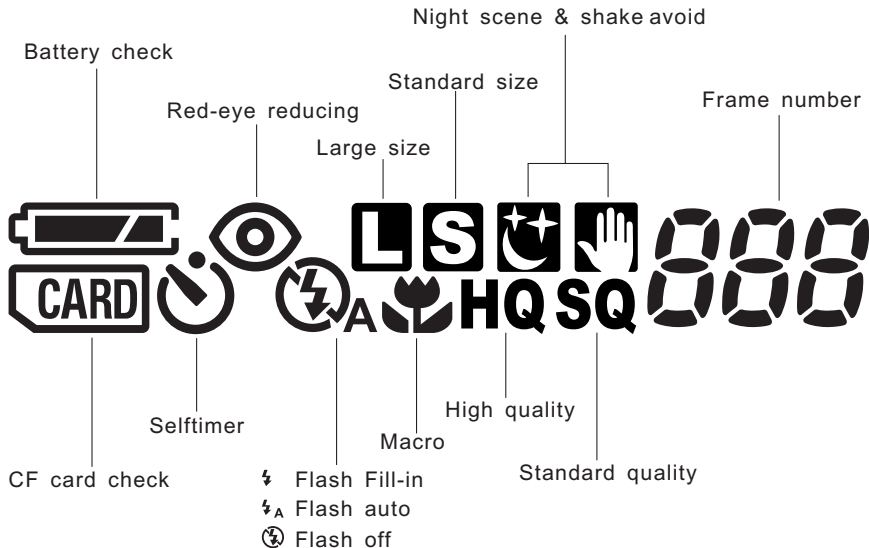

Taking Pictures

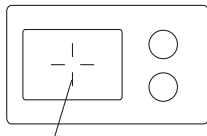

Taking pictures using the optical viewfinder.

Viewfinder



Autofocus mark

Figure 1

1. Set the Mode dial to  or .
2. Compose the picture by placing the subject within the autofocus marks in the viewfinder. See Figure 1.
3. Press the shutter release button halfway to lock the focus and exposure.
(When the orange lamp blinks, focus or exposure is locked.)
Press the Shutter release button fully to take the picture.

Using Zoom

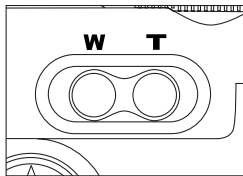

Figure 2

Press the " T " to choose telephoto shooting. See figure 2.
Press the " W " to choose wide-angle shooting. See figure 2.

NOTE:

- When using the Digital tele mode, your picture will appear approximately six times larger
- The setting will be canceled when the power is turned OFF.

Macro Mode

You can take photographs in macro mode as close as 0.2 meters. A subject that is approximately 6 X 8cm can be photographed fully within the frame.

1. Set the Mode dial to  or .

2. Press the Macro button until  appears on the control panel.

To cancel the Macro mode, press the Macro button again until the  disappears.

3. Take a picture.

Control panel



Shooting Range: approximately 0.66' (0.2m)~1.64' (0.5m)

Note:

- When using the flash in the Macro mode, the flash may not have the proper effect. Confirm the result using the LCD monitor.
- Using the LCD monitor as a viewfinder makes it easy to take the close-up pictures.
- The setting will be canceled when the power is turned to OFF.
- When using movie record mode in Macro mode, the camera has an effect similar to Digital TEL mode.



Exposure Compensation

In addition to automatic exposure, you can also adjust it manually.

- Use - to adjust when the subject is mostly bright
- Use + to adjust when the subject is mostly dark
- The flash sensor controls the exposure when the camera is in flash mode.

1. Set the Mode dial to  or .

2. When Mode dial is selected, the exposure setting will be displayed. like: "0/3EV"
it meaning that "±2EV in 1/3EV steps , approx. -6/3EV~+6/3EV"

Press the  arrow on the navigation dial for + adjustment and the  arrow for - adjustment.

Note:

- Not available in the Manual mode.
- The setting will be canceled when the power is turned off.
- The exposure compensation may not work properly when shooting with the flash.

White Balance

1. Set the Mode dial to .

2. Press the Menu button to display the Menu.

3. Press the  arrows on the navigation dial to select "WB".

4. Press the  arrows on the navigation dial to select AUTO, SUNNY, CLOUDY, INDOOR or FLUOR.







5. Press the "ok" to confirm the setting.

Using the Flash

Select the mode according to shooting conditions.



You can toggle to the next flash mode by pressing the Flash button.



| Flash mode | | Use |
|---------------------------------------|---|--|
| Auto-Flash |  | Automatically flash in low-light and backlight conditions. |
| Red-eye reducing Flash |  | Reducing the subject's eye appearing red. |
| Fill-in Flash (Flash always fires) |  | Regardless of available flash. |
| Flash Off (Flash dose not fire) |  | Never flash. |
| Night Scene |  | Slow shutter speed mode with speed as slow 1 second. |

Flash working range: approximately 2.62' (0.8m)~18.37' (5.6m)

Note:

- A blinking green lamp signifies the flash is the time of charge, Wait until the green lamp is not blinking to take the picture.
- When using the flash in the Macro mode, especially with wide-angle shooting, the flash may not have the proper effect. Confirm the result using the LCD monitor.
- Flash cannot be enough time to charge in the Sequence mode.

Self-Timer

1. Set the Mode dial to .
 2. Press the self-timer button until  appears on the control panel.
 3. Place the Auto Focus mark over the subject and press the shutter button.
The camera focuses on the subject in the frame as the front red lamp is blinking.
 - In this mode a timer runs for roughly 10 seconds before the shutter is released.
 - To cancel the self-timer mode, press the self-timer button until  disappears.
- NOTE: When using the self-timer mode, the use of a tripod is recommended.





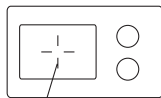









Viewfinder





Autofocus mark

LCD Brightness

1. Set the Mode dial to "  " or "  " and press **MENU** to display.
2. Press the   arrow on the navigation dial to select " LCD " mode, then press the   arrow to adjust LCD brightness .(     )
Finally, press "ok" to confirm it.

Beep Sound

1. Set the Mode dial to  and press **MENU** to display.
2. Press the  arrow on the navigation dial to select "BEEP" mode, then press the  arrow to adjust the setting "OFF LOW HIGH" and press "ok" button to conform.

Note:

- The setting will remain until it is readjusted.

Taking a Movie

1. Press **MENU** to set /exit.
2. Use **W T** to select wide angle or telephoto.
3. Press the shutter halfway to lock focus and exposure. See Figure 1.
4. Press the shutter fully, to record movie until the gauge is full. This usually happens within approximately 12 seconds. See Figure 2.

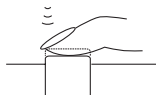

Figure 1

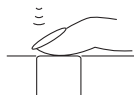

Figure 2

Viewing Pictures

Playback Pictures

Use **MENU** button to specify whether the image appears after picture is taken.

1. Set MODE dial to **▶s** and press **MENU** to display.
2. Select playback way to MULTI or SLIDE.
3. Select PROTECT **0** to protect images from being deleted.
4. Select DELETE **🗑** to erase images.

Multi Frame Mode:

1. Press **MENU** → **MULTI "ok"**.
2. Press **⬆** to toggle between multi frames mode.
3. Use **⬅** "ok" to display the image from 6 frames.
4. Press **W** if you want to resume and select another.
5. Press **MENU** to specify the photographed image under single frame mode.

Slide Mode:

1. Press **MENU** → **slide "ok"**.
2. The images that are displayed will be a slide.
3. Press **"ok"** to pause.

Enlarge Pictures using Zoom mode:

1. You can enlarge the preview to check the image.
2. Zoom in different parts of the image. **T** **⬅** **🔍 2X** **T** **⬅** **🔍 4X**
3. Pressing **"ok"** reverts picture to zoom out.

Display a Movie

Use **MENU** button to specify MOVIE mode.

1. Set MODE dial to **M** and press **MENU** to display.
2. Select PROTECT **0** to protect images from being deleted.
3. Select DELETE **🗑** to erase images.

Multi Frame Mode:

1. Press **MENU** → **MULTI "ok"** .
2. Press **↕** to toggle between multi frames mode.
Use **↔** "ok" to select and display the image from 6 frames.
3. Press **W** if you want to resume and select another.
4. Press **MENU** to specify the movie under single frame mode.

Slide Mode:

1. Press **MENU** → **slide "ok"** .
2. The images that are displayed will be a slide.
3. Press **"ok"** could be pause.

Play movie:

1. Press **"ok"** to play the movie when data is loaded.
2. Press **"ok"** again, could be pause or resume.

Deleting Pictures

1. Set the Mode dial to S or M
press the **MENU** → → MULTI, and "ok" to select the picture you want to delete.
2. Press the **MENU** and use **navigation** dial to select ↓ Use arrows → to choose ONE/ALL.
3. Press "ok" to select Delete one or Delete all.

Important

- Never open the card cover, eject the card, remove the batteries, or pull the plug while erasing pictures. It may destroy the data in the card.
- When the picture is protected or the write-protect adhesive seal " "MARK is placed on the picture the camera does not erase it.
Cancel the protection or remove the seal use " → "to switch "LOCK? /UNLOCK?" under " protect" mode.

E Managing Pictures

1. Set the Mode dial to S or M
Press the **MENU** → → MULTI, and "ok" to select the picture you want to protect.
2. Press the **MENU** and **navigation** dial to select ↓ , Use arrow → to choose ONE/ALL.
3. Press "ok" to select Protect one or protect all.

The protected picture will not be deleted with all-Frame erase. When using card format, it will erase all protected and unprotected pictures.



Note:

- The protected picture will not be deleted with All-Frame erase, but will be deleted with Card format. but "card format" will erase all the picture, can't choice or selection.
- Delete is not available when the write-protect adhesive seal is placed like "  MARK".
- The setting will remain until it is readjusted.

Connecting External Equipment

Television Display Output

Recorded images can be viewed on TV

1. Be sure the TV is OFF and the camera is OFF prior to connecting.
2. Connect the cable by inserting video connector between camera and television. See Figure 1.
3. Turn on the TV. See Figure 2.
4. Set the camera Mode dial to  M or  S.
5. Select a picture. Use instructions on page 20 Playback Picture to choose a picture.

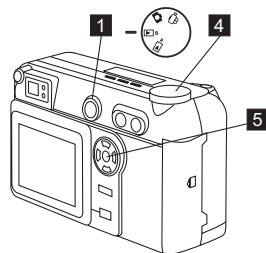
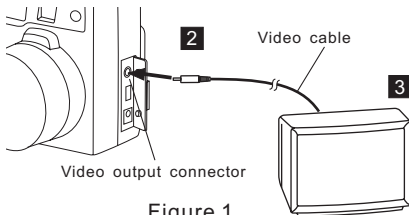

PC Display Output

Use the appropriate connector according to computer's platform.

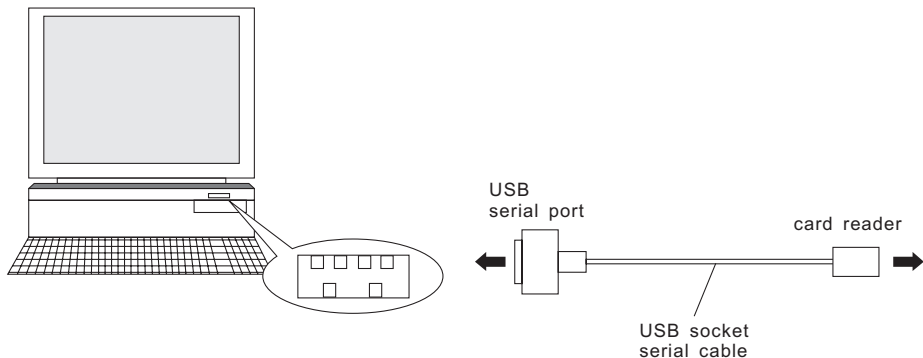

IBM PC/AT compatible
Connect the provided USB Socket serial
cable to the USB port on your computer.



Microsoft
Windows 98



PhotoSuite™

Version 8.21SE

Copyright © 1998 MGI Software
All Rights Reserved.



QuickTime 5

DC3550

How to install driver for Windows98(other OS without)

How to install MGI PhotoSuite8.21SE software

How to install QuickTime5 software

STI Protocol Image Process & Video Streaming



Installing Software

1. Insert the installation CD into the CD driver. The installation CD includes : MGI PhotoSuite8.21SE, QuickTime 5, USB driver for Windows 98 (other OS without driver installation).
2. Find appropriate file and click to open it , If you are using Windows Me/2000/XP. installation will auto run.
3. Click the setup. exe file to execute file set-up.
4. Follow on screen instructions to complete installation.

E

To install USB Driver for Windows 98

- 1.Insert the installation CD into your computer CD-ROM driver.
- 2.Open the file of "windows 98 USB Driver ", It requires a manual install.
- 3.select the item of "Add New Hardware" from "control panel" to install USB Driver to your computer.
- 4.Use instructions on page28 to page37 to install the driver.

Warning: This driver is not needed under Windows ME/NT/2000/XP system as the Digital Camera supports mass storage driver system. Do not install this driver into your computer if the operation system is not Windows98. Improper installation may destory your computer.

Operation:

1.Install way:Follow on-screen of your computer,click:

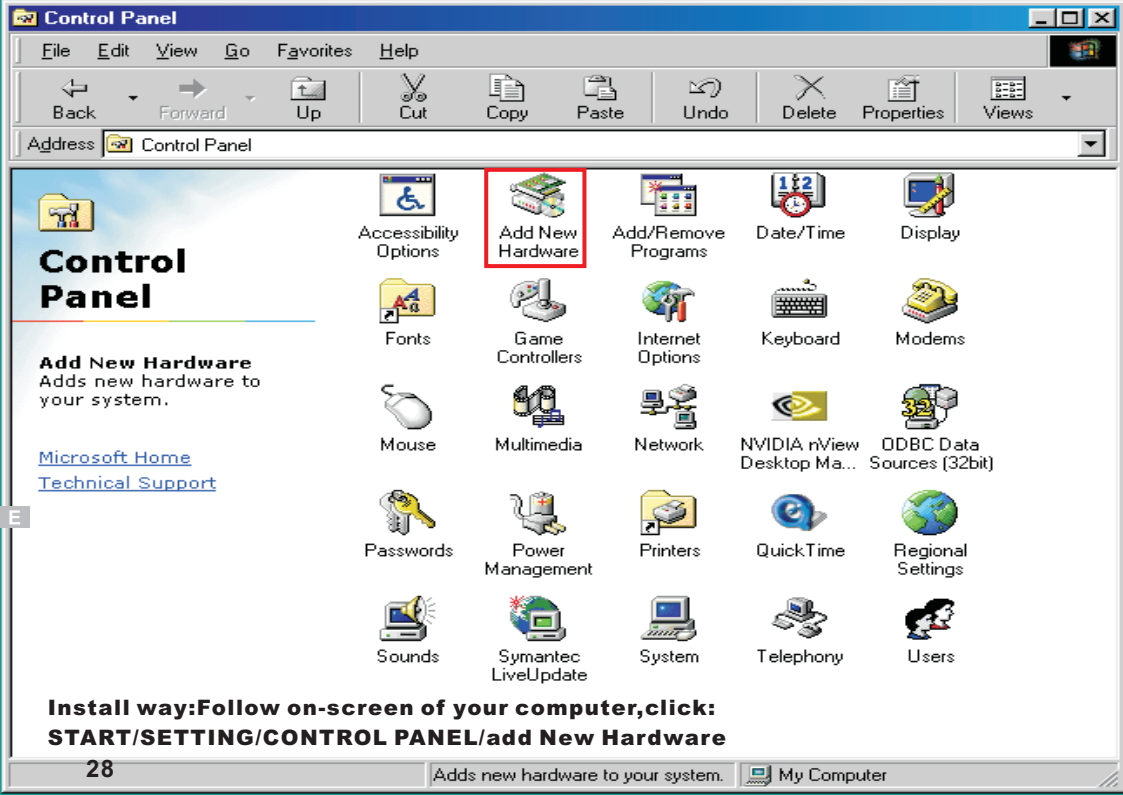

- 1.START/SETTING/CONTROL PANEL/Add New Hardware**
- 2.Screen display the driver file name automatically.Then click **Next****
- 3.Select the driver Search .Then click **Next****
- 4.Select locations of data source.Then click **Next****
- 5.Screen display to confirm the driver location .Then click **Next****
- 6.Follow on-screen instructions to complete installation .**
Screen display windows has finished installing.Then click **Finish**
- 7.Screen display a **removable Disk** appear .Then click it.**
- 8.A **new file** appear.**
- 9.Click the **file**.**
- 10.Click the **file** to playback picture.**



Control Panel

Add New Hardware
Adds new hardware to your system.

[Microsoft Home](#)
[Technical Support](#)

| | | | | |
|--|--|--|--|--|
|  Accessibility Options |  Add New Hardware |  Add/Remove Programs |  Date/Time |  Display |
|  Fonts |  Game Controllers |  Internet Options |  Keyboard |  Modems |
|  Mouse |  Multimedia |  Network |  NVIDIA nView Desktop Ma... |  ODBC Data Sources (32bit) |
|  Passwords |  Power Management |  Printers |  QuickTime |  Regional Settings |
|  Sounds |  Symantec LiveUpdate |  System |  Telephony |  Users |

Install way: Follow on-screen of your computer, click: START/SETTING/CONTROL PANEL/add New Hardware

This wizard searches for new drivers for:

DSC-100A

A device driver is a software program that makes a hardware device work.



Note: Screen display the driver file name automatically.

Then click Next

< Back

Next >

Cancel



What do you want Windows to do?

- Search for the best driver for your device.
(Recommended).
- Display a list of all the drivers in a specific location, so you can select the driver you want.

Note: Select the driver Search .

Then click Next

< Back

Next >

Cancel



Windows will search for new drivers in its driver database on your hard drive, and in any of the following selected locations. Click Next to start the search.

- Floppy disk drives
- CD-ROM drive
- Microsoft Windows Update
- Specify a location:

D:\WIN98

Browse...

Note: Select locations of data source.

Then click Next

< Back

Next >

Cancel



Windows driver file search for the device:

Digital Camera Zoom

Windows is now ready to install the best driver for this device. Click Back to select a different driver, or click Next to continue.

Location of driver:

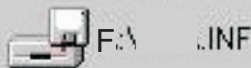

Note: Screen display to confirm the driver location.

Then click Next

< Back

Next >

Cancel



Digital Camera Zoom

Windows has finished installing the software that your new hardware device requires.



Note: Follow on-screen instructions to complete installation .

Screen display windows has finished installing.

Then click **Finish**

< Back

Finish

Cancel

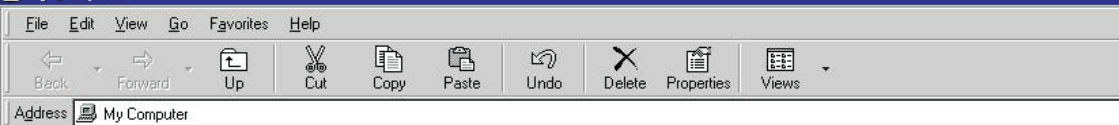

My Computer

Capacity: 62.3 MB

Used: 1.82 MB

Free: 60.5 MB



3½ Floppy (A:) Programme (C:) Win98_en (D:) File data (E:) Win2000_en (F:) Win98_engl... (G:) Removable Disk (H:)

Dial-Up Networking Scheduled Tasks Web Folders

**Note: Screen display a removable Disk appear .
Then click it.**

File Edit View Go Favorites Help



Back



Forward



Up



Cut



Copy



Paste



Undo



Delete

Address  H:\



Removable Disk (H:)



Select an item to view its description.

Note: A new file appear.

File Edit View Go Favorites Help



Back



Forward



Up



Cut



Copy



Paste



Undo



Delete

Address  H:\**Dcim**

Select an item to view its description.

Note: Click the file.

101_

File Edit View Go Favorites Help

Back Forward Up Cut Copy Paste Undo Delete Properties Views

Address E:\



101_



Dcp_0008.jpg
JPEG Image

Modified:
1/1/01 2:35 PM

Size: 332KB



Note: Click the file to playback picture.

To install MGI Photo Suite8.21SE software

1. Insert the installation CD into your computer CD-ROM driver.
2. Open the file of "MGI Photo Suite8.21SE, program should install automatically. It's still picture edit Album.
3. Follow on-screen instructions to complete installation.
4. Use instruction on page39 to page55.

Operation:

1. Follow on-screen of your computer, first, select language : Then click **OK**
2. The set up process automatically, please wait.
3. The software recommended that exit all Windows programs If ready, click **Next**
4. Display the LICENSE AND WARRANTY information. If you agree, click **Yes**
5. Please select the image file type(s) that you wish associate then click **Next**
6. Choose the file destination location. Browse the folder , then click **Next**
7. Select folder name, Accessories ? or new? then click **Next**
8. Display Current setting automatically. then click **Next**
9. Display Online Registration automatically. then click **Continue**
10. Follow on-screen instructions to complete installation .
Screen display windows has finished installing. Then click **Finish**
11. Program way: click: **Start / Programs / MGI PhotoSuite8.21SE / MGI PhotoSuite8.21SE.exe** otherwise click **quick mark**.
12. Select a picture and edit . Use instructions on QSG (Quick Start Guide)



Select the language for this installation from the choices below.

English (United States)



OK

Cancel

E



PhotoSuite™

Version 8.21 SE



Copyright © 1998 MGI Software Corp.
All Rights Reserved.

Note: The set up process automatically, please wait.

Setup



MGI PhotoSuite 8.21 Setup is preparing the InstallShield® Wizard which will guide you through the rest of the setup process. Please wait.

100 %



Welcome to the MGI PhotoSuite **8.21** Setup program.
This program will install MGI PhotoSuite **8.21** on your computer.

It is strongly recommended that you exit all Windows programs before running this Setup program.

Click Cancel to quit Setup and then close any programs you have running. Click Next to continue with the Setup program.

WARNING: This program is protected by copyright law and international treaties.

Unauthorized reproduction or distribution of this program, or any portion of it, may result in severe civil and criminal penalties, and will be prosecuted to the maximum extent possible under law.

Note: The software recommends that you exit all Windows programs
If you are ready, click **Next**



Please read the following License Agreement. Press the PAGE DOWN key to see the rest of the agreement.

NOTICE: MGI SOFTWARE CORP. (MGI) LICENSES THE ENCLOSED SOFTWARE TO YOU ONLY UPON THE CONDITION THAT YOU ACCEPT ALL OF THE TERMS CONTAINED IN THIS LICENSE AGREEMENT. PLEASE READ THE TERMS CAREFULLY. IF YOU DO NOT AGREE TO THESE TERMS, THEN MGI IS UNWILLING TO LICENSE THE SOFTWARE TO YOU, IN WHICH EVENT YOU SHOULD RETURN THE FULL PRODUCT WITH PROOF OF PURCHASE TO THE DEALER FROM WHOM IT WAS ACQUIRED WITHIN SIXTY DAYS OF PURCHASE, AND YOUR MONEY WILL BE REFUNDED.

LICENSE AND WARRANTY:

The software which accompanies this license (the "software") is the property of MGI or its licensors and is protected by copyright law. While MGI continues to own the Software,

Do you accept all the terms of the preceding License Agreement? If you choose No, Setup will close. To install MGI PhotoSuite[®] 8.21, you must accept this agreement.

Note: Display the LICENSE AND WARRANTY information.

If you agree, click **Yes**

< Back

Yes

No



Please select the image file type(s) that you wish to associate with PhotoSuite 8.21SE

- Windows Bitmap (*.bmp)
- Targa Image (*.tga)
- CompuServe Image (*.gif)
- PCC Paintbrush (*.pcx)
- Kodak PhotoCD (*.pcd)
- TIFF (*.tif, *.tiff)
- JPEG Image (*.jpg, *.jpe, *.jpeg, *.jpa)
- FFX Format (*.fpx)
- Others (*.pic, *.sfw, *.kqp)

Note: Please select the image file type(s) that you wish associate then click **Next**

< Back

Next >

Cancel



Setup will install MGI PhotoSuite8.21 in the following folder.

To install to this folder, click Next.

To install to a different folder, click Browse and select another folder.

You can choose not to install MGI PhotoSuite8.21 by clicking Cancel to exit Setup.

Destination Folder

C:\Program Files\MGI\PhotoSuite8.21SE

Browse...

Note: Choose the file destination location.

Browse the destination folder, then click Next

< Back

Next >

Cancel



Setup will add program icons to the Program Folder listed below. You may type a new folder name, or select one from the existing Folders list. Click Next to continue.

Program Folders:

MGI PhotoSuite 8.21 SE

Existing Folders:

Accessories
Avance Sound Manager
Online Services
StartUp

**Note: select folder name, Accessories ? or new?
then click Next**

< Back

Next >

Cancel

Setup has enough information to start copying the program files. If you want to review or change any settings, click Back. If you are satisfied with the settings, click Next to begin copying files.

Current Settings:

Target directory:
D:\Program Files\MGI\PhotoSuite 8.21

Program group name:
MGI PhotoSuite 8.21

Components to install:
MGI PhotoSuite
Read Me
MGI Direct Print
MGI Image Information
MGI Diskette Label Tool

8.21SE



Note: display Current setting automatically..
then click **Next**

< Back

Next >

Cancel



Thank you for taking the time to register your MGI product. Registered users enjoy many exclusive benefits, including:

- Priority technical support.
- The latest news about our products including free updates.
- Special offers, promotions and contests.

**Note: display Online Registration automatically.
then click Continue**

Continue

Online Registration Utility

| | | |
|---|--|---|
| <input type="checkbox"/> <u>M</u> r/ <u>M</u> rs/ <u>M</u> ss/ <u>M</u> s/ <u>D</u> r | <input type="checkbox"/> <u>F</u> irst name: | <input type="checkbox"/> <u>S</u> urname: |
| <input type="text"/> | <input type="text"/> | <input type="text"/> |
| <input type="checkbox"/> <u>E</u> -mail address: | <input type="checkbox"/> <u>C</u> ountry: | <input type="text"/> |
| <input type="text"/> | <input type="text"/> | <input type="text"/> |
| <u>C</u> ompany: | <u>P</u> rovince/ <u>S</u> tate/ <u>R</u> egion: | <input type="text"/> |
| <input type="text"/> | <input type="text"/> | <input type="text"/> |
| <u>A</u> ddress1: | <input type="text"/> | <u>C</u> ity: <input type="text"/> |
| <u>A</u> ddress2: | <input type="text"/> | <u>Z</u> ip: <input type="text"/> |
| <u>P</u> hone: <input type="text"/> | <u>F</u> AX: <input type="text"/> | |

Required.

- Provide me with news about MGI Software product updates and promotional events.
- Provide me with information from MGI approved partners.
- I don't have an e-mail address yet.

Your privacy is important! The information you provide helps us to serve you. It will be held in the strictest confidence and will not be sold, rented or shared without your consent.



Setup has finished installing MGI PhotoSuite 8.21 on your system.

The following actions are now available.
Check the ones you want to perform.

YES, I want to see the Read Me file now

Click Finish to complete Setup.

Note: Follow on-screen instructions to complete installation .

Screen display windows has finished installing. Then click Finish

< Back

Finish

Windows Update

Programs

Favorites

Documents

Settings

Find

Help

Run...

Log Off Lqf...

Shut Down...

Windows 9

- Accessories
- Avance Sound Manager
- Online Services
- StartUp
- Internet Explorer
- MS-DOS Prompt
- Outlook Express
- Windows Explorer

- MGI PhotoSuite 8.21SE
- MGI Direct Print
- MGI Diskette Label Tool
- MGI Photo Renaming Tool
- MGI PhotoSuite 8.21SE
- Read Me

**Note:..Program way:click: Start /Programs/
MGI PhotoSuite8.21SE/MGI PhotoSuite8.21SE.exe
or click quick mark.**

Start



Get Photos



Edit or Enhance
Photos



View an Album



View a Slideshow



Print Your Photos



Create a Sports Card

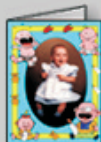

Create a Greeting
Card



Create a Calendar
or Poster



Create a Magazine
Cover



Fun with your
Photos

Show Activity Guide on Startup



Hard Disk/Memory Stick



Floppy Disk



PhotoCD or Picture CD or
FlashPix CD



Scanner



Digital Camera (TWAIN)



Add Images to Album

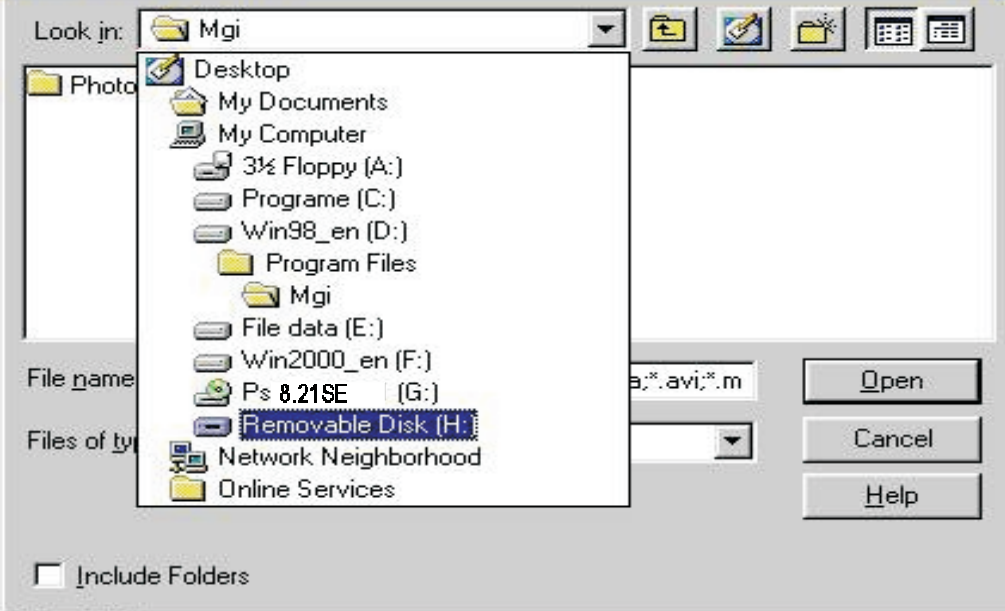

Add Images to Album



Look in: 10

| | | | |
|----------|----------|----------|----------|
| 3 | Dcp_0006 | Dcp_0014 | Dcp_0020 |
| Dcp_0001 | Dcp_0007 | Dcp_0015 | Dcp_0021 |
| Dcp_0002 | Dcp_0008 | Dcp_0016 | Dcp_0022 |
| Dcp_0003 | Dcp_0009 | Dcp_0017 | Dcp_0023 |
| Dcp_0004 | Dcp_0010 | Dcp_0018 | Dcp_0024 |
| Dcp_0005 | Dcp_0013 | Dcp_0019 | Dcp_0025 |

File name: Dcp_0004

Open

Files of type: All Files

Cancel

Help

 Include Folders



<Untitled Album>



To install Quick Time5 software

- 1.Insert the installation CD into your computer CD-ROM driver.
- 2.Open the file of "Quick Time5", program should install automatically.It's video Streaming movie playback Album.
- 3.Follow on-screen instructions to complete installation.
- 4.Use instruction on page57 to page76.
- 5.The ID number was:QTFileFormat NO.ID#SWL70337
Software Distribution Agreement NO.ID#SWL70338

OPERATION:

- 1.The instruction of Location .Installation. Update then click **Next**
- 2.The software recommended that exit all Windows programs If ready, click **Next**
- 3.Display the LICENSE AND WARRANTY information. If you agree, click **Agree**
- 4.Choose the file destination location. Browse the folder ,then click **Next**
- 5.Please select the image file type(s) that you wish associate .then click **Next**
- 6.Select folder name, Accessories ? or new? then click **Next**
- 7.Selection of Plugin . then click **Next**
- 8.The set up process automatically,please wait.
- 9.The instruction of Setup Assistant, then click **Next**
- 10.The MIME Setting ,then click **Next**
- 11.Select the file type association , then click **Next**
- 12.Follow on-screen instructions to complete installation .
Screen display windows has finished installing.Then click **Finish**
- 13.Program way:click: **Start/Programs/Quick Time/Quick Time player**. otherwise click **quick mark**.
- 14.Select a picture and edit .Use instructions on QSG(Quick Start Guide)



Use QuickTime Software for Movie Playback

It's strongly recommended to use QuickTime software for Movie Playback operation , You can free down load and allow you to install it use one copy on a single computer at a time, not sold.

"Quick Time" Player is a FREE premier multimedia player. It is a stylish and unique powerhouse media authoring. You can create MPEG-2 content, play movies in full screen, edit movies with the simplicity of cut, copy and paste.

The system requirements: at least 32Mb of RAM
Mac OS 8.6 OS X v1.0 or later
Window 98/Me/2000/XP



Quick Time Player features: defined by Moving Picture Experts Group
playback MPEG-2 MPEG-4 video,
Easy-to-use controls, streaming media support.
QuickTime provide superior performance for both precision and speed ,and a High-quantizer.

Visit www.apple.com/quicktime to see a comprehensive guide.
Email quicktime@apple.com to contacting Apple.

QuickTime , including QuickTime Player, Picture Viewer, browser plug-ins, QuickTime Streaming Server , Darwin Streaming Server and QuickTime Broadcaster are free, with no per-stream licensing fees.

QuickTime Pro is an upgrade to QuickTime need fee \$30.
QuickTime 6 MPEG-2 Playback Component is available for \$20.

Apple ensure backward compatibility with QuickTime 1 still QuickTime 6.



QuickTime™

Welcome to QuickTime 5

QuickTime 5 enables your computer to handle video, graphics, music, sound, sprites, text, VR panoramas, animation, and content streamed over the Internet.

This installer lets you choose the QuickTime software you want, and places it in the appropriate locations on your computer. For future installations use the QuickTime Updater installed in your QuickTime folder.

Note: The instruction of Location .Installation. Update
then click **Next**

< Back

Next >

Cancel

Welcome to the QuickTime 5 Setup program. This program will install QuickTime 5 on your computer.

It is strongly recommended that you exit all Windows programs before running this Setup program.

Click Cancel to quit Setup and then close any programs you have running. Click Next to continue with the Setup program.

WARNING: This program is protected by copyright law and international treaties.

Unauthorized reproduction or distribution of this program, or any portion of it, may result in severe civil and criminal penalties, and will be prosecuted to the maximum extent possible under law.

Note: The software recommends that you exit all Windows programs. If ready, click **Next**

< Back

Next >

Cancel

Please read the following License Agreement. Press the PAGE DOWN key to see the rest of the agreement.



English

Apple Computer, Inc.
Software License Agreement
Single Use License

PLEASE READ THIS SOFTWARE LICENSE AGREEMENT ("LICENSE") CAREFULLY BEFORE PRESSING THE "AGREE" BUTTON. BY PRESSING "AGREE," YOU ARE AGREEING TO BE BOUND BY THE TERMS OF THIS LICENSE. IF YOU DO NOT AGREE TO THE TERMS OF THIS LICENSE, PRESS "DISAGREE" AND (IF APPLICABLE) RETURN THE APPLE SOFTWARE TO THE PLACE WHERE YOU OBTAINED IT FOR A REFUND.

1. General. The software, documentation and any fonts accompanying

Note: Display the LICENSE AND WARRANTY information.

If you agree, click **Agree**

English

Print

< Back

Agree

Disagree

Setup will install QuickTime 5 in the following directory.

To install to this directory, click Next.

To install to a different directory, click Browse and select another directory.

You can choose not to install QuickTime 5, by clicking Cancel to exit Setup.



QuickTime™

Destination Directory

C:\Program Files\QuickTime

Browse...

Space Required: 7936 K

Space Available: 9468544 K

Note: Choose the file destination location.

Browse the folder, then click **Next**

< Back

Next >

Cancel

 **Minimum**

Enables playback of most audio and video formats.

 Recommended

Suggested for QuickTime Pro users and media creators.

 Custom

Select to perform custom installation.

Recommended

Approximate download size: 7.2 MB

Installs the Minimum package, PictureViewer, authoring support, DV support, and media exporters.

Note: Please select the image file type(s) that you wish associate then click **Next**

< Back

Next >

Cancel

Setup will add program icons to the Program Folder listed below. You may type a new folder name, or select one from the Existing Folders list. Click Next to continue.

Program Folder:

Existing Folders:

- Accessories
- Avance Sound Manager
- MGI PhotoSuite 8.21SE
- Norton AntiVirus Corporate Edition
- Online Services
- StartUp
- WinZip

Note: Select folder name, Accessories ? or new? then click **Next**



Setup will install the QuickTime Plugin for Web Browsers into the following directories.

To install into these directories, click Next.

To install into a different directory, click Browse and select another directory.

You can choose not to install the QuickTime Plugin by clicking Cancel to exit Setup.

Netscape Navigator or Communicator

Browse...

Microsoft Internet Explorer

C:\program files\internet explorer\plugins

Browse...

Note: Selection of Plugin . then click **Next.**

< Back

Next >

Cancel

Copying file:

D:\WINDOWS\SYSTEM\QuickTimeMusicalInstruments.qtx

Note:The set up process automatically,please wait.

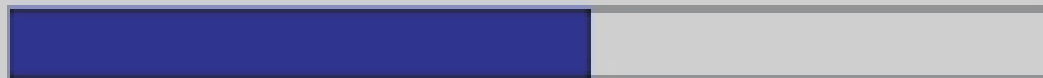

Cancel

This installation was created with Installer VISE
from MindVision Software
<http://www.mindvision.com>

Introduction

Welcome to the QuickTime Setup Assistant!

This assistant allows you to configure some basic settings for QuickTime. These settings allow you to get the most out of your QuickTime software.

If you want to change any of these settings in the future, use the QuickTime control panel.

Note: The instruction of Setup Assistant, then click **Next**

Previous

Next 67

Browser Plug-in

QuickTime will now configure your Web browser so that movies will be displayed using the QuickTime browser plug-in.

To view or customize the details of this MIME type configuration, press the MIME Settings button below.

Note: The MIME Setting , then click **Next**

MIME Settings...

File Type Associations

You can associate multimedia file types with QuickTime viewers.

Select viewer associations:

- Windows file types
(AVI, BMP, ...)
- Macintosh file types
(PICT, AIFF, ...)
- Internet file types
(GIF, JPEG, ...)

- Notify me if other applications modify these viewer associations.

Note: Select the file type association, then click **Next**

Previous

Finish



QuickTime™

QuickTime Setup is now complete. You can view the README file or launch QuickTime Player now. Please choose the options you want below.

- Yes, I want to view the QuickTime README file.

- Yes, I want to launch QuickTime Player.

Click Close to complete QuickTime Setup.

Note: Follow on-screen instructions to complete installation .
Screen display windows has finished installing. Then click **Finish**

< Back

Close

Cancel

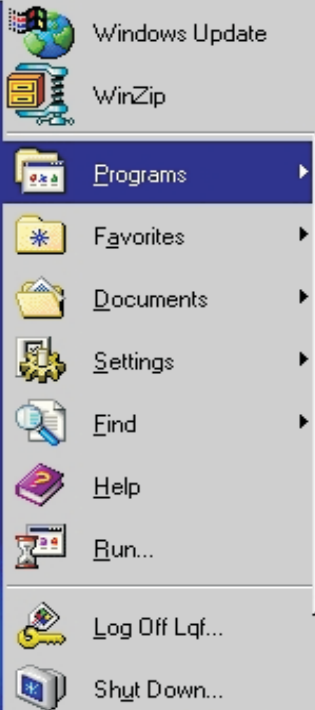

Windows 98 Start menu items:

- Windows Update
- WinZip
- Programs
- Favorites
- Documents
- Settings
- Find
- Help
- Run...
- Log Off Lqf...
- Shut Down...

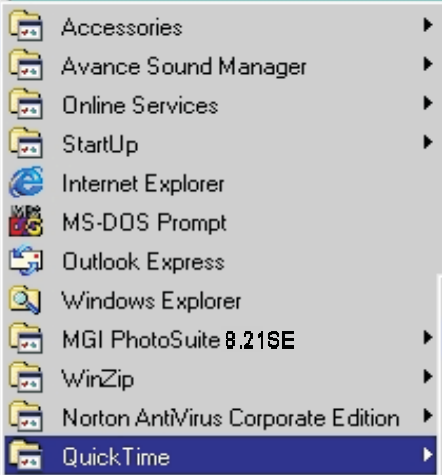

Start menu Programs list:

- Accessories
- Avance Sound Manager
- Online Services
- StartUp
- Internet Explorer
- MS-DOS Prompt
- Outlook Express
- Windows Explorer
- MGI PhotoSuite 8.21SE
- WinZip
- Norton AntiVirus Corporate Edition
- QuickTime

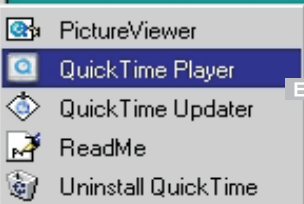

QuickTime submenu items:

- PictureViewer
- QuickTime Player
- QuickTime Updater
- ReadMe
- Uninstall QuickTime

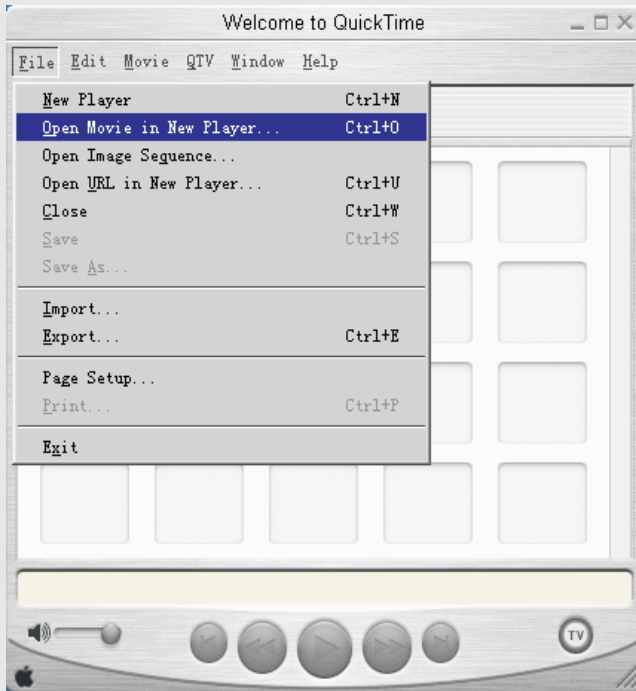

E

Look in: Quicktime

Preview



File name

Files of type

- Desktop
- My Documents
- My Computer
- 3½ Floppy (A:)
- Program (C:)
- Win98_en (D:)
 - Program Files
 - Quicktime
- File data (E:)
- Win2000_en (F:)
- (G:)
- Removable Disk (H:)
- Network Neighborhood
- Online Services



Open

Cancel

Create

 Show Preview

Look in:  101_ 

Preview

File name: Files of type:  Show Preview

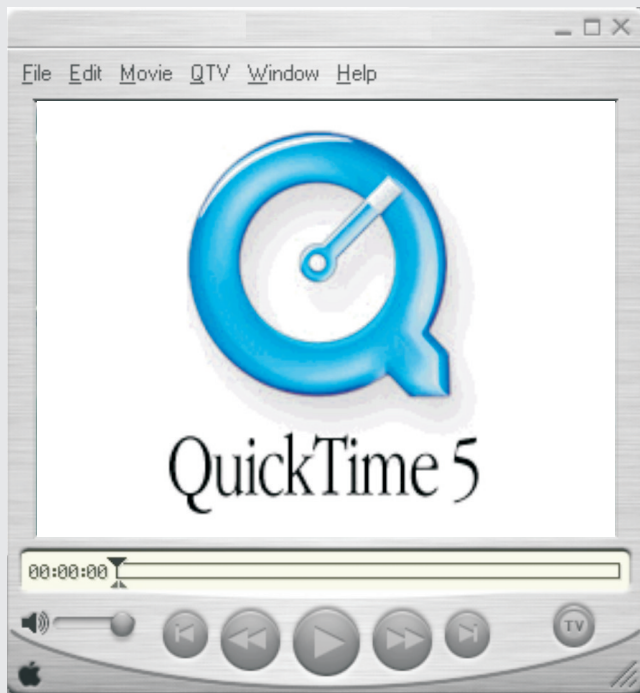

E

FAQ (FREQUENTLY ASKED QUESTIONS)

The software will display the following messages after performing system detection with DSC in various operation modes

| NO. | On-screen Message | Description of On-screen Message | Time Point of Software detection | Action Response after detection | Possible Reasons |
|-----|-----------------------------------|---|----------------------------------|--|---|
| 1 | SRAM ERROR | | Detect when starting up | Shut down in a few seconds | SRAM fails to read data |
| 2 | TIMER NOT TICK | TIMER does not work | Detect when starting up | ERROR Warning displays when it is set up | REAL TIME system failure |
| 3 | EEPROM ERROR | | Detect when starting up | Shut down in a few seconds | EEPROM read/write failure |
| 4 | MEDIA NOT SUPPORT | Media is not supported | Detect when starting up | Key failure | CF CARD over 256M is not supported |
| 5 | FORMAT REQUIRE GO TO SETTING MODE | | Detect when starting up | Key failure | CF CARD over 32M is required to FORMAT |
| 6 | WRITE PROTECT | Write function is protected | Detect when deleting | Delete action failure | Protected files can not be deleted; You must set up Release PROTECT firstly |
| 7 | LENS INIT ERROR | The initial value of Lens is not set up correctly | Detect when starting up | Key failure | The initial value of lens had not been defined in the software |
| 8 | COMPRESS REEOR | Data is not compressed correctly | Detect when fetching data | Compress action failure | Compress data failure; Please reset it. |
| 9 | NO CARD | CF card is not inserted | Detect when starting up | Key failure when reading data | CF CARD is not inserted |
| 10 | MEDIA ERROR | Media failure | Detect when starting up | Key failure | CF CARD Failure |

FAQ (FREQUENTLY ASKED QUESTIONS)

The software will display the following messages after performing system detection with DSC in various operation modes

| NO. | On-screen Message | Description of On-screen Message | Time Point of Software detection | Action Response after detection | Possible Reasons |
|-----|-------------------|---------------------------------------|--------------------------------------|--|--|
| 11 | DECOMPRESS ERROR | Decompress failure | Detect when reading data | Decompress data failure | Decompress failure |
| 12 | NO FILE | No file | Detect when reading data | Key failure | No picture file is in the memory |
| 13 | FILE DELETE ERROR | File can not be deleted | Detect when deleting data | Key failure | Failure when deleting picture file |
| 14 | HEADER ERROR | Initial file is not handled correctly | Detect when reading data | Fails to unfold files | File unfold failure |
| 15 | MEDIA READ ERROR | Media fails to read data | Detect when reading data | Key failure | File unfold failure |
| 16 | AVI READ ERROR | Fails to read animation | Detect when reading data | Fails to extract data | Files in a AVI mode fails to read |
| 17 | FORMAT ERROR | Memory card fails to format | Detect when formatting | Format failure | Format memory card failure |
| 18 | SYSTEM ERROR | System failure | Memory self-test | Shut down in a few seconds automatically | Memory address error |
| 19 | STROBE ERROR | Strobe light failure | Detect when strobe light is charging | No flash or flash is out of control | Strobe light charge failure |
| 20 | MEMORY FULL | Memory full | Detect when storing data | Fails to store data | Short of memory space or space is full |

Specifications

- CCD : 1/2.7" 2.11megapixel CCD delivering image resolutions as high as 1672 X 1248 pixels
- Storage mode : Still picture : JPEG file
Movie picture : AVI compatible
- Storable cards : CF card (8MB 16MB 32MB 48MB
64MB 96MB 128MB 192MB) option
CF cards are available in many different capacities
- Number of storable pixels : L: 1672 X 1248 pixels (HQ\SQ)
S: 640 X 480 pixels (HQ\SQ)
- Compression ratio : HQ : 1/8
SQ : 1/16
- Number of storable pictures : 16: HQL
32: SQL
100: HQS
200: SQS
based on 8MB memory
- Lens : 1) Continuous 3xZoom
2) TTL auto-focus f5.4 ~ 16.2mm
(equivalent to 35 ~ 105mm)
8 elements in 3 groups (2 Aspherical lens)
- Digital zoom : 2x digital zoom

| | |
|--------------------|---|
| Shooting distance | : 0.66' (0.2m) ~ 1.64' (0.5m) in Macro mode 1.64' (0.5m) ~ ∞ in standard mode |
| Exposure metering | : Multi-metering (64-segment Matrix) |
| Optical viewfinder | : real-image zoom viewfinder diopter adjustment -2.0~+1DP (visual range unit) |
| LCD monitor | : 1.8" TFD brightness adjustment approx. 60000 pixels |
| Storage file | : DCF standard |
| Shooting modes | : Auto |
| Movie display mode | : 12sec for QVGA, 320 X 240 pixels at 15fps |
| Shutter | : 1) 1/2~1/500 sec, mechanical and electronic shutter 2) Aperture Wide F2.8, F8/Tele F4.6, F13.6 |
| Exposure control | : Programmed auto and manual compensation ±2EV in 1/3EV steps (approx. -6/3EV~+6/3EV) |
| White balance | : 1) Auto 2) Manual in Sunny Cloudy Indoor Fluor |
| Self-timer | : 10sec duration |
| Power on time | : Approx. 5sec |
| LED | : 1) Self-timer LED (red) 2) Shooting ready (green) 3) AF ready (orange) |

| | |
|----------------------------|--|
| Flash | : Flash mode 1) Auto 2) Red-eye reduction 3) Fill-in 4) Off 5) Night scene Sensor control, Gno. 10.5 |
| OSD-On Screen Display | : English German French |
| Protect modes | : One, All |
| Date/Time | : Year / Month / Day / Hour / Minute |
| PC interface | : USB (Ver1.1 MassStorage) |
| PC driver | : Windows: 98/ME/2000/XP |
| Power requirements | : Use 4 AA 1.5V batteries and similar (option) Professional AC adapter (option) |
| Image playback on TV | : NTSC |
| External adapter | : Computer adapter, TV adapter, AC adapter(option) |
| Continuous shooting | : Over 100 pictures |
| Environmental requirements | : Temperature : 0 °C ~ 40 °C (operation) -20 °C ~ 60 °C (storage) Humidity : 10 ~ 90% (operation) |
| Dimensions (W X H X D) | : 110 X 70 X 45mm |
| Weight (without battery) | : 245g |

DC 3550 Quick Start Guide

Battery Installation

1. Open battery chamber cover.
2. Insert 4 batteries into the battery chamber. Be sure to use correct polarity as shown on the battery chamber inside cover.
3. Close battery chamber cover.

Compact Flash Card Installation

1. Open the CF card slot.
2. Insert the CF card into the slot. Be sure that the CF card is in the upright position.
3. Close the CF card slot.

Powering Up

1. Turn the power on by sliding the POWER button following the arrows.
2. Turn the MODE dial to .
3. You are ready to take photographs.

Taking Photos

1. Compose the image in the viewfinder or LCD Monitor Display.
2. Press the Shutter Button down halfway to lock the focus.
3. After the focus is locked continue pressing the Shutter Button to take the picture.

LCD Modes

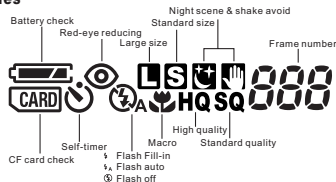

To find out more information on how to:

Use LCD Modes, see page 11-12 in the User's Manual.

Setting Picture Display

Press MENU button to set the display mode.

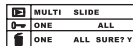

For more information on how to:

Use Multi Frames Mode, see page 20-21 in the User's Manual
Use Slide Modes, see page 20-21 in the User's Manual
Enlarging the picture display, see page 20 in the User's Manual

DC3550 Nomenclature

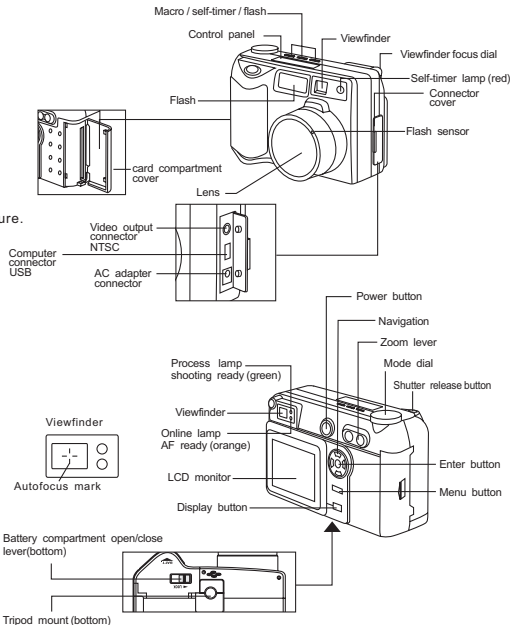

QUICK GUIDE DC3550

Accessories- Album STI Protocol Image Process & Video Streaming

A. USB DRIVER INSTALLATION UNDER WINDOWS98 OPERATION SYSTEM

Warning: This driver is not needed under Windows ME/NT/2000/XP system as the Digital Camera supports mass storage driver system. Do not install this driver into your computer if the operation system is not Windows98. Improper installation may destroy your computer.



B. MGI PhotoSuite INSTALLATION



Installation procedure:

- Choose Setup language
- Select image file type
- Choose Destination Location
- Online Registration

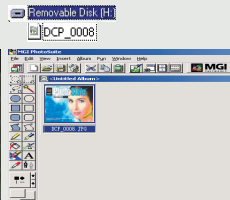

C. QuickTime 5 INSTALLATION:

Installation procedure:

- Choose Setup Language
- Choose Destination Location
- Choose Install Type
- Configure & File Type Association

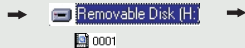
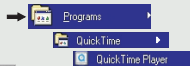

MGI PHOTO SUITE 8.21SE MENU QUICK GUIDE

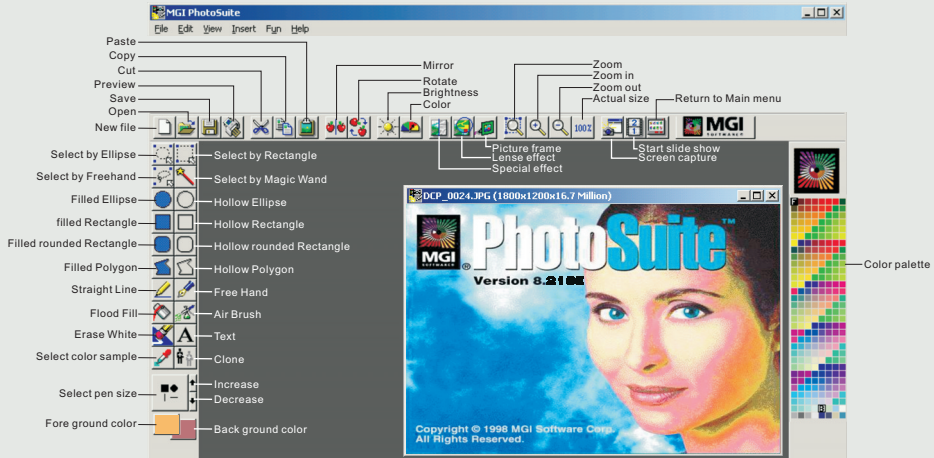
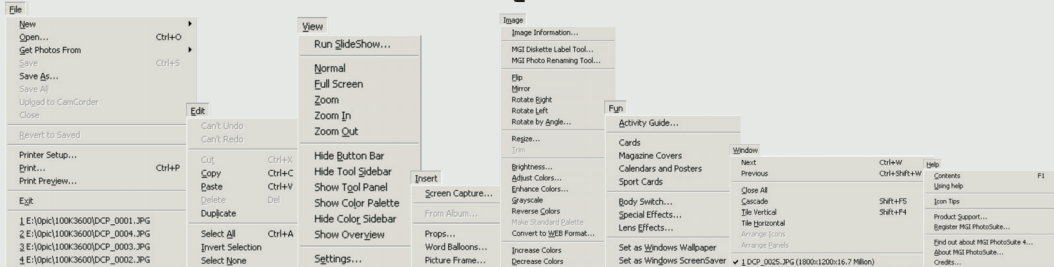

QUICKTIME5 MENU QUICK GUIDE

| File | |
|-----------------------------|--------|
| New Player | Ctrl+N |
| Open Movie in New Player... | Ctrl+O |
| Open Image Sequence... | |
| Open URL in New Player... | Ctrl+U |
| Close | Ctrl+W |
| Save | Ctrl+S |
| Save As... | |
| Import... | |
| Export... | Ctrl+E |
| Page Setup... | |
| Print... | Ctrl+P |
| Exit | |

| Edit | |
|-------------------|--------|
| Undo | Ctrl+Z |
| Cut | Ctrl+X |
| Copy | Ctrl+C |
| Paste | Ctrl+V |
| Clear | Del |
| Select All | Ctrl+A |
| Select None | Ctrl+B |
| Add | |
| Add Scaled | |
| Replace | |
| Trim | |
| Enable Tracks... | |
| Extract Tracks... | |
| Delete Tracks... | |
| Find... | Ctrl+F |
| Find Again | Ctrl+G |
| Preferences | |

| Movie | |
|----------------------|--------|
| Loop | Ctrl+L |
| Loop Back and Forth | |
| Half Size | Ctrl+O |
| Normal Size | Ctrl+I |
| Double Size | Ctrl+2 |
| Fill Screen | Ctrl+3 |
| Present Movie... | Ctrl+W |
| Show Sound Controls | |
| Show Video Controls | Ctrl+K |
| Get Movie Properties | Ctrl+J |
| Play Selection Only | Ctrl+T |
| Play All Frames | |
| Play All Movies | |
| Go To Poster Frame | |
| Get Poster Frame | |
| Choose Language... | |

| QTV | |
|--------------|--|
| QuickTime TV | |
| Favorites | |

| Window | |
|--------------------------|--------|
| Show Movie Info | Ctrl+I |
| Welcome to QuickTime (1) | |

| Help | |
|-------------------------------|--|
| On-line QuickTime Player Help | |
| Update Existing Software... | |
| QuickTime Web Site | |
| About QuickTime Player... | |

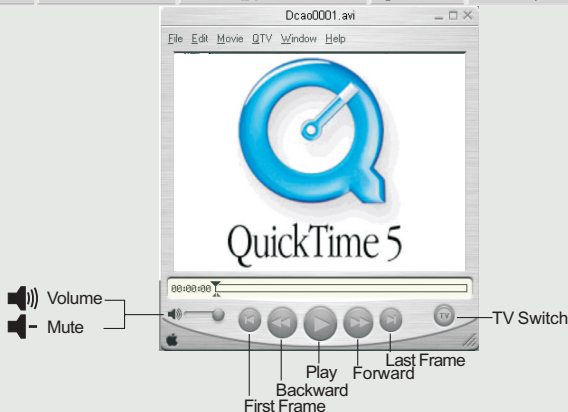

FC This camera is tested to comply with FCC standards for home and office use.

CE This camera complies with EU directives for CE marking.