

LCD Digital Camera User's Guide

Before using this camera, be sure to read the precautions contained in this User's Guide, and keep it in a safe place for future reference.

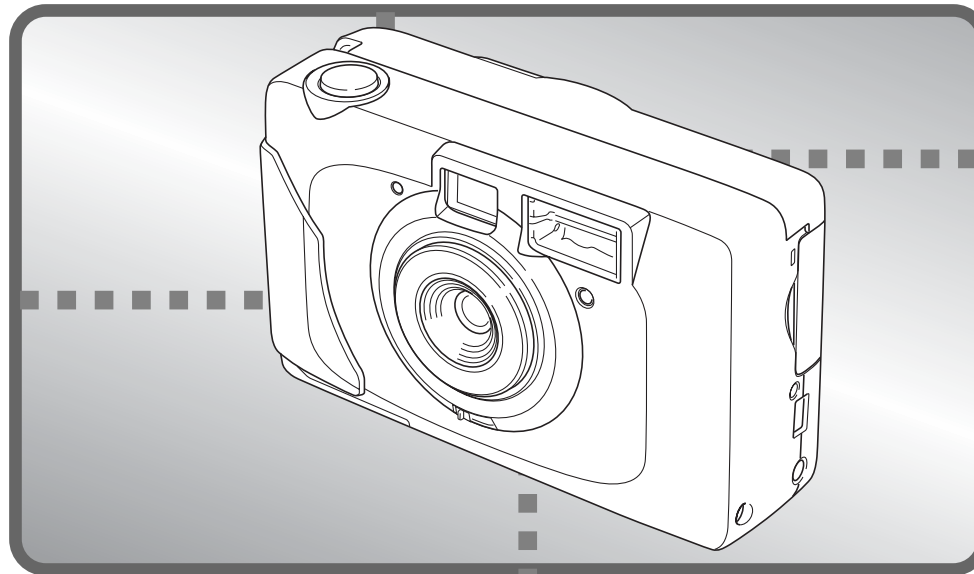

E

INTRODUCTION

Unpacking

Check to make sure that all of the items shown below are included with your camera. If something is missing, contact your dealer as soon as possible.

Camera

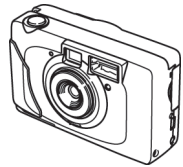

Soft case



Strap



CD-ROM

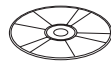

Alkaline batteries
(4 AA-size batteries)

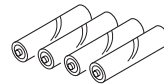

User's Guide

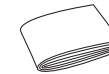

USB cable

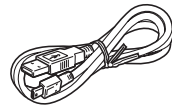

Special video cable



Installation Guide

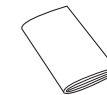

Contents

2 INTRODUCTION

- Unpacking 2
- Features 6
- Precautions 7
 - General Precautions 7
 - Data Error Precautions 8
 - Operating conditions 8
 - Condensation 9
 - About the camera's backlight 9
 - Lens Precautions 9

11 GETTING ACQUAINTED

- General Guide 11
 - Front 11
 - Back 12
 - Side 13
 - Bottom 13
- Monitor Screen Indicators 14
 - REC mode 14
 - PLAY mode 15
- Indicator Lamps 15

- Using the Bundled Accessories 16
 - Using the Lens Cap 16
 - Attaching the Strap 16
 - Using the Soft Case 17
- Power Requirements 17
 - Loading Batteries 18
 - Battery Handling Precautions 20
 - Low Battery Indicator 21
 - Using AC Power 22
 - Turning the Camera On and Off 23
 - Power Save Settings 24
- Setting the Current Date and Time 24
 - Setting the Date and Time 25

27 RECORDING IMAGES

- Recording a Simple Snapshot 27
 - About the REC Mode Monitor Screen 29
 - Recording Precautions 29
- Using Zoom 30
- Using the Flash 31
 - Flash Status Indicators 32
 - Precautions when Using Flash 32
- Recording Macro Images 34
- Using the Optical Viewfinder 35
- Recording Consecutive Images
(Continuous Shutter Mode) 35
 - Setting the Maximum Number of Shots 37

INTRODUCTION

| | |
|--|----|
| Using the Self-Timer | 37 |
| Specifying Image Size and Quality | 39 |
| To specify the image size | 39 |
| To specify the image quality | 39 |
| Exposure Compensation | 40 |
| Selecting White Balance | 42 |
| Checking an Image You Just Recorded | 42 |
| Using a Memory Card | 43 |
| To insert a memory card into the camera | 44 |
| To remove a memory card from the camera | 44 |
| To format a memory card | 45 |
| Memory Card Precautions | 46 |
| To copy flash memory images to a memory card | 47 |

48 PLAYBACK

| | |
|------------------------------------|----|
| Basic Playback Operation | 48 |
| Zooming the Displayed Image | 48 |
| Using the Slide Show Feature | 49 |

51 DELETING IMAGES

| | |
|---------------------------------------|----|
| Deleting a Single Image | 51 |
| Deleting All Unprotected Images | 53 |

54 MANAGING IMAGES

| | |
|--|----|
| Folders and Files | 54 |
| Folders | 54 |
| Files | 55 |
| Protecting Images Against Deletion | 55 |
| To protect or unprotect a single image | 55 |
| To protect or unprotect all images | 57 |
| DPOF | 58 |
| To print selected images | 58 |
| To print all images | 60 |
| PRINT Image Matching | 61 |

62 OTHER SETTINGS

| | |
|--|----|
| Turning the Monitor Screen Indicators On and Off ... | 62 |
| Changing the Display Language | 62 |
| Turning the Confirmation Tone On and Off | 63 |
| Selecting the USB Mode | 64 |

66 CONNECTING TO EXTERNAL EQUIPMENT

| | |
|--|----|
| Connecting to a Television | 67 |
| Selecting the Video Output Signal Mode | 67 |

| | |
|--|----|
| Transferring Images to a Computer | 68 |
| USB Connection | 68 |
| Connecting the USB Cable | 69 |
| Disconnecting the USB Cable | 70 |
| Using a Memory Card to Transfer Image Data | 70 |
| Memory Card Data | 71 |
| DCF Protocol | 71 |
| Memory Card File Structure | 72 |
| Image Files Supported by the Camera | 72 |
| Precautions when Using a Memory Card on a Computer | 73 |
| Using the PC Camera Mode | 74 |
| To connect the camera as a PC camera | 74 |
| Other Requirements | 75 |
| PC Camera Mode Precautions | 75 |
| Connecting to Your Computer | 75 |

76 REFERENCE

| | |
|--------------------------------|----|
| Camera Menus | 76 |
| REC mode | 76 |
| PLAY mode | 76 |
| Indicator Lamp Reference | 77 |
| REC mode | 78 |
| PLAY mode | 79 |
| Troubleshooting | 80 |
| Display Messages | 83 |
| Specifications | 85 |

88 SOFTWARE DRIVER INSTALLATION GUIDE

| | |
|---|----|
| Software Driver Installation Guid | 88 |
|---|----|

IMPORTANT!

- The contents of this manual are subject to change without notice.
- This digital camera makes it possible for you to record images for your own personal use. Never use it in a way that infringes upon the copyrights or other rights of others.
- The SD logo is a registered trademark. Windows and Internet Explorer are registered trademarks of Microsoft Corporation.
- Macintosh is a registered trademark of Apple Computer, Inc.
- MultiMediaCard is a trademark of Infineon Technologies AG of Germany, and licensed to the MultiMediaCard Association (MMCA).
- Other company, product and service names used herein may also be trademarks or service marks of others.

INTRODUCTION

Features

- High-resolution CCD with 2 million effective pixels (2.14 million total pixels)
- 1.5-inch TFT color LCD monitor screen
- 2X digital zoom
- Built-in 16MB flash memory
Images can be recorded without using a memory card.
- Supports SD memory cards and MultiMediaCards as removable storage.
- Digital Print Order Format (DPOF)
Images can be printed easily in the sequence you want using a DPOF compatible printer. DPOF can also be used when specifying images and quantities for printing by professional print services.
- PRINT Image Matching support
Images include PRINT Image Matching data (mode setting and other camera setup information). A printer that supports PRINT Image Matching reads this data and adjusts the printed image accordingly, so your images come out just the way you intended when you recorded them.
- DCF Data Storage
DCF (Design rule for Camera File system) data storage protocol provides image inter-compatibility between the digital camera and printers.
- VIDEO OUT terminal
Connect to your TV for big-screen viewing of images.
- USB compatibility
Connect to your computer for quick and easy image exchanged.
- PC Camera Function
Works as a video camera when connected to a computer for video conferencing.
- Software for PC-based image data management and handling
Bundled CD-ROM includes Photo Loader PC link software and Photohands image editing and printing software.
- Continuous Shutter Mode
Record up to five consecutive images.
- Macro Mode
Move in up to 20cm (7.9") from the subject.

Precautions

General Precautions

Be sure to observe the following important precautions whenever using the camera.

- Never try to take pictures or use the built-in display while operating a motor vehicle or while walking. Doing so creates the danger of serious accident.
- Never try to open the case of the camera or attempt your own repairs. High-voltage internal components create the risk of electric shock when exposed. Always leave maintenance and repair work up to authorized service providers.
- Never fire the flash in the direction of a person operating a motor vehicle. Doing so can interfere with the driver's vision and create the danger of accident.
- Never fire the flash while it is too close to the subject's eyes. Intense light from the flash can cause eye damage if it is fired too close to the eyes, especially with young children. When using the flash, the camera should be at least one meter from the eyes of the subject.
- Keep the camera away from water and other liquids, and never let it get wet. Moisture creates the danger of fire and electric shock. Never use the camera outdoors in the rain or snow, at the seashore or beach, in the bathroom, etc.
- Should foreign matter or water ever get into the camera, immediately turn power off, unplug the AC adaptor from the power outlet, and contact your dealer or nearest service provider. Using the camera under these conditions creates the danger of fire and electric shock.
- Should you ever notice smoke or a strange odor coming out of the camera, immediately turn power off and unplug the AC adaptor from the power outlet. Using the camera under these conditions creates the danger of fire and electric shock. After making sure there is no more smoke coming from the camera, take it to your nearest service provider for repair. Never attempt your own maintenance.
- At least once a year, unplug the AC adaptor from the power outlet and clean the area around the prongs of the plug. Dust build up around the prongs can create the danger of fire.
- If the camera's case should ever become cracked due to dropping it or otherwise subjecting it to rough treatment, immediately turn power off, unplug the AC adaptor from the power outlet, and contact your nearest service provider.
- Never use the camera inside of an aircraft or in any other areas where its use is prohibited. Doing so can result in an accident.
- Physical damage and malfunction of this camera can cause the image data stored in its memory to be deleted. Be sure to always keep backup copies of data by transferring them to personal computer memory.

INTRODUCTION

- Never open the battery cover, disconnect the AC adaptor from the camera or unplug it from the wall socket while recording images. Doing so will not only make storage of the current image impossible, it can also corrupt other image data already stored in camera memory.

Data Error Precautions

- Your digital camera is manufactured using precision digital components. Any of the following creates the risk of corruption of data in camera memory.
 - Removing batteries or disconnecting the AC adaptor while image recording or data communication is in progress.
 - Removing a memory card while image recording is in progress.
 - Removing batteries, unplugging the AC adapter, opening the memory card cover, or removing the memory card while the operation lamp is still lit after camera power is turned off.
 - Disconnecting the data communication cable.
 - Using low batteries.
 - Other abnormal operations.

Any of the above can cause a CARD ERROR message or INTERNAL MEMORY ERROR message to appear on the monitor screen. See page 83 for information about what you need to do when these messages appear.

Operating conditions

- This camera is designed for use in temperatures ranging from 0°C to 40°C.
- Do not use or keep the camera in the following areas.
 - In areas subject to direct sunlight
 - In areas subject to high humidity or dust
 - Near air conditioners, heaters, or other areas subject to temperature extremes
 - Inside of a closed vehicle, especially one parked in the sun
 - In areas subject to strong vibration

Condensation

- When you bring the camera indoors on a cold day or otherwise expose it to a sudden change of temperature, there is the possibility that condensation can form on the exterior or on interior components. Condensation can cause malfunction of the camera, so you should avoid exposing it to conditions that might cause condensation.
- To keep condensation from forming, place the camera into a plastic bag before moving it into a location that is much warmer or colder than your current location. Leave it in the plastic bag until the air inside the bag has a chance to reach the same temperature as the new location. If condensation does form, remove the batteries from the camera and leave the battery cover open for a few hours.

About the camera's backlight...

- The camera is equipped with a fluorescent light source to provide the back lighting for its LCD.
- The normal service life of the backlight is approximately five years, when the camera is used for about two hours a day.
- Under very cold conditions, the backlight may require more time than normal to light, or reddish bands may appear in the displayed image. These conditions do not indicate malfunction, and normal operation should return at higher temperatures.

Lens Precautions

- Fingerprints, dust, or any other soiling of the lens can interfere with proper image recording. Never touch the lens with your fingers. You can remove dust particles from the lens surface by using a lens blower to blow them off. Next, wipe the surface of the lens with a soft lens cloth.

INTRODUCTION

GUIDELINES LAID DOWN BY FCC RULES FOR USE OF THIS UNIT IN THE U.S.A. (not applicable to other areas).

This device complies with Part 15 of the FCC Rules. Operation is subject to the following two conditions: (1) this device may not cause harmful interference, and (2) this device must accept any interference received, including interference that may cause undesired operation.

NOTICE

This equipment has been tested and found to comply with the limits for a Class B peripheral, pursuant to Part 15 of the FCC Rules. These limits are designed to provide reasonable protection against harmful interference in a residential installation. This equipment generates, uses and can radiate radio frequency energy and, if not installed and used in accordance with the instructions, may cause harmful interference to radio communications. However, there is no guarantee that interference will not occur in a particular installation. If this equipment does cause harmful interference to radio or television reception, which can be determined by turning the equipment off and on, the user is encouraged to try to correct the interference by one or more of the following measures:

- Reorient or relocate the receiving antenna.
- Increase the separation between the equipment and receiver.
- Connect the equipment into an outlet on a circuit different from that to which the receiver is connected.
- Consult the dealer or an experienced radio/TV technician for help.

FCC WARNING

Changes or modifications not expressly approved by the party responsible for compliance could void the user's authority to operate the equipment.

Properly shielded cables with ferrite core must be used for connection to host computer and/or peripherals in order to meet FCC emission limits.

THE SPECIAL VIDEO CABLE THAT COMES WITH THE CAMERA
----- THE CAMERA TO A VIDEO IN TERMINAL OF A COMPUTER
THE SPECIAL CONNECTION CABLE THAT COMES WITH QV-Link SOFTWARE
----- THE CAMERA TO A PROPER TERMINAL OF A COMPUTER

GETTING ACQUAINTED

This section contains important information you should know when trying to operate the camera.

General Guide

The following illustrations show the names of each component, button, and switch on the camera.

Front

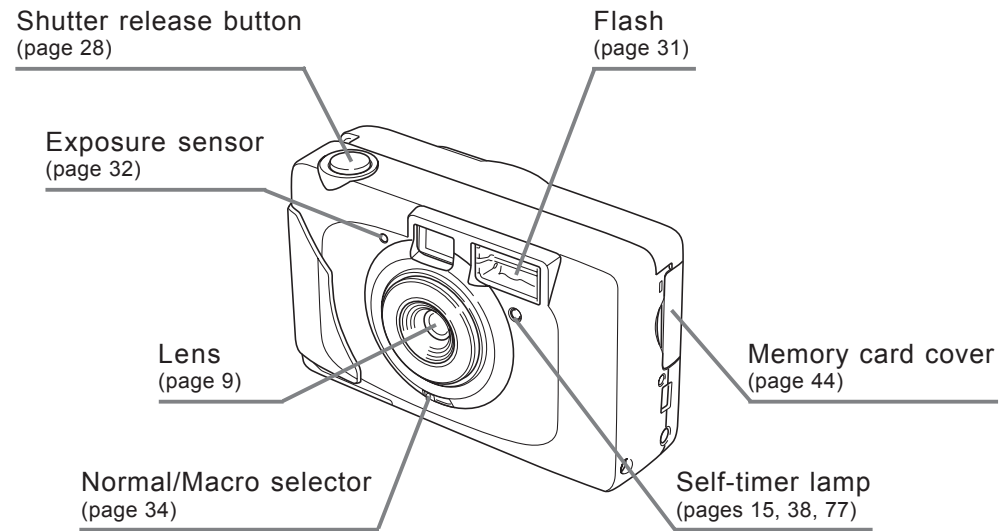

GETTING ACQUAINTED

Back

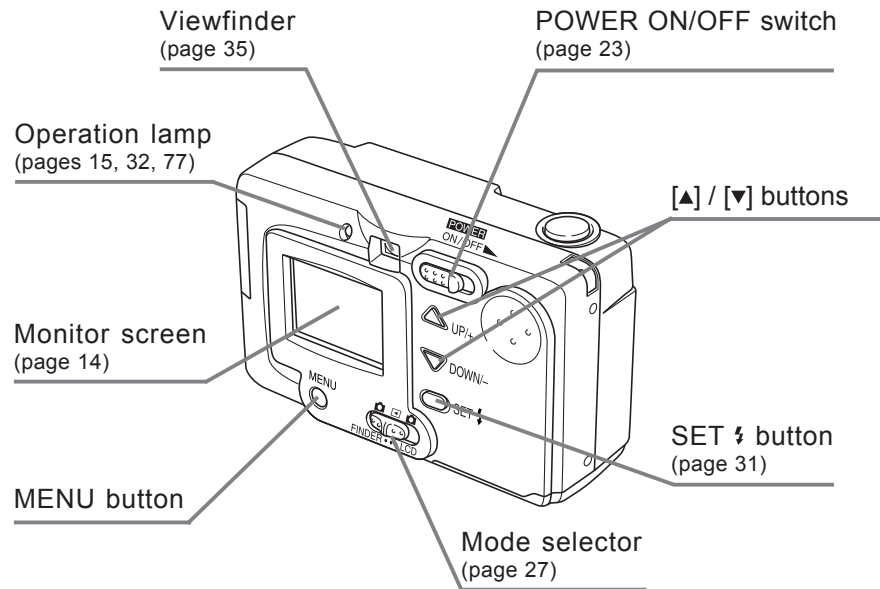

Side

Bottom

Card access lamp
(pages 15, 45, 77)

USB port
(pages 66, 69, 74)

Tripod screw hole

Battery cover
(page 18)

VIDEO OUT terminal
(pages 66, 67)

DC IN 6V terminal
(page 22)

GETTING ACQUAINTED

Monitor Screen Indicators

The following describes the different indicators and markings that appear on the camera's monitor screen.

REC mode

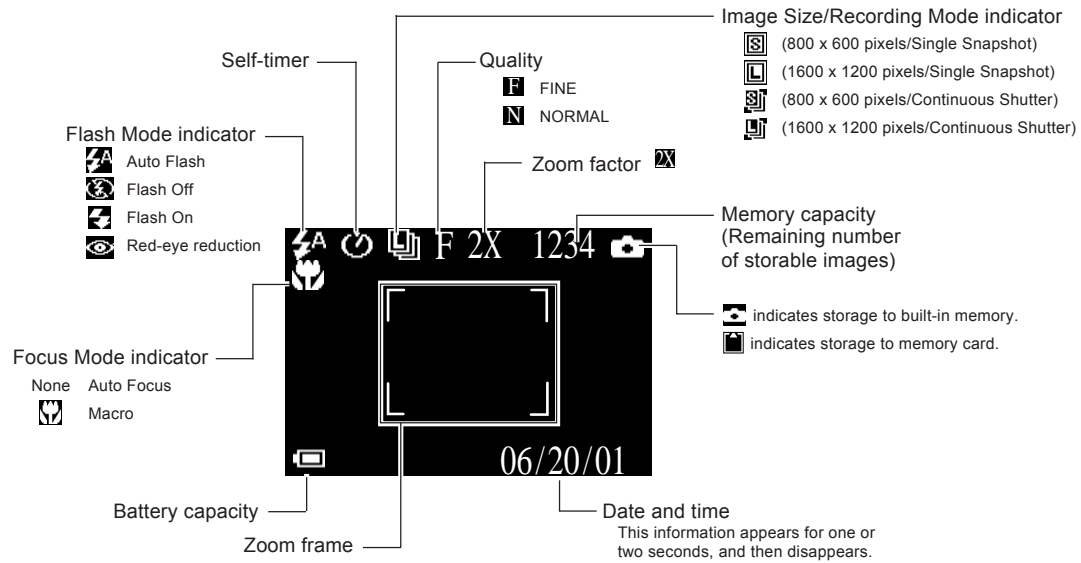

PLAY mode

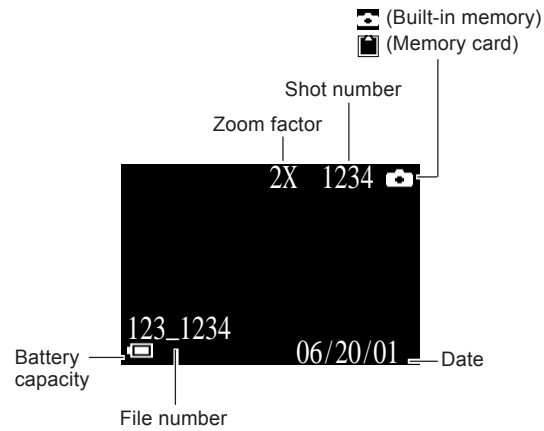

The above indicators do not appear on the PLAY mode monitor screen when the "Indicators" option is turned off (page 62).

▶▶ IMPORTANT! ◀◀

- The above indicators may not appear when viewing images recorded using a different digital camera model.

Indicator Lamps

The camera has three indicator lamps, an operation lamp, a card access lamp, and a self-timer lamp. These lamps indicate the current operational status of the camera by lighting, flashing, and changing color. For details, see "Indicator Lamp Reference" on page 77.

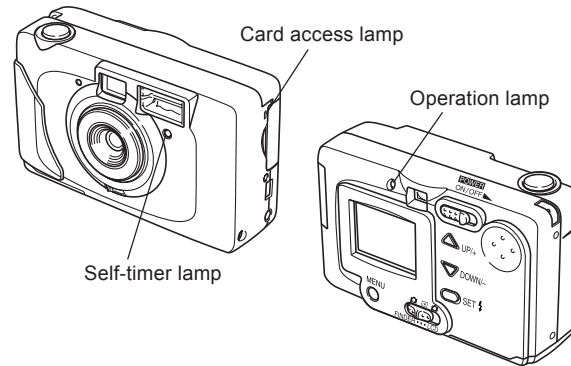

GETTING ACQUAINTED

Attaching the Strap

Attach the strap as shown in the illustration below.

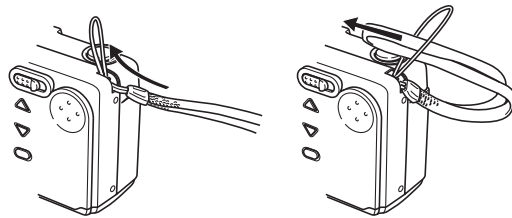

▶▶ IMPORTANT! ◀◀

- Be sure to keep the strap around your wrist when using the camera to protect against accidentally dropping it.
- The supplied strap is intended for use with this camera only. Do not use it for any other application.
- Never swing the camera around by the strap.

Using the Soft Case

Keep the camera in its soft case to protect it when not in use.

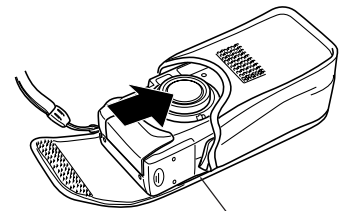

Monitor screen facing down

▶▶ IMPORTANT! ◀◀

- ¥ Never put any other objects besides the camera into the soft case.

Power Requirements

Your camera features a two-way power supply that lets you use either AA-size batteries or household AC current. A set of AA-size alkaline batteries is supplied with the camera. The other items listed below are available separately.

- Batteries
 - Four AA-size alkaline batteries: LR6
 - Four AA-size lithium batteries: FR6
 - Four AA-size nickel-metal hydride rechargeable batteries: NP-H3
- ▶▶ IMPORTANT! ◀◀
 - Never use manganese batteries. Use only the battery types specifically mentioned in this User's Guide.
- Household Current
 - AC Adaptor: AD-C620
 - AC Adaptor/Charger: BC-3HA

GETTING ACQUAINTED

Loading Batteries

Make sure that camera power is turned off whenever loading or replacing batteries.

1. Turn the camera over, and slide the battery cover in the direction indicated by the arrow in the illustration to open it.

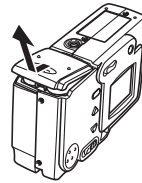

2. Load batteries as shown in the illustration, and then close the battery cover by pressing down on it as you slide it in the direction indicated by the arrow.

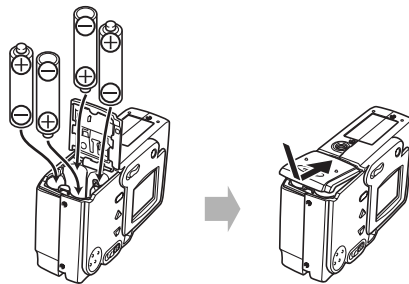

Battery Life Guidelines

The battery life guideline values given below indicate the amount of time at standard temperature (25°C) until power automatically turns off due to battery failure. They do not guarantee that batteries will provide the amount of service indicated. Low temperatures and continued use reduce battery life.

| Type of Operation | AA-size Alkaline Batteries LR6 | AA-size Lithium Batteries FR6 | AA-size Ni-MH Batteries NP-H3 |
|----------------------|--------------------------------|-------------------------------|-------------------------------|
| Continuous Playback | 140 minutes | 300 minutes | 160 minutes |
| Continuous Recording | 120 minutes (720 shots) | 290 minutes (1740 shots) | 150 minutes (900 shots) |

- The above figures are approximations only.
- The above guidelines are based on the following battery types:
Alkaline: MX1500 (AA) DURACELL ULTRA
Lithium: Energizer
- Figures are based on continuous recording under the following conditions:
Flash turned off
Normal temperature (25°C)
- Recording one image per minute under the above conditions reduces battery life to about one sixth of that noted above.
- Battery life is greatly affected by how much you use flash, zoom and other functions, and how long you leave power turned on.

GETTING ACQUAINTED

CAUTION!

- Battery life differs greatly by manufacturer. We recommend use of MX 1500 (AA) DURACELL ULTRA alkaline batteries with this product.

● Tips for Prolonging Battery Life

- Use the SET  button to turn off the flash when you are not using it.

● Alkaline Battery Life

The actual life of alkaline batteries is affected by a variety of factors, including the battery manufacturer, the amount of time the batteries spend in storage before you use them, temperature while you are recording, and photographic conditions. As a rule, we recommend the use of lithium batteries or Ni-MH batteries, which have longer lives than alkaline batteries.

The following examples show how alkaline battery life changes under different conditions.

Example 1: Intermittent use of the camera shortens battery life.

Conditions

- Temperature: 25°C
- Repeat of a cycle of recording of one shot per minute for 10 minutes, followed by one minute of playback, and a nine minutes of power off
- Flash on

Approximate Battery Life: 60 minutes (55 shots)

Example 2: Low temperatures shorten battery life.

Conditions

- Temperature: 0°C
- Repeat of a cycle of recording of one shot per minute for 10 minutes, followed by one minute of playback, and a nine minutes of power off
- Flash on

Approximate Battery Life: 15 minutes (14 shots)

GETTING ACQUAINTED

● About rechargeable batteries

Use only the nickel-metal hydride batteries (NP-H3) that are available from your dealer as options for this camera. Proper camera operation is not guaranteed when other rechargeable batteries are used.

AC Adaptor/Charger : BC-3HA

Nickel-metal hydride batteries (4-battery set)/Quick Charger Set : BC-1HB4

Nickel-metal hydride batteries (4-battery set) : NP-H3P4

▶▶ IMPORTANT! ◀◀

- Be sure to keep all four batteries together as a set at all times, for both charging and powering the camera. Mixing batteries from different sets can shorten overall battery life and cause malfunction of the camera.
- Rechargeable batteries cannot be charged while they are loaded in the camera.

Battery Handling Precautions

- Incorrect use or handling of batteries can cause them to leak or burst and create the danger of serious damage to your camera. Be sure to note the following important precautions to avoid problems with batteries.
 - Always make sure that the plus (+) and minus (-) ends of the batteries are facing correctly, as noted by the markings on the camera itself. Improper loading of batteries can result in bursting or leaking of batteries, creating the danger of personal injury or soiling of objects nearby.
 - Never mix old batteries with new ones. Doing so can result in bursting or leaking of batteries, creating the danger of fire or personal injury.
 - Never mix batteries of different types.
 - Use only LR6 type alkaline or FR6 type lithium or Ni-MH (nickel-metal hydride) dry cell batteries with this camera.



Caution!





Caution!

- Never recharge non-rechargeable type batteries, never allow direct connection between two ends of a battery, and never try to take batteries apart.
 - Do not expose batteries to direct heat or dispose of them by burning. Doing so can create the danger of explosion.
 - Dead batteries are susceptible to leakage, which can cause serious damage to your camera. Remove batteries from the camera as soon as you notice they are dead.
- Remove batteries from the camera if you do not plan to use it for more than two weeks.
 - The batteries that power the camera normally become warm as they discharge.

Low Battery Indicator

The following shows how the battery capacity indicator on the monitor screen and the indicator display changes as battery power is used. Replace all four batteries as soon as possible after they go dead. If you continue to use the camera while the battery level is , camera power will automatically turn off.

| | |
|------------------|---|
| Battery Capacity | High ←————→ Low |
| Monitor Screen |  →  →  |

GETTING ACQUAINTED

Using AC Power

Use the adaptor as shown below to power the camera from a household power outlet.

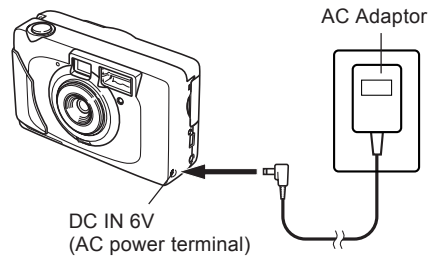

- AC Adaptor: AD-C620 (Option)
- AC Adaptor/Charger: BC-3HA (Option)
The BC-3HA functions both as an AC adaptor and as a charger unit for AA-size nickel-metal hydride batteries. It comes complete with four rechargeable nickel-metal hydride batteries. This AC adaptor/charger unit can be used with any household power outlet rated for 100V to 240V AC.

AC Adaptor precautions

- Never use an electrical outlet whose voltage is outside the rating marked on the AC adaptor. Doing so can create the danger of fire or electric shock. Use only the optional AC adaptor specified for this camera.
- Do not allow the AC adaptor power cord to become cut or damaged, do not place heavy objects on it, and keep it away from heat. A damaged power cord creates the risk of fire and electric shock.
- Never try to modify the AC adaptor power cord, or subject it to severe bending, twisting, or pulling. Doing so creates the risk of fire and electric shock.
- Never touch the AC adaptor while your hands are wet. Doing so creates the risk of electric shock.
- Do not overload extension cords or wall outlets. Doing so creates the danger of fire and electric shock.
- Should the cord of the AC adaptor become damaged (exposed internal wiring), request a replacement from an authorized service provider. A damaged AC adaptor cord creates the danger of fire or electric shock.



- Be sure to turn off power before connecting or disconnecting the adaptor.
- Always turn camera power off before disconnecting the AC adaptor, even if the camera has batteries installed. If you don't, the camera will turn off automatically when you disconnect the AC adaptor. You also run the risk of damaging the camera whenever you disconnect the AC adaptor without first turning power off.
- The AC adaptor may become warm to the touch after extended periods of use. This is normal and is not cause for alarm.
- After using the camera, turn it off and unplug the adaptor from the AC outlet.
- The camera automatically switches over to AC adaptor powered operation whenever the AC adaptor is plugged into the camera.
- Always use the AC adaptor to power the camera whenever it is connected to a computer.

Turning the Camera On and Off

Use the POWER ON/OFF switch to turn the camera on and off. Sliding the POWER ON/OFF switch in the direction indicated by "▶" toggles power on and off. The operation lamp is lit while camera power is turned on.

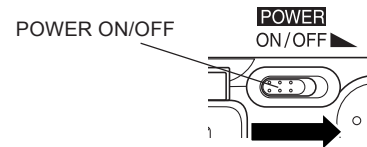

GETTING ACQUAINTED

Power Save Settings

The camera performs the following power save operations to conserve battery power.

Auto Power Off : Automatically turns off the camera if no operation is performed for five minutes.

Sleep : Automatically turns off the monitor screen if no operation is performed for two minutes. Performing any button operation causes the monitor screen to turn back on.

- Auto Power Off is automatically disabled under any one of the following conditions.
 - While a slideshow is playing
 - While the camera's USB port is connected to a computer or other external device, or while the camera is being controlled by an external device
 - While the AC adaptor is connected to the camera

Setting the Current Date and Time

Use the following procedures to set the current date and time, and to select the date format.

When you record an image, the date and time the image was shot is registered in accordance with data from the camera's built-in clock.

!!! IMPORTANT! !!!

- The date and time settings are cleared if the camera is left for about 12 hours without battery and AC power being supplied. If this happens, restore power and make new date and time settings before using the camera again.
- The date and time setting screen appears first when you turn on the camera after the date and time settings are cleared.
- If you do not set the camera's built-in clock to the current date and time, all images are recorded with the default date and time, which probably is not your correct current date and time. Be sure to correctly set the clock before you use the camera.

Setting the Date and Time

1. Turn on the camera, and then align the mode selector with LCD or .
2. Press MENU.
3. Use **[▲]** and **[▼]** to select “SET UP (BASIC)” or “SET UP” and then press SET .
4. If you aligned the mode selector with LCD in step 1, use **[▲]** and **[▼]** to select “SET UP (BASIC)” and then press SET .
 - If you aligned the mode selector with , skip step 4.
5. Use **[▲]** and **[▼]** to select “DATE & TIME” and then press SET .
6. Select and adjust each item to set the date and time.

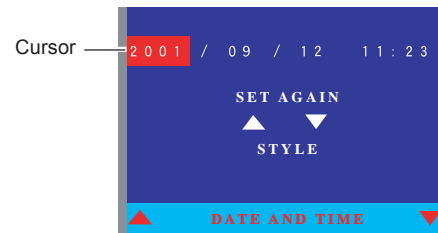

| To do this: | Press this button: |
|-------------------------------------|--------------------------|
| Move the cursor to the next setting | SET |
| Change the setting | [▲] or [▼] |

- The following describes how to use the SET AGAIN and STYLE items.

| To do this: | Do this: |
|--------------------------------|---|
| Change the date format | Move the highlighting to STYLE and then press SET . |
| Go back up to the date setting | Move the highlighting to SET AGAIN and then press SET . |

GETTING ACQUAINTED

7. After the date setting is the way you want, use [▲] and [▼] to select "STYLE" and then press SET ⏏.
8. On the date format screen that appears, use [▲] and [▼] to select the format you want and then press SET ⏏.
9. Press MENU.

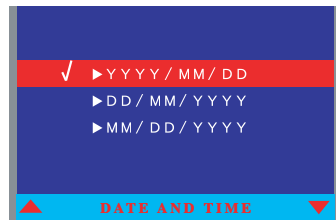

Example: October 18, 2001

| To display the date this way: | Select this format: |
|-------------------------------|---------------------|
| 2001/10/18 | YYYY/MM/DD |
| 18/10/2001 | DD/MM/YYYY |
| 10/18/2001 | MM/DD/YYYY |

RECORDING IMAGES

This section describes the basic procedure for recording an image.

Recording a Simple Snapshot

Your camera automatically adjusts shutter speed and aperture setting in accordance with the brightness of the subject. Recorded images can be saved to the camera's built-in flash memory or to a commercially available memory card (SD memory card or MultiMediaCard).

1. Slide the POWER ON/OFF switch to the right to turn on the camera.

This causes an image or a message to appear on the monitor screen.

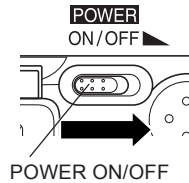

2. Align the mode selector with the LCD.

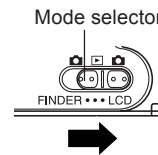

The following describes the different settings that are available with the mode selector.

| To do this: | Align the mode selector with this setting: |
|---|--|
| Enter the REC mode with the monitor screen turned off, so you can use the optical viewfinder to compose images, which conserves battery power | FINDER |
| Enter the PLAY mode and display images on the monitor screen | |
| Enter the REC mode with the monitor screen turned on, so you can use it to compose image | LCD |

RECORDING IMAGES

3. Compose the image on the monitor screen.



- The focusing range of the camera is about 80cm to ∞ (31.5" to ∞).
- You can compose images using either the monitor screen or the optical viewfinder (page 35).
- When using the optical viewfinder to compose images, you can set the mode selector to  FINDER, which turns off the monitor screen and conserves battery power.

4. Press the shutter release button about half way to lock the exposure (AE Lock).

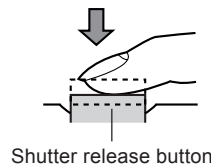

- When performing this step, take care so your fingers do not block the lens or any of the sensors.
- All indicators turn green while AE Lock is activated. The indicators turn red if the subject is too dark or too bright.

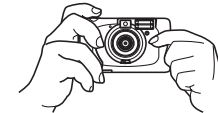

5. Press the shutter release button the rest of the way to record the image.

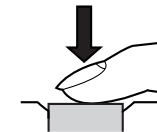

- The number of images you can store in the camera depends on the storage medium and the image quality setting (page 39) you are using.
- To avoid hand movement, press the shutter release button gently.
- Use of a tripod is recommended for slow shutter speeds due to dim light and telephoto shots to avoid blurring of the image due to camera movement.

About the REC Mode Monitor Screen

- The image shown on the monitor screen in the REC mode is a simplified image for composing purposes. The actual image is recorded in accordance with the image quality setting currently selected on your camera. The image saved on the memory card has much better resolution and detail than the REC mode monitor screen image.
- Certain levels of subject brightness can cause the response of the REC mode monitor screen to slow down, which causes some static noise in the monitor screen image.

Recording Precautions

- Never open the battery cover, disconnect the AC adaptor from the camera, or unplug the adaptor from the wall socket while the operation lamp is flashing green. Doing so will not only make storage of the current image impossible, it can also corrupt other image data already stored on the camera's built-in flash memory or on a memory card.
- Never remove batteries, disconnect the AC adaptor, or remove the memory card while an image is being saved to built-in flash memory or to a memory card.
- Fluorescent lighting actually flickers at a frequency that cannot be detected by the human eye. When using the camera indoors under such lighting, you may experience some brightness or color problems with recorded images.

RECORDING IMAGES

Using Zoom

You can use the digital zoom feature of your camera to zoom in on the center of an image. Performing a zoom operation toggles the zoom factor between 2X and 1X.

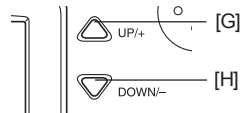

▶▶ IMPORTANT! ◀◀

- Digital zoom is available only when camera's image size setting (page 39) is "L 1600 x 1200." Digital zoom does not work when "S 800 x 600" is selected as the image size.

1. Align the mode selector with LCD.
2. Use [▲] and [▼] to select the digital zoom factor you want.

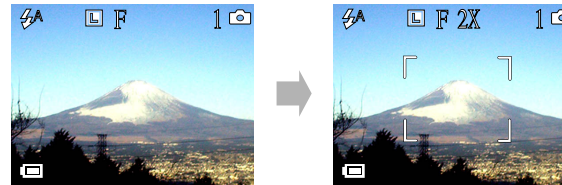



| To select this digital zoom factor: | Press this button: |
|-------------------------------------|--------------------|
| 2X | [▲] |
| 1X | [▼] |

- Selecting the 2X zoom factor displays a zoom frame on the monitor screen. Only the area within the zoom frame is recorded when you press the shutter release button.



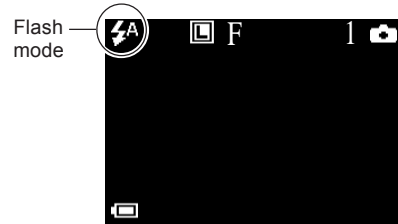
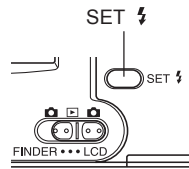

Using the Flash

The following describes various flash settings you can make to suit the type of image you are trying to record.

1. Align the mode selector with  LCD.
2. Press SET  to cycle through the flash mode settings until the one you want is indicated on the monitor screen.



- Each press of SET  cycles through the available flash modes described below.

| To do this: | Select this setting: |
|--|---|
| Have the flash fire automatically when required (Auto Flash) |  |
| Turn off the flash (Flash Off) |  |
| Always fire the flash (Flash On) |  |
| Fire a pre-flash followed by image recording with flash, reducing the chance of red-eye in the image (Red-eye reduction) |  |

RECORDING IMAGES

Flash Status Indicators

You can find out whether the flash will fire when you record by pressing the shutter release button about half way down and checking the status of the operation lamp.

| If the operation lamp does this: | It means this: |
|----------------------------------|--------------------------|
| Lights amber | The flash will fire. |
| Does not light amber | The flash will not fire. |

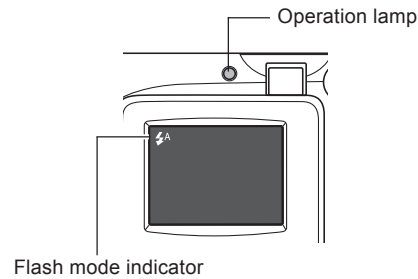

Precautions when Using Flash

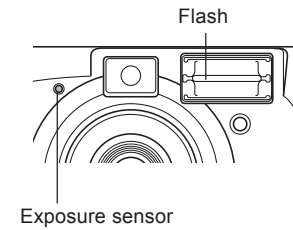

- Make sure that you do not touch or block the flash or the exposure sensor with your fingers. Doing so can soil these components and interfere with correct flash operation.

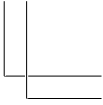
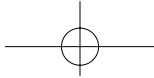

- Depending on operating conditions (type of batteries being used, temperature, etc.), it may take up to 10 seconds for the flash unit to charge (when fresh batteries are loaded in the camera).
- The flash unit may not be able to charge when battery power is low. Low battery power is indicated when the flash mode indicator on the monitor screen turns red, and the flash fails to fire, resulting in improper image exposure. Replace batteries as soon as possible after any of these symptoms occurs.



RECORDING IMAGES



- Red-eye reduction  may not work well when the camera is not pointed directly at the subject or when the subject is far from the camera.
 - In the Red-eye reduction , the flash is fired automatically in accordance with exposure. Because of this, the flash does not fire if the subject is well-lit.
 - White balance is fixed while the flash is being used, so sunlight, fluorescent lighting, or other sources of illumination in the immediate area may affect the coloring of the recorded image.
- 

RECORDING IMAGES

Recording Macro Images

You can select either normal or macro (close-up) recording using the selector located under the lens on the front of the camera.

The table below describes the two settings available with the selector.



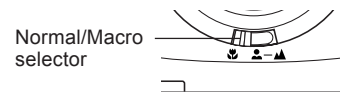

| To do this: | Select this setting: |
|---|--|
| Shoot normal images, at a distance of about 80cm to ∞ (31.5" to ∞) (Normal) |  |
| Shoot close-ups, at a distance of about 20cm (7.9") (Macro) |  |

- The distances indicated above represent the distance from the camera's lens surface to the subject.



- Selecting the macro mode causes the  indicator to appear on the monitor screen.



- Normally, you should leave the Normal/Macro selector setting at .
- You can select either flash off  or flash on  only in the macro mode. The initial default setting is flash off .

Using the Optical Viewfinder

Note the following points whenever you use the optical viewfinder to compose images.

Optical viewfinder

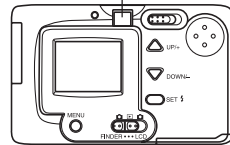

The frame that is visible inside of the viewfinder indicates the image recorded at a distance of about three meters (9.8'). When the subject is closer or further away than three meters (9.8'), the recorded image will be different from what you see inside the viewfinder frame.

- When your subject is closer than three meters (9.8'), set the Normal/Macro selector to and use the macro mode to record. Note that selecting the macro mode automatically turns on the monitor screen, which you should use to compose the image.
- You can turn off the monitor screen by setting the mode selector to FINDER.
- Pressing MENU while the mode selector is set to FINDER causes the monitor screen indicators to appear.
- No settings besides the flash mode can be changed while the mode selector is set to FINDER.

Recording Consecutive Images (Continuous Shutter Mode)

Using the following procedure, you can record up to five consecutive images by holding down the shutter release button.

1. Align the mode selector with LCD.
2. Press MENU.
3. Use [▲] and [▼] to select "DRIVE MODE" and then press SET .
4. Use [▲] and [▼] to select "CONTINUOUS" and then press SET .

The following describes the drive mode options.

| To do this: | Select this option: |
|--------------------------------------|---------------------|
| Record a series of up to five images | CONTINUOUS |
| Record a single snapshot | SINGLE |

RECORDING IMAGES

5. Press MENU or select "EXIT" and then press SET .

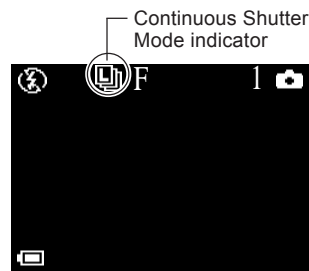

6. Hold down the shutter release button to record the images you want.





»» IMPORTANT! ««

- The flash does not fire during Continuous Shutter recording.
- You cannot use the self-timer in combination with the Continuous Shutter Mode.
- A slow shutter speed increases the interval between Continuous Shutter Mode shots.
- Continuous Shutter recording is disabled while the  battery indicator is on the monitor screen. The camera automatically switches to the Single Mode at this time.
- Never remove the batteries from the camera or unplug the AC adaptor while images are being saved to memory.

Setting the Maximum Number of Shots



You can use the following procedure to specify the maximum number of shots that can be recorded in the Continuous Shutter Mode. You can specify a value in the range of 2 to 5.

■ Normally you can specify a value in the range of 2 to 5, but the actual number of images you will be able to record depends on the subject and other factors.

1. Align the mode selector with  LCD.
2. Press MENU.
3. Use [▲] and [▼] to select "SET UP" and then press SET .
4. Use [▲] and [▼] to select "CONTINUOUS SHOT NO." and then press SET .
5. Use [▲] and [▼] to specify the number of shots and then press SET .
6. Press MENU.

Using the Self-Timer

You can set the self-timer to one of two countdown times.

1. Align the mode selector with  LCD.
2. Press MENU.
3. Use [▲] and [▼] to select "SELF TIMER" and then press SET .
4. Use [▲] and [▼] to select the self-timer setting you want and then press SET .

| To do this: | Select this setting: |
|------------------------------------|----------------------|
| Turn off the self-timer | OFF |
| Specify a countdown of two seconds | 2 SEC |
| Specify a countdown of ten seconds | 10 SEC |

RECORDING IMAGES

5. Press MENU or select "EXIT" and then press SET .

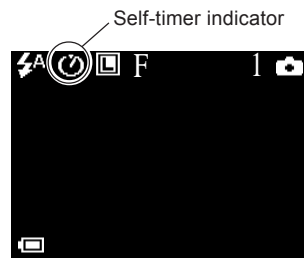

- The  indicator on the monitor screen indicates that the self-timer is turned on.

6. Compose the image and then press the shutter release button.

- The self-timer lamp flashes to indicate that the countdown is being performed.
- You can interrupt an ongoing self-timer countdown by pressing the shutter release button while the self-timer lamp is flashing.

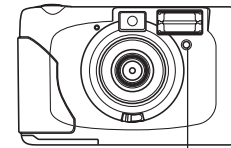



Self-timer lamp

- The self-timer turns off automatically after recording an image.

Specifying Image Size and Quality

You can specify the image size and image quality to suit the type of image you are recording.



To specify the image size

1. Align the mode selector with  LCD.
2. Press MENU.
3. Use [▲] and [▼] to select "SIZE" and then press SET .
4. Use [▲] and [▼] to specify the image size and then press SET .

| To specify this image size: | Select this setting: |
|-----------------------------|----------------------|
| 1600 x 1200 pixels (large) | L 1600 x 1200 |
| 800 x 600 pixels (small) | S 800 x 600 |

5. Press MENU or select "EXIT" and then press SET .

To specify the image quality

1. Align the mode selector with  LCD.
2. Press MENU.
3. Use [▲] and [▼] to select "QUALITY" and then press SET .
4. Use [▲] and [▼] to specify the image quality and then press SET .

| To specify this image quality: | Select this setting: |
|--|----------------------|
| Fine quality with little compression | FINE |
| Normal quality with standard compression | NORMAL |

5. Press MENU or select "EXIT" and then press SET .

RECORDING IMAGES

● Size/Quality Setting and Image Capacity

| Image size (pixels) | Quality | File size | Number of images | |
|---------------------|---------|-----------|----------------------------|---------------------|
| | | | Built-in flash memory 16MB | SD Memory Card 64MB |
| 1600x1200 | FINE | 850KB | 16 | 62* |
| | NORMAL | 600KB | 23 | 88* |
| 800x600 | FINE | 200KB | 67 | 258* |
| | NORMAL | 150KB | 92 | 352* |

* The number of image values marked with an asterisk is based on the SD memory card made by Matsushita Electric Industrial Co., Ltd. The actual number of images depends on the brand of SD memory card you use.



▶▶ IMPORTANT! ◀◀

- The values in the table are all approximate, and are affected by the types of images you record and other factors.
- To determine the number of images that can be stored on a memory card of a different capacity, multiply the capacities in the table by the appropriate value.
- The maximum number of stored images that can be indicated on the camera's display is 9,999. Depending on the memory card capacity, more images can be stored, but only up to 9,999 are indicated on the display.

Exposure Compensation

You can adjust the exposure compensation value (EV value) within the range shown below in order to compensate for current lighting conditions. This setting can be used to obtain better results when shooting with backlighting, indirect indoor lighting, a dark background, etc.

EV Value Range: -2EV to +2EV
Steps: 1/3EV

1. Align the mode selector with  LCD.
2. Press MENU.
3. Use [▲] and [▼] to select "EXPOSURE" and then press SET .



4. Use [▲] and [▼] to perform exposure compensation (EV shift) and then press SET .

- This registers the EV shift value you specify.

[▲] : Increases the EV value. A higher EV value is best used for light-colored subjects and backlight subjects.



[▼] : Decreases the EV value. A lower EV value is best for dark-color subjects and for shooting outdoors on a clear day.

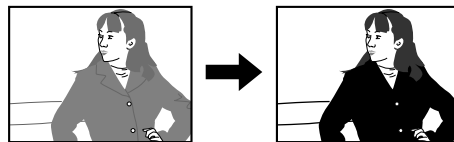

- To return exposure compensation to its standard default setting, use [▲] and [▼] to change the setting on the monitor screen back to "AUTO."

5. Press MENU or select "EXIT" and then press SET .



▶▶ IMPORTANT! ◀◀





- When shooting under very dark or very bright conditions, you may not be able to obtain satisfactory results even after performing exposure compensation. Exposure compensation returns to its standard default setting (AUTO) after you record an image.

RECORDING IMAGES

Selecting White Balance

Selecting the right type of white balance can help to make the colors of a subject appear most natural under the type of lighting that is available.

1. Align the mode selector with  LCD.
2. Press MENU.
3. Use [▲] and [▼] to select “WHITE BALANCE” and then press SET .
4. Use [▲] and [▼] to select a white balance setting and then press SET .





| When shooting under these conditions: | Select this setting: |
|---|--|
| Normal conditions (Camera adjusts white balance automatically.) | Auto |
| Outdoor daylight |  |
| Shade |  |
| Indoors, illuminated by light bulbs |  |
| Indoors, illuminated by fluorescent lighting |  |

5. Press MENU or select “EXIT” and then press SET .

42

Checking an Image You Just Recorded

Perform the following steps to set up the camera to display an image right after you record it.

1. Align the mode selector with  LCD.
2. Press MENU.
3. Use [▲] and [▼] to select “SET UP” and then press SET .
4. Use [▲] and [▼] to select “SHOT REVIEW” and then press SET .
5. Use [▲] and [▼] to select the setting you want and then press SET .

| To do this: | Select this setting: |
|---|----------------------|
| Have the camera display the image you record for about two seconds after you record it. | ON |
| Record normally, without image display | OFF |

6. Press MENU.

Using a Memory Card

Your camera comes with 16MB of built-in flash memory for storing images as you record them. You can expand memory using a commercially available memory card (SD memory card). You can also copy images from built-in flash memory to a memory card.

The camera senses whether a memory card is inserted, and automatically saves images accordingly.

- When you do not have a memory card installed in the camera, recorded images are saved to built-in flash memory.
- When you have a memory card installed in the camera, recorded images are saved to the memory card.
- Note that you cannot save images to built-in flash memory while a memory card is installed in the camera.

▶▶ IMPORTANT! ◀◀

- Make sure you turn off the camera before inserting or removing a memory card.
- Be sure to orient the card correctly when inserting it. Never try to force a memory card into the slot when you feel resistance.
- Though the camera also supports use of an MMC (MultiMediaCard) in place of an SD memory card, the data processing speed in the case of an MMC is much slower than that for an SD memory card. Because of this, we recommend that you choose an SD memory card whenever possible.
- SD memory cards have a write protect switch, which you can use to protect against accidental deletion of image data. Note, however, if you write protect an SD memory card, you must remove write protection whenever you want to record to it, format it, or delete any of its images.

RECORDING IMAGES

To insert a memory card into the camera

1. Open the memory card cover.

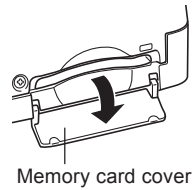

2. Making sure that the terminals of the memory card is facing towards the front of the camera, carefully insert the card into the slot as far as it will go.

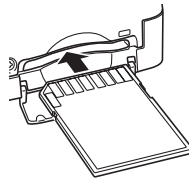

3. Close the memory card cover.

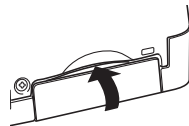

To remove a memory card from the camera

1. Open the memory card cover.

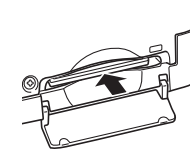

2. Press the memory card into the camera and then release it. This will cause the card to come part way out of the camera.

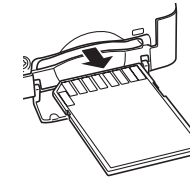

3. Pull the memory card out of the slot.

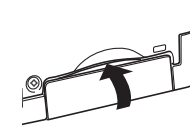

4. Close the memory card cover.

»» IMPORTANT! ««

- Never insert any other object besides a memory card into the camera's card slot. Doing so creates the risk of damage to the camera and card.
- Should water or any foreign object ever get into the card slot, immediately turn off the camera, remove the batteries or disconnect the AC adaptor, and contact your dealer or nearest service provider.
- Never remove a card from the camera while the card access lamp is flashing. Doing so can cause the image record operation to fail, and even damage the memory card.





To format a memory card

Formatting a memory card deletes any data already stored on it.

»» IMPORTANT! ««

- You can format a memory card on the camera or on a computer. Note, however, that formatting a card on a computer takes much longer than formatting on the camera. Because of this, we recommend that you use the camera for formatting whenever possible.
- Note that data deleted by a format operation cannot be recovered. Make sure you do not need any data currently stored on a memory card before you format it.
- Formatting a memory card that contains images deletes all the images, even those that are protected (page 55).

RECORDING IMAGES

1. Turn on the camera, and then align the mode selector with  LCD or .
2. Press MENU.
3. Use [▲] and [▼] to select "FORMAT" and then press SET .
4. Use [▲] and [▼] to select "YES, FORMAT" and then press SET .

| To do this: | Select this option: |
|-----------------------------|---------------------|
| Format the memory card | YES, FORMAT |
| Cancel the format operation | NO |



5. Press MENU or select "EXIT" and then press SET .

Memory Card Precautions

- Use only an SD memory card or a MultiMediaCard with this camera. Proper operation is not guaranteed when any other type of card is used.
- Electrostatic charge, electrical noise, and other phenomena can cause data to become corrupted or even lost. Always make sure that you always back up important data on other media (MO disc, computer hard disk, etc.)
- If a memory card starts to behave abnormally, you can restore normal operation by reformatting it. However, we recommend that you always take along more than one memory card whenever using the camera far away from the home or office.
- We recommend that you format a memory card before using it for the first time after purchasing it, or whenever the card you are using seems to be the cause of abnormal images.
- Before starting a format operation, connect the AC adaptor for power or load a full set of fresh alkaline or lithium batteries. Power interruption during the format operation can result in improper formatting, and even damage the memory card and make it unusable.

To copy flash memory images to a memory card

The following procedure copies all images currently in the camera's built-in flash memory to a memory card.

1. Load a memory card into the camera.
2. Align the mode selector with .
3. Press MENU.
4. Use [▲] and [▼] to select "COPY TO CARD" and then press SET .



- This starts the copy operation.
- After all the images are copied to the card, the message "COPY COMPLETED." appears on the camera's monitor screen.

5. Press MENU or select "EXIT" and then press SET .

►► IMPORTANT! ◀◀



- You cannot copy images from the memory card to the camera's built-in flash memory.



PLAYBACK

You can use the camera's built in monitor screen to play back recorded images.

Basic Playback Operation

Use the following procedure to scroll through recorded images stored in the camera's memory.









1. Align the mode selector with .
 - This enters the PLAY mode.
2. Use  and  to scroll through images on the monitor screen.



| To do this: | Press this button: |
|----------------|---|
| Scroll forward |  |
| Scroll back |  |





Zooming the Displayed Image

Perform the following procedure to zoom the image currently on the monitor screen.

1. Align the mode selector with .
2. Use  and  to scroll through images until the one you want is displayed.
3. Press MENU.
4. Use  and  to select "ZOOM" and then press SET .
5. Use  and  to select the area of the image you want to enlarge.

| To do this: | Press this button: |
|---------------------------------------|---|
| Move to the next lower numbered area |  |
| Move to the next higher numbered area |  |

- To exit the zoom operation, use  and  to cycle through the areas until "CANCEL" appears in the center of the monitor screen, and then press SET .

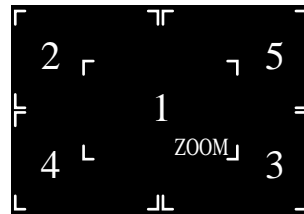

6. Press SET ζ to zoom in on the currently selected area.
7. To exit the zoomed image, press \blacktriangle or \blacktriangledown to change to another image, or press SET ζ or MENU.

Using the Slide Show Feature

Slide Show automatically plays back images in sequence at a fixed interval.



1. Align the mode selector with \blacktriangleright .
2. Press MENU.
3. Use \blacktriangle and \blacktriangledown to select "SLIDE SHOW" and then press SET ζ .
 - This starts the slideshow.
4. To quit the slideshow, press MENU, \blacktriangle , \blacktriangledown , or SET ζ .
5. Press MENU or select "EXIT" and then press SET ζ .



PLAYBACK

▶▶ IMPORTANT! ◀◀

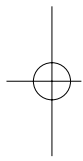
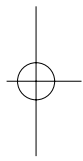
- Auto Power Off (page 24) is disabled whenever Slide Show is being used. This means you should not leave Slide Show running when using batteries to power the camera. Doing so can run down batteries. Be sure to stop Slide Show and turn off the camera after you are finished.
 - Note that all buttons are disabled while an image change is in progress. Wait until an image is stopped on the monitor screen before performing a button operation, or hold down the button until the image stops.
 - Images copied from another digital camera or a computer may take longer time to appear than the Slide Show interval time you select.
- 
- 

DELETING IMAGES

You can use either of two options to delete images, SELECT or ALL.





| To do this: | Select this option: |
|--|---------------------|
| Select the currently displayed image | SELECT |
| Delete all images that are not protected | ALL |

IMPORTANT!

- Image deletion cannot be undone. Before deleting an image, make sure you no longer need it or you have a back-up copy saved on your computer, on diskette, or on some other medium. Be especially careful with the "Deleting All Unprotected Images" operation, which deletes all unprotected images in memory.
- A protected image cannot be deleted. See "Protecting Images Against Deletion" on page 55 for details on protecting and unprotecting images.
- Delete operations are disabled when all of the images on the camera's memory card are protected.

Deleting a Single Image

Perform the following steps when you want to delete a single specific image.

1. Align the mode selector with .
2. Press MENU.
3. Use [▲] and [▼] to select "DELETE" and then press SET .
4. Use [▲] and [▼] to select "SELECT" and then press SET .
5. Use [▲] and [▼] to select the operation you want to perform, and then press SET .



DELETING IMAGES

| To do this: | Select this option: |
|--------------------------------------|---------------------|
| Exit the image selection screen | EXIT |
| Delete the currently displayed image | DELETE |
| Scroll forward to the next image | NEXT |
| Scroll back to the previous image | BACK |

6. When the image you want is displayed, use [▲] and [▼] to select “DELETE” and then press SET ⚡.
7. In response to the confirmation message that appears, use [▲] and [▼] to select “YES” and then press SET ⚡.
 - If you change your mind and do not want to delete the image, select “CANCEL” and then press SET ⚡.
8. To exit the image delete procedure, press MENU.

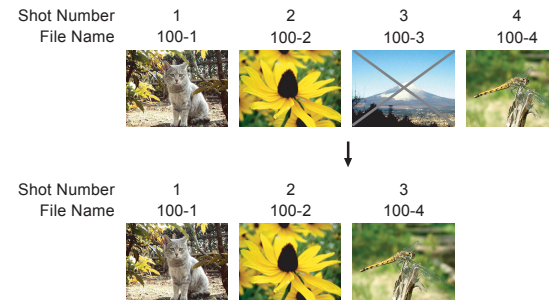

NOTE

- The camera does not maintain open spaces in its memory. Deleting an image causes images following the deleted image to be shifted up to fill in the empty space. Note, however, that file names are not changed.



Deleting All Unprotected Images

The following procedure deletes all unprotected images currently in memory.

1. Align the mode selector with .
2. Press MENU.
3. Use [▲] and [▼] to select "DELETE" and then press SET .
4. Use [▲] and [▼] to select "ALL" and then press SET .
5. The remainder of this procedure is identical to steps 7 through 8 under "Deleting a Single Image" on previous page.

MANAGING IMAGES

The image management capabilities of the camera make it easy to keep track of images. You can protect images against deletion, and even use its DPOF feature to specify images for printing.

Folders and Files

Your camera automatically creates a directory of folders in its built-in flash memory or on the memory card to store images.

Folders

A folder is created automatically whenever you shoot the first image on a particular date. The name assigned to the folder is based on the current date, as described below. You can have up to 900 folders on a memory card at the same time (subject to storage capacity restrictions).

Example: Folder created on July 19, which is the 100th folder on the memory card

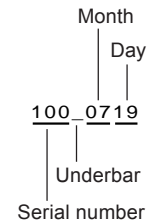

- The actual number of folders you will be able to store on a memory card depends on the capacity of the card, image quality settings, etc.

Files

Each folder can contain up to 9,999 image files. If you try to save the 10,000th image to a folder, the camera automatically creates a new folder and stores the image there. The names assigned to files are based on the current date, as shown below.

Example: 26th image shot on November 7



Month
Day
11070026.JPG
Serial number Extension

■ The actual number of files you will be able to store on a memory card depends on the capacity of the card, image quality settings, etc.

Protecting Images Against Deletion

Image protection guards against accidental deletion of images stored on the camera's memory card. A protected image cannot be deleted until it is unprotected (page 51). You can protect and unprotect a single specific image or all images currently on the memory card.

To protect or unprotect a single image

1. Align the mode selector with .
2. Press MENU.
3. Use [▲] and [▼] to select "PROTECT" and then press SET .
4. Use [▲] and [▼] to select "SELECT" and then press SET .

MANAGING IMAGES



5. Use [▲] and [▼] to select the operation you want to perform, and then press SET ⚡.



| To do this: | Select this option: |
|---|---------------------|
| Exit the image selection screen | EXIT |
| Protect the currently displayed image | ON |
| Unprotect the currently displayed image | OFF |
| Scroll forward to the next image | NEXT |
| Scroll back to the previous image | BACK |





6. When the image you want to protect or unprotect is displayed, use [▲] and [▼] to select “ON” (protect) or “OFF” (unprotect) and then press SET ⚡.



- A protected image is indicated by the  icon. An unprotected image does not have a  displayed with it.

7. To exit the image protect procedure, press MENU.

To protect or unprotect all images

1. Align the mode selector with .
2. Press MENU.
3. Use [▲] and [▼] to select "PROTECT" and then press SET .
4. Use [▲] and [▼] to select "ALL" and then press SET .
5. Use [▲] and [▼] to select "ON" (protect) or "OFF" (unprotect) and then press SET .
6. To exit the image protect procedure, press MENU.

MANAGING IMAGES

DPOF



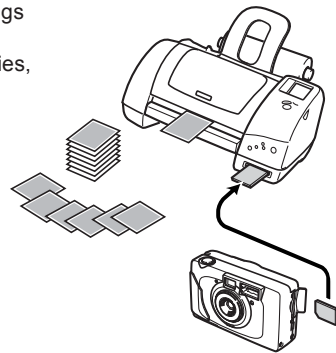

The letters “DPOF” stand for “Digital Print Order Format”, which is a format for recording on a memory card or other medium which digital camera images should be printed and how many copies of the image should be printed. Then you can print on a DPOF-compatible printer or at a professional print service from the memory card in accordance with the file name and number of copies settings recorded on the card.

With this camera, you should always select images by viewing them on the monitor screen. Do not specify images by file name without viewing the file contents.

■ DPOF Settings
File Name,
number of copies,
date



To print selected images

1. Align the mode selector with .
2. Press MENU.
3. Use [▲] and [▼] to select “DPOF” and then press SET .
4. Use [▲] and [▼] to select “SELECT” and then press SET .
5. Use [▲] and [▼] to select the operation you want to perform, and then press SET .



MANAGING IMAGES

| To do this: | Select this option: |
|--|---------------------|
| Exit the image selection screen | EXIT |
| Specify the number of copies to be printed | COPIES |
| Insert a date stamp into the image | DATE |
| Scroll forward to the next image | NEXT |
| Scroll back to the previous image | BACK |

- To set the number of prints of an image, use [▲] and [▼] to select “COPIES” and then press SET ⚡.
- Use [▲] and [▼] to specify the number of prints and then press SET ⚡.



- You can specify from 1 to 99 prints. Specify 0 if you do not want to have the image printed.

- To configure the date stamp setting, use [▲] and [▼] to select “DATE” and then press SET ⚡.
- Use [▲] and [▼] to select the option you want, and then press SET ⚡.

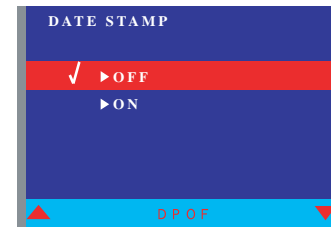





| To do this: | Select this option: |
|------------------------|---------------------|
| Turn on date stamping | ON |
| Turn off date stamping | OFF |

- To exit the print setting configuration procedure, press MENU.

MANAGING IMAGES

To print all images

1. Align the mode selector with .
2. Press MENU.
3. Use [▲] and [▼] to select “DPOF” and then press SET .
4. Use [▲] and [▼] to select “ALL” and then press SET .
5. Use [▲] and [▼] to specify the number of prints and then press SET .

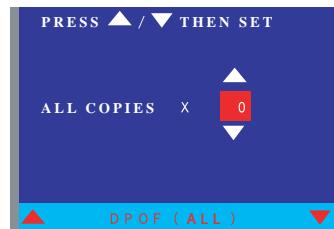

- You can specify from 1 to 99 prints. Specify 0 to turn off all image printing.
- Specifying 0 exits the print setting configuration procedure and returns to the menu screen.

6. Use [▲] and [▼] to select the option you want, and then press SET .

| To do this: | Select this option: |
|------------------------|---------------------|
| Turn on date stamping | ON |
| Turn off date stamping | OFF |

7. To exit the print setting configuration procedure, press MENU.

▶▶ IMPORTANT! ◀◀

- DPOF print settings can be configured for images on a memory card only, not for images in the camera's built-in memory. To configure DPOF print settings for images in camera memory, you first need to copy the images to a memory card.

PRINT Image Matching

This camera supports PRINT Image Matching, which means that images recorded with it include information about the mode settings, camera setup, etc. When you print an image on a printer that supports PRINT Image Matching, the printer reads this data and adjusts the printed image accordingly, so your images come out just the way you intended when you recorded them. See the documentation that came with your printer for full details about PRINT Image Matching.







* PRINT Image Matching is a term for the print command that is embedded in header file of the image created by Digital Camera. It contains color setting and image parameter information.

* SEIKO EPSON Corporation holds the copyright for PRINT Image Matching Version 1.0.

OTHER SETTINGS

Turning the Monitor Screen Indicators On and Off

You can use the following procedure to turn the monitor screen indicators (page 14) on and off.

1. Align the mode selector with  LCD or .
2. Press MENU.
3. Use [▲] and [▼] to select “INFO DISPLAY” and then press SET .
4. Use [▲] and [▼] to select the setting you want and then press SET .







| To do this: | Select this setting: |
|--|----------------------|
| Turn the monitor screen indicators on (displayed) | ON |
| Turn the monitor screen indicators off (not displayed) | OFF |

5. Press MENU or select “EXIT” and then press SET .

62

Changing the Display Language

You can use the following procedure to select either English or Japanese as the display language.

1. Align the mode selector with  LCD or .
2. Press MENU.
3. If you aligned the mode selector with  LCD in step 1, use [▲] and [▼] to select “SET UP” and then press SET .
 - If you aligned the mode selector with , skip step 3.
4. Use [▲] and [▼] to select “SET UP (BASIC)” and then press SET .
5. Use [▲] and [▼] to select “LANGUAGE/言語” and then press SET .





6. Use [▲] and [▼] to select the language you want and then press SET ⚡.

| To specify this display language: | Select: |
|-----------------------------------|---------|
| English | ENGLISH |
| Simple Chinese | 中国語 |

7. Press MENU.

Turning the Confirmation Tone On and Off

Perform the following steps to turn the button confirmation tone on and off.

1. Align the mode selector with  LCD or .
2. Press MENU.
3. If you aligned the mode selector with  LCD in step 1, use [▲] and [▼] to select “SET UP” and then press SET ⚡.
 - If you aligned the mode selector with , skip step 3.
4. Use [▲] and [▼] to select “SET UP (BASIC)” and then press SET ⚡.
5. Use [▲] and [▼] to select “BEEP” and then press SET ⚡.

OTHER SETTINGS







6. Select the setting you want and then press SET .

| To do this: | Select this setting: |
|---|----------------------|
| Turn the confirmation tone on (sounds) | ON |
| Turn the confirmation tone off (does not sound) | OFF |

7. Press MENU.

Selecting the USB Mode

The USB port of your camera supports both mass storage class and image class. Use the following procedure to select the mode that suits the type of USB connection you need.

1. Align the mode selector with  LCD or .
2. Press MENU.
3. If you aligned the mode selector with  LCD in step 1, use [▲] and [▼] to select “SET UP” and then press SET .
 - If you aligned the mode selector with , skip step 3.
4. Use [▲] and [▼] to select “SET UP (BASIC)” and then press SET .
5. Use [▲] and [▼] to select “USB MODE” and then press SET .

6. Use [▲] and [▼] to select the setting you want and then press SET ⚡.

| To do this: | Select this setting: |
|--|----------------------|
| Save images you record on a computer hard disk (mass storage class, page 68) | NORMAL |
| Use the camera as a PC camera for video conferencing (image class, page 74) | PC CAMERA |

7. Press MENU.

▶▶ IMPORTANT! ▶▶

- Use the AC adaptor to power the camera whenever transferring data over a USB connection.

CONNECTING TO EXTERNAL EQUIPMENT

Your camera has two terminals for connecting to external equipment: a VIDEO OUT terminal and a USB port. You can use these terminals to connect the camera to a television, VCR, or computer.

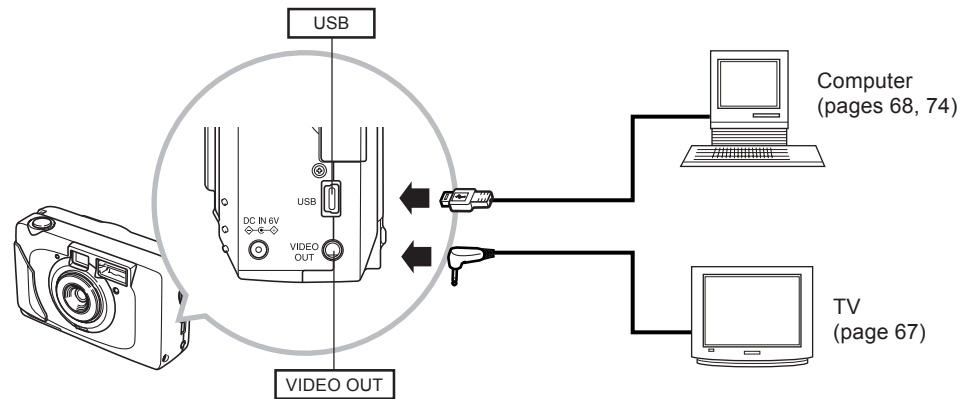

▶▶ IMPORTANT! ◀◀

- Be sure to turn off both the camera and the other equipment before making any connections.
- Check the documentation that comes with your other equipment for information you may need to know when making connections.
- Leaving the same image displayed on a television or computer display screen for very long periods can cause the image to be "burned in" on the screen. When this happens, a faint after-image remains on the screen, even after you disconnect the camera. To avoid this, you should not leave the same image displayed on such a screen for very long periods.
- This camera does not support cable transfer of data with other digital cameras.

CONNECTING TO EXTERNAL EQUIPMENT

Connecting to a Television

Images being displayed on the camera's monitor screen, whether for recording or playback can also be displayed on the screen of a connected television. Connect the camera to a TV as illustrated below.

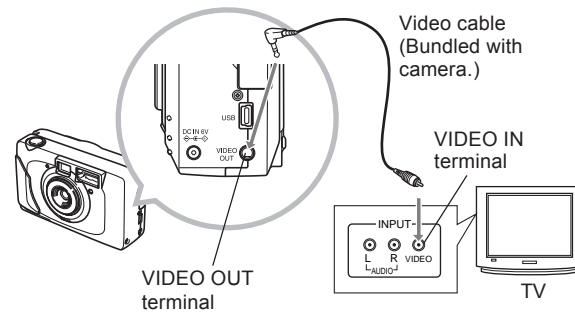

1. Use the video cable to connect the camera to the television as shown in the illustration.
2. Perform the required operation on the TV to set it up for video input.
¥ See the documentation that comes with your television for information about how to do this.
3. Perform normal playback and recording operations on the camera.









▶▶ IMPORTANT! ◀◀

¥ The monitor screen turns off automatically during video output.

Selecting the Video Output Signal Mode

Your camera supports both NTSC (used in U.S., Japan, and other countries) and PAL (used in Europe and other areas) video output signal systems. The video system you should use depends on the country of origin of the equipment you are connecting to the camera's VIDEO OUT terminal.

CONNECTING TO EXTERNAL EQUIPMENT

1. Align the mode selector with  LCD or .
2. Press MENU.
3. If you aligned the mode selector with  LCD in step 1, use [▲] and [▼] to select "SET UP" and then press SET 
 - If you aligned the mode selector with , skip step 3.
4. Use [▲] and [▼] to select "SET UP (BASIC)" and then press SET .
5. Use [▲] and [▼] to select "VIDEO OUT" and then press SET .
6. Use [▲] and [▼] to select "NTSC" or "PAL" and then press SET .
7. Press MENU.

Transferring Images to a Computer

The CD-ROM that comes bundled with your camera contains a copy of Photo Loader, which is an application that lets you transfer the contents of the camera's memory to your computer quickly and easily. You can connect to a computer that is equipped with a USB port. You can also transfer images using the memory card, if your computer is equipped to read memory cards.

USB Connection

If your computer has a USB port, you can connect it to the camera's USB port for quick and easy image data transfer. Use the USB cable that comes with the camera to connect to a computer.

The first time you connect to your computer, you will need to install the USB driver. After that, the camera becomes a peripheral (card reader/writer) recognized by your computer whenever they are connected.

CONNECTING TO EXTERNAL EQUIPMENT

Connecting the USB Cable

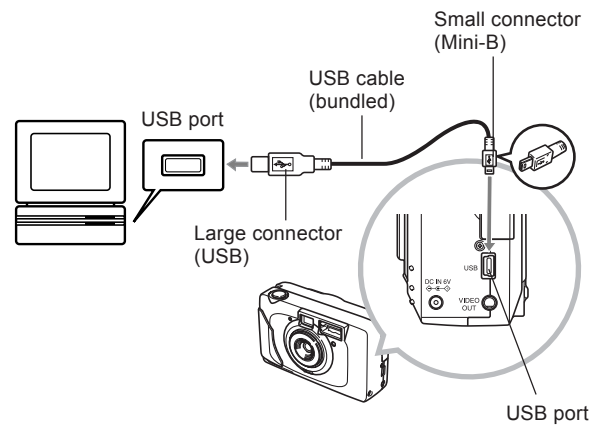

- Take care when connecting the USB cable to the camera. The USB port and the cable plug are shaped for proper positioning, so make sure you position the plug correctly when inserting it into the port.
- Plug the USB cable into the ports securely as far as it will go. Proper operation is not possible if connections are not correct.
- The camera does not draw power over the USB cable. After connecting the cable, turn on the camera.
- Always use the optional AC adaptor to power the camera whenever performing data communication with a computer. Low battery power can cause the camera to power down suddenly during data communication.
- Never disconnect the USB cable while data communication is in progress. Doing so can cause data to become corrupted.
- You can perform data communication in either the REC mode or PLAY mode.

CONNECTING TO EXTERNAL EQUIPMENT

Disconnecting the USB Cable

- Windows XP, Windows Me or 98
Disconnect the USB cable from the camera, and then turn off the camera.
- Windows 2000
Click card services in the task tray on your computer screen, and disable the drive number assigned to the camera. Next, disconnect the USB cable from the camera, and then turn off the camera.
- Macintosh
In Finder, drag the camera to the trash can. Next, disconnect the USB cable from the camera and then turn off the camera.
- After completing data communication over a USB connection, use one of the prescribed procedures above to disconnect the USB cable.
- You cannot turn off the camera while the USB cable is connected. Disconnect the USB cable before turning off the camera.

Using a Memory Card to Transfer Image Data

In addition to the cable connections described in the previous sections, you can also exchange data between your camera and computer by reading it directly from the memory card. The Photo Loader software that comes on the bundled CD-ROM disc automatically reads the images from the memory card and stores them in folders on your computer's hard disk.

The following provides general information about how to directly read images from a memory card. Certain details may be different depending on the type of computer you are using.

- Computer equipped with an SD memory card slot
Insert the SD memory card directly into the slot.
- Computer equipped with a PC card slot
Use a commercially available PC card adapter (for an SD memory card/MMC). For full details, see the user documentation that comes with the PC card adapter and your computer.

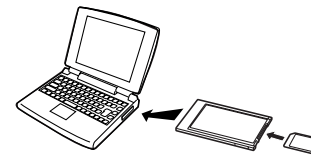

CONNECTING TO EXTERNAL EQUIPMENT

■ Other types of computers

Use a commercially available SD memory card reader/writer.

See the user documentation that comes with the SD memory card reader/writer for details about how to use it.

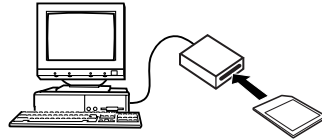

Use a commercially available PC card reader/writer in combination with a commercially available PC card adapter (for an SD memory card/MMC).

See the user documentation that comes with the PC card reader/writer and PC card adapter (for an SD memory card/MMC) for details about how to use them.

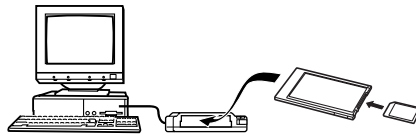

Memory Card Data

Images recorded with this camera and other data are stored on the memory card using DCF (Design rule for Camera File system) protocol. DCF protocol is designed to make it easier to exchange image and other data between digital cameras and other devices.

DCF Protocol

DCF devices (digital cameras, printers, etc.) can exchange images with each other. DCF protocol defines the format for image file data and the directory structure for the memory card, so images can be viewed using another manufacturer's DCF camera or printed on a DCF printer. In addition to support for the DCF protocol, your digital camera also uses dates in image folder names and image file names, which helps to make data management easier.

CONNECTING TO EXTERNAL EQUIPMENT

Memory Card File Structure

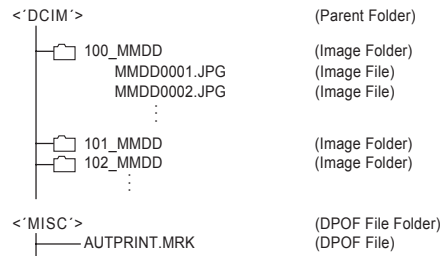

- Folder and File Contents
- Parent Folder
Contents: All files used by the digital camera
- Management File
Contents: Information about folder management, image sequence, etc.
- Image Folder
Contents: Image files recorded by the camera
- Image File
Contents: Still image file recorded by the camera
- DPOF File Folder
Contents: DPOF files

72

Image Files Supported by the Camera

- Image files recorded with the Digital Camera
- DCF protocol image files

Certain DCF functions may not be supported. When displaying an image recorded on another camera model, it may take a long time for the image to appear on the display.

Precautions when Using a Memory Card on a Computer

- Note that the folder named "DCIM" is the parent (top) folder of all the files on a memory card. When transferring memory card contents to a hard disk, MO disk, or other external storage, treat all the contents inside a DCIM folder as a set and always keep them together. You can change the name of the DCIM folder on your computer. Changing the name to a date is a good way to keep track of multiple DCIM folders. However, be sure you change the name of the DCIM folder back to "DCIM" before you copy it back to a memory card for playback on the camera. The camera does not recognize any folder name other than DCIM.
- The above is also true about the names of folders inside the DCIM folder. These folders must be returned to the names assigned to them by the camera whenever you copy the folder back to the memory card for playback on the camera.

- We also strongly recommend that after transferring data from a memory card to other external storage you reformat the memory card and delete its contents before using it to record more images.

CONNECTING TO EXTERNAL EQUIPMENT

Using the PC Camera Mode

You can connect your camera to a PC and use it as a PC camera for video conferencing, Web chatting, etc.



▶▶ IMPORTANT! ◀◀

- The PC camera Mode operation is not supported for the Apple Macintosh.

To connect the camera as a PC camera

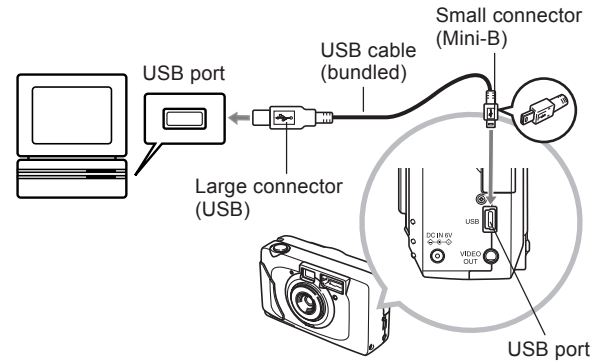
1. Turn off your PC and the camera.
2. Use the bundled USB cable to connect the camera's USB port to the USB port of your computer.



3. Slide the POWER ON/OFF switch to the right to turn on the camera.
4. Align the mode selector with  LCD or  FINDER.

You cannot use the PC Camera Mode while the mode selector is aligned with  (PLAY).

- All camera buttons are disabled in the PC Camera Mode, including the POWER ON/OFF switch.
- The monitor screen turns off, and the operation lamp lights green.

Other Requirements

You also need to obtain and install video conferencing software in order to use the camera as a PC camera. Following is the name of a typical video conferencing application.

Application Name: Microsoft NetMeeting

In addition, video conferencing also requires network devices such as a modem and terminal adapter, as well as speakers, microphone, etc.

PC Camera Mode Precautions

- This camera is not supplied power from your computer over the USB cable. The camera must be supplied power from its own power supply.
- Make image size and frame rate settings on your computer.
- See the user documentation that comes with the PC camera application you use for information about whether you can save PC camera still images and movies.

Connecting to Your Computer

- Make sure you install the USB driver that comes on the bundled CD-ROM first. See the "Installation guide" for information about installing the driver.
- After installing and configuring your PC camera application, connect to your computer using the procedures provided on page 69 of this manual.
- Use the procedures described in the documentation that comes with your PC camera application to perform PC camera operations.

▶▶ IMPORTANT! ◀◀

- The PC Camera Mode of this camera may not be compatible with certain computers.
- Operation is not guaranteed when the camera is connected to USB hub or expansion USB board.

REFERENCE

Camera Menu

The following shows lists of menus that appear in the REC mode and PLAY mode, and their settings.

- The settings that are underlined in the following table are initial defaults.

REC mode

| | |
|--------------------|--|
| EXIT | |
| WHITE BALANCE | AUTO / DAYLIGHT / SHADE / TUNGSTEN / FLUORESCENT |
| EXPOSURE | -2EV to +2EV |
| INFO DISPLAY | OFF / ON |
| SELF TIMER | OFF / 10 sec / 2 sec |
| DRIVE MODE | SINGLE / CONTINUOUS |
| SIZE | L1600 x 1200 / S800 x 600 |
| QUALITY | FINE / NORMAL |
| FORMAT | NO / YES, FORMAT |
| SET UP EXIT | |
| CONTINUOUS | 2 to 5 shots (3 shots) |
| SHOT NO. | |
| SHOT REVIEW | OFF / ON |

| | |
|--------------------------------|--------------------|
| SET UP (BASIC) USB MODE | NORMAL / PC CAMERA |
| BEEP | OFF / ON |
| DATE & TIME | Time setting |
| VIDEO OUT | NTSC / PAL |
| LANGUAGE/言語 | ENGLISH / 中国語 |

PLAY mode

| | |
|--------------------------------|---------------------|
| EXIT | |
| ZOOM | |
| DELETE | EXIT / SELECT / ALL |
| INFO DISPLAY | ON / OFF |
| COPY TO CARD | |
| PROTECT | EXIT / SELECT / ALL |
| SLIDE SHOW | |
| DPOF | EXIT / SELECT / ALL |
| FORMAT | NO / YES, FORMAT |
| SET UP (BASIC) USB MODE | NORMAL / PC CAMERA |
| BEEP | OFF / ON |
| DATE & TIME | Time setting |
| VIDEO OUT | NTSC / PAL |
| LANGUAGE/言語 | ENGLISH / 中国語 |

Indicator Lamp Reference

The camera has three indicator lamps, an operation lamp, a card access lamp, and a self-timer lamp. These lamps light and flash to indicate the current operational status of the camera.

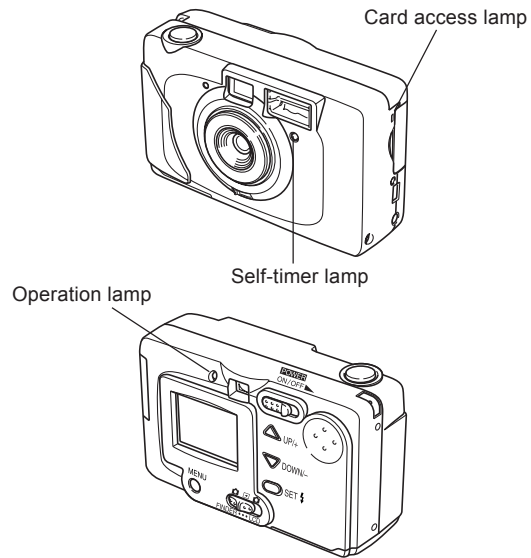

A lamp can flash using one of the three flash patterns illustrated below. You can recognize a flash pattern by watching how many times per second the lamp flashes.

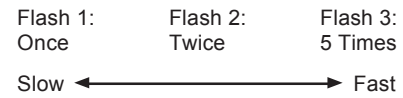

REFERENCE

REC mode

The card access lamp lights or flashes only while a memory card is loaded in the camera.

| Operation Lamp | | Card Access Lamp | | Self-Timer Lamp | | Meaning |
|----------------|------------|------------------|---------|-----------------|------------|--------------------------------------|
| Color | Status | Color | Status | Color | Status | |
| Green | Flash 3 | Green | Flash 3 | | | Starting up |
| Amber | Flash 1 | | | | | Flash charging |
| Amber | On | | | | | Flash will fire |
| Green | On | | | | | PC Camera Mode |
| Green | On | | | | | Ready to record snapshot |
| Green | On | Green | Flash 3 | | | Storing snapshot (ready to record) |
| Green | Flash 3 | Green | Flash 3 | | | Storing snapshot (record disabled) |
| Green | On | | | | | Ready to record continuous |
| Green | Flash 3 | Green | Flash 3 | | | Storing continuous (record disabled) |
| Green | Flash 1, 2 | | | Red | Flash 1, 2 | Self-timer countdown (10 - 2) |
| Green | Flash 3 | | | Red | Flash 3 | Self-timer countdown (2 - 0) |
| Red | Flash 3 | | | | | Memory error, not formatted |
| Red | Flash 3 | | | | | Memory full |
| Red | Flash 3 | | | | | Image store error |
| Red | Flash 3 | | | | | Low battery warning |
| | | Green | Flash 1 | | | Sleep |







PLAY mode

The card access lamp lights or flashes only while a memory card is loaded in the camera.

| Operation Lamp | | Card Access Lamp | | Self-Timer Lamp | | Meaning |
|----------------|---------|------------------|---------|-----------------|--------|-----------------------------|
| Color | Status | Color | Status | Color | Status | |
| Green | Flash 3 | Green | Flash 3 | | | Starting up |
| Green | On | Green | Flash 3 | | | Normal playback |
| Green | Flash 3 | Green | Flash 3 | | | Deleting image |
| Green | Flash 3 | Green | Flash 3 | | | Configuring DPOF settings |
| Green | Flash 3 | Green | Flash 3 | | | Formatting card |
| Red | Flash 3 | | | | | Memory error, not formatted |
| Red | Flash 3 | | | | | Low battery warning |

REFERENCE



Troubleshooting

| | Problem | Possible Cause | Action |
|-----------|---|--|--|
| Power | Power does not turn on. | <ol style="list-style-type: none"> 1. Batteries are not oriented correctly. 2. Batteries are dead. 3. Wrong AC adaptor type being used. | <ol style="list-style-type: none"> 1. Orient batteries correctly (page 18). 2. Replace batteries (page 18). 3. Use only an AD-C620 AC adaptor. |
| | Camera suddenly powers down. | <ol style="list-style-type: none"> 1. Auto Power Function activated (page 24). 2. Batteries are dead. | <ol style="list-style-type: none"> 1. Turn power back on. 2. Replace batteries (page 18). |
| Recording | Image is not recorded when the shutter release button is pressed. | <ol style="list-style-type: none"> 1. Mode selector is aligned with . 2. Flash unit is being charged. 3. Memory is full. | <ol style="list-style-type: none"> 1. Set the mode selector to . 2. Wait until flash unit charging finishes. 3. Delete images you no longer need, or use a different memory card. |
| | Digital zoom does not work. | The image size setting is "S 800 x 600." | Change the image size setting to "L 1600 x 1200" (page 39). |
| | Camera powers down during self-timer countdown. | Batteries are dead. | Replace batteries (page 18). |
| | Monitor screen image is out of focus. | <ol style="list-style-type: none"> 1. Macro Mode  being used for scenery or portraits. 2. Normal Mode  being used for macro image. | <ol style="list-style-type: none"> 1. Set the Normal/Macro selector to  (Normal) for scenery and portraits. 2. Set the Normal/Macro selector to  (Macro) for macro images. |
| | Recorded images are not saved in memory. | <ol style="list-style-type: none"> 1. Camera powers down before the save operation is complete. 2. Removing the memory card before the save operation is complete. | <ol style="list-style-type: none"> 1. If the  indicator is on the monitor screen, replace batteries with a full set of new ones as soon as possible. 2. Do not remove the memory card before the save operation is complete. |

REFERENCE

| | Problem | Possible Cause | Action |
|----------|---|---|--|
| Playback | Color of the playback image is different from the image on the monitor screen during recording. | Sunlight or light from another source is shining directly into the lens during recording. | Position the camera so sunlight does not shine directly into the lens. |
| | Images are not displayed. | A memory card with non-DCF images recorded with another camera is loaded in the camera. | This camera cannot display non-DCF images recorded onto a memory card using another digital camera. |
| | Monitor screen contents do not appear on the screen of a connected television. | <ol style="list-style-type: none"> 1. There is a problem with the camera-TV connection. 2. TV setup is wrong. 3. Video system is incompatible. | <ol style="list-style-type: none"> 1. Use the special video cable to connect the camera to the TV correctly (page 67). 2. Consult the documentation of the TV and put it in its video mode. 3. Select the proper video output system (page 67). |
| Deleting | The image selection screen does not appear when DELETE is selected. | All the images in memory are protected. | Unprotect the images you want to delete (page 55). |

REFERENCE

| | Problem | Possible Cause | Action |
|-------|---|--|--|
| Other | All buttons and switches are disabled. | Circuit problem caused by electrostatic charge, impact, etc. while the camera was connected to another device. | Remove the camera's batteries, disconnect the AC adaptor, replace the batteries, and turn on power again. |
| | Monitor screen is off. | <ol style="list-style-type: none"> 1. Sleep mode activated. 2. USB cable is connected. 3. Video cable is connected to the camera. 4. Mode selector is set to  FINDER. | <ol style="list-style-type: none"> 1. Press any button to recover from the sleep mode (page 24). 2. After confirming that the computer is not accessing the memory card, disconnect the USB cable. 3. Disconnect the video cable. 4. Set the mode selector to  LCD. |
| | Cannot transfer images or perform PC camera operations after connecting to a computer with the USB cable. | <ol style="list-style-type: none"> 1. Wrong USB mode is selected. 2. USB driver is not installed. 3. Camera is turned off. | <ol style="list-style-type: none"> 1. Select the USB mode that suits the operation you are trying to perform (page 64). 2. Install the USB driver in accordance with the "Installation guide". 3. Turn on the camera (page 23). |

Display Messages

| | |
|---|--|
| ERROR | This message appears in the rare case that an image is so complex that its file cannot be compressed to the maximum allowable size. |
| NOT AVAILABLE FOR THIS IMAGE | The displayed image was recorded on another type of camera and cannot be enlarged. |
| CARD IS WRITE-PROTECTED SLIDE THE LOCK-SW | The LOCK switch on the SD memory card is in the locked position, so the card cannot be accessed in the REC mode. |
| COPY ERROR NOT ENOUGH MEMORY IN CARD | Amount of memory available on the memory card is less than the data being copied to it. |
| REPLACE BATTERY! | Battery power is low. |
| NOT AVAILABLE FOR INTERNAL MEMORY | You are trying to configure DPOF settings for camera memory. DPOF settings can be configured for the memory card only (Page 58). |
| CARD ERROR PRESS MENU TO FORMAT or INTERNAL MEMORY ERROR PRESS MENU TO FORMAT | Some problem occurred with the memory card or built-in memory. Perform the following steps to correct it.))) IMPORTANT! (((Performing this procedure deletes all files on the memory card or built-in memory. Before proceeding, try transferring recoverable files to a computer or some other storage device. |

1. Press MENU.
2. Use [▲] and [▼] to select "YES" and then press the shutter release button.
 - If you want to cancel the procedure, press MENU without selecting "YES".
 - Before starting a format operation, connect the AC adaptor for power or load a full set of fresh set of alkaline or lithium batteries. Power interruption during the format operation can result in improper formatting, and even damage the memory card or built-in memory and make it unusable.
 - The message "NO IMAGE" appears on the monitor screen after the format operation is complete. This indicates that the format operation was completed successfully.

**MEMORY FULL
CHANGE QUALITY/
SIZE OR DELETE** No more images can be stored under the current image quality and size settings, but further recording is possible with different settings. Change the image quality and size settings (page 39), or delete images you no longer need (page 51).



**MEMORY FULL
DELETE UNNEEDED
IMAGES**

- Memory is full. If you want to record more images, delete images you no longer need (page 51).
- This message also appears after data is transferred to a memory card from a computer when a DCIM folder or other required files (page 72) cannot be created because there is not enough memory card space. Use your computer to free up space by deleting files you no longer need. You can press MENU to format the memory card, but doing so deletes all data stored on the card.



REFERENCE

| | |
|---|--|
| NOT ENOUGH MEMORY FOR CONTINUOUS SHOT CANNOT TAKE ALL | Due to the type of subject you are shooting, five Consecutive Shutter Mode shots cannot be recorded. |
|---|--|

| | |
|--|---|
|  SELECT | You are trying to use the viewfinder to shoot in the macro mode. Slide the mode selector to  LCD and use the monitor screen for macro shots. |
|  LCD | |
| CHANGE MODE! | |

Specifications

Description Digital camera

Recorded Image
 File Format Still images: JPEG (Exif. Ver. 2.1) / DCF standard (Design rule for Camera File system), DPOF compatible

Recording Medium Built-in 16MB flash memory
 SD Memory Card
 MultiMediaCard

Recorded Image Size 1600 x 1200 pixels, 800 x 600 pixels

Standard Memory Capacity, Number of Image Files, Computer Output Image Size

* The number of image values marked with an asterisk is based on the SD

| Image size (pixels) | Quality | File size | Still | |
|---------------------|---------|--------------|----------------------------|---------------------|
| | | | Number of images | |
| | | | Built-in flash memory 16MB | SD Memory Card 64MB |
| 1600 x 1200 | FINE | 850 KB/image | 16 | 62* |
| | NORMAL | 600 KB/image | 23 | 88* |
| 800 x 600 | FINE | 200 KB/image | 67 | 258* |
| | NORMAL | 150 KB/image | 92 | 352* |

memory card made by Matsushita Electric Industrial Co.,Ltd. The actual number of images depends on the brand of SD memory card you use.

Image Deletion Single image; all images in memory

(with image protection)

Effective Pixels 2 million

Imaging Element CCD (Total Pixels: 2.14 million)

Lens F3.3; f = 6.2mm (equivalent to 41mm lens for 35mm film)

Zoom Digital zoom: 2X
 Image size is 800 x 600 pixels when 2X digital zoom is used.

Focusing Fixed focus with macro mode

Focus Range Normal focus : 80cm to ∞(31.5" to ∞)
 Macro focus : 20cm (7.9")
 The focusing range is the distance from the lens surface to the subject.

Exposure Control
 Light Metering: Center-weighted by CCD
 Exposure: Program AE
 Exposure Compensation: -2EV to +2EV (1/3EV units)

Shutter CCD electronic shutter; mechanical shutter, 1/4 to 1/800 second

Aperture F3.3, F8, auto switching

White Balance Automatic, fixed (4 modes)

REFERENCE

| | |
|------------------------------|---|
| Self-timer | 10 seconds, 2 seconds |
| Built-in Flash | |
| Flash Modes: | AUTO, OFF, ON, Red-eye reduction |
| Flash Range: | Approximately 0.8 to 2 meters (2.6' to 6.6') |
| Recording Functions | Normal, continuous shutter, self-timer, macro |
| Monitor | 1.5" TFT color LCD (61,600 pixels, 280 x 220) |
| Viewfinder | LCD Monitor or optical viewfinder |
| Clock | Built-in quartz digital timepiece for time and date recording and storage with image data; auto calendar up to 2099 |
| Input/Output Terminals | USB port (Mini-B port), AC adaptor connector, VIDEO OUT (NTSC, PAL) |
| Power Supply | Four AA-size alkaline or lithium batteries Four AA-size nickel-metal hydride rechargeable batteries (NP-H3) AC adaptor (AD-C620) AC adaptor charger (BC-3HA) |

Battery Life

The values noted below indicate the number of hours before battery failure under normal operating temperature (25°C). These values are for reference only, and do not guarantee that any particular set of batteries actually will provide the service life indicated. Low temperatures shorten battery life.

| Type of Operation | AA-size Alkaline Batteries LR6 | AA-size Lithium Batteries FR6 | AA-size Ni-MH Batteries NP-H3 |
|----------------------|--------------------------------|-------------------------------|-------------------------------|
| Continuous Playback | 140 minutes | 300 minutes | 160 minutes |
| Continuous Recording | 120 minutes (720 shots) | 290 minutes (1740 shots) | 150 minutes (900 shots) |

- The above figures are approximations only.
- The above guidelines are based on the following battery types:
Alkaline: MX1500 (AA) DURACELL ULTRA
Lithium: Energizer

Continuous recording values show the number of shots without using the flash. The number of shots depends on use of the flash and whether flash is turned on or off.

CAUTION!

- Battery life differs greatly by manufacturer. We recommend use of MX 1500 (AA) DURACELL ULTRA alkaline batteries with this product.

Power Consumption Approximately 8.0W

Dimensions 108(W) x 67(H) x 44(D) mm
(4.3" (W) x 2.6" (H) x 1.7" (D))

Weight Approximately 190g (6.7 oz)
(excluding batteries)

Standard Accessories Strap; soft case; USB cable;
special video cable; CD-ROM;
four LR6 alkaline batteries;
User's Guide.

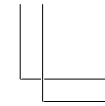
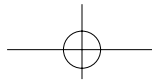
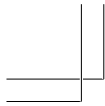

REFERENCE

- This camera does not have a separate battery to power its clock. Clock settings are cleared whenever power to the camera is cut off (by batteries going dead while the camera is not connected to an AC power outlet with the AC adaptor) for about 12 hours. After power is resumed, either by loading fresh batteries or connecting to an AC power outlet, you will have to set the correct date and time again.
- The liquid crystal panel built into this camera is the product of precision engineering, with a pixel yield of 99.99%. This also means, however that 0.01% of the pixels can be expected to fail to light or to remain lit at all times.

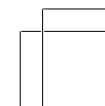
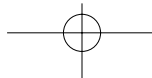
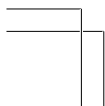
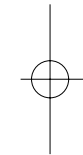
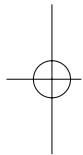

SOFTWARE DRIVER INSTALLATION GUIDE

Content of CD

For Windows98/2000/Me/XP

- Camera USB Driver
- NetMeeting
- MGI Photo Suite IV SE
- MGE Video Wave IV SE
- MGI Photo Vista 2.02
- Acrobat Reader
- Camera Manual

For Macintosh

- Camera USB Driver
- Acrobat Reader
- Camera Manual

Camera User Manual

You will see the User Manual of this camera by following steps.

1. Run File Manager
2. Find this camera CD ROM Drive and click it
3. Open "Manual" folder

Note

You have to install Acrobat Reader to read the manual.

Install the software and driver for windows PC

1. Install driver by Setup:

1. Power on your system, and do not plug the camera in .
2. Insert the installation CD, the setup program will automatically appear on the screen.

2.If the software install shield doesn't appear on your screen:

- 1.Select Run from the start menu
- 2.Enter D:\setup.exe("D" being your CD-ROM drive)
- 3.Click on OK
- 4.Select camera Driver & CAM- In Suite III to install Camera Driver<Necessary>
- 5.Select the software you like to use for running Camera:

● *MGI Video Wave 4 SE*

let user create, edit and produce low-bandwidth MPEG1,MPEG2,ASF and MP3 files. Voice users can create powerful video presentations quickly and easily.

● *MGI Photo Suite 4 SE*

let user share, browse and import images from internet and create seamless panoramas and special effects provide hours of fun.

- **Photo Vista 2.02**
with this software , user can connect all continuously shot photos together and make seamless panoramas science photos .
- **NetMeeting**
meet face to face with others over the internet .
Make files transferring more easily.

Install USB driver for Mac

Install the USB driver and connect the digital camera with computer

- 1.Switch off the digital camera. Quit all applications on your Macintosh.
- 2.Insert the CD-ROM provided into the CD-ROM drive.
- 3.Open the hard disk selected as a startup disk.
- 4.Open the "System folder" in the startup disk.
- 5.Open the "Extensions" folder in the startup disk.
- 6.Open the "USB Driver" folder in the CD-ROM.
- 7.Drag&drop the files, "VQ2101USBStorage" and "VQ2101USBStorageShim" in the "USB Driver" folder into the "Extensions" folder.
- 8.The installation is completed .Confirm that you have

"VQ2101USBStorage" file and "VQ2101USBStorageShim" file in the "Extensions" folder, and restart your Macintosh.

- 9.When the operating system has started up, connect the digital camera to the Macintosh with the USB cable.
- 10.Switch on the digital camera.connect the cable and switch on the digital camera.
- 11.From the next time, the memory card in the digital camera will be recognized as a drive simply by connecting the digital camera to the Macintosh.The shape of the icon displayed will vary depending on the Mac OS version.

Note

Uninstall the USB Driver

Delete "VQ2101USBStorage" file and "VQ2101USBStorageShim" file in the "Extensions" folder. The uninstallation process is now complete.

Loading Image by USB Cable

IMPORTANT! CAMERA MUST BE POWER ON

1. connect computer and camera by USB
2. Please connect camera with computer as below photo indicate:

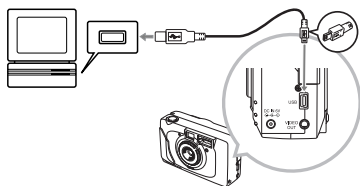

Loading images

There are two ways to load Photos from Camera to computer

1.) **By Mass Storage** :

Please ensure that your camera is set up in Mass Storage Mode before you Try to down load pictures from Camera to computer.

- a) Please press **MENU** button on camera and select **(SETUP)** then press **SET** button.
- b) Please select **(SETUP "BASIC")** and press **SET** button.
- c) Please select **(USB MODE)** and press **SET** button.
- d) Please select **(NORMAL)**
- e) After camera driver is fully installed in Computer , you'll find that in **(My Computer)**, a **(Removable Disk)** shows up which shows as **A1**.



A1

f) Double click this removable Disk and get your pictures which shows as **A2**.



A2

2) By Software : (from Photo Suite)

a) Choose the software – Photo Suite



b) Press **(Computer)** button



c) Choose **(Removable Disk)** and then select the photos which you'd like to download from Camera to computer.

