



User's Guide

B2520 MFP/B2540 MFP



Dear customer

For your security and comfort, we urge you to carefully read the **Safety** booklet before attempting use.

In buying this multifunction machine, you have opted for a quality product. Your device satisfies all of the different needs of a modern office automation tool.

This machine allows you to scan and fax in color and black and white, to print and copy in black and white. You can connect the multifunction device to your PC (Microsoft Windows 98SE/ME/2000SP3/XP).

Install the software included to use the multifunction device as a printer. Besides, you can scan, edit and save documents through your PC. If you have a WLAN adaptor (optional) you can communicate with a personal computer wirelessly.

WLAN is an optional working only with a specific adaptor that you can obtain from your retailer. You will find further information on our website.

Thanks to its navigator and its multitask access, it is powerful, user-friendly and easy to use.

The B2520 / B2540 multifunction machines, come with a 600 dpi scanner and a black and white laser printer offering a printing speed of 16 ppm. The Companion Suite Pro LL software provided allows you to use your multifunction machine as a scanner and a printer from a personal computer. It also gives you the ability to manage your multifunction machine.

Consumables

Refer to the Maintenance section of this booklet.

Lock the machine	28	<i>Mail sorting</i>	39
<i>Lock the keyboard</i>	28	F@X Only mode	39
<i>Lock the numbers</i>	28	PC Only mode	39
<i>Lock the SMS service</i>	29	Share PC mode	39
Read the counters	29	USB memory key	40
<i>Sent pages counter</i>	29	Use of the USB memory key	40
<i>Received pages counter</i>	29	<i>Print your documents</i>	40
<i>Scanned pages counter</i>	29	Print the list of files located in the key	40
<i>Printed pages counter</i>	29	Print the files located in the key	40
Display the consumables status	29	<i>Delete your files located in the key</i>	41
Calibrate your scanner	29	Analyse the USB memory key content	41
Directory	30	Save a document on a USB memory key	41
Creating subscribers record	30	PC Features	42
Creating subscribers list	30	Introduction	42
Modifying a record	30	Configuration requirements	42
Deleting a record or a list	31	Installation	42
Printing the directory	31	<i>Install the software on your PC</i>	42
Local network settings	32	<i>Connections</i>	44
Selecting the type of your local network	32	USB Connection	44
Ethernet network settings (Model B2540)	32	Network connection	44
<i>Automatic configuration</i>	32	<i>Uninstall the software from your PC</i>	45
<i>Manual configuration</i>	32	Multifunction Terminal's Supervision	46
IP address	32	<i>Checking the connection between the</i>	46
Sub-network mask	32	<i>PC and the multifunction machine</i>	46
Gateway address	32	MF Director	46
<i>IEEE Address (or Ethernet address) or</i>	32	<i>Graphical presentation</i>	46
<i>MAC address</i>	32	<i>Utilities and applications activation</i>	46
<i>NetBIOS names</i>	32	MF Monitor	47
<i>Serveurs de nom</i>	32	<i>Graphical presentation</i>	47
WLAN network	33	<i>Display the consumable status</i>	47
<i>Type of radio network</i>	33	<i>Scan To</i>	47
Radio infrastructure network	33	Companion Suite Pro LL functionalities	47
<i>Radio ad-hoc network</i>	33	<i>Document analysis</i>	47
<i>Radio networks (WLAN)</i>	33	Analysis with Scan To	47
<i>Connect your WLAN adaptor</i>	34	Analysis from a TWAIN compatible software	48
<i>Configure your network</i>	34	Character recognition software (OCR)	48
Creating or rejoining a network	34	<i>Printing</i>	48
<i>Referring to or changing your</i>	34	Printing with the multifunction machine	48
<i>network parameters</i>	34	Address book	49
An example of how an AD-HOC network	36	<i>Add a contact to the terminal address book</i>	49
may be set up	36	<i>Add a group to the terminal address book</i>	49
<i>Setting up a multifunction machine</i>	36	<i>Manage the address book</i>	50
Setting up the PC	36	Modify the information related to a contact	50
Message service (Model B2540)	37	Modify a group	50
Information required to set up message service	37	Delete a contact or a group from	50
Configuring initialisation parameters	37	the address book	50
<i>Access to servers parameters</i>	37	Print the address book	50
Access to SMTP authentication parameters	37	<i>Import or export a directory</i>	50
Sending an E-Mail	37	Import a directory	50
Sending an E-mail text	37	Save your address book	50
Scan to FTP	38	Fax communications	51
<i>Simply put the file in an FTP server</i>	38	<i>Presentation of the Fax window</i>	51
Connection configuration	38	<i>Send a fax</i>	51
<i>Standard settings</i>	38	Send a fax from the hard disk or the terminal	51
Selecting the connection type	38	Send a fax from application	52
Selecting the transmission type	38	<i>Receive a fax</i>	52
Modifying the connection	38	<i>Follow-up of fax communications</i>	52
period (Periodic type)	38	The outbox	52
Modifying the connection	38	The send memory (items sent)	52
time(s) (Set Times type)	38	The outbox log	53
Selecting the print mode	39	The inbox log	53
for the deposit notice	39	<i>Fax parameters</i>	53
Printing the Internet settings	39	Access to fax parameters	53
		Description of the tab Log and Report	53
		Description of the tab Fax Parameters	53

Cover sheet	54
Creating a cover sheet	54
Description of the tab Cover page	55
Creating a cover page template	55
SMS Communication	57
<i>Presentation of the SMS window</i>	57
<i>Send an SMS</i>	57
<i>Follow-up of SMS</i>	58
The outbox	58
The outbox log	58
The sent item memory (items sent)	58
<i>SMS Parameters</i>	58
Access to SMS parameters	58
Description of the tab Logs and reports	58
Maintenance	59
Service	59
<i>General information</i>	59
<i>Toner cartridge replacement</i>	59
<i>Issues with smart cards</i>	59
Cleaning	60
<i>Scanner reading system cleaning</i>	60
Printer cleaning	60
<i>Printer external cleaning</i>	60
Printer issues	60
<i>Error messages</i>	60
Paper jam	60
Scanner issues	61
Miscellaneous issues	61
Communication errors	61
<i>Transmission from the feeder</i>	62
<i>Transmission from memory</i>	62
<i>Communication error codes</i>	62
<i>General codes</i>	62
Specifications	63
<i>Physical specifications</i>	63
<i>Electrical specifications</i>	63
<i>Environmental specifications</i>	63
<i>Peripheral specifications</i>	63
<i>Consumable specifications</i>	64

Preface

Every effort has been made to ensure that the information in this document is complete, accurate, and up-to-date. Oki assumes no responsibility for the results of errors beyond its control. Oki also cannot guarantee that changes in software and equipment made by other manufacturers and referred to in this guide will not affect the applicability of the information in it. Mention of software products manufactured by other companies does not necessarily constitute endorsement by Oki.

While all reasonable efforts have been made to make this document as accurate and helpful as possible, we make no warranty of any kind, expressed or implied, as to the accuracy or completeness of the information contained herein.

The most up-to-date drivers and manuals are available from the Oki web site:
<http://www.okiprintingsolutions.com>

Copyright © 2006 Oki Europe Ltd.

Oki and Microline are registered trademarks of Oki Electric Industry Company, Ltd.

ENERGY STAR is a trademark of the United States Environmental Protection Agency.

Microsoft, MS-DOS and Windows are registered trademarks of Microsoft Corporation.

Other product names and brand names are registered trademarks or trademarks of their proprietors.



As an ENERGY STAR Program Participant, the manufacturer has determined that this product meets the ENERGY STAR guidelines for energy efficiency.



This product complies with the requirements of the Council Directives 89/336/EEC (EMC), 73/23/EEC (LVD) and 1999/5/EC (R&TTE), as amended where applicable on the approximation of the laws of the member states relating to Electromagnetic Compatibility, Low Voltage and Radio & Telecommunications Terminal Equipment.



Repairs/maintenance: Repairs and maintenance should only be carried out by a qualified technician. There are no user serviceable parts inside the machine. To reduce the risk of electrical shock, you must not carry out these operations yourself. Opening or removing the covers exposes you to two hazards:

- The laser beam can cause irreversible eye damage.
- Contact with electrical components can lead to electrical shock.

For installation conditions and safety precautions, refer to the separate Safety/Installation Instructions booklet provided.

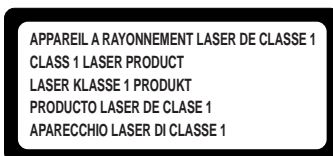

Environmental Information



Software use license

CAREFULLY READ ALL THE TERMS AND CONDITIONS OF THE PRESENT LICENSE BEFORE OPENING THE SEALED ENVELOPE CONTAINING THE SOFTWARE. OPENING THIS ENVELOPE INDICATES THAT YOU ACCEPT THESE TERMS AND CONDITIONS.

In case you should not accept the terms of this license, the CD-ROM packaging should be returned to the retailer unopened, along with the other components of the product. The purchase price of this product will be refunded. No refunds will be made for products if the CD-ROM packaging have been opened, if components are missing or if the reimbursement request is made after ten (10) days from the purchase date, your receipt is the proof of purchase.

Definition

The Software designates programs and associated documentation.

License

- This license allows you to use this Software on personal computers on a local network. You only have permission to use this Software to print on one multifunction machine; you can not lend the Software or authorize anyone to use it.
- You are allowed to make a back up copy.
- This license is non-exclusive and non-transferable.

Property

The manufacturer or its providers hold the Software property right. You only become the owner of the CD-ROM. You shall not modify, adapt, decompile, translate, create any derived piece, rent or sell the Software or the documentation. Any rights not explicitly approved are reserved by the manufacturer or its providers.

Duration

This license remains valid until cancelled. You can cancel it by destroying the program and the documentation as well as any other copies of them. This license will automatically be canceled in case you do not respect the terms of this license. If the license is rendered invalid, you agree to destroy all copies of the program and the associate documentation.

Warranty

The Software is provided "as is" with no warranties what so ever, whether expressed or implied, including without limitation, any warranties of merchantability or fitness for a particular purpose; all the risks concerning the results and performance of this Software are assumed by the buyer. In case the program should appear defective, all the repair and service expenses will be covered by the buyer.

Nevertheless, the license holder benefits from the following warranty: we guarantee that the CD-ROM on which the Software is recorded is free from hardware or manufacturing faults if used in normal conditions, the guarantee is valid for ninety (90) days from the delivery date, the copy of the receipt being the proof of purchase. In case of a CD-ROM fault that due to accident or misuse, the CD-ROM will not be replaced as per the warranty.

Responsibility

If the CD-ROM is not working properly, send it to the retailer together with a copy of the receipt. It is the retailer's sole responsibility to replace the CD-ROM. Nobody, not even the manufacturer who is involved in the creation, realization, merchantability and delivery of this program would be responsible for direct, indirect or immaterial damages, such as, but not limited to, loss of information, loss of time, execution loss, loss of revenue, loss of customers, due to the use or inability to use the program.

Development

With a constant concern for improvement, the manufacturer reserves the right to modify the Software specifications without any notice. In case of modification, your user right does not give you access to free updates.

Applicable law

This license is under the French law. Any dispute following the interpretation or execution of this license will be submitted to the Paris Court.

Given the continuous technology development, the manufacturer reserves the right to modify the technical specifications indicated for this product, at any time, without prior notice, and/or to stop manufacturing of the product. All the names of the products and brands that could be trademarks registered by their respective owners are recognized in the present document.

Registered trademarks

Adobe® and the Adobe® products referred to here are registered trademarks of Adobe Systems Incorporated.

PaperPort9SE is a registered trademark of ScanSoft.

Microsoft® Windows® 98, Microsoft® Windows® Millennium®, Microsoft® Windows NT®, Microsoft® Windows 2000®, Microsoft® Windows XP®, and any other Microsoft® product referred to here are registered trademarks of Microsoft Corporation registered and/or used in the United States and/or in other countries.

All the other brands or products referred to as examples or in order to give additional information are registered trademarks of their respective owners.

The informations contents of this user manual are subject to change without notice.

Prohibited reproductions

Do not copy or print any item for which reproduction is prohibited by law.

Copying or printing the following items is generally prohibited by local law :

- bank notes;
- checks;
- bonds;
- stock certificates;
- bank drafts;
- passports;
- driver's licenses.

The preceding list is meant as a guide only and is not inclusive. If you have any questions concerning the legality of copying or printing certain items, consult with your legal advisor.

Installation

Location conditions

By choosing an appropriate location, you preserve the longevity of the machine. Check that the selected location has the following characteristics:

- Choose a well ventilated location.
- Make sure not to obstruct the ventilation grids located on the left and right sides of the device. During the installation, make sure to place the machine thirty centimeters away from the surrounding objects so all the lids can be easily opened.
- Make sure that this location does not present any ammonia nor any other organic gasses emission hazard.
- The ground outlet (refer to the security notices presented in the **Safety** booklet) to which you plan to connect the machine must be located close to this one and have an easy access.
- **Make sure that the machine is not directly exposed to sun light.**
- Make sure not to place the machine in an area exposed to an air flow generated by an air conditioning, heating or ventilation system, nor in an area subject to large temperature or humidity variations.
- Choose a solid and horizontal surface on which the machine will not be exposed to intense vibrations.
- **Keep the machine away from any object that could obstruct its ventilation ports.**
- Do not place the machine close to hangings or any other flammable objects.
- Choose a location where splashes of the water and other liquids are limited.
- Make sure that this location is dry, clean and dust free.



Make sure to place the machine in well ventilated premises. When in operation, the printer generates a small amount of ozone. An unpleasant smell can come from the printer if it is used intensively in poorly ventilated premises. For a secure use, make sure you place the machine in well ventilated premises.

Cautions of use

Take into account the important precautions below when using the machine.

Running environment:

- Temperature: 10 °C to 32 °C with a maximum amplitude of 10 °C per hour.
- Humidity: 15 to 80 % of ambient humidity (without condensation), with a maximum amplitude of 20 % per hour.

Terminal:

The section below describes the precautions to be taken when using the machine:

- Never turn the machine off and never open the lids while printing.
- Never use gas or flammable liquids, or objects generating magnetic field close to the machine.
- When you unplug the power cord, always hold the connector without pulling the cord. A damaged cord presents a potential fire hazard or an electric shock hazard.
- Never touch the power cord with wet hands. You risk getting an electric shock.
- Always unplug the power cord before moving the machine. Otherwise, you could risk having the cord damaged and create a fire hazard or an electric shock hazard.
- Always unplug the power cord when you plan not to use the machine for a long period of time.
- Never put objects on the power cord, never pull it and never fold it. This could cause a fire hazard or an electric shock hazard.
- Always make sure that the machine is not sitting on the power cord or any other electric device communication cables. Make sure also that neither cord nor cable is introduced to the machine inner mechanism. This would expose you to a machine malfunction risk or to a fire hazard.
- Make sure that the printer is unplugged from the power outlet before connecting or disconnecting an interface cable to the printer (use a shielded interface cable).
- Never try to remove any fixed pane or hood. The machine contains high voltage circuits. Any contact with these circuits can cause an electric shock risk.

- Never try to modify the machine. This could cause a fire hazard or an electric shock hazard.
- Always make sure that paper clips, staples or other small metallic items do not get inside the machine via the ventilation ports or other ports. Such items create fire hazards or electric shock hazards.
- Prevent water and any other liquid from spilling on the machine or near to it. Any contact of the machine with water or liquid can cause a fire hazard or an electric shock hazard.
- If liquid or metallic item gets accidentally inside the machine, turn it off immediately, unplug the power cord and contact your retailer. Otherwise, you will face a fire hazard or an electric shock hazard.
- In case of heat, smoke, unusual smell or abnormal noise emissions, turn the machine off, unplug the power cord immediately and contact your retailer. Otherwise, you will face a fire hazard or an electric shock hazard.
- Avoid using the machine during an "electric storm", this can cause an electric shock hazard due to lightning.
- Never move the terminal during printing.
- Always lift the terminal when you wish to move it.

Paper recommendations

Loading paper in the main unit tray

- Insert paper with the face down, and adjust paper guides to the paper format to avoid feed failure, skewing, and paper jams.
- Amount of loaded paper must not exceed the loading mark. If the loading mark is exceeded, this may cause feed failure, skewing, and paper jams.
- Adding paper in the pile must be avoided because it may cause double feeding.
- When withdrawing the cassette from the main unit, always support it with both hands to avoid doing drop it.
- If you use paper already printed by your machine or another printer, the printing quality may not be optimal.

Handling of paper

- Curling must be corrected before printing. Curls must not exceed 10 mm.
- Care must be taken with storage to prevent feed faults and image defects due to leaving the paper in conditions of high humidity.

Humidity control

- Paper which has become damp, or paper which has been left unused for a very long time.
- After opening the paper, it must be kept in a plastic bag.
- Paper with waved ends, paper which is creased, paper with crumples, and any other non-normal paper must not be used.

Use of envelopes

- Feeding can be done only through the manual feed.
- Recommended area should be the area which excludes 15 mm from the leading edge, 10 mm from and both the left and right edges, and the rear edge.
- A few lines may be given in solid print at the part of being overlapped.
- Envelopes which are not recommended may lead to improper printing (refer to the paragraph **Peripheral specifications**, page 63).
- Curled envelope after printing should be fixed manually.
- Small crumples on the edge of the wide side of envelopes. Smearing, or less clear printing may appear on the reverse side.
- Set envelope by pressing the folding line of four edges properly after releasing air inside. Set envelope in a proper position after aligning in case it is bent or warped.

EP Cartridge recommendations

- Must not be stood on the side, or held upside down.

Terminal description

Front side

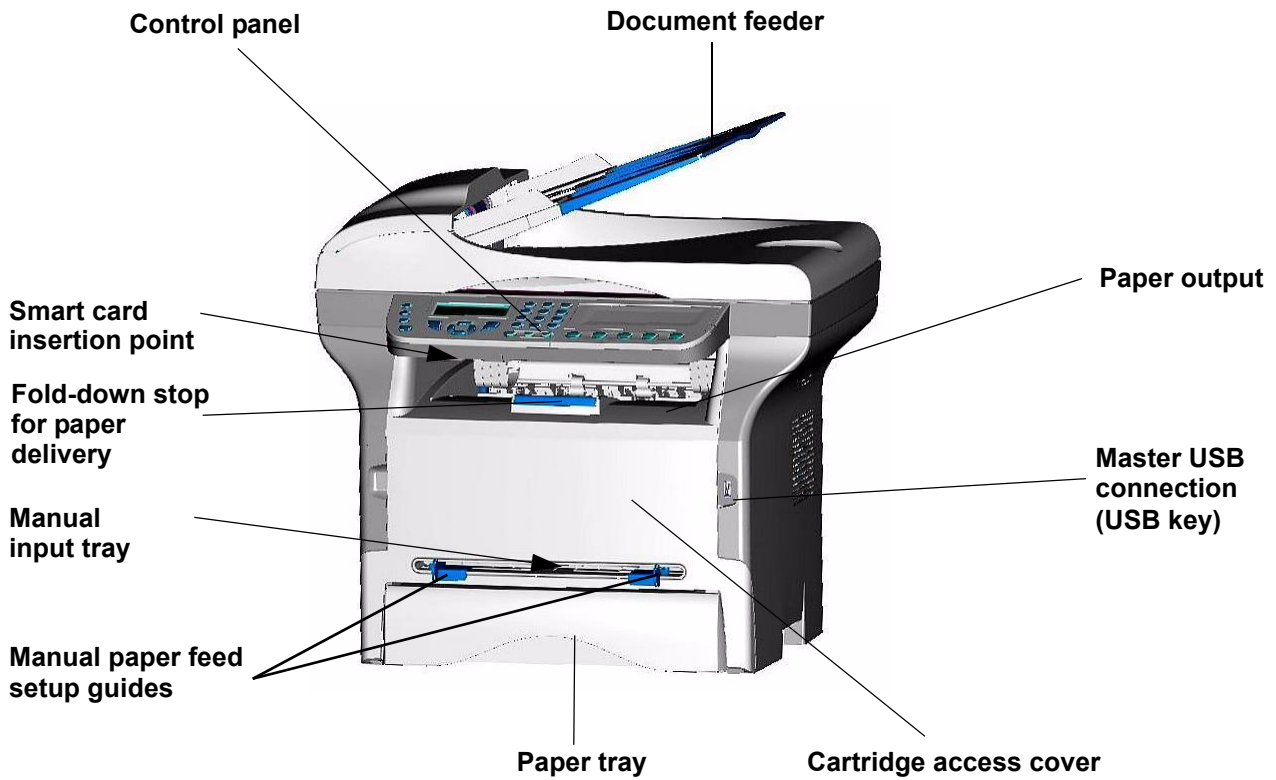

Back side

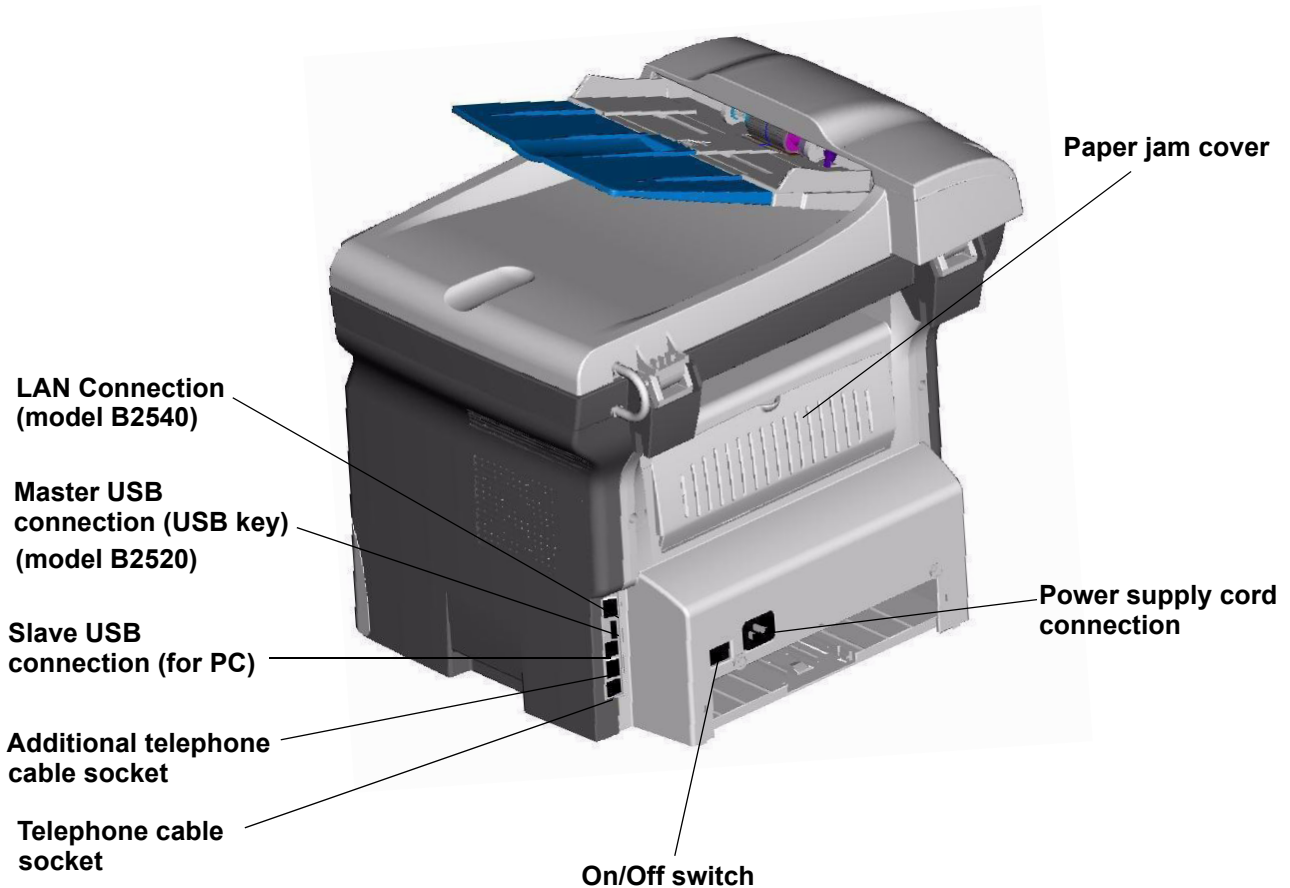

Command panel

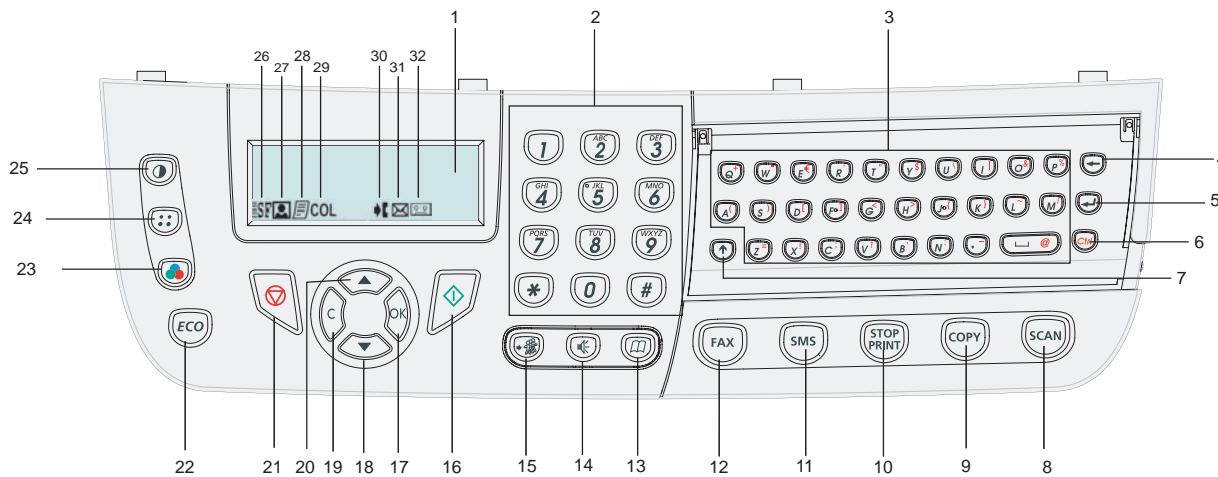

1. Screen.
2. Digital keypad.
3. Alphabetical keypad.
4. Key ←: deletes the character to the left of the cursor.
5. Key ↵: input or line feed.
6. Key CH: access to special characters.
7. Key ↑: Shift.
8. Key **SCAN**: document analysis to the PC.
9. Key **COPY**: local copy.
10. Key **STOP PRINT**: stops the current printing.
11. Key SMS: sending of an SMS (Short Message Service).
12. Key FAX: sending of a fax.
13. Key [book icon]: access to directory and quick dial numbers.
14. Key [phone icon]: line manual connection, listen for tone during fax sending.
15. Key [phone icon with dots]: multiple contact sending (fax, e-mail or SMS).
16. Key [checkmark icon]: Validation.
17. Key **OK**: confirms the displayed selection.
18. Key [down arrow icon]: menu access and navigation down the menus.
19. Key **C**: back to the previous menu and input correction.
20. Key [up arrow icon]: navigation up the menus.
21. Key [stop icon]: stops the current operation.
22. Key **ECO**: sets up the activation delay.
23. Key [color icon]: color analysis mode selection.
24. Key [dots icon]: analysis resolution setup.
25. Key [contrast icon]: contrast setup.
26. Icon [SF]: Superfin resolution.
27. Icon [photo icon]: Photo resolution.
28. Icon [F]: Fin resolution.
29. Icon **COL**: colour mode.
30. Icon [phone with lightning bolt icon]: activity on the telephone line.
31. Icon [envelope icon]: Fax mode.
32. Icon [phone with speech bubble icon]: external answering machine mode.

Accessing terminal menus

All terminal functions and settings are available via the menu and are associated to a specific menu command. For example, the menu command 51 launches the printing of the functions list (the functions list stores the list of all terminal menus, sub-menus and their identification number).

Two methods are available to access menu items : the step by step method or the shortcut method.

To print the functions list which details the Step by step method:

- 1 Press ▼.
- 2 Use the ▼ or ▲ button to browse the menu and select **5 - PRINT**. Confirm with **OK**.
- 3 Use the ▼ or ▲ button to browse the menu **PRINT** and select **51-FUNCTIONS LIST**. Confirm with **OK**.

To print the functions list with with the shortcut method:

- 1 Press on ▼.
- 2 Enter 51 with the numerical keypad to directly print the functions list.

Packaging contents

The packaging contains the items listed below:

Multifunction device



1 toner cartridge



1 installation guide, 1 PC installation CD ROM and 1 user guide CD ROM

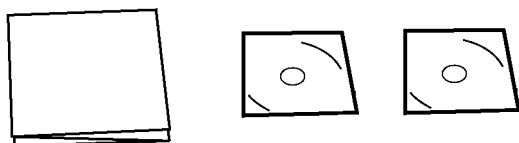

1 power cord



1 telephone cord



2 booklets (safety and warranty)

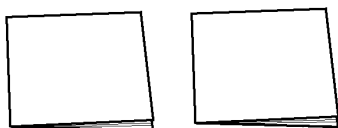

Device installation

- 1 Unpack the device.
- 2 Install the device respecting the security notices stated at the beginning of this booklet.
- 3 Remove all stickers from the machine.
- 4 Remove the plastic protection film from the screen.

Installing the document feeder

- 1 Secure the document feeder by fitting the two clips (B) in the notches (A) provided for this purpose.

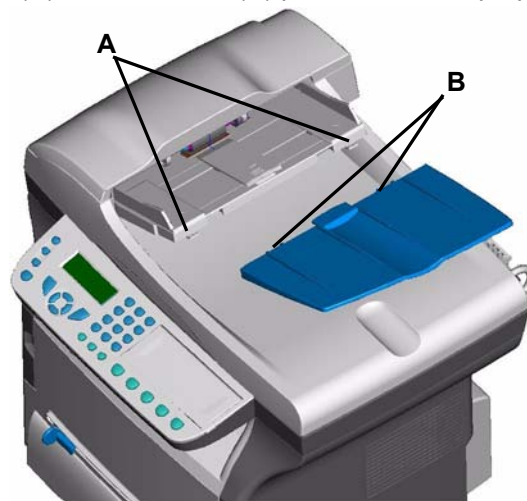

Feed cassette paper insertion



Before inserting paper, refer to the paragraph **Paper recommendations**, page 6.

Your device accepts a number of formats and types of papers (refer to the paragraph **Consumable specifications**, page 64).



You can use paper weighing between 60 and 105 g/m².

- 1 Remove the paper feed cassette completely.

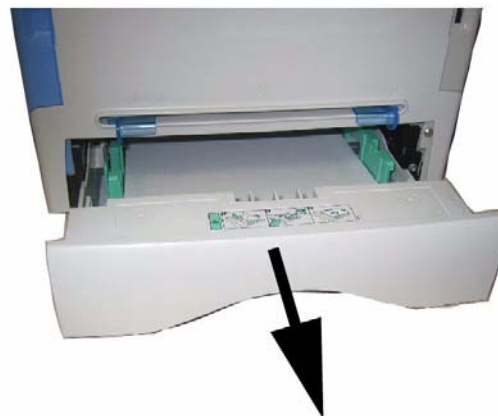

- 2 Push the lower panel down until it clicks.

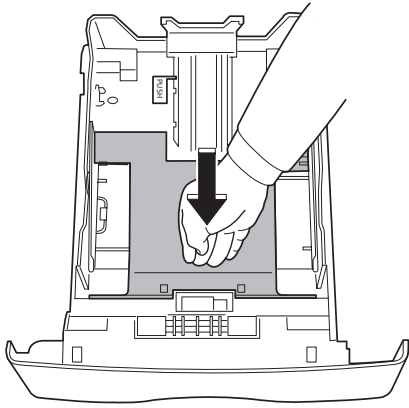

- 3 Setup the back side feed cassette stop by pushing the "PUSH" lever (A). Then adjust the lateral paper guides to the paper format by pushing lever (B) located on the left guide. Adjust the length paper guide to the paper format by pushing lever (C).

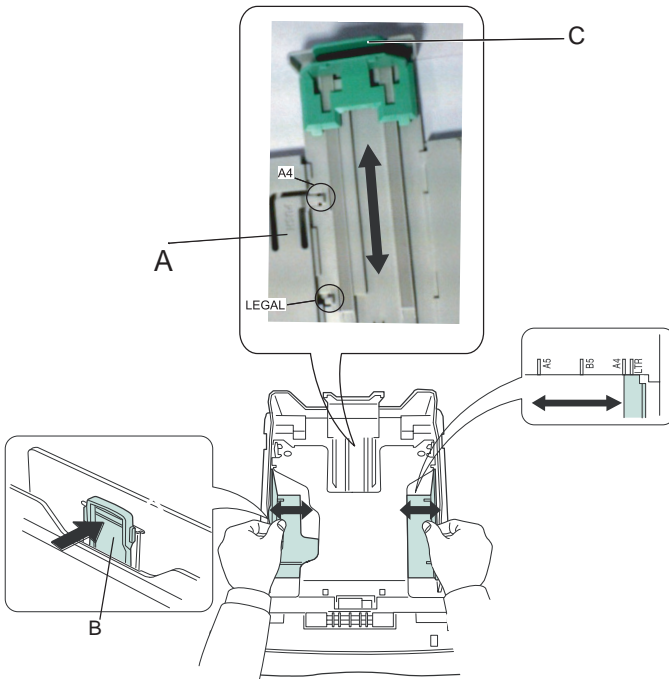

- 4 Take a paper stack, pull the paper off and align it on a flat surface.

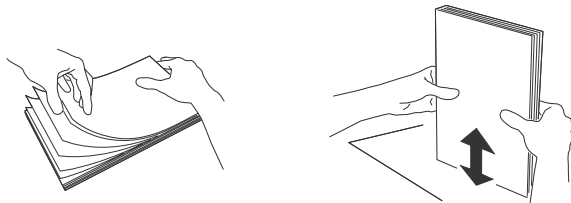

- 5 Put the paper stack in the feed cassette (ex: 200 sheets of 80 g/m² paper).
- 6 Put the feed cassette back in its location.

Cartridge installation

- 1 Stand in front of the machine.
- 2 Push the left and right sides of the cover and pull it towards you at the same time.



- 3 Unpack the new cartridge. Gently roll the cartridge 5 or 6 times to distribute the toner evenly inside the cartridge. Thoroughly rolling the cartridge will assure the maximum copies per cartridge.

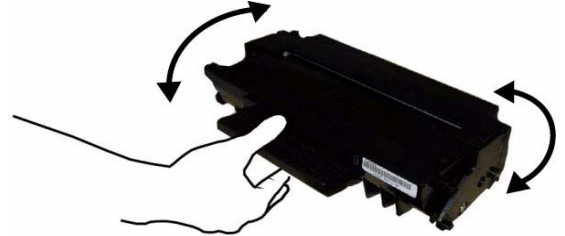

- 4 Insert the cartridge in its slot by pushing it until it clicks (last move down) as shown on the picture below.



- 5 Close the cover.

Paper delivery stop

Adjust the paper delivery stop, depending on the format of the document to be printed. Do not forget to raise the flap to prevent the sheets from falling down.



- For the model B2540, plug end of the LAN cord (as provided by your network administrator) into port of your fax machine and the other end into your local network port dedicated to your fax machine.

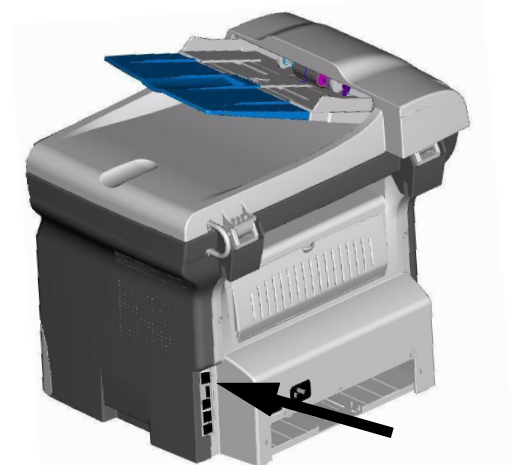

- Make sure that the On/Off switch is on Off (O position).
- Connect the power cord to the device. Plug the power cord to outlet on the wall

Starting your device

Device connection



*Before plugging the power cord, it is imperative to refer to the **Safety** booklet.*

- Plug the end of the telephone line into the terminal socket and the other end into the wall telephone socket.



- Press the On/Off button to turn on the device (I position).
- By default, the machine is set to operate in the UK in English. To modify this parameter, refer to **Country**, page 23.
- Set the date and time, refer to **Date/Time**, page 23.

Paper insertion in the manual input tray



Before inserting paper, refer to the paragraph **Paper recommendations**, page 6.

The manual input tray allows you to use various paper formats with greater weightings than the one used in the paper feed cassette (refer to the paragraph **Consumable specifications**, page 64).

Only one sheet or envelope can be fed at a time.



You can use paper, which weights between **52** and **160 g/m²**.

- 1 Spread the manual feed guides to the maximum.

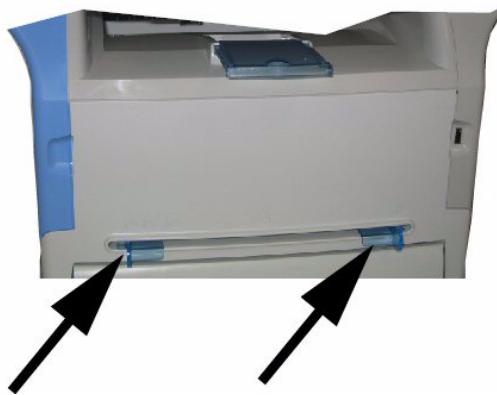

- 2 Insert a sheet or an envelope in the manual input tray.
 - 3 Adjust the paper guides against the right and left edges of the sheet or the envelope.
-



Before printing, check that the paper format you are using matches the paper format set on the printer (refer to **Copy**, page 13).

Copy

Your machine has the function to make one or more copies.

You can also setup several parameters in order to make copies at your will.

Simple copy



In this case, the default parameters are applied.

- Place the document to be copied in the automatic document feeder, printed face on the top.
or
Place the document to be copied face down on the glass, respecting the indications around the glass.
- Press the  button twice. The copy is made using the default parameters.

ECO mode copy

The ECO mode enables you to reduce the amount of toner consumed on the page so as to save your printing costs.

When the ECO mode is used, the toner consumption is reduced and the print density becomes lighter.

- Place the document to be copied in the automatic document feeder, printed face on the top.
or
Place the document to be copied face down on the glass, respecting the indications around the glass.
- Press the  button.
- Press the  button.

Advanced copying

The sophisticated copy allows to do custom setups for the current copy.

- Place the document to be copied in the automatic document feeder, face printed on the top.
or
Place the document to be copied face down on the glass, respecting the indications around the glass.



After step 1, you can directly enter the number of copies with the numerical keypad and press the **OK** button to validate. Then refer to step 4.

- Press the  button.
- Enter the number of copies that you want and confirm with the **OK** button.
- Choose the paper tray **AUTOMATIC** or **MANUAL** with the buttons \blacktriangle or \blacktriangledown , then confirm with the **OK** button.

- Choose with the buttons \blacktriangle or \blacktriangledown the printing option (see examples below) depending on the copy mode that you want:
- Combined mode (document feeder):
1 Page onto 1, **2 Pages onto 1**, or
4 Pages onto 1.

MOSAÏC Copy mode

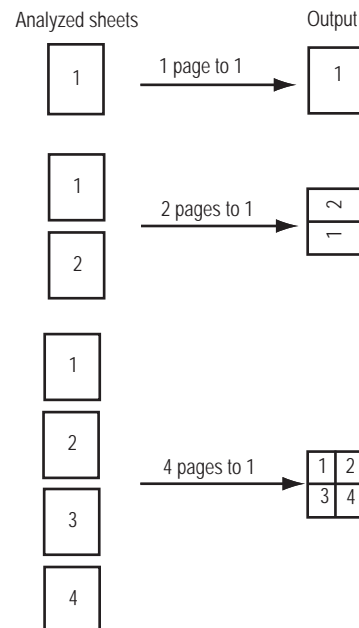

- Poster mode (flat-bed scanner): **1 Page to 1**, **1 Page to 4** or **1 page to 9**.

POSTER Copy mode

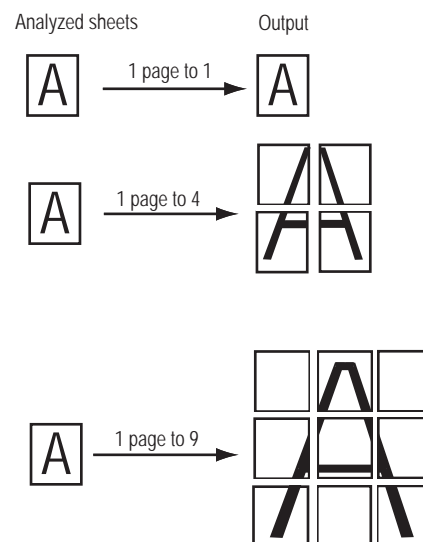

Confirm with the **OK** button.

- Adjust the desired zoom level, from **25% TO 400%** with the buttons \blacktriangle or \blacktriangledown , confirm with the **OK** button (only available in **1 Page to 1** copy mode).
- Adjust the desired origin values with the digital keyboard buttons \blacktriangle or \blacktriangledown then confirm with the **OK** button.
- Choose the resolution depending on the printing quality that you want **DRAFT**, **AUTO**, **QUALITY TEXT** or **PHOTO** with the buttons \blacktriangle or \blacktriangledown , then confirm with the **OK** button.

- 9 Adjust the contrast level with the buttons ▲ or ▼, then confirm with the **OK** button.
- 10 Adjust the desired brightness level with the buttons ▲ or ▼, then confirm with the **OK** button.
- 11 Choose the paper type **NORMAL**, **THICK** with the buttons ▲ or ▼, then confirm with the **OK** button.

Special setup for the copying

Setups done through this menu become the device **default setups** after you confirm.



When the quality of the printing is not satisfying, you can proceed to a calibration (see **Calibrate your scanner**, page 29).

Resolution setup

The **RESOLUTION** parameter allows you to setup the photocopy resolution.

▼ 841 - ADVANCED FCT/COPY/RESOLUTION

- 1 Choose the resolution with the buttons ▲ or ▼ according to the following table:

Parameter	Signification
DRAFT	Low resolution.
AUTO	Standard resolution for documents containing text and graphics.
QUALITY TEXT	Optimal resolution for documents containing text.
PHOTO	Optimal resolution for documents containing photographs.

- 2 Confirm your choice by pressing the **OK** button.



You can also change the resolution by pressing the  button.

Zoom setup

The **ZOOM** parameter allows you to reduce or enlarge an area of a document by choosing the origin and the zoom level to apply to the document, from 25 to 400 %.

▼ 842 - ADVANCED FCT/COPY/ZOOMING

- 1 Enter the desired zoom level with the Alphanumeric keyboard or choose among predefined values with the buttons ▲ and ▼.
- 2 Confirm your choice by pressing the **OK** button.

Assembled copy setup

▼ 843 - ADVANCED FCT/COPY/ASSEMBLED

The **ASSEMBLED** parameter allows you to assemble or disassemble your copies. Enter the desired setting and confirm your choice by pressing the **OK** button.

Analysis origin setup

If you want, you can change the origin of the scanner.

By entering new values for X and Y in mm (X < 209 and Y < 280), you move the analysed area as shown on the diagram below.

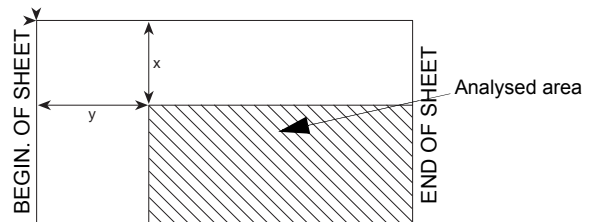



▼ 844 - ADVANCED FCT/COPY/ORIGIN

- 1 Select the X and Y coordinates with the buttons ▲ or ▼.
- 2 Setup the desired coordinates with the digital keyboard or the buttons ▲ and ▼, confirm your choice by pressing on the **OK** button.

Contrast setup

The **CONTRAST** parameter allows to choose the photocopy contrast.

▼ 845 - ADVANCED FCT/COPY/CONTRAST

- 1 Setup the desired level of contrast with the buttons ▲ and ▼, confirm by pressing the **OK** button.
- 2 You can also directly setup the desired contrast with the  button, press several times on this button until the desired setup without using the Menu 845.
- 3 Quit this menu by pressing the  button.

Brightness setup

The **BRIGHTNESS** parameter allows to lighten or darken your original document.

▼ 846 - ADVANCED FCT/COPY/LUMINOSITY

- 1 Setup the desired brightness with the buttons ▲ and ▼.
- 2 Confirm your choice by pressing the **OK** button.
- 3 Quit this menu by pressing the  button.

Paper type setup

▼ 851 - ADVANCED FCT/SCAN. & PRINT/PAPER TYPE

- 1 Select the paper **NORMAL** (60-90 g/m²) or **THICK** (90-162 g/m²) that you use with the buttons ▲ and ▼.
- 2 Confirm your setup by pressing the **OK** button.
- 3 Quit this menu by pressing the  button.

Paper tray selection

The **Automatic** selection can have two meanings depending on the paper format defined on the paper trays. The following table describes the different cases.

	Default tray	Tray used for copy
Same paper format in the trays	AUTOMATIC	Selection between the main tray and the manual tray.
	MANUAL	The manual tray is used.
Different paper format in the trays	AUTOMATIC	The main tray is used
	MANUAL	The manual tray is used.

▼ 852 - ADVANCED FCT/SCAN. & PRINT/TRAY PAPER

- 1 Select the default paper tray to use, **AUTOMATIC** or **MANUAL**, with the buttons ▲ and ▼.
- 2 Confirm by pressing the **OK** button.
- 3 Quit this menu by pressing the  button.

Sheet-feed analysis margins setup

If you want to, you can offset the lateral margins of the document to the left or right during the analysis with your sheet-feed scanner.

▼ 853 - ADVANCED FCT/SCAN. & PRINT/ S.F. MARGINS

- 1 Setup the left / right margins offsets (by 0.5 mm steps) with the buttons ▲ and ▼.
- 2 Confirm by pressing the **OK** button.
- 3 Quit this menu by pressing the  button.

Analysis margins setup

If you want to, you can offset the lateral margins of the document to the left or right during the analysis with your flat-bed scanner.

▼ 854 - ADVANCED FCT/SCAN. & PRINT/ FLATBED MARG

- 1 Setup the left / right margins offsets (by 0.5 mm steps) with the buttons ▲ and ▼.

- 2 Confirm by pressing the **OK** button.
- 3 Quit this menu by pressing the  button.

Left and right printing margins setup

If you want to, you can offset the lateral margins of the document to the left or right during printing.

▼ 855 - ADVANCED FCT/SCAN. & PRINT/ PRINTER MARG

- 1 Setup the left / right margins offsets (by 0.5 mm steps) with the buttons ▲ and ▼.
- 2 Confirm by pressing the **OK** button.
- 3 Quit this menu by pressing the  button.

Top and bottom printing margins setup

If you want to, you can offset the lateral margins of the document towards the top or the bottom during printing.

▼ 856 - ADVANCED FCT/SCAN. & PRINT/TOP PRINT.

- 1 Setup the top / bottom margins offsets (by 0.5 mm steps) with the buttons ▲ and ▼.
- 2 Confirm by pressing the **OK** button.
- 3 Quit this menu by pressing the  button.

Format paper setup

This menu allows you to define the default paper format of the manual tray and the main tray. You can also setup the default scanning width.

▼ 857 - ADVANCED FCT/SCAN. & PRINT/ PAPER FORMAT

- 1 Select the paper tray for which you want to define a default paper format with the buttons ▲ and ▼.
- 2 Confirm by pressing the **OK** button.
- 3 Choose the paper format with the buttons ▲ or ▼ according to the following table:.

Paper tray	Available paper format
MAN. TRAY	A5, A4, Legal and Letter
AUTO. TRAY	A5, A4, Legal and Letter
SCANNER	LTR/LGL and A4



- 4 Confirm by pressing the **OK** button.
- 5 Quit this menu by pressing the  button.

Fax

This chapter describes all the fax processing and configuration functions.
You will also find a section describing fax mailboxes.

Fax transmission

Immediate transmission

- 1 Place the document to be copied in the automatic document feeder, face printed on the top.
or
Place the document to be copied face down on the glass, respecting the indications around the glass.
 - 2 Enter the fax number or choose your dialling mode then press .
- The  icon flashes during the call phase, it stays lit when both faxes are in communication.
- 3 At the end of transmission the initial screen is displayed.

Delayed transmission

This function allows you to transmit a document at a later time.

To program a postponed transmission you need to identify the subscriber number, transmission time, feeder type and number of pages.



When sending in "Deferred Send" mode, make sure that the document is located in the right direction.

To delay the transmission time of your document :

- 1 Place the document to be copied in the automatic document feeder, face printed on the top.
or
Place the document to be copied face down on the glass, respecting the indications around the glass.
- 2 Select **▼ 31 - FAX / TRANSMISSION**.
- 3 Enter the subscriber number you wish to program at a different time or choose your dialling mode and confirm with **OK**.
- 4 Next to the current time, enter the new time and confirm with **OK**.
- 5 Choose **SCAN B & W** or **COLOR SCAN**.
- 6 Adjust the contrast and confirm with **OK**.
- 7 Select the feed type, **FEEDER** or **MEMORY** and confirm with **OK**.
- 8 You may enter the number of pages before transmission and confirm with **OK**.
- 9 Confirm postponed transmission by pressing

key .

Your document is stored and will be sent at the new time.



Transmission with auto redial

This function allows you to monitor the dialling operation during a fax transmission. In this case, the maximum transmission rate will be 14400 bps.

This function allows for example:

- to hear if the subscriber's fax is engaged and if so, choose the moment when the line is clear to start the document transmission.
- to control the communication progress in case of uncertain numbers, etc.

To take the line manually:

- 1 Place the document in the fax feeder.
- 2 Press .
- 3 If necessary, set the sound level with navigator **▲** or **▼** keys.
- 4 If not already done, enter the subscriber number. As soon as you hear the remote fax tone, the line is clear and you can start the transmission.
- 5 Press  to start the document transmission.



If your machine is set in order to print a transmission report (**Transmission report**, page 24), the reduced copy of the document first page will not be printed and it notifies you that the communication is manual.

Fax reception

Fax reception depends on the parameter settings of your machine.

The following parameters let you customize the printing of received faxes :

- **Reception Mode**, page 25;
- **Reception without paper**, page 25;
- **Number of copies**, page 25;
- **Fax or PC reception (depending on model)**, page 25;
- **Received faxes reduction mode**, page 25;
- **Technical Parameters**, page 26.



The printing is not possible on A5 paper format.

The following tables gives which tray is used to print received fax depending on the default tray and the paper format in both trays.

Default tray set to **Manual**:

Manual tray paper format	Main tray paper format	Action
A4,Letter and Legal	A4,Letter and Legal	The fax is printed on manual tray.
A4,Letter and Legal	A5	The fax is printed on manual tray.
A5	A4,Letter and Legal	An error message is displayed on the screen. The paper on manual tray is incompatible.
A5	A5	An error message is displayed on the screen. The paper on manual tray is incompatible.

Default tray set to **Automatic**:

Manual tray paper format	Main tray paper format	Action
A4,Letter and Legal	A4,Letter and Legal	The fax is printed with an automatic selection of tray.
A4,Letter and Legal	A5	An error message is displayed on the screen. The paper on automatic tray is incompatible.
A5	A4,Letter and Legal	The fax is printed on the main tray.
A5	A5	An error message is displayed on the screen. The paper on automatic tray is incompatible.

Relay broadcast

Your fax machine (initiator) can relay a document, in other words, transmit a document to your subscribers via a remote fax and with a precise relay list.

To do this the initiator fax and the remote fax must both have the relay function.

To relay you need to supply the remote fax with the document and the relay list number. The remote fax will then transmit this document to all subscribers on the list. Once the relay is activated by your fax and as soon as the document is received by the remote fax, the document is printed before relaying to all subscribers on the list.

To activate relay from your fax machine:

- 1 Insert the document to relay.
- 2 Select **▼37 - FAX / BROADCAST**.
- 3 Enter the remote fax number where you will relay to or choose your dialling mode and press **OK**.
- 4 Enter the relay list number used by the remote fax and press **OK**.

- 5 You may enter the time you wish to transmit the document next to the current time and press **OK**.
- 6 If you wish to modify the document feed type, select one of the options **FEEDER** or **MEMORY**, then press **OK**.
- 7 If you wish, you may enter the number of pages of your documents before transmitting.
- 8 Activate relay by pressing key .

The document in the feeder will be relayed either immediately or at a later time (according to your choice) to the remote fax which will relay the document.

Fax answering machine

The Fax answering machine allows you to keep confidential documents in storage and to avoid printing them as you receive them.

The  indicator light lets you know the state of your Fax answering machine:

- Light on: the answering machine is on.
- Blinking: your fax has documents in storage or is in the process of receiving faxes.
- Light off: memory full, the terminal cannot receive any more documents.

You can assure document confidentiality by using the 4 digit access code. Once saved, you will require this access code for:

- printing fax messages in memory,
- activating or deactivating the fax answering machine.

Saving an access code

▼383 - FAX / FAX ANSW. / ANSWER CODE

- 1 Enter the code (4 digits) and confirm with **OK**.
- 2 Quit this menu by pressing the  button.

Activating / Deactivating the answering machine

▼382 - FAX / FAX ANSW. / ACTIVATION

- 1 If you saved an access code for your fax answering machine, enter it and validate with **OK**.
- 2 Select the required option **WITH** or **WITHOUT** answering machine and confirm your choice with **OK**.
- 3 Quit this menu by pressing the  button.

Printing fax messages stored in the memory



The printing is not possible on A5 paper format.

▼381 - FAX / FAX ANSW. / PRINT

- 1 If you have defined an access code for your fax answering machine, enter it and press **OK**.

Documents received and stored in the memory are printed.

Fax rerouting

This function is used to reroute faxes received to a directory contact. To use this function, you have to perform two operations:

- 1 Activate rerouting.
- 2 Set the rerouting address of the fax.

Activating rerouting

▼391 - FAX / REROUTING / ACTIVATION

- 1 Using the keys ▼ and ▲ within the navigator, select option **WITH** and confirm with **OK**.
- 2 Quit this menu by pressing the  button.



*If the function **WITHOUT** is selected, the menus 392 and 393 will not be included in the functions overview, when it is printed out (see **Setting the re-direction contact**, page 18, **Printing rerouted documents**, page 18 and **Printing the functions guide**, page 27.*

Setting the re-direction contact



*Make sure that the subscriber exists in the directory (**Directory**, page 30).*

▼392 - FAX / REROUTING / DESTINATION

- 1 Using the keys ▼ and ▲ within the navigator, select the subscriber from the directory.
- 2 Quit this menu by pressing the  button.

Printing rerouted documents

▼393 - FAX / REROUTING / COPY

- 1 Using the keys ▼ and ▲ within the navigator, select the **COPY** option (local printout of the information relayed to your device) either **WITH** or **WITHOUT**.
- 2 Confirm with **OK**.
- 3 Quit this menu by pressing the  button.

Rerouting fax messages to a USB memory key

This function allows you to reroute received fax messages to a USB memory key connected to your terminal. The USB memory key then becomes the terminal reception memory.

Fax messages that are rerouted are therefore saved on the USB memory key with format Tiff and are named as follows : "FAXYYMMDDHHMMSS" where YYMMDDHHMMSS corresponds to the fax reception date and time.

You can also print fax messages rerouted to your USB memory key automatically by activating menu **052 PRINT**.

Activating rerouting



Before activating this function, connect the USB memory key to the terminal.

▼051 - MEDIA / FAX ARCHIVING / ACTIVATION

- 1 Using the keys ▼ and ▲ within the navigator, select option **WITH** and confirm your choice with **OK**.
- 2 Quit this menu by pressing the  button.

Printing rerouted documents



The printing is not possible on A5 paper format.

▼052 - MEDIA / FAX ARCHIVING / IMPRIMER

- 1 Using the keys ▼ and ▲, select the copy option **WITH** to print all rerouted documents automatically.
- 2 Confirm your choice with **OK**.
- 3 Quit this menu by pressing the  button.

Transmission waiting queue

This function lets you obtain a recap of all documents queuing, for transmission, including those in deposit or in delayed transmission, etc.

It allows you to:

- **Consult** or **modify** the waiting queue. In this waiting queue the documents are coded the following way:
Order number in the queue / document status / subscriber's telephone number.
Documents may have the following status:
 - **TX**: transmission
 - **REL**: relay
 - **DOC**: in deposit
 - **POL**: polling
 - **MBX**: send to mailbox
 - **PMB**: mailbox polling
 - **TR**: ongoing commands
 - **SMS**: SMS transmission
- **Immediately perform** a transmission from the waiting queue,
- **Print a document** in storage, waiting to be transmitted or in deposit,
- **Print the waiting queue**, in order to get the status of each document in the queue, by either:
 - queue order number,
 - document name or number,
 - scheduled transmission time (fax),
 - operation type regarding the document: transmission from memory, delayed transmission, deposit,
 - number of pages of the document,
 - document size (percentage of space stored in memory)
- **Cancel** a transmission request in the waiting queue.

Performing immediate transmission from the waiting queue

▼ 61 - COMMANDS / PERFORM

- 1 Select the document in the waiting queue and confirm your choice with **OK** or  to immediately perform the selected transmission.

Consulting or modifying the waiting queue

▼ ▼ 62 - COMMANDS / MODIFY

- 1 In the waiting queue select the required document and confirm your choice with **OK**.
- 2 You may now modify the parameters of the given document then confirm your modifications by pressing .

Deleting a transmission on hold

▼ 63 - COMMANDS / CANCEL

- 1 In the waiting queue select the desired document and confirm your choice with **OK**.

Printing a document in waiting or in deposit

▼ 64 - COMMANDS / PRINT

- 1 In the waiting queue select the desired document and confirm your choice with **OK**.

Printing the waiting queue

▼ 65 - COMMANDS / PRINT LIST



A document called ** COMMAND LIST ** is printed.

Cancelling a transmission in progress

Cancelling a transmission in progress is possible no matter what the type of transmission but varies depending on whether the transmission is a single call number or a multi-call number.

- For a single call number from the memory, the document is erased from the memory.
- For a multi-call number, only the call number in progress at the time of the cancellation is erased from the transmission queue.

To cancel transmission in progress:

- 1 Press .
A message will ask you to confirm cancellation by pressing  a second time.
- 2 Press  to confirm cancellation in progress.

If your machine is set to print a transmission report, it will print that the communication was cancelled by the user.

MailBoxes (MBX Fax)

There are 32 mailboxes (MBX), enabling you to transmit documents in complete confidence using an access code (named MBX code), to all subscribers equipped with a fax compatible to yours.

MBX 00 is public. It is handled directly by the terminal to record the messages of the fax TAD as soon as this is put into service.

MBX's 01 to 31 are private. Each is password-protected. They can be used to receive documents confidentially.

The use and access to MBX 01 - 31 are conditioned by the initialisation, defined by a MBX code (if needed) and a mnemonic (its S.I.D.).

Later you may:

- modify the features of an MBX,
- print the contents of an MBX, only possible if the MBX contains one or more documents (with a star next to the MBX). When the contents of an MBX have been printed it becomes empty,
- delete an MBX, only if the MBX is initialised and empty,
- print the the list of your fax machine's MBX's.

You may receive and send through an MBX in complete confidentiality.

When depositing a document into your MBX, the access code is not needed. All documents deposited in a MBX are added to the ones already present.

In polling, the MBX's are only accessible with an MBX code.

You may perform MBX deposits or polls by:

- depositing a document in a fax MBX,
- transmitting to deposit a document in a remote fax MBX,
- performing document poll from a remote fax.

Creating an MBX

▼ 71 - MAILBOXES / CREATE MBX

- 1 Select a free MBX out of the 31 MBX or directly enter the number of a free MBX and confirm with **OK**.
- 2 Select option **MAILBOX CODE** and press **OK**. Value 0000 is always displayed.
- 3 Enter the code of your choice, if needed, and press **OK**.
- 4 Select option **MAILBOX NAME** and press **OK**.
- 5 Enter this MBX's S.I.D. (20 characters max.) and press **OK**.
The MBX is initialised. If you wish to initialise another, press **C** and repeat the same procedure.

- 6 To exit the MBX, press .

Modifying the features of a MBX

▼ 71 - MAILBOXES / CREATE MBX

- 1 Select the desired MBX out of the 31 MBX's, or enter the number of the MBX directly and press **OK**.
- 2 Enter the code of this MBX, if there is one, and confirm with **OK**.
- 3 Select the menu **MAILBOX CODE** or **MAILBOX NAME**, then confirm your choice with **OK**.
- 4 Perform data modification of the menu and confirm with **OK**.

If needed, repeat the last two steps for the other menu.

Printing the contents of a MBX

▼ 73 - MAILBOXES / PRINT MBX

- 1 Select the desired MBX out of the 31 MBX's, or enter the number of the MBX directly and press **OK**.
- 2 Enter the code of this MBX, if there is one, and confirm with **OK**.

All documents found in the MBX are printed and the MBX is emptied.

Deleting a MBX

Before deleting an MBX, you need to make sure it is empty, by printing its content.

▼ 74 - MAILBOXES / DELETE MBX

- 1 Select the desired MBX out of the 31 MBX's, or enter the number of the MBX directly and press **OK**.
- 2 Enter the code of this MBX, if there is one, and confirm with **OK**.
- 3 Press **OK** to confirm the MBX deletion.

The MBX is deleted and will appear as a free MBX in the list.

Printing the MBX list

▼ 75 - MAILBOXES / PRT MBX LIST

The list gives the status of each MBX.

MBX deposit in your fax

- 1 Insert the document in the fax machine's feeder.
- 2 Select ▼ **72 - MAILBOXES / DEPOSIT MBX** and confirm with **OK**.
- 3 Select the desired MBX out of the 31 MBX's, or enter the number of the MBX directly and press **OK**.

The document is placed in the feeder and saved in the selected MBX.

MBX deposit in a remote fax

- 1 Insert the document in the fax machine's feeder.
- 2 Select ▼ **35 - FAX / MBX SENDING** and confirm with **OK**.
- 3 Enter your subscriber's number for MBX deposit or choose your dialling mode and validate with **OK**.
- 4 Enter the subscriber's MBX number and confirm with **OK**.
- 5 If you wish to delay transmission, enter the new transmission time next to the current time and press **OK**.
- 6 If you wish to modify the document feed type, select one of the options **FEEDER** or **MEMORY**, and press **OK**.
- 7 If you wish, you may enter the number of pages of your document before transmitting and confirm with **OK**.
- 8 Confirm the transmission request to a remote MBX

fax by pressing key .

In the case of an immediate transmission, the document is sent immediately.

If the document is set for a postponed transmission, the document will be stored in the memory and sent at the requested time.

MBX polling from a remote fax

▼36 - FAX / MBX POLLING

- 1 Enter your subscriber's number for MBX polling or choose your dialling mode and confirm with **OK**.
- 2 Enter the subscriber MBX number and press **OK**.
- 3 Enter this MBX access code and press **OK**.
- 4 If you wish to delay the poll time, enter the departure time next to the current time and press **OK**.
- 5 Confirm the MBX poll request by pressing .

As soon as the remote fax is subscribed, either immediately or later, the document(s) in the remote fax MBX are received in your fax.



Please check for remote fax compatibility.

Deposit and Polling

You may **deposit** a document in your fax and keep it available to one or more subscribers who can obtain a fax of this document by calling your fax with the **POLL** function.

Setting the machine for document deposits, you must define the type:

- **SIMPLE**- it may be polled only once from the memory or feeder,
- **MULTIPLE**- it may be polled as many times as necessary from the memory.

Setting the machine for polled documents, you must define the poll number, then depending on the type of poll you may:

- launch an immediate poll,
- program a delayed poll with a chosen time,
- launch a multi-poll, either immediately or later.

Placing a document in deposit

- 1 Insert the document to deposit in the feeder.
- 2 Select ▼34 - FAX / POLLING TX and confirm with **OK**.
- 3 Choose the deposit type, according to the table below:

Menu	Procedure
Simple	1 Select FEEDER or MEMORY .
	2 If necessary, adjust the contrast and confirm with OK .
	3 Enter the number of pages that you wish to deposit.
Multiple	1 If necessary, adjust the contrast and confirm with OK .
	2 Enter the number of pages that you wish to deposit.

- 3 Confirm deposit by pressing **OK**.



Polling a deposited document

▼33 - FAX / POLLING RX

- 1 Enter the number of the party whose document you want to poll or choose your dialling mode.

You can poll several documents using the key .

- 2 Depending on the type of poll, you should:

Choice	Procedure
Immediate poll	1 Press  .
Delayed poll	1 Press OK .
	2 Next to the current time, enter the time you wish to poll the document and press  .

SMS

Thanks to the **SMS** button, you can send an SMS to subscribers all over the world. An SMS (Short Message Service) is a service which permits short written messages to be sent to mobile phones or other SMS-compatible devices.

The number of characters you can send per message is dependent upon the service provider and the country you are sending your SMS from (e.g. France 160 characters, Italy 640 characters).

The SMS service is dependent upon the country and the service provider.



There is a special scale of charges for the SMS service.

SMS Parameters

Presentation of the sender

This setting allows you to show the name or the number of the sender when sending an SMS.

▼ 41 - SMS SERVICE / SENDER

- 1 Select the option **WITH** or **WITHOUT** presentation of the sender using the ▲ or ▼ keys.
- 2 Validate with **OK**.



SMS Center transmission number

This setting allows you to enter the transmission number for the SMS Server. Your Internet provider will provide you with this number.

▼ 421 - SMS SERVICE / INIT. SMS / SERVER

- 1 Enter the number of the transmission server using the digital keypad.
- 2 Validate with **OK**.

Sending an SMS

- 1 Press the  key.
 - 2 Write your SMS using the alphabetical keypad. To do so, an editor is at your disposal:
 - for upper case letters, use the ↑ key,
 - to move inside the data entry field, use ▼ and ▲,
 - to move in the text from one word to another, press **CTRL** and one of the navigator keys (▼ or ▲).
 - to go to the next line, use ↵,
 - to delete a character (by moving the cursor to the left), use ← or **C**.
 - 3 Validate with **OK**.
 - 4 Dial the number of the recipient (mobile phone or any other SMS-compatible device) in one of the following ways:
 - dial the number using the digital keypad,
 - enter the first letters of the recipient name,
 - press the  key until the required name appears (names are classified in alphabetical order).
Your SMS may be sent to only one person or to several people. To send an SMS:
 - to only one person, press **OK** to confirm,
 - to several people:
 - 5 Press the  key and enter the next recipient's number.
 - 6 Repeat the operations as many times as required (10 persons max.). Press **OK** to validate the last recipient; "**SENDING SMS**" is displayed as the SMS is being sent.
- If **SMS** appears, then the SMS has been put on hold and a further attempt will take place a couple of minutes later. To immediately execute or cancel transmission, refer to paragraph **Transmission waiting queue**, page 19.
 - To check the SMS has been sent properly, you may print the transmission/reception log (refer to paragraph **Printing the logs**, page 28).

Parameters/ Setup

You can setup your machine as you like depending on the use. You will find in this chapter description of the functions.

You can print the functions guide and the available setup of your multifunction machine.



Your machine is continuously being updated, new functions are regularly made available. To benefit, visit our website and download the last updates.

Date/Time

At any moment you may change the date and time on your multifunction machine.

▼ 21 - SETUP / DATE/TIME

- 1 Press **▼**, enter **21** using the keypad. Confirm with **OK**.
- 2 Enter the numbers of the required time and date one after another (for example November 8 2004 at 9h33, press 0 8 1 1 0 4 0 9 3 3) and press **OK** to confirm.
- 3 To exit this menu, press .

Your fax number/Your name

Your multifunction machine will print out your fax number and your name on each document it transmits if you save these settings.



To benefit from this feature, you must set **SENDING HEADER** to **WITH** (Technical Parameters, page 26).

▼ 22 - SETUP / NUMBER/NAME

- 1 Press **▼**, enter **22** using the keypad. Confirm with **OK**.
- 2 Enter your fax number (20 digits max.) and press **OK** to confirm.
- 3 Enter your name (20 characters max) then press **OK** to confirm.

For example, if you want to type the letter C, press the key **C** until it appears on the screen.

- 4 To exit this menu, press .

Type of network

You can connect your fax to either a PSTN or a private network such as private automatic branch exchange (PABX). You must select the network which is in use.

To select the type of network:

▼ 251 - SETUP / TEL. NETWORK / NETWORK TYPE

- 1 Select option **PABX** or **PSTN** then confirm your choice with **OK**.
- 2 To exit this menu, press .

Geographical settings

These settings will enable you to use your machine in different preset countries using different languages.

Country

By choosing a country, you initialise:

- the settings for the public telephone network,
- the language by default.

To select the country:

▼ 201 - SETUP / GEOGRAPHICAL / COUNTRY

- 1 Select the required option and press the **OK** key to confirm.
- 2 To exit this menu, press .

Network

This setting enables you to manually set the type of public telephone network (PSTN) for a country, so that your machine can communicate over the public telephone network in compliance with the applicable standards.

By default, setting a country using the **▼201 OK** command automatically sets the type of PSTN to use in the selected country.



These settings are different from the **NETWORK TYPE**, which allows you to choose between public and private network.

To manually select the type of public telephone network:

▼ 202 - SETUP / GEOGRAPHICAL / NETWORK

- 1 Select the required option and press the **OK** key to confirm.
- 2 To exit this menu, press .

Language

This setting enables you to choose the menu language of your choice. By default, the multifunction machine is set to English.

▼203 - SETUP / GEOGRAPHICAL / LANGUAGE

- 1 Select the required language using ▼ and ▲, then press the **OK** key to confirm.
- 2 To exit this menu, press .

Local prefix

This function is used when your fax is installed with a private network, behind a company's PABX. It allows you to program an additional automatic **local prefix** (to be defined), enabling you to automatically exit the company's telephone network system, but only under certain conditions:

- the company's internal numbers, where a prefix is not required, must be short numbers less than the **minimal size** (to be defined, for example France has 10 digits),
- the outside numbers requiring a prefix, must be long numbers greater or equal to the **minimal size** (to be defined, for example France has 10 digits).

Programming your fax with the local prefix consists of two steps:

- 1 defining the **minimal size** (or equal) of the company's outside numbers,
- 2 defining the outgoing **local prefix** of the company's telephone network. This prefix will automatically be added as soon as an external number is dialled.



If you define a local prefix, do not add it to the numbers stored in the directory, it will be automatically dialled with each number.

Prefix

▼252 - SETUP / TEL. NETWORK / PREFIX

- 1 You can change the default value for the minimal size of the company's outside numbers and validate with **OK**.
The minimal size will range between 1 and 30.
- 2 Enter the outgoing local prefix of the company's telephone network (maximum 5 characters) and validate with **OK**.
- 3 To exit this menu, press .

Transmission report

You may print a **transmission report** for all communications over the telephone network (PSTN). You may choose between more than one criteria for printing reports:

- **WITH**: a report is given when the transmission was properly performed or when it is completely abandoned (but there is only one report per request),
- **WITHOUT**: no transmission report, however, your fax will note all transmissions that took place in its log,
- **ALWAYS**: a report is printed with each transmission,
- **ON ERROR**: a report is printed only if the transmission failed or is abandoned.

With each transmission report from memory, a reduced version of the first page is automatically reproduced.

To select the report type:

▼231 OK - SETUP / SEND / SEND REPORT

- 1 Select the required option **WITH**, **WITHOUT**, **ALWAYS** or **ON ERROR** and confirm your choice with **OK**.
- 2 To exit this menu, press .

Document feed type

You may choose the way you want to feed your documents:

- from **memory**, transmission will take place only after memory storage of the document and dialling. It allows you to get your originals back quickly to free up the machine.
- from the **feeder** of the sheet-feed scanner, transmission will occur after dialling and paper scanning. It allows transmission of larger documents.

To select the way you want to feed your documents:

▼232 - SETUP / SEND / MEMORY SEND.

- 1 Select the option **MEMORY** or **FEEDER** and validate your choice with **OK**.
In feeder mode, reduced images will not appear on the transmission report.
- 2 To exit this menu, press .

Economy period

This function allows you to defer a fax transmission to "off-peak hours" and thus reduce the cost of your communications.

The **economy period**, via the telephone network (at off-peak hours), is preset by default from 7.00 pm to 7.30 am. Nevertheless you may change this time slot.

To modify the economy period:

▼233 - SETUP / SEND / ECO PER.

- 1 Enter the hours of the new economy period and confirm your selection with the key **OK**.

To use the economy period:

▼32 - FAX / ECO TRANS.

- 1 Enter the call number and confirm with **OK**.
- 2 Choose **SCAN B & W** or **COLOR SCAN**.
- 3 Adjust the contrast and confirm with **OK**.
- 4 Select the feed type, **FEEDER** or **MEMORY** and confirm with **OK**.
- 5 You may enter the number of pages before transmission and confirm with **OK**.

Reception Mode

This function allows you, when you connected an external device (telephone, answering machine) to your terminal, to select the device you wish to receive fax and / or voice messages on.

You may choose between the following reception modes :

- **MANUAL** : the terminal does not receive any documents automatically. When you receive a fax message, you must press the  button to receive the fax message on your terminal.
- **FAX** : the Fax reception mode is launched on the terminal systematically.
- **FAX-ANSWER.** : the terminal handles reception of fax messages automatically, the external device handles reception of telephone communications automatically.

To set the reception mode:

▼241 - SETUP / RECEPTION / MODE

- 1 Select the required option and confirm with **OK**.
- 2 To exit this menu, press .

Reception without paper

Your fax offers you the possibility to either accept or refuse document reception if your printer is unavailable (no paper...).

If your fax printer is unavailable, you may choose between two modes of reception:

- reception mode **WITHOUT PAPER**, your fax saves the incoming messages in the memory,
- reception mode **WITH PAPER**, your fax refuses all incoming subscribers.

To select the reception mode:

▼242 OK - SETUP / RECEPTION / REC. PAPER

- 1 Select the option **WITH PAPER** or **WITHOUT PAPER** and confirm your choice with **OK**.



*Paper out is indicated by a beep and a message on the screen.
Received faxes are then stored in memory (icon  flashing) to be printed as soon as you add paper into the feeder.*

Number of copies

You may print incoming documents more than once (1 to 99).

To set the number of each document received:

▼243 - SETUP / RECEPTION / NBR OF COPIES

- 1 Enter the wanted number of copies and confirm with **OK**.

At each document reception, your fax will print the number of copies requested.

Fax or PC reception (depending on model)

This menu, combined with a software program installed on your PC will enable you to select the machine you wish to receive the documents on:

- fax,
- PC,
- PC if available, fax otherwise.

▼244 - SETUP / RECEPTION / PC RECEPT.

For more details, please refer to section **PC Features**, page 42.

Received faxes reduction mode

This menu allows you to reduce received faxes for printing. This adjustment can be automatic or manual.

Automatic mode:

This mode automatically resizes received faxes.

To set automatic mode:

▼246 - SETUP / RECEPTION / REDUCTION

- 1 Select **Automatic** and confirm with **OK**.
- 2 To exit this menu, press .

Manual mode:

The machine proposes a 70 to 100 % reduction. Outside these values, the machine beeps for error. This fixed reduction will be used when printing received documents, regardless of the used paper format.

To set the manual mode:

▼246 - SETUP / RECEPTION / REDUCTION

- 1 Select **FIXED** and confirm with **OK**.
- 2 Enter the reduction value (between 70 and 100) and confirm with **OK**.
- 3 To exit this menu, press .

Technical Parameters

As delivered your machine is preset by default. However, you may adjust it to meet your requirements by resetting the technical parameters.

To set the technical parameters:

▼ 29 - SETUP / TECHNICALS

- 1 Select the desired parameter and confirm with **OK**.
- 2 With the keys ▼ or ▲, modify the parameter settings by following the table below and press **OK**.

Parameter	Signification
1 - Scanning mode	Default value of the scan mode resolution for the documents to be transmitted.
2 - TX header	If this parameter is on, your header will appear on all documents sent to your subscribers with your name, number, date and number of pages. Warning: If you send a fax from the document loader, the transmission header will not appear on the document your correspondent receives.
3 - TX speed	Transmission speed for outgoing documents. For a quality telephone line (compatible, no echo), communications occur at maximum speed. However, it may be necessary to restrict the transmission speed for some calls.
4 - Echo protect	If this parameter is on, the on-line echo will be reduced during long distance calls.
6 - EPT mode	For some long distance calls (satellite), the on-line echo may disturb the call.
7 - COM. display	Choice between transmission speed displayed or number of the page in progress.
8 - Eco energy (ECO)	Choosing the printer standby delay: the printer will switch to standby after a delay (in minutes) of NON-operation or during the period of time of your choice.

Parameter	Signification
10 - RX header	If this parameter is on, all documents received by your fax will include the subscriber's header with his name, number (if available) fax print date and the page number.
11 - RX speed	Transmission speed for incoming documents. For a quality telephone line (compatible, no echo), communications occur at maximum speed. However, it may be necessary to restrict the transmission speed for some calls.
12 - Rings	Number of rings to automatically start your machine.
13 - Discard size	The Discard Size parameter only defines the printing of received faxes . The number of lines of a document can be too high for the printing paper format. This parameter defines the threshold beyond which the extra lines are printed on a second page. Below this threshold, extras lines are deleted. If you choose With , the threshold is set on 3 centimeters. If you choose Without , the threshold is set on 1 centimeter.
20 - E.C.M.	This parameter helps correct the calls made on disturbed telephone lines. It is used when the lines are weak or too noisy. Transmission times may be longer.
25 - TEL Impedance	This parameter lets you choose between a complex impedance and a 600 Ohm impedance, depending on the telephone network your terminal is connected to.
73 - Improve rep @	This parameter lets you automatically register the Internet address of your subscribers fax during a call (if available).

Parameter	Signification
74 - Erase mailbox	When the fax machine receives an e-mail with an attachment and cannot open it, it erases the message from the ISP MBX, prints and transmits with a notice of uncomprehension to the message sender. At E-mail reception, the fax does not destroy the MBX message, it prints a notice of uncomprehension asking you to recuperate this message with your computer equipment. This parameter is useful only if you have PC equipment. The memory capacity is limited, you need to empty your MBX or else new messages may not be received.
75 - Text Attchmt.	Editing YES / NO and printing the received Internet documents.
76 - Attchmt format	Default format of document sent on the Internet: PDF : monochrome or colour IMAGE : monochrome (TIFF) or colour (JPEG)
77 - LAN speed	To define the communication speed of the peripheral units in relation to the implemented Local Area Network (LAN).
80 - Toner save	Makes printing lighter to save toner cartridge ink.
81 Font number	Starts the printing of the log list. This parameter lets you set the default PCL font. The possible values are included between 5 and 128 inclus. The default value is 0 (Courier).
82 Form lines	This parameter lets you set the number of lines per page. This variable is linked to the PCL variables: PAPER and ORIENTATION. If you modify one of these variables, the Form Lines variable is automatically updated (only for the print job in progress) to respect the same spacing. The possible values are included between 5 and 128 inclus. The default value is 60.
83 Font pitch	This parameter lets you set the default font spacing, in characters per inch (the default font must be of type non-proportional). The possible values are included between 0,44 and 99,99 inclus. The default value is 10,00.

Parameter	Signification
84 Ptsize	This parameter lets you set the default font height, in points (the default font must be of type proportional). The possible values are included between 4,00 and 999,75 (by step of 0,25). The default value is 12,00.
85 Line termin.	This parameter lets you define line breaks conversion: <CR>, <LF> and <FF>. The possible values are included between 0 and 3. The default value is 0.
86 Orientation	This parameter lets you set the page orientation: portrait or landscape. The default value is "portrait".
90 - RAW Port	RAW network print port connection.
91 - Printer error timeout	Time-out before document being printed is deleted following a print error in PC print mode.
92 - Printer wait timeout	Wait time-out for data from PC before the task is deleted in PC print.
93 - Replace format	Page format change. This parameter allows you to print a LETTER format document on A4 pages using the LETTER/A4 setting.
94 - Printer class	Printing in PCL-/Postscript Mode Printing in GDI mode
95 Symbol set	This parameter lets you set the default character set. The possible values are included between CS1 and CS30 inclus. The default value is CS1 (Roman8).
96 - NBR. WEP Keys	Number of WEP keys allowed (from 1 to 4).

Printing the functions guide



The printing is not possible on A5 paper format.

▼ 51 - PRINT / FUNCTIONS LIST

- 1 Press on ▼ and enter **51** with the digital keypad.

The printing of the functions guide starts.

Printing the logs



The printing is not possible on A5 paper format.

The incoming and outgoing logs list the last 30 transmissions (incoming and outgoing) made by your machine.

An automatic print out will take place after every 30 transmissions. However, you may request a print out at any time.

Each log (incoming or outgoing) contains a table with the following information:

- date and time of the incoming or outgoing document,
- subscriber's number or E-mail address,
- transmission mode (**Normal**, **Fine**, **SFine** or **Photo**),
- number of pages sent or received,
- call duration,
- incoming or outgoing results: noted **CORRECT** if properly transmitted,
or
information codes for special calls (polling, manual subscribers, etc.)
- reason for call error (example: your subscriber does not answer)

To print the logs:

▼52 - PRINT / LOGS

- 1 Press on ▼ and enter **52** with the digital keypad.

The printing of the logs starts.



The incoming and outgoing logs are printed on the same page.

Print the list of setups



The printing is not possible on A5 paper format.

To print the list of setups:

▼54 - PRINT / SETUP

- 1 Press on ▼, enter **54** with the digital keypad.

The printing of the list of setups starts.

Font printing

You can print the list of fonts installed on your terminal at any time.

To print PCL fonts:

▼57 - PRINT / PCL FONTS

To print SG Script fonts:

▼58 - PRINT / SGSCRIPT FONTS

Lock the machine

This function prevents non-authorized people from accessing the machine. An access code will be required every time someone wants to use the device. After each use, the device will lock automatically. Before that you have to enter a lock code.



If a code is already registered, enter the old code before typing the new one.

▼811 - ADVANCED FCT / LOCK / LOCKING CODE

- 1 Press on ▼, enter **811** with the digital keyboard.
- 2 Enter your lock code (4 digits) with the keyboard, confirm with **OK**.
- 3 Enter again your lock code (4 digits) with the keyboard, confirm with **OK**.
- 4 Quit this menu by pressing the  button.

Lock the keyboard

Everytime you use your machine, you will have to enter your code.

▼812 - ADVANCED FCT / LOCK / LOCK KEYBD.

- 1 Press on ▼, enter **812** with the keyboard.
- 2 Enter the lock code and confirm with **OK**.
- 3 With the buttons ▼ or ▲, choose **WITH** and confirm with **OK**.
- 4 Quit this menu by pressing the  button.

Lock the numbers

This function locks dialling and the numerical keypad is disabled. Transmissions are only possible from numbers included in the directory.

To access the number interlocking option:

▼813 - ADVANCED FCT / LOCK / LOCK NUMBER

- 1 Enter the four-digit interlock code with the keypad.
- 2 Press key **OK** to confirm.
- 3 With keys ▼ or ▲ of the navigator, select the option **DIRECT ONLY**.
- 4 Press key **OK** to confirm.
- 5 Quit this menu by pressing the  button.

Lock the SMS service

This function prevents access to the SMS service.

To access the SMS service locking menu:

▼815 - ADVANCED FCT / LOCK / LOCK SMS

- 1 Enter the four-digit locking code with the numerical keypad.
- 2 Press key **OK** to confirm.
- 3 Enter the four-digit locking code again to confirm it.
- 4 Press key **OK** to confirm.

When a code is already registered in the machine, you will have to enter this registered code first before you can type and register a new one.

Read the counters

This function allows you to view the activity counters for your machine at any time.

According to your needs, you can read the counters for:

- sent pages,
- received pages,
- scanned pages,
- printed pages.

Sent pages counter

To view the number of pages sent from your machine:

▼821 - ADVANCED FCT / COUNTERS / SENT PAGES

- 1 Press on ▼, enter **821** with the keyboard.
- 2 The number of sent pages appears on the screen.
- 3 Quit this menu by pressing the  button.

Received pages counter

To view the number of pages received on your machine:

▼822 - ADVANCED FCT / COUNTERS / RECEIVED PG

- 1 Press on ▼, enter **822** with the keyboard.
- 2 The number of received pages appears on the screen.
- 3 Quit this menu by pressing the  button.

Scanned pages counter

To view the number of pages scanned on your machine:

▼823 - ADVANCED FCT / COUNTERS / SCANNED PAGE

- 1 Press on ▼, enter **823** with the keyboard.
- 2 The number of scanned pages appears on the screen.
- 3 Quit this menu by pressing the  button.

Printed pages counter

To view the number of pages printed on your machine:

▼824 - ADVANCED FCT / COUNTERS / PRINTED PG

- 1 Press on ▼, enter **824** with the keyboard.
- 2 The number of printed pages appears on the screen.
- 3 Quit this menu by pressing the  button.

Display the consumables status

You can read at any time the remaining toner in the cartridge. This level appears in percentage.

▼86 - ADVANCED FCT / CONSUMABLES

- 1 Press on ▼, enter **86** with the keyboard.
- 2 The available toner percentage appears on the screen.
- 3 Quit this menu by pressing the  button.

Calibrate your scanner

You can do this operation when the quality of photocopied documents is not satisfactory anymore.

▼80 - ADVANCED FCT / CALIBRATION

- 1 Press on ▼, enter **80** with the keyboard, confirm with **OK**.
- 2 The scanner is triggered and a calibration is done automatically.
- 3 At the end of the calibration, the machine comes back to the screen saver.

Directory

Your multifunction machine lets you create a directory by memorising subscriber records and subscriber lists. Your machine can store up to 250 subscriber records, which you can group in 20 subscriber lists.

For all subscriber records or subscriber lists you may create, consult, modify or delete contents. You can also print the directory.

Furthermore, your machine lets you create and manage your phone directory from your PC Kit. For more information on this feature, refer to chapter **PC Features**, page 42.

Creating subscribers record

To create subscribers record:

▼ 11 - DIRECTORY / NEW CONTACT

- 1 Press on ▼, enter **11** with the digital keypad.
- 2 Enter the **NAME** of your contact with the alphanumerical keypad (20 characters maximum), confirm with **OK**.
- 3 Enter the **TEL** number of your contact with the digital keypad (30 digits maximum), confirm with **OK**.
- 4 Choose the **RECORD NO** from your directory with the digital keypad or accept the displayed number, and confirm with **OK**.
At this stage, you may associate an e-mail address or an FTP address to your subscriber. If you do not wish to do so, confirm with **OK** and refer to step 5.

To associate an e-mail address:

- Enter the E-Mail address of your subscriber and confirm with **OK**.
- Define the attachment format (Image or PDF) then confirm with **OK**.
- Refer to step 5.

Or to associate an FTP address :

- Do not enter the e-mail address and confirm with **OK**.
- Enter the FTP address of the contact (for example: 134.1.22.9), then confirm with **OK**.
- Enter the FTP user name (for example: Durand) then confirm with **OK**.
- Enter the password of the FTP user, then confirm with **OK**.
- If necessary, enter the file destination directory (when this field is not completed, the files are stored directly under the root) of the FTP server (for example: server name / Durand). Confirm with **OK**.
- Define the attachment format (Image or PDF) then confirm with **OK**.
- Refer to step 5.

- 5 Select **W. ASSOC. KEY** if you want to assign a shortcut key (letter) to your subscriber record. The first available letter appears, use ▼ or ▲ to choose another letter. Confirm with **OK**.
- 6 Select the appropriate transmission **RATE** to send faxes among the values 2400, 4800, 7200, 9600, 12000, 14400 and 33600 using ▼ or ▲. Confirm with **OK**.
The maximum speed can be used if the telephone line is of good quality, meaning appropriate, without echo.



If your multifunction machine is connected to a PABX, you may insert a pause for dial tone after the outgoing local prefix dialling. To do so, insert the character "/" after the local prefix.

Creating subscribers list

To create subscribers list:

▼ 12 - DIRECTORY / NEW GROUP

- 1 Press on ▼, enter **12** with the digital keypad.
- 2 Enter the **LIST NAME** with the alphanumerical keypad (20 characters maximum), confirm with **OK**.
- 3 **CALLED NUMBER**: use ▼ ou ▲ to select from existing records the contacts of your list and confirm with **OK**. Repeat this operation for each subscriber you want to add to your list.
- 4 Enter the **LIST NUMBER** assigned to your list with the digital keypad or accept the displayed number, and confirm with **OK**.



In the directory, the letter G placed next to a name identifies a subscribers group.

Modifying a record

To modify a subscribers record or list:

▼ 13 - DIRECTORY / MODIFY

- 1 Press ▼, enter **13** with the digital keypad.
- 2 With ▼ or ▲, browse the directory and select the record or list you want to modify by pressing **OK**.
- 3 With ▼ or ▲, browse the entries of the selected record or list. Press on **OK** when the entry you want to modify appears on screen.
- 4 The cursor appears at the end of the line. Press on **C** to delete characters.
- 5 Enter the new entry and confirm with **OK**.
- 6 Repeat the operations for each line you want to modify.

Deleting a record or a list

To delete a subscribers record or list:

▼ **14 - DIRECTORY / CANCEL**

- 1 Press on ▼, enter **14** with the keypad.
- 2 With ▼ or ▲, browse the directory and select the record or list you want to delete by pressing **OK**.
- 3 Press on **OK** to confirm the deletion.
- 4 Repeat the operations for each record or list you want to delete.

Printing the directory



The printing is not possible on A5 paper format.

To print the directory:

▼ **15 - DIRECTORY / PRINT**

- 1 Press on ▼, enter **15** with the keypad.

The printing of the directory starts, in alphabetical order.

Local network settings

You may connect your multifunction terminal to an Ethernet or a wireless network.

However, practical knowledge of your computer configuration is required to set up a network.

Selecting the type of your local network

This parameter allows you to configure your terminal accordingly to the type of network you will install it in.

▼ 26 - SETUP/LOCAL NETWORK

- 1 Select the desired network type using the ▼ or ▲ buttons
 - WLAN if using a wireless network
 - LAN ETHERNET if using a wired network
- 2 Confirm with **OK**.

Ethernet network settings (Model B2540)

Automatic configuration

We recommend that you carry out a manual configuration of your terminal. The automatic configuration of the local network settings may be considered, if your local network features a DHCP or BOOTP server that can dynamically assign addresses to the peripheral devices present on the LAN.

To automatically configure the local network settings:

▼ 271 - SETUP/LAN ETHER/IP CONFIG.

- 1 Choose **Automatic** and press **OK** to confirm. The terminal scans the local network for a DHCP or BOOTP server that can assign it its settings dynamically (the message Self-conf is displayed).
- 2 Once the message Self-conf has disappeared, check for the IP Address, Sub-network mask and Gateway address. If these are missing, you should carry out a manual configuration (see below).

Manual configuration

To configure your terminal manually, you should obtain the usual information used to set a peripheral device (IP address, sub-network mask, network and gateway address).

To configure the local network setting manually:

▼ 271 - SETUP/LAN ETHER/IP CONFIG.

- 1 Choose **Manual** and press **OK** to confirm.

IP address

▼ 272 - SETUP/LAN ETHER/ADRESSE IP

- 1 Enter the IP address of your terminal and press **OK** to confirm.

Sub-network mask

▼ 273 - SETUP/LAN ETHER/MSK SS RES.

- 1 Enter the sub-network mask of your terminal and press **OK** to confirm.

Gateway address

▼ 274 - SETUP/LAN ETHER/PASSERELLE

- 1 Enter the IP address of the network gateway and press **OK** to confirm.

IEEE Address (or Ethernet address) or MAC address

▼ 275 - SETUP/LAN ETHER/IEEE ADDRESS

The Ethernet card of your terminal already has an unmodifiable, yet consultable, IEEE address.

NetBIOS names

These names, which can be used with the network options, are used to identify your terminal machine from a PC connected to a local network (for instance with the name "IMP-NETWORK-1").

▼ 276 - SETUP/LAN ETHER/NETBIOS 1

▼ 277 - SETUP/LAN ETHER/NETBIOS 2

- 1 Enter the selected name (15 characters max) and press **OK** to confirm.

Serveurs de nom

The WINS1 and WINS2 servers, used with the network options, allow access to terminals on other sub-networks by means of their NetBIOS name.

▼ 278 - SETUP/LAN ETHER/NETBIOS 1

▼ 279 - SETUP/LAN ETHER/NETBIOS 1

- 1 Enter the IP address of each server, then validate with **OK**.



If the terminal is set up in Automatic configuration mode (menu ▼ 271), these addresses can be filled in automatically by certain DHCP servers.

WLAN network

You can connect your machine to a PC using a USB cable or make a wireless connection (via radio) with a PC or network.



Beware, when you are using a wireless connection, that certain items of medical equipment, sensitive or security systems may be affected by the radio transmissions of your device; in all cases, please follow safety guidelines closely.

If you have a WLAN adaptor, you can incorporate your machine as a network printer into a radio network. This works only with an approved adaptor that you can obtain from our ordering department.

Type of radio network

A radio network or WLAN (Wireless Local Area Network) is created when at least two computers, printers or other peripheral devices communicate with each other in a network via radio waves (high frequency waves). The transmission of data in the radio network is based on the standards 802.11b and 802.11g. According to how the network is set up, it may be described as an infrastructure network or an ad-hoc network.

Radio infrastructure network

In an infrastructure network, several devices communicate via a central access point (a gateway or router). All data is sent to the access point (gateway or router) from where it is re-distributed.

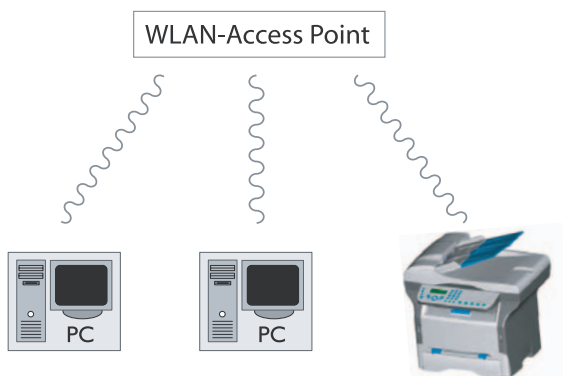

Radio ad-hoc network

In an ad-hoc network, the devices communicate directly with each other without passing through an access point. The speed of communication across the whole radio network is as fast as the weakest connection in the network. The speed of communication is also dependent on spatial distance between transmitter and receiver, as

well as the number of barriers, such as walls or ceilings.

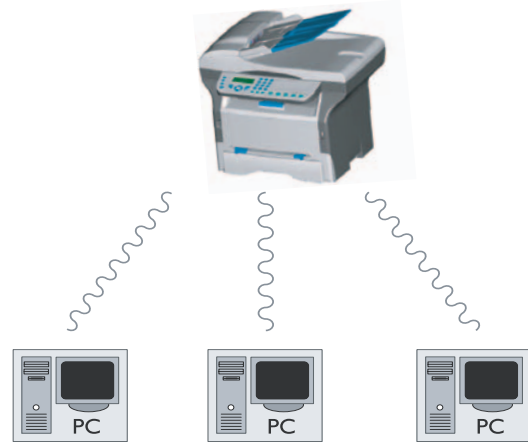

Radio networks (WLAN)

Three steps are necessary to incorporate your machine into a radio network (WLAN):

- 1 Configure the network to your PC.
- 2 Set up the parameters for your machine so that it can function in a network.
- 3 Having set up the parameters your device, install the Companion Suite LL software onto your PC with the necessary printer drivers.

The PC and all other devices must have their parameters set up to the same network as the multifunction machine. All the details needed for setting up the device, such as the network names (SSID), type of radio network, WEP key, IP address or subnetwork mask, must match the specifications of the network.



You will find these details on your PC or on the Access Point.

To find out how to set up the parameters for your PC, please consult the users' manual for your WLAN adaptor. For large networks, please seek the advice of your network administrator.



You can be sure of perfect communication if you use an approved adaptor in conjunction with your PC.

All of the latest printer drivers for the approved adaptor may be found on our website together with further information.

Connect your WLAN adaptor

Your machine belongs to a new generation of terminals that you can incorporate into a WLAN network using a WLAN USB key.

Your machine's network radio adaptor transmits data using the radio protocol IEEE 802.11g; it can also be incorporated into an existing IEEE 802.11b network.



When connecting to your machine, only use the approved adaptor. Other transmitting or receiving adaptors may damage your device.

Irrespective of whether you use your machine in an infrastructure or ad-hoc network, you must set up certain network and security parameters (for example, the Service-Set-ID (SSID) and the WEP key). These must match the network's specifications.

- 1 Plug your WLAN USB key into the USB port of your machine.



Configure your network



We recommend that the settings of your WLAN network should only be changed by a person with a good knowledge of the configuration of your computer.

Creating or rejoining a network

Before attempting to use a WLAN adaptor on your machine, you must enter the parameters that will allow a WLAN network to recognise your machine.

On your machine you will find simple instructions that guide you step by step through the set-up of your network. Just follow them!

▼ 281 - SETUP / WLAN / ASS. CONFIG.

- 1 Type in ▼, select the menu **SETUP** using the keys ▼ or ▲ and confirm with **OK**.
- 2 Select **WLAN** using the keys ▼ or ▲ and confirm with **OK**.
- 3 Select **ASS. CONFIG.** using the keys ▼ or ▲ and confirm with **OK**.
- 4 Select **NEW NETWORK** using the keys ▼ or ▲ and confirm with **OK**.



If you choose and existing network, steps 5 and 6 (and possibly 7) are carried out automatically.

- 5 **SSID** appears on the screen, enter the name of your network using the numerical keypad, pressing the keys one after the other until you obtain the name you want (32 characters maximum) and confirm with **OK**.
- 6 **AD-HOC MODE** or **INFRA. MODE** appear on the screen. Go back to the beginning of the chapter and make your choice.
Select one of these modes and confirm with **OK**.
 - If you choose **AD-HOC** mode, the sub-menu **CHANNEL** appears, enter a figure between 1 and 13 and confirm with **OK**.
- 7 **WITHOUT SECURITY** or **WITH SECURITY** appear on the screen.
Select the option you want and confirm with **OK**.
 - If you choose **WITH SECURITY** the sub-menu **WEP KEY 1** appears, enter the key number (1 to 4 maximum) that you are using on your network.



The WEP key number may be configured in the menu:

▼ 29 - SETUP / TECHNICALS / WEP KEYS
NBR

- 8 **IP CONF.: MANU** or **IP CONF.: AUTO** appear on the screen.
If you choose to set up the system manually, go to the next paragraph and enter the parameters **IP ADDRESS**, **SUBNET MASK** and **GATEWAY**.
- 9 At the end of this procedure, you return to the main menu of **ASS. CONFIG.**
- 10 Exit this menu by pressing the  key.

Referring to or changing your network parameters

Each of the parameters of your network may be changed as your network develops.

▼ 2822 - SETUP / WLAN / PARAMETERS / IP ADDRESS

- 1 Type in ▼, select the menu **SETUP** using the keys ▼ or ▲ and confirm with **OK**.
- 2 Select **WLAN** using the keys ▼ or ▲ and confirm with **OK**.

- 3 Select **PARAMETERS** using the keys \blacktriangledown or \blacktriangle and confirm with **OK**.
- 4 Select **IP ADDRESS** using the keys \blacktriangledown or \blacktriangle and confirm with **OK**.
- 5 The number of your IP address will appear in the format **000.000.000.000**. Enter the new IP address for your machine in the format displayed and confirm with **OK**.
- 6 Exit this menu by pressing the  key.

▼ 2823 - SETUP / WLAN / PARAMETERS / SUBNET MASK

- 1 Type in \blacktriangledown , select the menu **SETUP** using the keys \blacktriangledown or \blacktriangle and confirm with **OK**.
- 2 Select **WLAN** using the keys \blacktriangledown or \blacktriangle and confirm with **OK**.
- 3 Select **PARAMETERS** using the keys \blacktriangledown or \blacktriangle and confirm with **OK**.
- 4 Select **SUBNET MASK** using the keys \blacktriangledown or \blacktriangle and confirm with **OK**.
- 5 The number of your subnet mask will appear in the format **000.000.000.000**. Enter the new submask of your machine in the format displayed and confirm with **OK**.
- 6 Exit this menu by pressing the  key.

▼ 2824 - SETUP / WLAN / PARAMETERS / GATEWAY

- 1 Type in \blacktriangledown , select the menu **SETUP** using the keys \blacktriangledown or \blacktriangle and confirm with **OK**.
- 2 Select **WLAN** using the keys \blacktriangledown or \blacktriangle and confirm with **OK**.
- 3 Select **PARAMETERS** using the keys \blacktriangledown or \blacktriangle and confirm with **OK**.
- 4 Select **GATEWAY** using the keys \blacktriangledown or \blacktriangle and confirm with **OK**.
- 5 The number of your gateway will appear in the format **000.000.000.000**. Enter the new gateway for your machine in the format displayed and confirm with **OK**.
- 6 Exit this menu by pressing the  key.

▼ 2825 - SETUP / WLAN / PARAMETERS / SSID

- 1 Type in \blacktriangledown , select the menu **SETUP** using the keys \blacktriangledown or \blacktriangle and confirm with **OK**.
- 2 Select **WLAN** using the keys \blacktriangledown or \blacktriangle and confirm with **OK**.
- 3 Select **PARAMETERS** using the keys \blacktriangledown or \blacktriangle and confirm with **OK**.
- 4 Select **SSID** using the keys \blacktriangledown or \blacktriangle and confirm with **OK**.
- 5 The name of your network will appear on the screen. Enter the new name of your network and confirm with **OK**.
- 6 Exit this menu by pressing the  key.

▼ 2826 - SETUP / WLAN / PARAMETERS / MODE

- 1 Type in \blacktriangledown , select the menu **SETUP** using the keys \blacktriangledown or \blacktriangle and confirm with **OK**.
- 2 Select **WLAN** using the keys \blacktriangledown or \blacktriangle and confirm with **OK**.
- 3 Select **PARAMETERS** using the keys \blacktriangledown or \blacktriangle and confirm with **OK**.
- 4 Select **MODE** using the keys \blacktriangledown or \blacktriangle and confirm with **OK**.
- 5 The symbol **>>**, tells you that your network is in active mode.
- 6 Select one of the modes and confirm with **OK**.
 - If you choose the AD-HOC MODE, the sub-menu **CHANNEL** will appear; enter a number between 1 and 13 and confirm with **OK**.
- 7 Exit this menu by pressing the  key.



In an AD-HOC network, the devices communicate directly with each other without passing through an access point. The speed of communication across the whole AD-HOC radio network is as fast as the weakest connection in the network. The speed of communication is also dependent on spatial distance between transmitter and receiver, as well as the number of barriers, such as walls or ceilings.

▼ 2827 - SETUP / WLAN / PARAMETERS / SECURITY

This parameter allows you to make your network secure.

- 1 Type in \blacktriangledown , select the menu **SETUP** using the keys \blacktriangledown or \blacktriangle and confirm with **OK**.
- 2 Select **WLAN** using the keys \blacktriangledown or \blacktriangle and confirm with **OK**.
- 3 Select **PARAMETERS** using the keys \blacktriangledown or \blacktriangle and confirm with **OK**.
- 4 Select **SECURITY** using the keys \blacktriangledown or \blacktriangle and confirm with **OK**.
- 5 Choose **WITH** or **WITHOUT** and confirm by **OK**.
 - If you choose **WITH**, enter a password:
 - In a 64 bit security configuration, the password must contain five characters exactly.
 - In a 128 bit security configuration, the password must contain 13 characters exactly.



You may also enter the password using the hexadecimal system, if this is the case:

- For a 64 bit security configuration, the password must contain exactly 10 hexadecimal characters.
- For a 128 bit security configuration, the password must contain exactly 26 hexadecimal characters.

- 6 Exit this menu by pressing the  key.

▼ 2828 - SETUP / WLAN / PARAMETERS / HOSTNAME

The machine name allows you to identify your machine on the network via a PC (for example with the name "PRINT-NETWORK-1").

- 1 Type in ▼, select the menu **SETUP** using the keys ▼ or ▲ and confirm with **OK**.
- 2 Select **WLAN** using the keys ▼ or ▲ and confirm with **OK**.
- 3 Select **PARAMETERS** using the keys ▼ or ▲ and confirm with **OK**.
- 4 Select **HOSTNAME** using the keys ▼ or ▲ and confirm with **OK**.
- 5 Type in the desired name (15 characters maximum) and confirm with **OK**.
- 6 Exit this menu by pressing the  key.

Once your connection has been set up, you must install the network printer driver "**Laser Pro LL Network**" on your PC so that you can print your documents. Refer to the paragraph **Network connection**, page 44.

An example of how an AD-HOC network may be set up

An example of how to configure an Ad-hoc network without security protection using the following parameters:

- network name: "house"
- radio type: "ad-hoc"
- channel: "1"
- PC's IP address: "169.254.0.1"
- PC's subnetwork mask: "255.255.0.0"
- PC's gateway: "0.0.0.0"
- IP address of the multifunction machine: "169.254.0.2"
- subnetwork mask of the multifunction machine: "255.255.0.0"
- multifunction machine's gateway: "0.0.0.0"

Setting up a multifunction machine

- 1 Plug the WLAN USB key into the USB connector of the multifunction machine.
- 2 Type in ▼, select the menu **SETUP** using the keys ▼ or ▲ and confirm with **OK**.
- 3 Select **WLAN** using the keys ▼ or ▲ and confirm with **OK**.
- 4 Select **ASS. CONFIG.** using the keys ▼ or ▲ and confirm with **OK**.
- 5 Select **NEW NETWORK** using the keys ▼ or ▲ and confirm with **OK**.
- 6 **SSID** appears on the screen, enter "**house**" using the numerical keypad and confirm with **OK**.
- 7 Select the mode **AD-HOC MODE** and confirm with **OK**.
- 8 Enter "1" in the field **CHANNEL** and confirm with **OK**.

- 9 Select **WITHOUT SECURITY** and confirm with **OK**.
- 10 Select **IP CONF.: MANU** and confirm with **OK**.
- 11 Enter "**169.254.0.2**" in the field **IP ADDRESS** and confirm with **OK**.
- 12 Enter "**255.255.0.0**" in the field **SUBNET MASK** and confirm with **OK**.
- 13 Enter "**0.0.0.0**" in the field **GATEWAY** and confirm with **OK**.
- 14 At the end of this process, you return to the main menu of **ASS. CONFIG.**
- 15 Exit this menu by pressing the  key.

Once the network has been set up, the LED of the WLAN USB key should be on. You must now set up the PC.

Setting up the PC

For this section, refer to the instructions supplied by the manufacturer of the WLAN USB key to help you to find and join the "house" network.

- 1 You may need to install the software for the WLAN USB key on the PC, if this has not already been done.
- 2 Plug WLAN USB key into a USB port on the PC.
- 3 Use the software of the WLAN USB key to detect the network.
- 4 Join the network "**house**" once this has been detected.
- 5 Now set up the WLAN network connection of your PC.



To guide you through this stage, refer to the paragraph "Setting the parameters for a connection" in the manufacturer's instructions.

To do this, you must configure the element **Protocol Internet (TCP/IP)** for the WLAN connection that has been created. If this element is set up in such a way as to obtain an IP address automatically, you must change it to manual mode to set up the TCP/IP address ("169.254.0.1" in our example), the subnet mask ("255.255.0.0" in our example) and the default gateway ("0.0.0.0" in our example).

- 6 Enter **OK**.

Message service (Model B2540)

Your terminal lets you send and receive emails via your local network.

To do so, you must connect your terminal to a local network. You must also configure the message service settings.

Information required to set up message service

Your network administrator must provide you the following elements:

- message service identifier
- message service password
- email address
- servers' identifiers (SMTP, POP, DNS1 and DNS2)

Configuring initialisation parameters

▼91 - E-MAIL / SUPPLIER

- 1 Select the **LOCAL NETWORK** from the list and confirm with **OK**.



Choosing **No Access** disables access to local network functions.

▼921 - E-MAIL / INIT ETHERNET / MESS. SERV

- 1 Enter Email Identifier, press **OK**.
- 2 Enter Email Password, press **OK**.
- 3 Enter E-mail Adr, press **OK**.

Access to servers parameters

▼922 - E-MAIL / INIT ETHERNET / SERVERS

- 1 Enter Smtpl, press **OK**.
- 2 Enter Pop3, press **OK**.
- 3 Enter Dns 1 (primary), press **OK**.
- 4 Enter Dns 2 (secondary), press **OK**.

Access to SMTP authentication parameters

▼- 923 - E-MAIL / INIT ETHERNET / SMTP AUTHENT.

- 1 In the **ACTIVATION** menu, select **WITH** to activate **SMTP** authentication then validate with **OK** key.
- 2 In the **PARAMETERS** menu, select **ID.MESS.SERV** to keep the same identification

parameters as in the messaging service or **AUTHENT. SPEC.** to define other identification parameters, then validate by pressing **OK** key.

- 3 When you select **AUTHENT. SPEC.**, carry out the two following operations:
- 4 Enter the **IDENTIFIER** then validate with **OK** key.
- 5 Enter the **PASSWORD** then validate with **OK** key.

Sending an E-Mail

- 1 Place the document to be copied in the automatic document feeder, face printed on the top.
or
Place the document to be copied face down on the glass, respecting the indications around the glass.
- 2 Enter the addressee's E-mail address or choose your dialling mode.
- 3 Enter the address of who you want to receive a copy of the document (CC:), and press **OK** to confirm.
- 4 Enter the object for mail (80 characters max.) and press **OK**.
- 5 Enter the text with the alphabetical keypad (100 lines of 80 characters) and confirm with **OK**.
To go to the next line, use key .
- 6 Press **OK** to confirm.
- 7 Select **B&W SCAN** to send a black and white document or **COLOUR SCAN** to send a color document, and validate with **OK** key (this setting can be changed at any time during the send procedure, using the colour key).
- 8 Enter the name of the attachment and validate with **OK** key.
- 9 If necessary, change the attachment format: **PDF** or **IMAGE** and validate with **OK** key.
- 10 If you have started to scan with the flat scanner, the unit will scan the other pages. Put your second page to scan, select **NEXT** and validate with **OK**.
- 11 Press **OK** to confirm.
- 12 Set contrast and resolution if necessary.
The document is scanned and the mail sent to memory. It will be sent during the next connection to the local network.

Sending an E-mail text

You can send a typed message to an E-mail mailbox.

Access through the menu. :

▼- 95 - E-MAIL / SEND EMAIL

- 13 Enter the addressee's E-mail address or choose your dialling mode.
- 14 Enter the address of who you want to receive a copy of the document (CC:), and press **OK** to confirm.
- 15 Enter the object for mail (80 characters max.) and press **OK**.

- 16 Enter the text with the alphabetical keypad (100 lines of 80 characters) and confirm with **OK**.
To go to the next line, use key .
- 17 Press **OK** to confirm.
The mail is memorised and will be sent at the next connection to the local network.

Scan to FTP

The scan to FTP function enables you to put your TIFF, JPEG and PDF files in an FTP server, for example, for archiving.
To connect to the FTP server, you must know the name of the FTP user and the PASSWORD.
When sending files, the machine connects to the FTP server using the defined connection parameters.

Simply put the file in an FTP server

- Place the document to be copied in the automatic document feeder, face printed on the top.
or
Place the document to be copied face down on the glass, respecting the indications around the glass.
- Press key PC. A choice screen is displayed.
- Select Scan to FTP with keys ▲ or ▼ then press **OK**.
- Enter the FTP address of the server or select it from the directory by pressing the key.
- Enter the name of the FTP user (operation prohibited when the address is in the directory).
- Enter the password of the FTP user (operation not necessary when the address is selected in the directory).
- Validate with **OK** key.
- Select **B&W SCAN** to send a document in black and white or **COLOUR SCAN** to send a document in colour. Validate with **OK** key (this setting may be changed at any time during the send procedure with the colour key).
- Enter the name of the attachment and validate with **OK** key.
- If necessary, change the attachment format: **PDF** or **IMAGE** and validate with **OK** key.

If you have started to scan with the flat scanner, the unit will scan the other pages. Put your second page to scan, select **NEXT** and validate with **OK**.

Connection configuration

The settings are divided into several categories:

- the **standard settings** define the connection type and frequency to the local network as well as the transmission type for your documents,
- the **E-mail sorting** defines treatment for all stored E-mail messages received.

Standard settings

Your machine has two types of settings that let you define:

- The type and frequency of the connection** to your ISP.

SET TIMES	an Internet connection is established every day at 9:00 am, 12:30 am and 5:00 pm ^a .
PERIODIC	an Internet connection is established every 3 hours ¹ (default value).
ON DEMAND	an Internet connection is established at your request by IMMED. ACCESS .

- To avoid Internet access saturation, the automatic connection will occur in reality 12 minutes, give or take, around the requested time.

- Type of transmission** over the Internet.

IMMEDIATE	document transmission will occur immediately at each transmission request.
DURING CONNECTIONS	transmissions will only occur at programmed connections of SET TIMES OR PERIODIC TYPE .

At any moment you may print the settings of your machine to know their status.

Selecting the connection type

▼941 - E-MAIL / SETTINGS / CONNEC. TYPE

- Select one of the connection options among **Set Times**, **Periodic** or **On Demand** and press **OK** to confirm.

Selecting the transmission type

▼942 - E-MAIL / SETTINGS / SEND TYPE

- Select one of the send options **Immediate** or **During cnx** then press **OK** to validate..

Modifying the connection period (Periodic type)

▼943 - E-MAIL / SETTINGS / PERIOD

- With the Periodic mode, enter the new connection period by means of the numerical keypad (between 00:01 am and 11:59 pm) and press **OK** to confirm. A local network connection will be established every three hours (default value).

Modifying the connection time(s) (Set Times type)

▼943 OK - E-MAIL / SETTINGS / TIME STTINGS

- After selecting the Set Times mode, use the ▲ and ▼ keys to place the cursor under the figure to be modified. Enter the new connection time(s) by means of the numeric keypad (value between

00:01 and 23:59) and validate with the **OK** key.

Selecting the print mode for the deposit notice

▼944 - E-MAIL / SETTINGS / DEPOSIT NOTICE

- 1 Select one of the deposit notice options With, Without, Always or On Error and press **OK** to confirm.

Printing the Internet settings

▼946 - E-MAIL / SETTINGS / PRINT

The Internet settings are printed. These settings may also be printed together with all the other settings of your machine (refer to paragraph **Printing the logs**, page 28).

Mail sorting

This function lets you choose the mode for all Internet documents stored in your mail box.

You have three choices:

- **F@x only**, lets you poll and print E-Mails in your machine.
- **PC only**, lets you keep your E-Mails in you mailbox for later use with a computer (no E-Mail poll),
- **Share PC** lets you:
 - if your PC and fax have two different addresses, transfer all mails or only those with attachments to a PC,
 - if your PC and fax share the same address, use the fax as a printer for E-Mails for the PC.

▼ 96 - E-MAIL / SORT MESSAGES

F@X Only mode

- 1 Select option **F@x only** and press **OK** to confirm.

All E-Mails are polled and printed.

PC Only mode

- 1 Select option **PC only** and press **OK** to confirm.

The E-mails are neither polled nor printed and they may be used with a computer.

At each connection, the number of E-mails in your mailbox is displayed on the screen.

Share PC mode

- 1 Select option **Share PC** and press **OK** to confirm.

You may choose to transfer your E-mails to a PC or use the fax as an E-mail printer.

To transfer the E-Mails to a PC:

- 2 Select option **With PC Trans.** and press **OK** to confirm.
- 3 Enter the E-Mail address of the computer you wish to transfer your E-Mail and press **OK** to confirm.
- 4 Select your option from the table below and press

OK to confirm.

Menu	Description
SEND ALL MAILS	All E-Mails are sent to the PC.
UNUSABLE ATTAC	The fax machine polls and prints the usable E-mails and transfers to the PC mailbox all the E-mails containing attachments it cannot use.

To use the fax as an E-Mail printer:

- 1 Select option **W/O PC Trans** and press **OK** to confirm.
- 2 Select your option from the table below and validate with **OK**.

Menu	Description
DELETE MAILS	The E-mails opened and read by the fax (w/o attachment) are erased after the fax has printed.
SAVE MAILS	The E-mails opened and read by the fax are not erased.

At each connection, the number of E-mails still present in your mailbox are displayed on the screen.

USB memory key

You can connect a USB memory Key on the front side of your machine. The files stored in TXT, TIFF and JPEG formats will be analysed and you will be able to use the following actions:

- print the stored files contained in your USB memory key¹,
- delete the files contained in your USB memory key,
- run an analysis on the contents of the inserted USB memory key,
- digitalise a document on your USB memory key,
- fax archiving (see section **Rerouting fax messages to a USB memory key**, page 18).

Use of the USB memory key



Always respect the insertion way when you connect a USB memory key to the machine. Do not disconnect your USB memory key while the machine is reading its contents or writing contents.



Print your documents



The printing is not possible on A5 paper format.

You can print the stored files or a list of the files located in the USB memory key.

Print the list of files located in the key

To print the list of files located in the key:

▼ 01 - MEDIA / PRINT DOC. / LIST

- 1 Insert the USB memory key on the front side of the machine respecting the insertion way. **MEDIA ANALYSIS** appears on the screen.
- 2 Select **PRINT DOC.** with the ▼ or ▲ buttons and confirm with **OK**.
- 3 Select **LIST** with the ▼ or ▲ buttons and confirm with **OK**.

1. It may be possible that some TIFF files of your USB memory key cannot be printed due to data format limitation.

- 4 The list is shown in a table with the following information:
 - the analyzed files are indexed in an incremental 1 by 1 order,
 - the files name with their extension,
 - the date of the files last save,
 - the files size in Kbytes.

Print the files located in the key

To print the files located in the key:

▼ 01 - MEDIA / PRINT DOC. / FILE

- 1 Insert the USB memory key on the front side of the machine respecting the way of insertion. **MEDIA ANALYSIS** appears on the screen.
- 2 Select **PRINT DOC.** with the ▼ or ▲ buttons and confirm with **OK**.
- 3 Select **FILE** with the ▼ or ▲ buttons and confirm with **OK**.
- 4 You have three possibilities to print your files:
 - **ALL**, to print all the files located in the USB memory key. Select **ALL** with the ▼ or ▲ buttons and confirm with **OK**. The printing is started automatically.
 - **SERIES**, to print a series of files located in the USB memory key. Select **SERIES** with the ▼ or ▲ buttons and confirm with **OK**. **FIRST FILE** and the first indexed file appears on the screen. Select with the ▼ or ▲ buttons the first file of the series to print and confirm with **OK**. A star (*) appears on the left side of the file. **LAST FILE** appears on the screen. Select with the ▼ or ▲ buttons the last file of the series to print and confirm with **OK**.

Press the  button.

COPIES NUMBER appears on the screen, enter the desired number of copies with the digital keypad and confirm with **OK**. Select the printing format: **A4** or **10x15** and confirm with **OK**. Select the printing format: **THICK** or **NORMAL** and confirm with **OK** to start printing.

- **SELECTION**, to print one or several files located in the USB memory key. Select with the ▼ or ▲ buttons the file to print and confirm with **OK**. A star (*) appears on the left side of the file. Repeat this step for each file you want to print.

Press the  button.

COPIES NUMBER appears on the screen, enter the desired number of copies with the digital keypad and confirm with **OK**. Select the printing format: **A4** or **10x15** and

confirm with **OK**.

Select the printing format: **THICK** or **NORMAL** and confirm with **OK** to start printing.

- 5 Quit this menu by pressing the  button.

Delete your files located in the key

You can delete files located in your USB memory key.

▼ 06 - MEDIA / DELETE / MANUAL

- 1 Insert your USB memory key on the front side of your machine respecting the way of insertion. **MEDIA ANALYSIS** appears on the screen.
- 2 Select **DELETE** with the ▼ or ▲ buttons and confirm with **OK**.
- 3 Select **MANUAL** with the ▼ or ▲ buttons and confirm with **OK**.
- 4 You have three possibilities to delete your files:
 - **ALL**, to delete all the files located in the USB memory key.
Select **ALL** with the ▼ or ▲ buttons and confirm with **OK**.
You come back to the previous menu.
 - **SERIE**, to delete a series of files located in the USB memory key.
Select **SERIE** with the ▼ or ▲ buttons and confirm with **OK**.
FIRST FILE and the first indexed file appears on the screen. Select with the ▼ or ▲ buttons the first file of the series to delete and confirm with **OK**. A star (*) appears on the left of the file.
LAST FILE appears on the screen, select with the ▼ or ▲ buttons the last file of the series to delete and confirm with **OK**. A star (*) appears on the left side of the file.

Press the  button.

You come back to the previous menu.

- **SELECTION**, to delete only one or several files located in the USB memory key.
Select with the ▼ or ▲ buttons the file to delete and confirm with **OK**. A star (*) appears on the left side of the file.
Repeat this step for each file you want to delete.

Press the  button.

You come back to the previous menu.

- 5 Quit this menu by pressing the  button.

Analyse the USB memory key content

After a period of inactivity, your machine will return to the main menu. To view the USB memory key again please proceed as follows:

▼ 07 - MEDIA / MEDIA ANALYSIS

- 1 Press on ▼, enter **07** with the keyboard.
- 2 The USB memory key analysis is started.
- 3 You can print or delete the detected files located in your USB memory key. Refer to the previous chapters.

Save a document on a USB memory key

This function allows you to digitise and save a document directly in a USB memory key.

- 1 Place the document to be copied face down on the glass.
- 2 Insert the USB memory key in the USB connector of your multifunction device.
The USB memory key analysis is started.
When the analysis is finished, the MEDIA menu is displayed.
- 3 Select **SCAN TO** with the ▲ or ▼ buttons then confirm with the **OK** button.

You can also access this function in two other ways:



- by pressing the **SCAN** button of the machine deck then by selecting **SCAN-TO-MEDIA**.
- By pressing the ▼ button from the screen saver then by typing **03** on the digital keyboard.

- 4 Choose the **COLOUR** between **BLACK&WHITE** and **COLOUR** with the ▲ or ▼ buttons and the button **OK**.
- 5 With the alphanumeric keyboard, give a name to the scan file (up to 20 characters) and confirm with **OK**.
- 6 Choose the scan format between **IMAGE** and **PDF**, and confirm to start the scan and the recording of the document.
IMAGE allows to have the same kind of file as a photo. **PDF** is a format for the digital documents creation.

With the **IMAGE** format, if you have selected:



- **BLACK&WHITE**, the picture will be saved in **TIFF** format.
- **COLOUR**, the picture will be saved in **JPEG** format.

The beginning button  immediately starts the scan and sends a file to the support with the parameters defined in the analysis format.

PC Features

Introduction

The Companion Suite Pro software allows the connection of a personal computer with a compatible multifunction machine.

From the PC, you can:

- manage the multifunction machine, allowing you to set it up according to your needs,
- print your documents on the multifunction machine from your usual applications,
- scan colour, grey scale or black and white documents and edit them on your PC, or process them into text using the character recognition software (OCR),

Configuration requirements

The minimum configuration requirements for your personal computer are:

Supported operation systems:

- Windows 98SE,
- Windows Millennium,
- Windows 2000 with at least Service Pack 3,
- Windows XP (Home and Pro).

Processor:

- 500 MHz for Windows 98SE,
- 800 MHz for Windows Me or 2000,
- 1 GHz for Windows XP (Home and Pro),

A CD-ROM drive

A free USB port

600 Mbytes of available disk space for the installation

RAM memory:

- 128 Mbytes minimum for Windows 98, Me, and 2000,
- 192 Mbytes minimum for Windows XP (Home and Pro).

Installation

Install the software on your PC

Turn your PC on. Open an ADMINISTRATOR account session unless working in 98SE and ME environments.

- 1 Open the CD-ROM drive, insert the installation CD-ROM and close the drive.
- 2 An installation procedure is automatically run (Auto run).
- 3 A screen titled COMPANION SUITE PRO LL appears.

This screen allows you to install and uninstall the software, access the product's user guides or browse the CD-ROM contents.

- 4 Place your cursor on PRODUCT INSTALLATION and confirm with left-click of the mouse.
- 5 The Products Installation screen appears. Place your cursor on FULL and confirm by left-click with the mouse.

The FULL installation copies on your hard disk the software required for the good execution of the Companion Suite Pro kit, which is:

- Companion Suite Pro (machine management software, printer drivers, scanner, ...),
- Adobe Acrobat Reader,
- PaperPort.



You may already be the owner of a version of the software available in the installation CD-ROM.

In this case use the CUSTOM installation, select the software that you want to install on your hard drive and confirm your choice.

The multifunction machine components only appear if your Windows Installer version is older than 2.0.

The installation resumes, a progress bar appears.

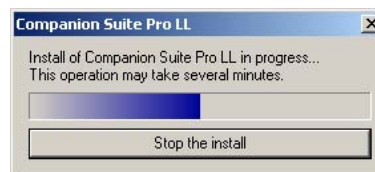

You can stop the program's installation by clicking on the STOP THE INSTALL button.

After search and analysis of the PC components and the multifunction machine's components, you need to restart your PC for the modifications to take effect. Click on the **OK** button.

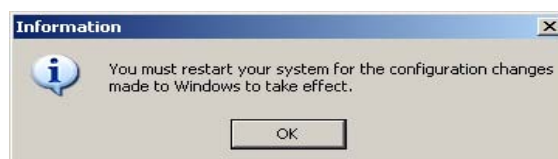

- 6 After restart, the InstallShield Wizard screen shows the progress of the assistant preparation. You can stop the procedure at any time by clicking on the **CANCEL** button.

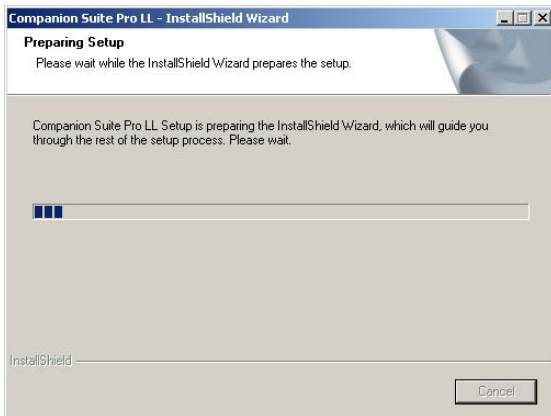

- 7 The welcome screen appears.

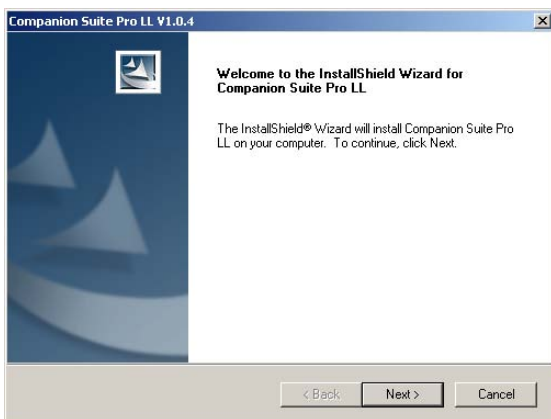

- 8 Click on the **NEXT** button to launch the installation of the COMPANION SUITE PRO kit on your PC.
9 To continue, you need to accept the proposed license agreement.



- 10 Click on the **YES** button.
11 Click on the **NEXT** button.

- 12 The final installation is ready to be executed.

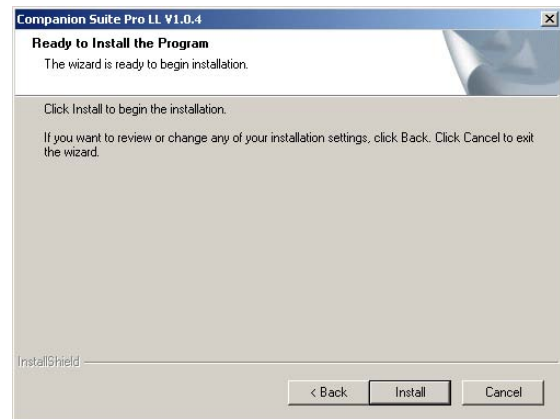

- 13 Click on the **INSTALL** button.

- 14 A screen informs you of the installation progress.

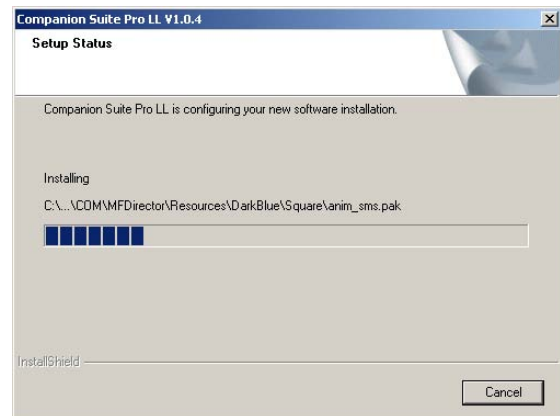

- 15 The Companion Suite Pro software is installed on your PC.

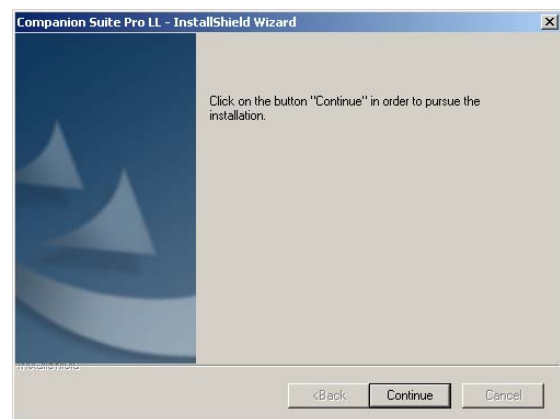

- 16 Click on the **CONTINUE** button to copy the utilities and PaperPort SE software that come along with the kit.

- 17 At the end of the installation, you need to restart your PC to update the system files.

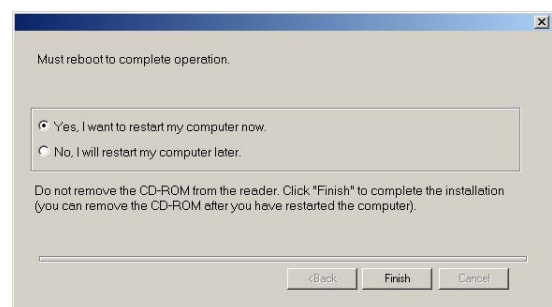

- 18 Select your choice and click on the **FINISH** button.
- 19 Your "Companion Suite Pro" kit is successfully installed on your PC.

You can start the multifunction machine's management software from the menu **START > PROGRAMS > COMPANION SUITE > COMPANION SUITE PRO LL > MF DIRECTOR** or by clicking on the icon **MF DIRECTOR** located on your desktop.



It is possible to add LAN printers without installing the Companion Suite Pro software on Windows 2000 and XP. From the Windows menu Start > Parameters > Printers and faxes, select "Add Printer" and follow the instructions on screen.

Connections

Make sure that your multifunction machine is powered off.

USB Connection

The connection between the PC and the machine requires a USB 2.0 shielded cable no more than 3 meters long.

It is recommended to install the Companion Suite Pro software first and then to connect the USB cable to your machine.



If you connect the USB cable before installing the Companion Suite Pro software the recognition system (plug and play) identifies automatically that new hardware has been added. To start your machine drivers installation, follow the instructions on screen. If a window asking about the location of the drivers pops up, then indicate the installation CD-ROM.

- 1 Locate your USB cable connectors and connect as shown below on the picture.

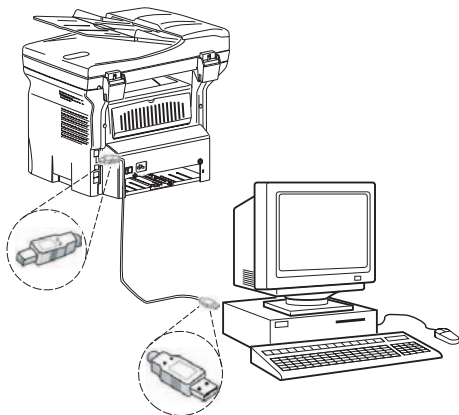

- 2 Power on your multifunction machine. The ADD HARDWARE assistant window appears.
- 3 Click on the **NEXT** button to finish the installation.
- 4 Select **FIND THE APPROPRIATE DRIVER FOR MY HARDWARE (RECOMMENDED)**. Click on the **NEXT**

button.

- 5 Select the location where the system has to look for the driver. Only the **CD-ROM DRIVES** checkbox has to be ticked. Click on the **NEXT** button. The search takes a few moments.
- 6 A window informs you that the driver has been located. Click on the **NEXT** button.
- 7 A screen informs you that the XML interface software has been installed. Click on the **FINISH** button. The **ADD HARDWARE** assistant window appears.
- 8 Click on the **NEXT** button.
- 9 Select **FIND THE APPROPRIATE DRIVER FOR MY HARDWARE (RECOMMENDED)**. Click on the **NEXT** button.
- 10 Select the location where the system shall look for the driver. Only the **CD-ROM DRIVES** checkbox has to be ticked. Click on the **NEXT** button. The search takes a few moments.
- 11 A window informs that the driver has been located. Click on the **NEXT** button.
- 12 A screen informs you that the **COMPANION SUITE PRO F@X ACTIVITIES** software has been installed. Click on the **FINISH** button.

You can now use the multifunction machine to print or scan your documents.

Network connection

You may connect your multifunction terminal to an Ethernet or a wireless network (model B2540 only).



The Companion Suite Pro LL software shall be installed to perform this operation.

- 1 Run the MF Director application by clicking on the icon located on your desktop or from the menu **START > PROGRAMS > COMPANION SUITE > COMPANION SUITE PRO LL > ADD PRINTER**.
- 2 Click on the **NEXT** button to run the installation procedure.



- 3 The next screen shows the list of compatible hardware found on the network.

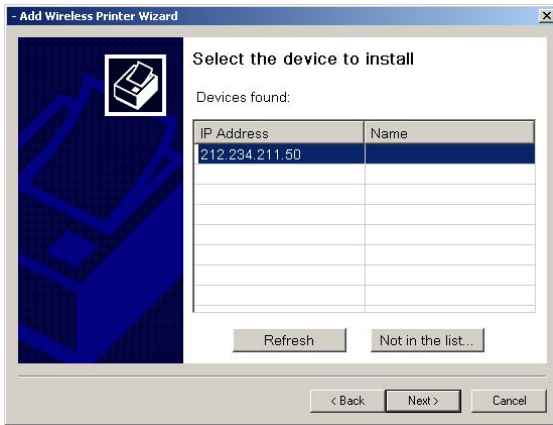

You can make another search on the network by clicking on the REFRESH button.

Remark: A hardware device may not appear in the list in which case click on the NOT IN THE LIST button. The next window appears.

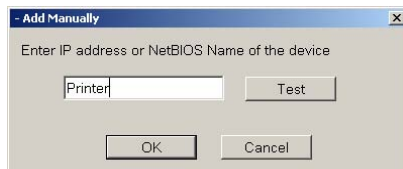

Type the IP address or the NetBIOS name of the hardware that you wish to add. You can test the connection between the PC and the hardware by clicking on the TEST button. Click on the OK button.

- 4 Select what you wish to add from the hardware list. Click on the NEXT button.
- 5 For the model B2540, with a LAN connection, you must choose one printer among the list. Nota: the PCL printer is more fast in the most case.
- 6 The next window lists the different features of the printer that are about to be installed. Click on the NEXT button.

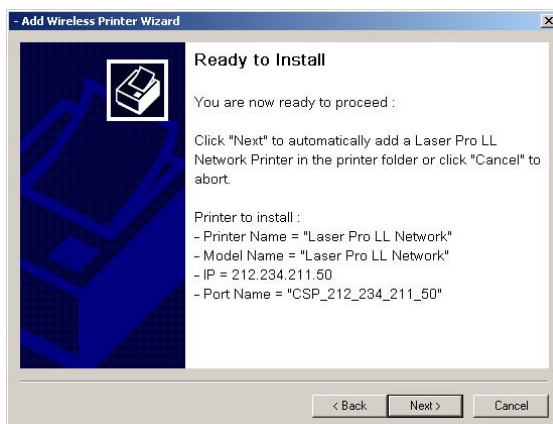

- 7 The window indicating that the installation procedure was successful pops up. Click on the FINISH button.

Uninstall the software from your PC

Run the programs removal from the menu **START > PROGRAMS > COMPANION SUITE > COMPANION SUITE PRO LL > UNINSTALL.**

- 1 A preparation screen appears.

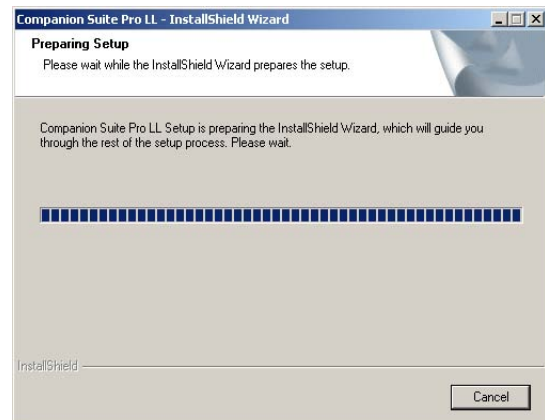

- 2 Select **REMOVE** and confirm your choice by clicking on the **NEXT** button.

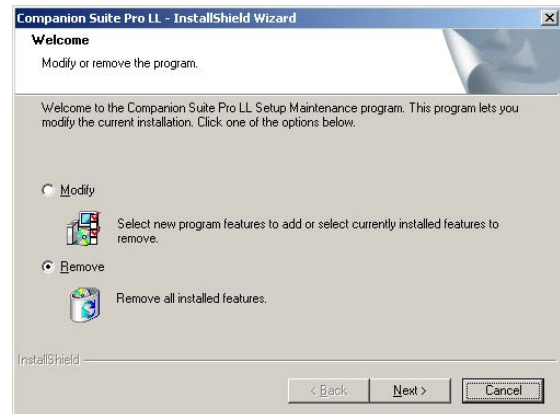

- 3 A confirmation screen appears. Click on **OK** button to continue the **COMPANION SUITE PRO LL** program removal.



- 4 A preparation screen appears. You can cancel the removal by clicking on **CANCEL**.

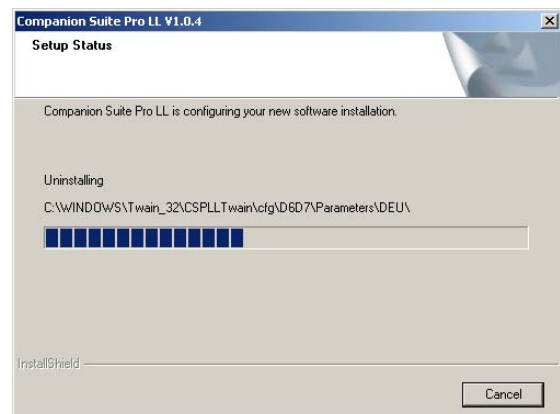

- 5 You need to restart your system at the end of the procedure. Close all open programs, select **YES, I WANT TO RESTART MY COMPUTER NOW** and click on the **FINISH** button.

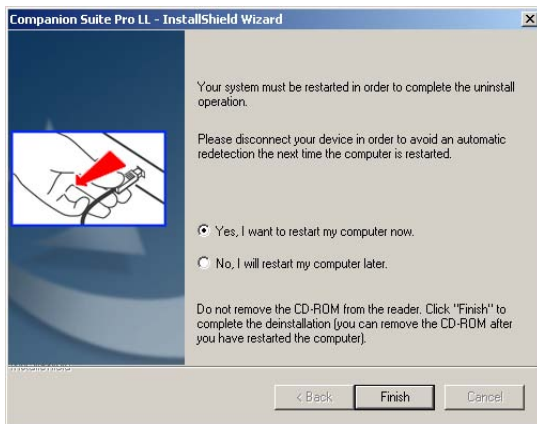

Multifunction Terminal's Supervision

The software that you have installed contains two multifunction machine management applications, MF DIRECTOR and MF MONITOR, which allow you to:

- check whether the multifunction machine is connected to your PC,
- monitor the multifunction machine activities,
- monitor the status of the multifunction machine consumables from the PC,
- quickly access the graphic editor applications, OCR etc.

To manage the multifunction machine, run the MF Director application by clicking on the icon located on your desktop or from the menu **START > PROGRAMS > COMPANION SUITE > COMPANION SUITE PRO LL > MF DIRECTOR**.

Checking the connection between the PC and the multifunction machine

To check if the connection between the devices is good, run the MF MONITOR software from the icon located on the desktop and check that the same information is displayed on the multifunction machine (for instance the date).

MF Director

This graphical Interface allows you to run the utilities and the software to manage your multifunction machine.

Graphical presentation

Run the application by clicking on the MF Director icon located on your desktop or from the menu **START > PROGRAMS > COMPANION SUITE > COMPANION SUITE PRO LL > MF DIRECTOR**.

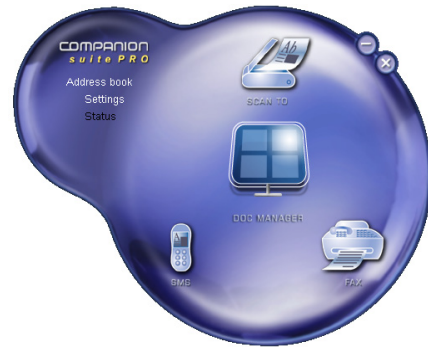

By default, MF DIRECTOR is displayed with dark blue rounded shape. You can modify its shape and color by right-clicking with the mouse.

Utilities and applications activation

The COMPANION SUITE PRO graphical interface allows you to run the following utilities and software:

- get **HELP** from the current documentation,
- run the **PaperPort** software (Doc Manager).

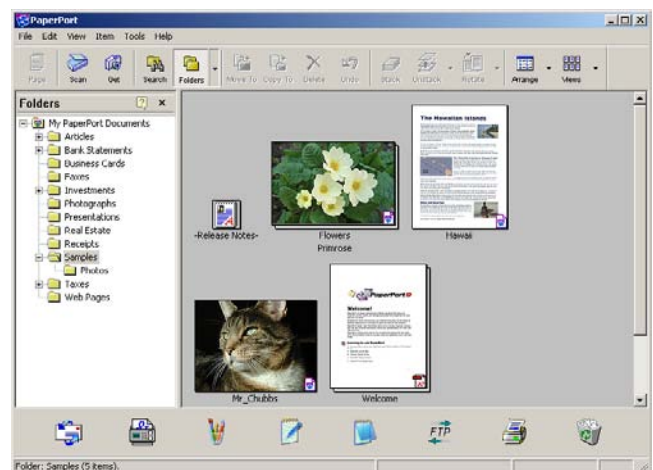

To run a software or utility contained in the COMPANION SUITE PRO kit, place the cursor on it and left-click with the mouse.

MF Monitor

Graphical presentation

Run the application by clicking on the MF Monitor icon located on your desktop or from the menu **START > PROGRAMS > COMPANION SUITE > COMPANION SUITE PRO LL > COMPANION MONITOR**.

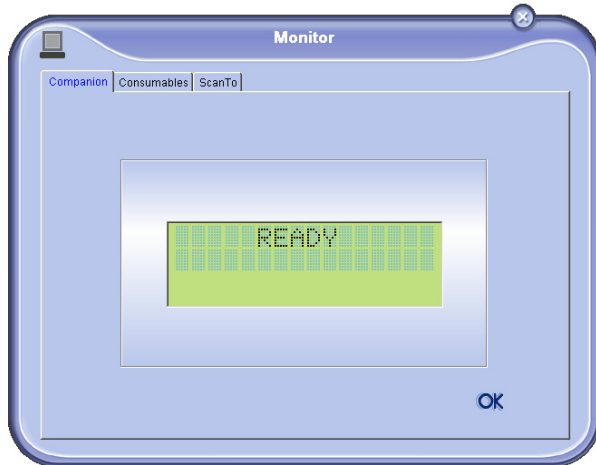

From this screen you can monitor the information or configure your multifunction machine from the tabs:

- **COMPANION:** Presents the multifunction machine screen.
- **CONSUMABLES:** Displays the consumables status.
- **SCAN TO:** Scan Mode and Resolution parameters setup, these parameters will be taken into account when clicking on the **SCAN** button from the machine.

Display the consumable status

The following information will be available from the Consumables tab:

- current consumables status,
- number of printed pages,
- number of scanned pages.

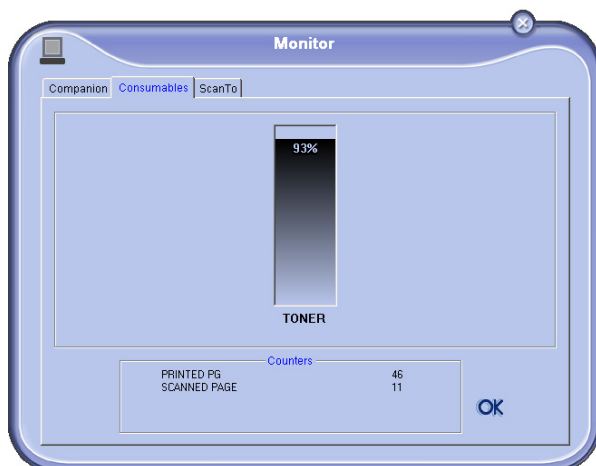

Scan To

The setup of this tab, becomes the default setup for the scanner.

Remark: The function SCAN To can only be used if the application is running. If this is not the case, activate it.

- 1 Select the Scan To tab.
- 2 Select one of the possible choices:
 - colour,
 - grayscale,
 - black and white.
- 3 Select the scanner resolution (72 dpi to 4800 dpi).
- 4 Confirm your choices by clicking on the **OK** button.

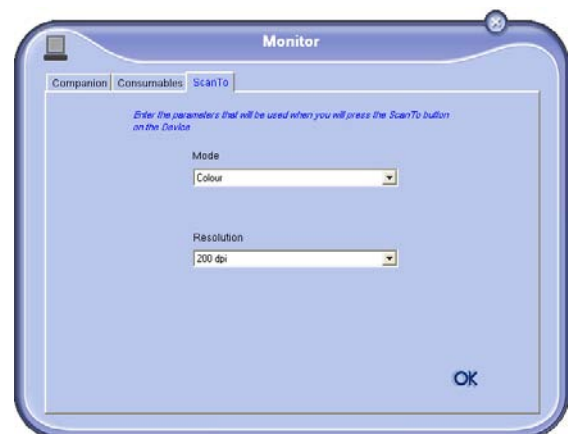

Companion Suite Pro LL functionalities

Document analysis

The document analysis can be carried out in two ways:

- either by the SCAN TO function (application accessible from the MF Director window or from the SCAN button from the machine),
- or directly from a TWAIN standard compatible application.

Analysis with Scan To

Run the application by clicking on the MF Director icon located on your desktop or from the menu **START > PROGRAMS > COMPANION SUITE > COMPANION SUITE PRO LL > MF DIRECTOR**.

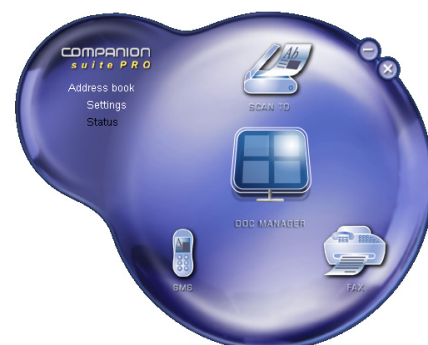

- 1 Left-click with the mouse on the **SCAN To** graphical image or click the **SCAN** button from your machine.
- 2 You can follow the ongoing digitisation on a screen.



- 3 At the end of the digitisation, the scanned picture appears in the PaperPort window.

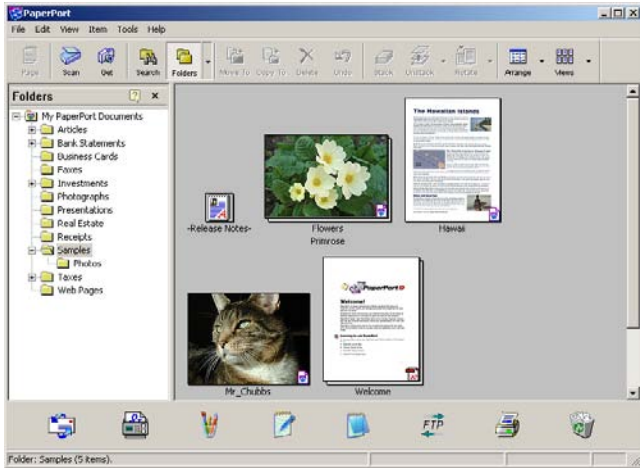

If the PaperPort software is not installed on your hard drive, the scanned picture will appear on your desktop in TIFF format.

Analysis from a TWAIN compatible software

- 1 Run the picture editor application and then run the acquisition command.
The document analysis window appears.
- 2 Setup the parameters (contrast, resolution, ...) before starting the digitisation.
- 3 Once the document is digitised, you can archive it or edit it.

Character recognition software (OCR)

The character recognition function allows to create a usable data file for desktop applications from a hardcopy document or from a picture.

The character recognition only works for printed characters, such as printer outputs or typed text. Nevertheless you can request for a handwritten text block to be kept intact (a signature for instance) by outlining it.

Given your machine environment and the character recognition from your machine, the OCR is done with a Drag&drop of a document from the PaperPort to the Notepad icon.



For more details about the usage of this software, check the on-line help of the product.

Printing

You have the possibility to print your documents via the USB connection or the Wifi connection.

During the installation of the software, the **LASER PRO LL** printer driver will be installed automatically onto your pc. This will allow you to print your documents on the machine via the USB connection.

The **LASER PRO LL NETWORK** printer driver allows to print via the wireless connection. This driver is installed when you add a network printer.

Printing with the multifunction machine

To print a document with the machine from your PC is like printing a document in Windows (use the **PRINT** command from the **FILE** menu of the currently open application on the screen). Select the **LASER PRO LL** printer to print via the USB connection or the **LASER PRO LL NETWORK** printer to print via the Wifi connection.



The **LASER PRO LL** printer becomes the default printer when the Companion Suite Pro software is installed.

Address book

The address book enables you to store the numbers of the contacts you call the most frequently. The purpose of this function is to facilitate dialing your contact's number when you want to send an SMS or fax. If you want, you can print the list of numbers stored in the Directory.

You also have the possibility of creating groups of contacts from the Address book. Like this, you can group together all contacts from, for example, a given company or the same service, etc, to which you frequently send common documents.

Add a contact to the terminal address book

- 1 Click on the link **ADDRESS BOOK** of the window **MF DIRECTOR**.

The address book is displayed on the screen.

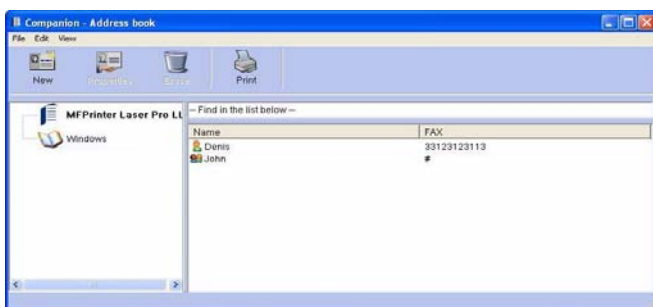

- 2 Select the terminal address book.
- 3 Click on **NEW** and select **CONTACT** in the displayed menu.
The input window for the contact data is displayed..



- 4 Enter the contact name as well as the fax or GSM telephone number, the fax transmission rate with this person, the associated quick dial key, the E-mail address and the default transmission format (Pdf or Image). Click on **OK**.

The new contact is added to the list.

Add a group to the terminal address book

- 1 Click the link **ADDRESS BOOK** of the window **MF DIRECTOR**.

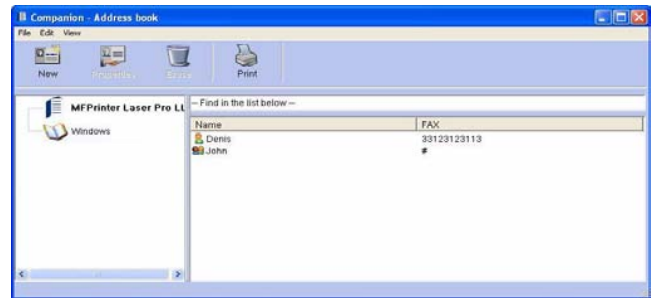

- 2 Select the terminal address book.
- 3 Click **NEW** and select **GROUP** in the displayed menu.



- 4 Enter the name of the group. The group may consist of contacts from the address book or new contacts.

1st case: group members are from the address book. Click **SELECT THE MEMBERS**.

The selection window is displayed.

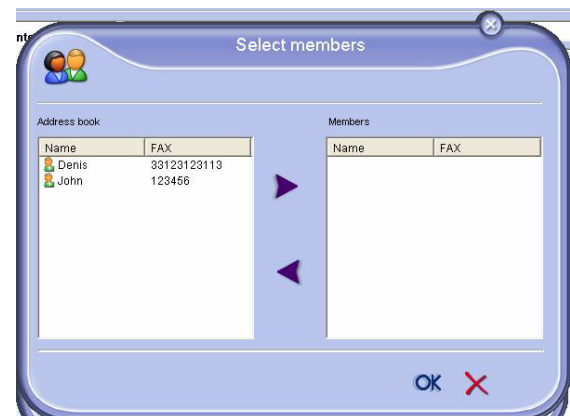

Select a contact or a group in the zone **ADDRESS BOOK**, click on ► (to add a contact to the group you can also double click on it).
Click on **OK**.

2nd case: adding new contacts.

Click on **NEW** then add the personal data of the new contact, as in the procedure for adding a contact.

- 5 As soon as the group is complete, click on **OK**.

The new group is added to the list.

Manage the address book

When you are working in the directory, you can perform different operations:

- print a list of contacts in your address book,
- delete a contact or a group in your address book,
- search for a contact or a group of contacts in the address book using the first letters of the name,
- check the datasheet of a contact or a group in order to modify it.

Modify the information related to a contact

- 1 Select the contact whose data you want to modify, using the mouse.
- 2 Click on **PROPERTIES**.
- 3 Make the necessary changes in the window **ADDRESS BOOK**.
- 4 Click on **OK**.

Modify a group

- 1 Select the group in the address book list.
- 2 Click on **PROPERTIES**.
- 3 Make the necessary changes.
- 4 Click on **OK**.

Delete a contact or a group from the address book

- 1 Select the name of the contact or the name of the group you want to delete, using the mouse.
- 2 Click on **DELETE**.



When a contact is deleted from the directory, it is automatically deleted from any group in which it may be included.

Print the address book

- 1 Click on **PRINT**.
The list of the address book is printed on the terminal (if no contact is selected).

Import or export a directory

Import a directory

Importing a directory makes it possible to exchange address book entries between two devices without having to enter contacts one by one manually. Directories can be imported from files in EAB format. EAB files are automatically generated during export.

- 1 Select **IMPORT** in the menu **FILE** of the window **ADDRESS BOOK**.
- 2 Select the file to import, click on **OPEN**.

Save your address book

This operation lets you save your address book to a file in EAB format.

- 1 Select **EXPORT** in the menu **FILE** of the window **ADDRESS BOOK**.
- 2 Enter the name of the file and select the destination directory, then click on **SAVE**.

Fax communications

The fax communication enables you to:

- send documents as faxes from one of the scanners of your terminal, from the hard disk or from the screen of your PC,
- to receive fax documents,
- to monitor communications through various services: the inbox, the outbox, the sent items, the outbox log and the inbox log.

Parameters are available to modify the way your terminal works with regard to fax communications. You can modify these parameters to adapt the fax communications to your requirements. For this procedure, refer to paragraph **Fax parameters**, page 53.

Presentation of the Fax window

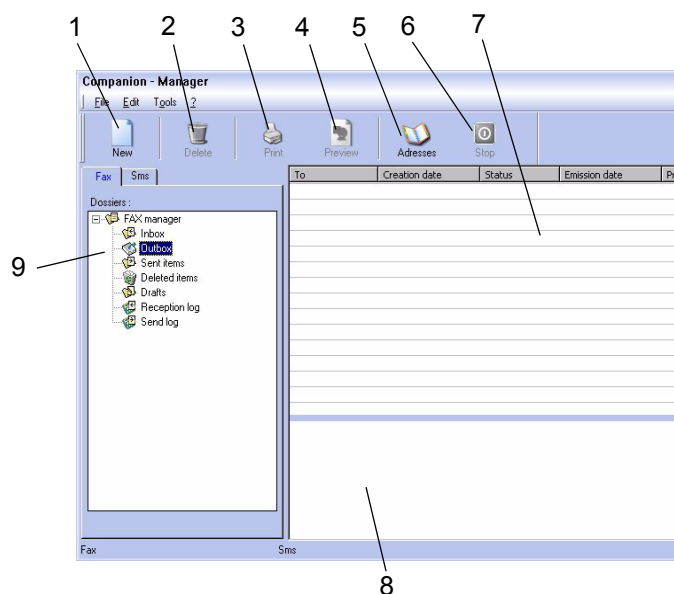



Item	Action
1	Create a new fax to send.
2	Delete a fax using one of the fax manager directories. Except for directories SEND LOG and RECEPTION LOG for which the effect of this command is to delete the entire log
3	Print a fax from one of the Fax manager directories.
4	Display a fax with the Viewer.
5	Access to the address book.
6	Stop sending a fax (only enabled for the outbox).
7	Display all faxes in the selected directory in the Fax manager.
8	Fax preview.
9	Fax manager directories.

Send a fax

Send a fax from the hard disk or the terminal

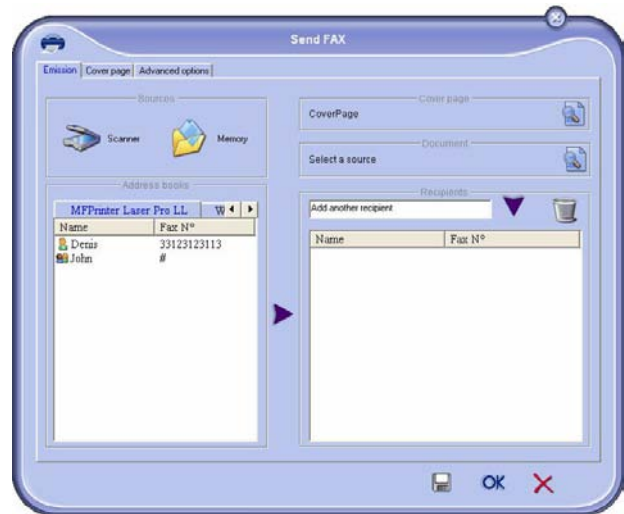
- 1 Click the icon  of the window MF DIRECTOR.
- 2 Click **NEW** then click **FAX**.



- 3 Select no zone **SOURCES**, **SCANNER** if your document is in paper format or **MEMORY** if the document is a computer file located on your hard disk (this file must be in TIFF or FAX format).
- 4 To send your fax to a contact, enter his number in the field **RECIPIENTS** and click on ▼ or select a contact (or group) from one of the directories in the field **ADDRESS BOOK** and click on the button ►. Repeat this operation as many times as necessary (use the button  to delete a contact from the list of contacts).
- 5 If necessary, adjust the advanced options (send later and resolution) in the tab **ADVANCED OPTIONS**.

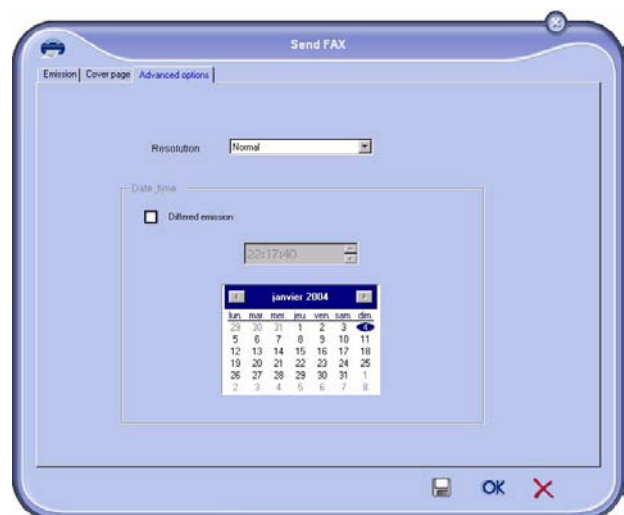

- 6 To add a cover sheet, select the tab **COVER PAGE** then click the box **WITH THE COVER PAGE**. Select the cover sheet you want to add from the pop-down menu, or create a new one. For more information, refer to paragraph **Cover sheet**, page 54.
- 7 Click **OK** to send your fax to all contacts in your list of contacts.

Your send request can then be checked, if necessary, in the outbox.

Send a fax from application

This method is used to directly send a document you have created using a desktop software without printing it beforehand.

- 1 From your desktop software, select **FILE > PRINT**.

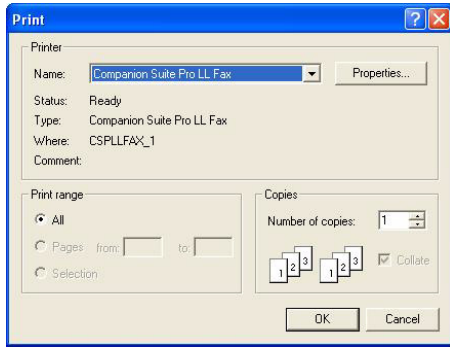

- 2 Select the printer **COMPANION SUITE FAX** and click **OK**. The fax outbox window is displayed.

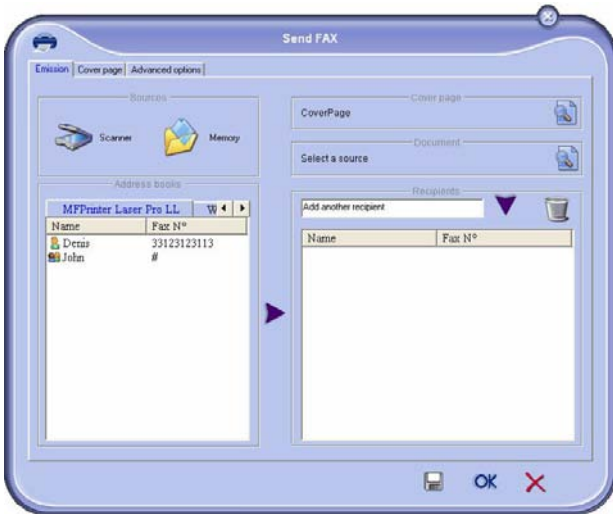

- 3 To send your fax to a contact, enter his number in the field **RECIPIENTS** and click the button ▼ or select a contact (or a group) from one of the directories in the field **ADDRESS BOOK** and click the button ▶. Repeat this operation as many times as necessary (use the button **Erase** to delete a contact from the list of contacts).
- 4 If necessary, adjust the advanced options (send later and resolution) in the tab **ADVANCED OPTIONS**.
- 5 To add a cover sheet, select the tab **COVER PAGE** then click the box **WITH THE COVER PAGE**. Select the cover sheet you want to add from the pop-down menu, or create a new one. For more information, refer to paragraph **Cover sheet**, page 54.
- 6 Click **OK** to send your fax to all contacts in your list of contacts.
- 7 Your send request can then be checked, if necessary, in the outbox.

Receive a fax

The window **MF Manager** and **MF Director** show, using different messages, the reception of a fax. The icon 📠 is displayed at the bottom of the window **MF Manager** and the icon 📡 appears in the task bar.

You can automatically print faxes on reception. To do this, you have to define this parameter, refer to paragraph **Fax parameters**, page 53.

Follow-up of fax communications

Follow-up of fax communications is by means of:

- an outbox,
- an inbox,
- a sent item memory,
- an outbox log,
- an inbox log.

These services enable you to always know exactly what communications are taking place on the terminal, whether sending or receiving.

The outbox and inbox logs are automatically printed when their contents fill an A4 page. After automatic printout, the terminal creates a new log.

The outbox

In the fax outbox, there are the following:

- the requests being sent,
- the send later requests,
- the requests for which one or more send attempts have already been made, and which will soon be redialed,
- the rejected requests (calls not put through).

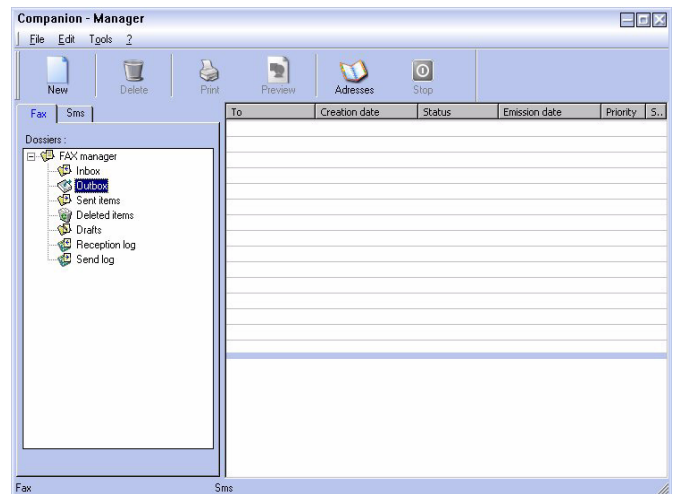

The requests are classed in the order in which they are executed.

The rejected requests are filed at the end of the list so that they are more accessible if you want to work with them (request a new send) or delete them.

The send memory (items sent)

The sent memory is used to keep all faxes you have sent. The information in the send memory is:

- the recipient of the fax,
- the date the fax was created,
- the date the fax was sent,
- the size of the fax.

The outbox log

The outbox log is used to keep a history of all fax communications (successful or rejected) that your Terminal processes. The log is printed automatically as soon as an A4 page is filled.



The button **DELETE** deletes the entire log, and not simply the selected message(s).

The information held in the log is:

- the recipient of the fax,
- the date the fax was sent,
- the status (sent, rejected ...).

The inbox log

The inbox log is used to keep a history of all faxes received by your Terminal. The log is printed automatically as soon as an A4 page is filled.



The button **DELETE** deletes the entire log, and not simply the selected message(s).

The information held in the inbox log is:

- the sender of the fax,
- the date and reception of the fax,
- the status.

Fax parameters

Access to fax parameters

- 1 Click on the icon  of the window MF DIRECTOR.
- 2 Select **TOOLS > OPTION > FAX**.
- 3 Make the adjustments require, referring to the description of parameters below and click **OK**.

Description of the tab LOG AND REPORT

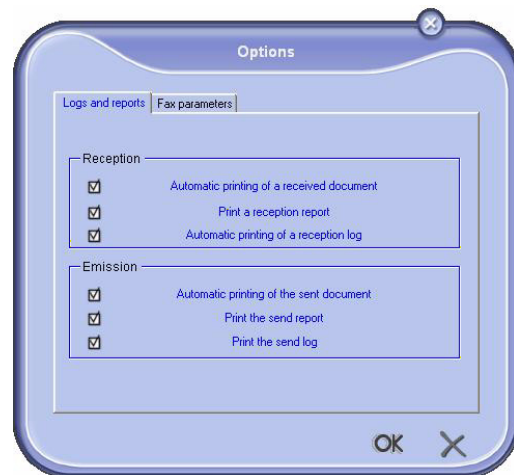

Field	Description
Automatic printing of a received document	The fax is automatically printed when received.
Printing of a inbox report	A report is printed out for each fax received.
Printing of inbox log	The log is automatically printed when it fills an A4 page.
Automatic printing of a sent document	The fax is automatically printed when it is sent.
Printing of an outbox report	An outbox report is printed after each fax is sent
Printing of the outbox log	The log is automatically printed when it fills an A4 page.

Description of the tab FAX PARAMETERS

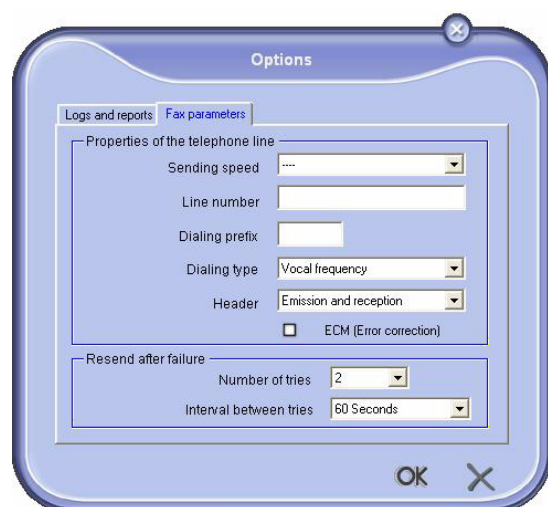

Field	Description
Transmission speed	Fax default transmission speed.
Line number	Number of the line where your terminal is connected.

Field	Description
Dialling prefix	This dialling prefix shall be automatically inserted in front of the number before sending on this line.
Type of dialing	Must be parametered according to the type of switchboard your terminal is connected to.
Header	Displays a Communication Identification Line (LIC) on the documents you send or on the documents you receive.
ECM	Corrects communication errors due to line disturbance. This option ensures that received documents are integral. On the other hand, communication times may be longer if the line is bad.
Number of attempts	Number of attempts the Terminal must make if send fails.
Interval between attempts	Duraton between two send attempts.

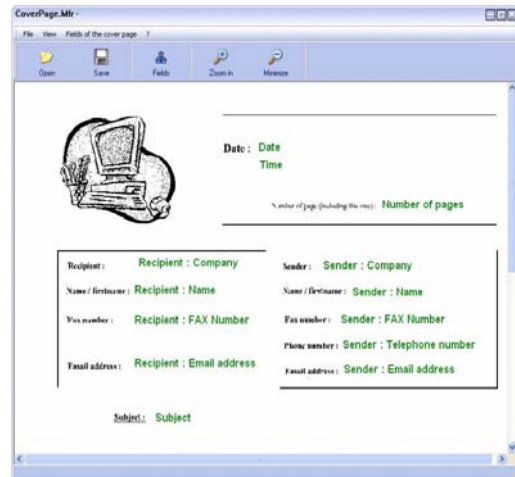

3 Click on the icon  to display the available fields.

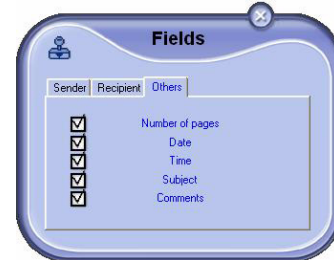
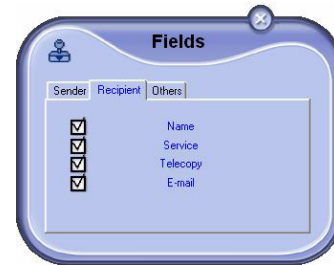
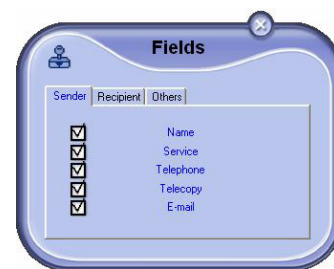

Cover sheet

The cover sheet is part of a fax document automatically generated by your terminal, on which there is information concerning the sender, the recipient, the date, the time sent, comments, etc...

This page may be sent alone or in front of a fax document, but always at the same time as the document. A document may be sent with a cover sheet from the multifunction terminal or from the central processing unit. In the latter case, some of the information in the cover sheet may be provided by yourself when making the send request. It is necessary to create model cover sheets before sending a document using them. On the other hand, once the cover sheet is created, a model cover sheet may be used for all documents sent.

Your terminal offers the possibility of creating and customizing some model cover sheets which you can choose when sending a fax.

Creating a cover sheet



It is necessary to create a model cover sheet before sending a fax with it.

- 1 From the tab COVER PAGE, click on the button NEW.
- 2 Select the model cover sheet you have created using the menu FILE.

A window with the model cover sheet you have created is displayed:



Adjust the size of your field so that the text is readable.

- 4 As soon as fields are inserted, save the cover sheet.

This cover sheet can be selected in the tab COVER PAGE of the fax send window.

Description of the tab COVER PAGE

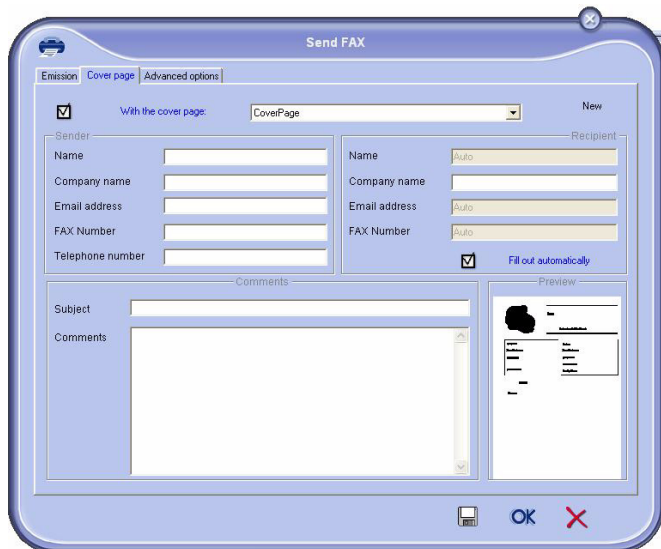

Field	Description
Name of the cover sheet	Either the name of the page selected by default or the page you have selected to use.
Sender	You can enter information concerning the sender.
Destination: Name, Company, Department	You can enter information concerning the recipient. If the word Auto is entered in one of the fields, the field is updated during sending if the recipient is listed in the directory, favorites, a group or a distribution list.
Comments	This is an editing window with all the basic functions of a text editor so that you can enter a text which will be sent in the cover sheet.
Preview of the model	The preview enables you to see the cover sheet you are going to send.

Creating a cover page template

Creating a cover page creates a template which fields (fax number, comment, subject and so on) will be automatically filled by the Fax Application depending on the information provided for each recipient of a document. To create this cover page template, there are two major steps:

- **First step** : Create a background image with the logos and the layout that you wish.
- **Second step** : Add the field that you want to be displayed in the cover page: fax number, comment, subject and so on. As mentioned before, these fields will be filled by Fax application at emission time.

For the first step, there are two methods to create the background image.

You can either

- Option (A): Draw this background image in your preferred application (such as Word, Excel,...),

OR

- Option (B): Scan a sheet of paper containing the layout of the cover page.

Details about Option A and B:

- Option (A): Open the application that you want to use to edit the background (Word, Wordpad...). Draw the background image then print this document in the printer named "Companion Suite Fax". At that point the MFSendFax dialog is displayed:

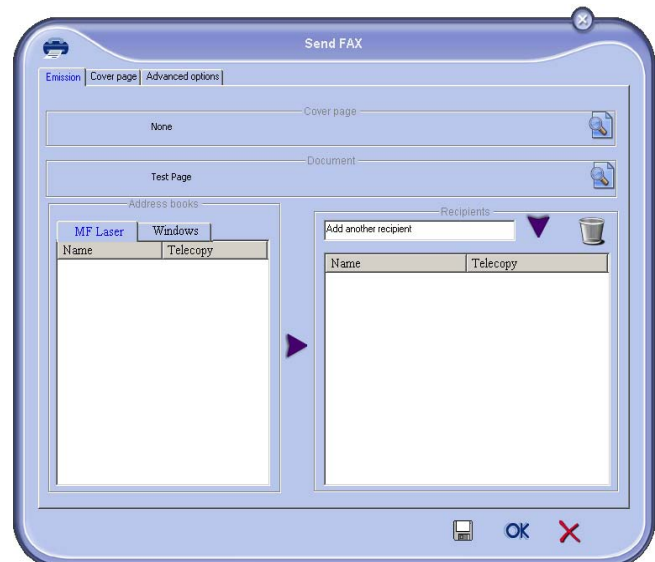

Add any recipient to the recipient list, click on the tab **ADVANCED OPTIONS**, select resolution **FINE** as shown below:

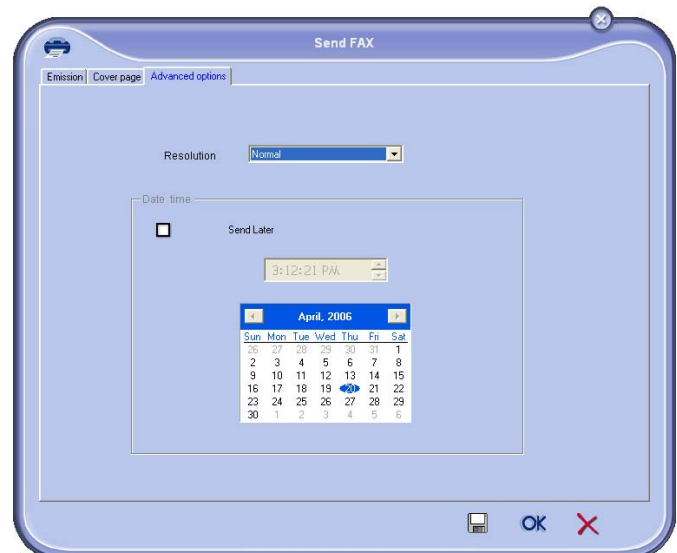

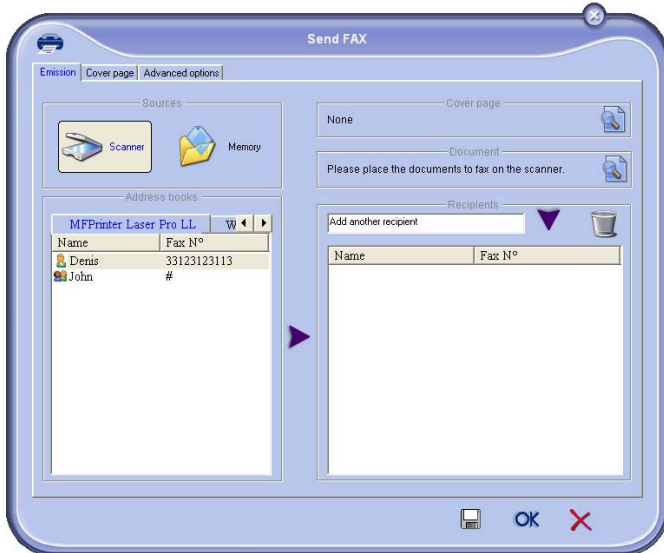

Finally click on the button **SAVE AS DRAFT** in the lower right corner (). The background image is created in the directory C:\Program Files\Companion Suite Pro LM\Documents\FAX\Temporary and has the file extension .fax

- Option (B): Launch **MFMANAGER**, select **NEW FAX**, select the scanner source as shown below :

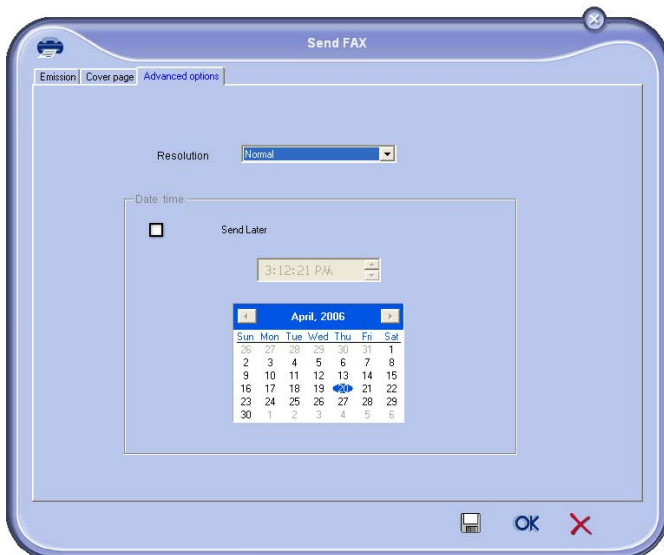

Add any recipient to the recipient list, click on the tab **ADVANCED OPTIONS**, select resolution **FINE** as shown below:



Finally click on the button **SAVE AS DRAFT** in the lower right corner (). The background image is created in the directory C:\Program Files\Companion Suite Pro LM\Documents\FAX\Temporary and has the file extension .fax.

Whether you choose Option **A** or **B**, you end up with a background image with extension .fax, which is located in C:\Program Files\Companion Suite Pro LM\Documents\FAX\Temporary.

➔ You can now proceed to the second step right below.

For the second step:

Now that the background image is created in directory in C:\Program Files\Companion Suite Pro LM\Documents\FAX\Temporary, you can add the fields on top of the background image.

Please follow the procedure below:

- Launch **MFMANAGER**, select **NEW FAX**, click on the tab **COVER PAGE**, and check the check box named **WITH THE COVER PAGE**.
- Click on the button **NEW**, this displays a new window with the title **CREATION OF THE COVER PAGE**.
- Press the button **OPEN** in the toolbar, change the file filter to *.fax and browse to the directory C:\Program Files\Companion Suite Pro LM\Documents\FAX\Temporary that contains the background image that you have created in the **First step**.
- Click on the button **FIELDS** in the toolbar, a window pops up allowing you to add the fields on top of the background image.
- Click on the button **SAVE** to save the Cover Page template and exit this window.
- The window **NEW FAX** is displayed, you can now choose the Cover Page template that you want to use. When you double click the preview image in the lower right corner, another window pops up giving you a preview of the cover page with the fields filled with the recipient's information.

SMS Communication

Sending SMSs is via the modem of your Multifunction Laser. For more details, refer to the User Manual of your Multifunction Laser.



The SMS service is available depending on the countries and the operators.

Your PC Kit can be used to easily send faxes to a single recipient or to multiple recipients using the distribution groups.

Communications being sent are monitored by means of the outbox, the outbox log and the outbox memory (items sent).

Presentation of the SMS window

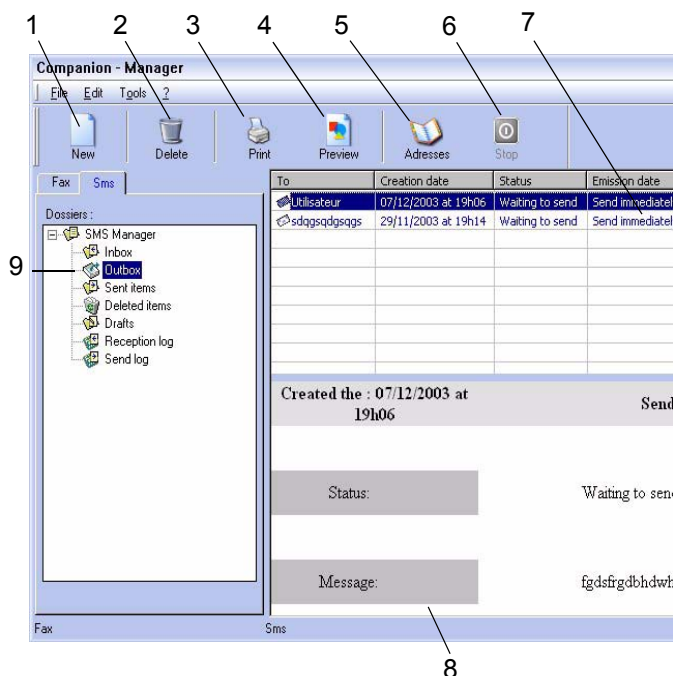

Item	Action
1	Write an SMS.
2	Delete an SMS from one of the SMS manager directories. Except for the directory SEND LOG for which the effect of this command is to delete the entire log.
3	Print an SMS from one of the SMS manager directories.
4	Display an SMS with the Viewer.
5	Access to the address book.
6	Stop SMS sending (only enabled for the outbox).
7	Displays all SMSs in the directory selected in the Fax manager.

Item	Action
8	SMS preview.
9	SMS manager directories.

Send an SMS

- 1 Click on the icon SMS  of the window MF DIRECTOR.
- 2 Click on **NEW** then on **SMS**.

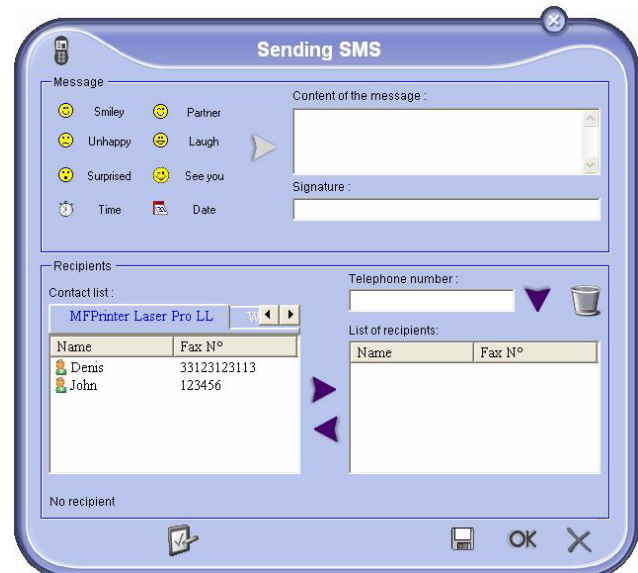

- 3 Enter your message in the field **CONTENT OF MESSAGE** provided for this purpose. You can use the **buttons** and the **"smiley"** located to the left of the input field to customize your message, or to automatically insert the date and time.
- 4 To send your SMS to a contact, enter his / her number in the field **TELEPHONE NUMBER** of the part **CONTACTS** and click on ▼ or select a recipient (or group) from one of the directories in the field **CONTACT LIST** and click on ►.

Repeat this operation as many times as necessary (use the button **REMOVE** to delete a contact from the list of contacts).

- 5 If necessary, adjust the advanced parameters (to send later or give priority to the SMS) by pressing the button **ADVANCED PARAMETERS**.



- 6 Click on **OK** to send your SMS to all contacts in the field **LIST OF RECIPIENTS**.

Your send request can then be checked, if necessary, in the outbox.

Follow-up of SMS

SMS communications are monitored by means of:

- an outbox,
- a sent item memory,
- an outbox log.

These services make it possible to have complete information on the terminal activity with regard to communications.

The outbox log is automatically printed when its contents fill an A4 page. After this automatic printing, the terminal creates a new log.

The outbox

The following is grouped in the SMS outbox:

- requests being sent,
- send later requests,
- requests for which one or more send attempts have already been made, and which will soon be redialed,
- requests which have been rejected.

The information in the sent box is:

- the SMS recipient,
- the date of sending of the SMS,
- the status (sent, rejected, etc...).

The sent item memory (items sent)

The sent item memory is used to keep a copy of all SMS messages you have sent.

The information in the sent item memory is:

- the SMS recipient,
- the date of creation of the SMS,
- the date of sending of the SMS,
- the size of the SMS.

SMS Parameters

Access to SMS parameters

- 1 Click the icon SMS  of the window **MF DIRECTOR**.
- 2 Select **TOOLS > OPTIONS > SMS**.
- 3 Make any adjustments required in relation to the description of the parameters above and validate with **OK**.

Description of the tab LOGS AND REPORTS

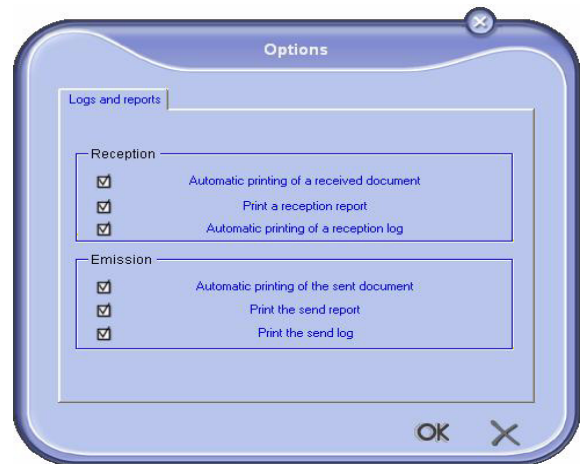
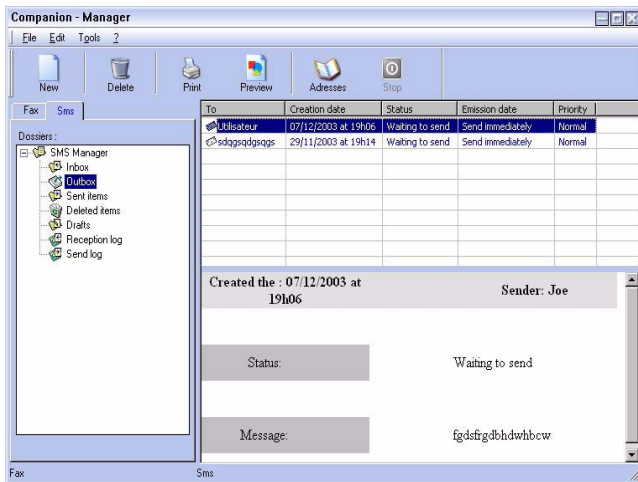

The outbox log

The outbox log is used to keep the entire history of SMS communications (successful or rejected) that have been processed by your terminal. The log is automatically printed as soon as an A4 page is complete.

Field	Description
Automatic printing of a sent document	The SMS is automatically printed when it is sent.
Printing of a send report	An outbox report is printed after each fax is sent.
Printing of the outbox log	The log is automatically printed when it fills an A4 page.



The button **DELETE** deletes the entire log and not simply the message(s) selected.

Maintenance

Service

General information



For your safety, it is imperative to refer to the security directives presented in the **Safety** booklet.

To ensure that your machine is kept in the best conditions, it is recommended that you periodically clean the inner parts.

Please respect the following rules while using this machine:

- Do not leave the scanner cover open.
- Do not try to lubricate the device.
- Do not close the scanner cover violently or do not apply vibrations to the machine.
- Do not open the cartridge access cover while printing.
- Do not try to disassemble the machine
- Do not use paper which would have stayed in the tray for too long.

Toner cartridge replacement

Your machine comes with a current consumable management system. It tells you if your toner cartridge is close to its end of cycle. The following message will appear on your machine screen.

**TONER NEAR
END**



After this message has been displayed, you are able to change the cartridge.

To quit this screen, press **OK**.

To replace the toner cartridge, proceed as shown below.

When the following message is displayed on the screen:

**TONER EMPTY
REPLACE <OK>**

- 1 Press **OK**.

**OPEN FRONT COVER
REPLACE TONER**

- 2 Stand in front of the device.
- 3 Push on the left and right sides of the cover and pull it towards you.
- 4 Raise and remove the toner cartridge from the machine.

- 5 Unpack the new cartridge and insert it into the slot as indicated in the diagram below.

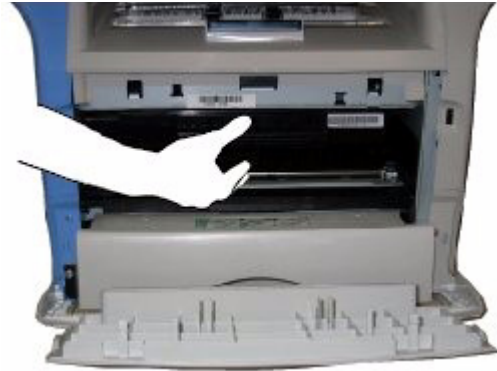

- 6 Close the cover.
The following message appears:

**HAVE YOU CHANGED
THE TONER? <OK>**

- 7 Press **OK**.
- 8 When this message appears,

**INSERT THE
TONER CARD**

insert the smart card provided with the new toner cartridge as shown on the picture below.



- 9 A wait message appears.

**PLEASE
WAIT**

The smart card is read.

**NEW TONER
REMOVE CARD**

Remove the smart card from the reader, your machine is ready to print again.

Issues with smart cards

If you use a smart card that has already been used, the machine will display:

**PLEASE
WAIT**

then,

**REMOVE CARD
ALREADY USED**

If you use a defective smart card, the machine will display:

**PLEASE
WAIT**

then,

**UNKNOWN CARD
REMOVE CARD**

If the **C** button is pressed while the smart card is being read, the machine displays:

**ACTION CANCELLED
REMOVE CARD**

Cleaning

Scanner reading system cleaning

When one or more vertical lines appear on the copies, clean the glass of the scanner.

- 1 Open the scanner cover until it is standing in vertical position.
- 2 Wipe the glass with a soft lint-free cloth soaked with mild alcohol.
- 3 Close the scanner cover.
- 4 Make a copy to check that the symptoms have disappeared.

Printer cleaning

Dust, dirtiness and paper debris on the external and internal surfaces of the printer can affect its operation. We advise that it is cleaned regularly.

Printer external cleaning

Clean the external part of the printer with a soft cloth soaked in mild detergent.

Printer issues

Error messages

When the printer encounters any of the problems described below, the corresponding message is shown on the machine display.

Message	Action
CHECK TONER	Check the presence of a toner cartridge in the machine.
TONER NEAR END	Indicates that your consumable will need changing soon.
REPLACE PAPER	Add paper in tray.
HEATING	Message displayed when starting the machine.

Message	Action
CLOSE COVER PRINTER	The printer front cover is open, close it.
TONER EMPTY REPLACE <OK>	Replace the toner cartridge.
PAPER JAM REMOVE TONER	A sheet of paper is jammed in the machine. Take out the toner cartridge and remove the jammed paper sheet. Take out the paper tray and remove the jammed paper sheet. Then open and close the consumable cover.
PAPER JAM EXTERNAL TRAY	A sheet of paper is jammed in the machine. Open the paper jam cover. Remove the jammed paper sheet. Then open and close the consumable cover.
PAPER EMPTY	Add paper in the paper tray.

Paper jam

When printing, a sheet of paper may get stuck in the printer or the paper tray and cause a paper jam.

In case of a paper jam in the machine, the following message appears:

**PAPER JAM
EXTERNAL TRAY**

- 1 Open the paper jam cover located at the back of the machine.
- 2 Remove the jammed sheet of paper and close the cover.

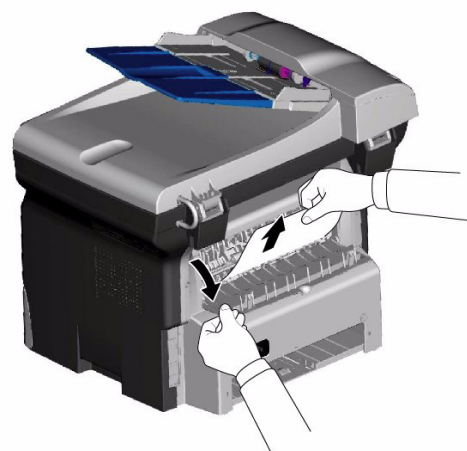

- 3 Open and close the consumable cover. The printer starts again automatically.



The fusion unit can reach a very high temperature during the operation. To prevent any harm, do not touch this area.

In case of paper jam, the following message appears:

**PAPER JAM
REMOVE TONER**

- 1 Remove the toner cartridge and check if a sheet is jammed.
- 2 Remove the sheet of paper which causes the paper jam.
- 3 Put the toner cartridge in the machine, or remove the paper tray and remove the sheet of paper which causes the paper jam.
- 4 Check that the paper sheets in the paper tray are correctly placed.



- 5 Replace the paper tray in the machine.

Scanner issues

When a paper jam occurs, the following message appears:

**REMOVE DOCUMENT
CONFIRM <STOP>**

- 1 Open the scanner cover.



- 2 Remove the jammed paper without tearing it.

The following message appears:

**CLOSE COVER
SCANNER**

- 3 Close the scanner cover.

Miscellaneous issues

When turning on the terminal, nothing is displayed on the screen.

Check the connection between the power cord and the outlet.

The terminal does not detect the presence of the document inserted in the scanner document feeder. The message READY does not appear on the screen. At the start and during scanning, REMOVE DOCUMENT appears on the screen.

- 1 Remove the document or press key .
- 2 Check the thickness of the document (50 sheets of paper of 80 g/m²).
- 3 Iron out the sheets if needed.
- 4 Help the sheets along.

The terminal does not receive any faxes.

- 1 Check that the telephone line cable is correctly plugged in.
- 2 Check that there is a tone signal on the telephone line by means of the key .

You receive a blank page.

- 1 Make a photocopy of a document; if it is correct then your fax is functioning normally.
- 2 Call back the subscriber and have him resend the document. It was probably sent with the sheet inserted backwards.

You cannot send a fax.

- 1 Check that the telephone line cable is correctly plugged in.
- 2 Check the tone by pressing the key .
- 3 Check the prefix is correctly programmed and used.

Communication errors

If the communication fails, the terminal advises you of an automatic retry later.



Example of what is displayed:

Current time
Time of next try

FRI 12 DEC 20:13
0142685014 20:18

Transmission from the feeder

You have the choice between:

- waiting until the transmission takes place at the given time,
- restarting the transmission immediately by pressing .
- abandoning transmission by pressing . To eject the document, press  again.

Transmission from memory

You have the choice between:

- waiting until the transmission takes place at the given time,
- restarting the transmission using the transmission queue. In this case, for a document composed of several pages, the transmission will take place from the page where the error occurred,
- abandoning the transmission by deleting the corresponding command in the transmission line.

The terminal makes at most 5 automatic redials. The non-transmitted document is automatically deleted from the memory and a transmission report is then printed together with an error code and the cause for transmission failure (see the communication error codes).

Communication error codes

The communication error codes appear in the logs and transmission reports.

General codes

Code 01 - Busy or no fax answer

This code appears after 6 unsatisfactory attempts. Call later.

Code 03 - User break

A communication has been stopped by the user pressing the key .

Code 04 - Non programmed number

A number saved as a one-touch key or abbreviated number is not valid, check it. (Example: a delayed transmission was programmed with a one-touch key and this key has been deleted in the meantime).

Code 05 - Scanning default

An incident occurred with the scanner, for example, the sheet is jammed.

Code 06 - Printer default

An incident occurred in the printer: no paper, paper jam, opened cover... In the reception mode, this incident appears only if the reception parameter is switched to **WITHOUT PAPER**.

Code 07 - Disconnected

The link has been cut (bad line). Check the number and try again.

Code 08 - Quality

The document you sent was not well received. Contact your subscriber to see if you need to send again.

Code 0A - No document to be polled

You tried to poll a document from a subscriber who had not prepared his document (no deposit) or the password entered was incorrect.

Code 0B - Wrong number of pages

There is a difference between the number of pages indicated during preparation for the transmission and the number of pages sent. Check the number of pages in the document.

Code 0C - Received document error

Ask the subscriber who called you to check the length of his document (it may be too long to be completely received).

Code 0D - Transmission failed

Ask the sender to resend the document.

Code 13 - Memory full

Your fax can no longer receive since its memory is full. There are too many received unprinted documents or too many documents in the transmission line. Print the received documents and delete or transmit immediately the documents in the transmission line.

Code 14 - Memory full

Received document memory full. Print all received documents.

Code 15 - Unknown mailbox number

You wish to deposit a document in a subscriber's mailbox. The mailbox number does not exist.

Code 16 - No Relay Bcst list Nr x

You requested a document relay from a remote fax but the fax has not programmed the list of subscribers requested.

Code 17 - Unknown mailbox number

You wish to recover a document from a subscriber's mailbox. The mailbox number does not exist.

Code 18 - Relay Bcst impossible

You requested a document relay from a remote fax which does not have the relay broadcast function.

Code 19 - Subscriber has stopped

The communication has been stopped by your subscriber. (Example: a fax wanted to poll your fax but there is no document deposited).

Code 1A - Disconnected

The transmission has not started. The telephone line is busy.

Code 1B - Transmission failed

During transmission: start again.

During reception: ask your subscriber to resend the document.

Code 50 - Server error

Check the number configured for the SMS server or a communication error occurred during data transmission.

Specifications

Physical specifications

Dimensions: 412 x 447 x 386 mm
Weight: 13 kg

Electrical specifications

Power supply: Single phase 220-240 V - 50/60 Hz - 4.5 A
Electric consumption: 12 W typical in powersave
16 W typical in standby
340 W average during printing

Environmental specifications

Operating temperature: In operation: + 10 °C to 32 °C
Acceptable humidity level: In operation: 15 % to 80 % HR (without condensation)

Peripheral specifications

Printer

Type: Laser (on normal paper)
Resolution: 600 dpi
Speed: 16 ppm maximum^a
Preheating time: 21 sec.
First page out time: 13 sec.

- a. Printing speed may vary depending on used operating systems, computer specifications, software applications, connection modes (LAN, USB or WLAN), paper formats as well as file types and sizes.

Copier

Type: Autonomous Black and White
Copy speed: 16 ppm maximum
Resolution: 600 dpi
Multiple copies: 99 pages maximum
Zoom range: 25 % to 400 %

Scanner

Type: Color scanner
Color depth: 36 bits
Resolution: 600 dpi (optical)
2400 dpi (interpolated)
Software compatibility: TWAIN
Maximum paper format: Letter

Printing supports

Main paper tray capacity: 250 sheets maximum (60 g/m²), 200 sheets maximum (80 g/m²)
Output tray capacity: 50 sheets
Main tray paper format: A4, A5, Legal, Letter
60 to 105 g/m² paper
Paper format for manual printing: A4, A5, Legal, Letter, B5, exec, A6
52 to 160 g/m² paper

PC connection

Slave USB 2.0 port (PC connection)
Master USB 2.0 port (Wlan connection, reader, USB memory key reader)
Operating System: Windows 98 SE, 2000SP3, ME, XP

Consumable specifications

Reference paper

Scanner : Inapa tecno SPEED A4.
Printer : Ricoh T6200 A4

Specifications are subject to changes for improvement without notice.

Oki Systems (UK) Limited

550 Dundee Road
Slough Trading Estate
Slough, SL1 4LE

Tel:44 (0) 1753 819819
Fax:44 (0) 1753 819899
<http://www.oki.co.uk>

Oki Systems Ireland Limited

The Square Industrial Complex
Tallaght, Dublin 24

Tel:+353 1 4049590
Fax:+353 1 4049591
<http://www.oki.ie>

Technical Support:

Tel:+353 1 4049570
Fax:+353 1 4049555
E-mail: tech.support@oki.ie

OKI Systems (Ireland) Ltd.

(Northern Ireland)
40 Sydenham Park
Belfast, BT4 1PW

Tel:+44 (0)28 90 20 1110
<http://www.oki.ie>

Technical Support:

Tel: +44 (0)28 90 221919
E-mail: tech.support@oki.ie

Oki Data Corporation

4-11-22 Shibaura, Minato-ku
Tokyo 108-8551

Tel:(81) 3 5445 6158
Fax:(81) 3 5445 6189
<http://www.okidata.co.jp>

Oki Data (Singapore) Pte. Ltd.

78 Shenton Way, #09-01,
Singapore 079120

Tel:(65) 221 3722
Fax:(65)421 1688
<http://www.okidata.com.sg>

Oki Systems (Thailand) Ltd.

956 Udomvidhya Building 6th Floor
Rama IV Rd.
Bangkok 10500

Tel:(662) 636 2535
Fax:(662) 636 2536
<http://www.okisysthai.com>

Oki Hong Kong Limited

Suite 1909, Tower3,
China Hong Kong City,
33 Canton Rd., Tsimshatsui,
Kowloon, Hong Kong

Tel:(852) 2736 0130
Fax:(852) 2376 3725

The IPL Group

63-85 Victoria Street
Beaconsfield NSW 2015, Australia

Tel:(61) 2 9690 8200
Fax:(61) 2 9690 8300
<http://www.oki.com.au>

Comworth Systems Ltd.

10 Constellation Drive Mairangi Bay,
Auckland,
New Zealand

Tel:(64) 9 477 0500
Fax:(64) 9 477 0549
<http://www.comworth.co.nz>

Oki Systems (Czech & Slovak), s.r.o.

IBC - Pobřežní 3
186 00 Praha 8
Czech Republic

Tel.: +420 224 890158
Website: www.oki.cz, www.oki.sk

OKI Printing Solutions (Denmark)

Herstedøstervej 27
2620 Albertslund

Adm.: +44 43 66 65 00
Hotline: +44 43 66 65 40
Salg: +44 43 66 65 30
Fax: +44 43 66 65 90
Website: www.oki.dk

Oki Systems (Deutschland) GmbH

Hansaallee 187
40549 Düsseldorf

Tel: +49 (0) 211 52 66 0
Fax: +49 (0) 211 59 33 45
Drucker Support:
+49 (0) 211 5262 501
Fax Support: +49 (0) 211 5262 502
Website: www.oki.de

Oki Systems (Iberica), S.A.

C/Teide, 3
San Sebastian de los Reyes
28700, Madrid

Tel: 91 3431620
Fax: 91-3431624
Atención al cliente: 902 36 00 36
Website: www.oki.es

Oki Systems (Finland) Oy

Kutomotie 18 B, 5. Krs
00380 Helsinki

Tel: +358 (0) 9 5404 420
Fax: +358 (0) 9 5404 4223
Website: www.oki.fi

Oki Systèmes (France) S.A.

44-50 Av. du Général de Gaulle
94246 L'Hay les Roses
Paris

Tel: 01 46 15 80 00
Télécopie: 01 46 15 80 60
Website: www.oki.fr

Oki Systems (Magyarország) Kft.

H1134 Budapest
Váci út 35

Telefon: +36 1 814-8000
Telefax: +36 1 814-8030
Webhely: www.okihu.hu

OKI Systems (Italia) S.p.A.

via Milano, 11
20084 Lacchiarella (MI)

Tel: 02.90026.1 (R.A.)
Fax: 02.90026.344
Website: www.oki.it

Oki Systems (Holland) b.v.

Neptunustraat 27-29
2132 JA Hoofddorp

Helpdesk: 0800 5667654
Tel: 023 5563740
Fax: 023 5563750
Website: www.oki.nl

Oki Systems (Belgium)

Schaarbeeklei 49 - 51
B-1800 Vilvoorde

Helpdesk: 02-2574620
Fax: 02 2531848
Website: www.oki.be

Oki Systems (Norway) A/S

Hvamsvingen 9
P.O.Box 174
N-2013 Skjetten

Tel: 63 89 36 00
Telefax: 63 89 36 01
Ordrefax: 63 89 36 02
Website: www.oki.no

Oki Systems (Polska) Sp. z o.o.

Leszno 14, 9th Floor
01-192 Warszawa

Tel.: +48 22 535 69 99
Fax: + 48 22 535 69 98
Website: www.oki.com.pl
E-mail: oki@oki.com.pl
Hotline: 0800 120066
E-mail: tech@oki.com.pl

**Oki Systems (Ibérica) S.A.
Sucursal Portugal**

Edifício Prime -
Av. Quinta Grande 53,7ºD
2614-521 Amadora

Tel: 21 470 42 00
Fax: 21 470 42 01
Website:
www.okiprintingsolutions.com.pt

**Oki Service
Serviço de apoio técnico ao Cliente**

Tel: 808 200 197
e-mail: okiserv@oki.pt

Oki Systems (Sweden) AB

Box 216
Drottningholmsvägen 320
161 26 Bromma

Tel. +46 8 634 37 00
e-mail: info@oki.se för allmänna frågor
om Oki produkter
support@oki.se för supportfrågor
rörandes Oki produkter
Vardagar: 08.30 - 12.00, 13.00 - 16.00
Website: www.oki.se

OKI Europe Ltd. (Russia)

B. Zlatoustinsky per. 1, bld. 6
Moscow 101000

Tel: +7 495 2586065
Fax: +7 495 2586070
e-mail: info@oki.ru
Website: www.oki.ru
Technical support:
Tel: +7 495 564 8421
e-mail: tech@oki.ru

OKI Europe Ltd. (Ukraine)

20, Velyka Zhytomyrska Street
"Panorama" Business Centre
5th Floor
Kiev 01025

Tel: +380 44 537-52-88
e-mail: info@oki.ua
Website: www.oki.ua

**Oki Sistem ve Yazıcı Çözümleri Tic. Ltd.
Şti.**

Harman Sokak
Harmancı Giz Plaza
Kat: 18 D: 35 34394 Levent
İstanbul

Tel : +90 212 279 2393
Fax : +90 212 279 2366
<http://www.oki.com.tr>
www.okiprintingsolutions.com.tr

CPI S.A. (Greece)

1 Rafailidou str
177 78 Tavros
Athens

Tel: +30 210 48 05 800
Fax : +30 210 48 05 801
e-mail: sales@cpi.gr
Website: www.cpi.gr

OKI EUROPE LIMITED

Central House

Balfour Road

Hounslow TW3 1HY

United Kingdom

Tel: +44 (0) 208 219 2190

Fax: +44 (0) 208 219 2199

WWW.OKIPRINTINGSOLUTIONS.COM

