

User's Manual

(November 2008)

TRADEMARKS

The *Bluetooth*[®] word mark and logos are registered trademarks owned by Bluetooth SIG, Inc.

The NVIDIA, NVIDIA logo, GeForce Boost, Hybrid Power and Hybrid SLI word mark and logos are registered trademarks owned by NVIDIA Corp. in the United States and other countries.

All brand and product names are trademarks or registered trademarks of their respective companies.

NOTE

The information in this manual is subject to change without notice.

Table of Contents

Preface	v
Notational Conventions.....	vi
Chapter 1 Getting Started	1-1
Getting the Computer Running	1-2
Unpacking	1-2
Connecting to AC Power	1-2
Opening the Cover	1-4
Turning On and Off the Computer	1-4
Taking a Look at the Computer.....	1-6
Right-Side Components	1-6
Left-Side Components	1-7
Bottom Components.....	1-8
Top-open Components	1-10
Where to Go from Here.....	1-13
Chapter 2 Operating Your Computer	2-1
Starting and Stopping the Computer	2-2
Starting the Computer	2-2
Stopping the Computer	2-2
Using the Multimedia Buttons	2-4
Using the Keyboard.....	2-7
Hot Keys	2-8
Using the Touchpad	2-11
Configuring the Touchpad	2-13
Using the DVD Drive.....	2-14
Inserting and Removing a Disc	2-14
Using the Video Features	2-16

	Configuring the Display Modes	2-16
	Using the Audio Features	2-17
	Connecting Audio Devices	2-18
	Using the Communication Features	2-21
	Using the LAN	2-21
	Using the Wireless LAN	2-21
	Using the <i>Bluetooth</i> [®] Wireless Feature (Optional)	2-24
Chapter 3	Managing Power	3-1
	AC Adapter	3-2
	Battery Pack	3-3
	Charging the Battery Pack	3-3
	Initializing the Battery Pack	3-4
	Checking the Battery Level	3-4
	Replacing the Battery Pack	3-5
	Battery Low Signals and Actions	3-7
	Power Management	3-9
	Hibernation	3-10
	Power-Saving Tips	3-11
Chapter 4	Expanding Your Computer	4-1
	Connecting an External Monitor	4-2
	Connecting a USB Device	4-7
	Connecting an eSATA Device	4-8
	Using ExpressCards	4-9
	ExpressCard Type	4-9
	Inserting and Removing an ExpressCard	4-10
	Using the Card Reader	4-12
	Internal Components Upgrade	4-14
Chapter 5	Using BIOS Setup	5-1
	When and How to Use BIOS Setup	5-2
	When to Use	5-2
	Starting BIOS Setup	5-2
	Moving Around and Making Selections	5-4

	Main Menu	5-5
	Advanced Menu	5-6
	Security Menu	5-8
	Boot Menu.....	5-9
	Exit Menu.....	5-10
Chapter 6	Installing Software Drivers.....	6-1
	How to Use the Driver Disc	6-2
	Install Driver	6-2
Chapter 7	Caring for the Computer	7-1
	Protecting the Computer.....	7-2
	Using the Windows Vista Security Center.....	7-2
	Using the Password	7-3
	Using the Cable Lock.....	7-4
	Taking Care of the Computer.....	7-5
	Location Guidelines	7-5
	General Guidelines.....	7-5
	Cleaning Guidelines	7-6
	Battery Pack Guidelines.....	7-6
	When Traveling.....	7-7
Chapter 8	Troubleshooting.....	8-1
	Preliminary Checklist.....	8-2
	Solving Common Problems.....	8-3
	Battery Problems.....	8-4
	Bluetooth Wireless Problems	8-4
	DVD Drive Problems	8-5
	Display Problems	8-5
	ExpressCard Problems	8-6
	Hardware Device Problems.....	8-7
	Hard Disk Drive Problems	8-7
	Keyboard, Mouse, and Touchpad Problems	8-8
	LAN Problems	8-8
	WLAN Problems.....	8-9

Power Management Problems.....	8-10
Software Problems	8-11
Sound Problems	8-11
Startup Problems	8-12
Other Problems.....	8-13
Resetting the Computer.....	8-14

Appendix A Specifications A-1

Appendix B Regulatory Information B-1

On the Use of the System.....	B-2
Class B Regulations	B-2
Safety Notices	B-3
On the Use of the RF Device.....	B-5
USA and Canada Safety Requirements and Notices.....	B-5
European Union CE Marking and Compliance Notices ..	B-8

Index I-1

Preface

This manual contains information that will help you operate the computer. It is divided into 8 chapters, 2 appendices, and an index.

- Chapter 1, **Getting Started**, takes you through the process of setting up the computer and identifying its external components.
- Chapter 2, **Operating Your Computer**, tells you how to use the computer's components and features.
- Chapter 3, **Managing Power**, provides information on power.
- Chapter 4, **Expanding Your Computer**, provides information on installing and using peripheral devices.
- Chapter 5, **Using BIOS Setup**, describes the BIOS Setup program that configures the computer's BIOS settings.
- Chapter 6, **Installing Software Drivers**, describes how to install the drivers and utilities supplied with the computer.
- Chapter 7, **Caring for the Computer**, gives you tips in care and maintenance.
- Chapter 8, **Troubleshooting**, gives solutions to common problems you may encounter when using the computer.
- Appendix A, **Specifications**, gives a brief specification of the computer.
- Appendix B, **Regulatory Information**, provides regulatory statements and safety notices on your computer.

Notational Conventions

Throughout this manual, the following conventions are used to distinguish elements of text.

| **NOTE:** identifies additional information that requires special attention.

| **CAUTION:** identifies important information that, if not followed, may result in loss of data or damage to the computer.

Keyboard keys are shown in a bold typeset. For example:

Press the **Enter** key to complete.

When keys are joined by a plus sign (+), press the first key, and, while keeping the first key down, press the remaining keys, finally release all the keys. When necessary, keys are also shown in graphics.

A title, command, setup item, or button that you can see on the screen is shown in boldface. A value or an option that you can select for a setup item is shown in italic. For example:

Select **When I press the power button**, set it to *Shut down*, and then click the **Save changes** button.

Getting Started

Congratulations on purchasing this multimedia-enhanced computer.

Your computer incorporates desktop computer and multimedia-enhanced capabilities into a notebook-sized package. It can greatly enhance your productivity either in the office or at home. And, of course, wherever you need it, the computer is ready and easy “to go.”

This chapter first tells you step by step how to get the computer up and running. You will find instructions for these procedures:

- Unpacking
- Connecting to AC power
- Opening the cover
- Turning on the computer
- Turning off the computer

Then, you will find a section briefly introducing the external components of the computer. And the last section navigates you to the information you may need after the computer is ready for use.

Getting the Computer Running

This section guides you through the procedures for getting the computer ready for operation.

Unpacking

After unpacking the shipping carton, you should find these standard items:

- Notebook computer
- Accessories:
 - AC adapter
 - AC power cord
 - Driver disc

Inspect all the items. If any item is damaged or missing, notify your dealer immediately.

Keep the shipping carton and packing materials in case you need to ship or store the computer in the future.

Connecting to AC Power

The computer operates either on the external AC power or internal battery power. It is suggested that you use AC power when you start up the computer for the very first time.

CAUTION: Use only the AC adapter included with your computer. Using other AC adapters may damage the computer.

1. Make sure that the computer is turned off.
2. Plug the DC cord of the AC adapter to the power connector of the computer (❶).

3. Plug the female end of the AC power cord to the AC adapter and the male end to an electrical outlet (2).

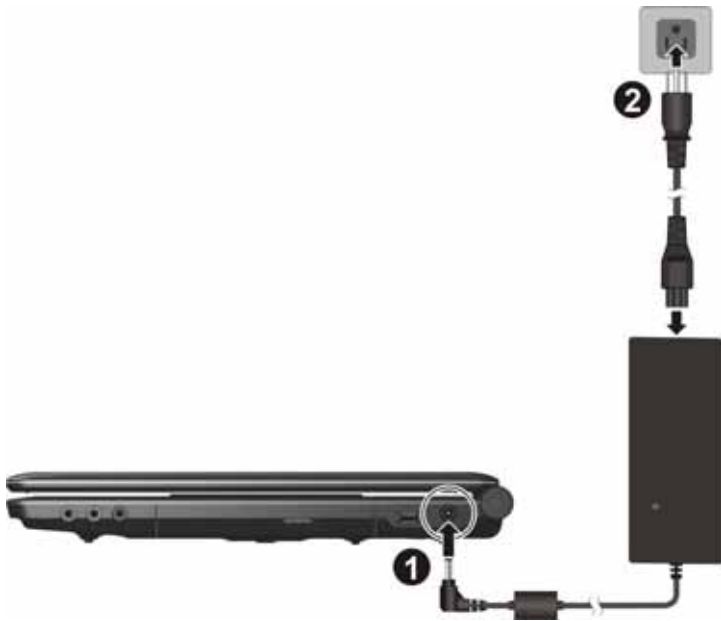

4. When the AC adapter is connected and turned on, power is being supplied from the electrical outlet to the AC adapter and onto your computer. Now, you are ready to turn on the computer.

CAUTION:

- When you disconnect the AC adapter, disconnect from the electrical outlet first and then from the computer. A reverse procedure may damage the AC adapter or the computer.
- When unplugging the connector, always hold the plug head. Never pull on the cord.

NOTE: When the AC adapter is connected, it also charges the battery pack. For information on using battery power, see Chapter 3.

Opening the Cover

CAUTION: Be gentle when opening and closing the cover. Opening it vigorously or slamming it shut could damage the computer.

Open the top cover by lifting up the cover. You can tilt the cover forward or backward for optimal viewing clarity.



Turning On and Off the Computer

Turning On

1. Make sure that the computer is connected to AC power.

2. Press the power button.



3. Each time the computer is turned on, it performs a Power-On Self Test (POST), and the operating system such as Windows should start.

Turning Off

To turn off the computer power, use the “Shut Down” command of your operating system.

NOTE: There are other ways you can stop the computer so that you will be back to where you left off when you next turn on the computer. (See “Stopping the Computer” in Chapter 2 for information.)

CAUTION: If you have to turn the computer on again immediately after turning it off, wait for at least five seconds. Turning the computer off and on rapidly can damage it.



Taking a Look at the Computer

This section identifies the external components of the computer and briefly describes the function of each component.

NOTE: Depending on the model you purchased, the appearance of your computer may not be exactly the same as those shown in this manual.

Right-Side Components



Ref	Component	Description	See Also
1	Headphone Connector 	Connects a set of headphones, external speakers with amplifier, or an audio recording device.	P. 2-18
2	Microphone-in Connector 	Connects an external microphone.	P. 2-18
3	S/PDIF Connector S/PDIF	Connects a S/PDIF device such as a digital speaker set for digital audio output.	P. 2-18
4	DVD Super Multi Drive	Accepts a DVD disc for installing or loading software, accessing data, and playing music/video.	P. 2-14
5	USB Port 	Connects a USB device, such as a flash disk, printer, digital camera, joystick, and more.	P. 4-7
6	Power Connector	Connects the AC adapter.	P. 1-2

Left-Side Components

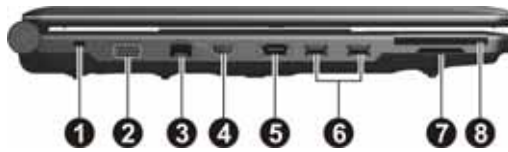

Ref	Component	Description	See Also
❶	Kensington Lock	Locks the computer to a stationery object for security.	P. 7-4
❷	VGA Connector	Connects an external display.	P. 4-2
❸	RJ-45 Connector	Connects the LAN cable.	P. 2-21
❹	HDMI Connector (hdmi)	Connects an external video device, such as a TV, supporting HDMI input. NOTE: Availability depends on your model.	P. 4-2
❺	eSATA/USB Combo Connector (eSATA)	Connects an eSATA device such as an external hard drive or optical drive. Can also connect a USB device, such as a flash disk, printer, digital camera, joystick, and more.	P. 4-8 4-7
❻	USB Ports ⇄	Each of the two ports connects a USB device, such as a flash disk, printer, digital camera, joystick, and more.	P. 4-7
❼	Card Reader	Accepts a MultiMediaCard (MMC), Secure Digital (SD), Memory Stick (MS) or Memory Stick PRO (MS PRO) card for removable storage media.	P. 4-12
❽	ExpressCard/54 Slot	Accepts an ExpressCard/34 or ExpressCard/54 for additional functions.	P. 4-8

Bottom Components

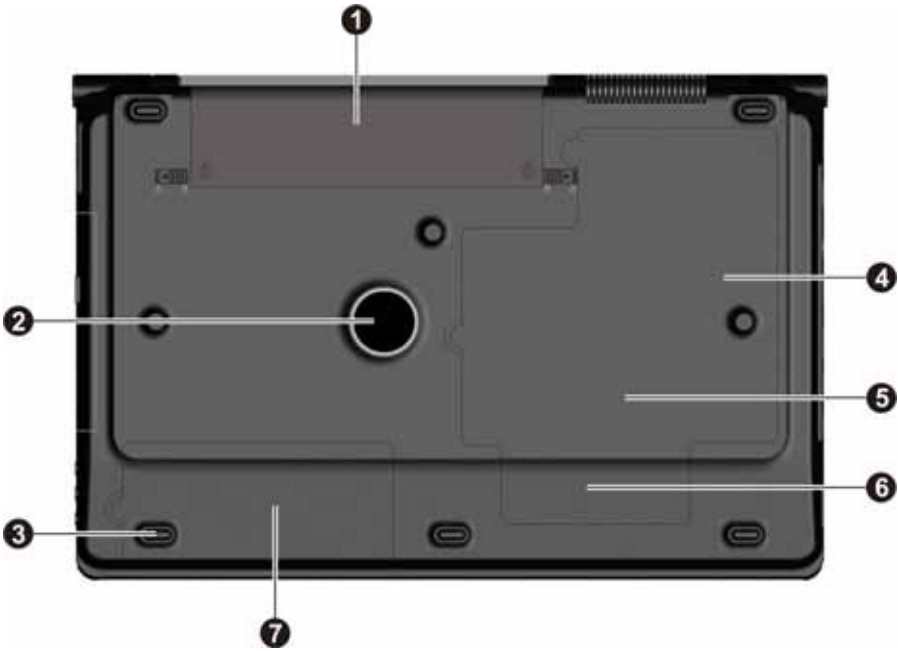













Ref	Component	Description	See Also
①	Battery Pack	Supplies power to your computer when external power is not connected.	P. 3-3
②	Subwoofer	Sends out the low frequency sound from the computer.	P. 2-17
③	Bluetooth Card Slot (option)	Inside is the slot for using an optional Bluetooth wireless card.	P. 2-21
④	CPU Socket	Inside is the CPU of your computer.	
⑤	Memory Slot	Inside are the memory slots for expanding the memory size of your computer.	
⑥	Wireless LAN (WLAN) Card Slot	Inside is the mini PCI-E slot for using a mini PCI-E WLAN card (standard or half-size).	P. 2-21

Ref	Component	Description	See Also
7	Hard Disk Drive Compartment	Inside is the hard disk drive.	

Top-open Components



Ref	Component	Description	See Also
❶	CMOS Camera Lens	Allows you to use your computer's camera function. NOTE: Availability depends on your model.	
❷	LCD Screen	Displays the output of the computer.	P. 2-16
❸	Stereo Speaker	Sends out sound and voice from the computer.	P. 2-17
❹	Power Button	Turns the computer power ON and OFF. Glows when the computer is turned on.	P. 1-4

Ref	Component	Description	See Also
5	Multimedia Buttons/ Indicators	Controls the computer's current multimedia status.	P. 2-4
		 Hybrid Boost button (option)	
		Press to cycle between Discrete GPU and motherboard GPU multimedia modes.	
		 Media button	
		Launches the Windows Media Center. When Media Center is open and performing a task, toggles between the two screens.	
		 Play/pause button	
		 Stop button	
 Next track button			
 Previous track button			
6	Microphone	Receives sound and voice for the computer.	P. 2-17
7	Keyboard	Serves as the data input device of the computer.	P. 2-4
8	Device Indicators	Show the current status of the computer's devices.	
		 Battery Charge indicator	P. 3-3
		Lights when the battery is being charged.	
		Blinks when battery power is low.	
		 Wireless LAN indicator	P. 2-22
		Glows when wireless LAN radio is on.	
		 <i>Bluetooth</i> [®] wireless indicator	P. 2-24
		Glows when <i>Bluetooth</i> [®] wireless radio is on.	
 Caps Lock indicator	P. 2-7		
 Num Lock indicator	P. 2-7		
 DVD drive / Hard disk drive in-use indicator	P. 2-14		

Ref	Component	Description	See Also
9	Touchpad	Serves as the pointing device of the computer.	P. 2-10

Where to Go from Here

As your computer is ready for operation, you may want to do any of the following now:

For this purpose...	Do this...
To know more about the computer...	Go on to the next chapter.
To install the operating system if your dealer has not already done so...	See the operating system manual.
To know more about the operating system...	Read the operating system manual.
To install the drivers if your dealer has not already done so...	See Chapter 6.
To set a power-on password...	See “Security Menu” in Chapter 5.
To charge the battery pack for the first time...	See “Charging the Battery Pack” in Chapter 3.

Operating Your Computer

This chapter provides information about the use of the computer.

If you are new to computers, reading this chapter will help you learn the operating basics. If you are already a computer user but are new to notebook computers, you may choose to read only the parts containing information unique to your computer.

Described in this chapter are the operating basics of these components:

- Keyboard
- Touchpad
- DVD drive

And these features:

- Starting and stopping the computer
- Multimedia features
- Video features
- Audio features
- Communication features

Starting and Stopping the Computer

There are a number of ways to start and stop the computer.

Starting the Computer

You always start the computer using the power button.

A computer starts up with an operating system (OS) existing on the storage device such as the hard disk and optical disc. The computer will automatically load the OS after you turn it on. This process is called booting.

NOTE: An operating system is the platform for all your software application programs to run on. Your computer uses the Microsoft Windows operating system.

Stopping the Computer

When you finish a working session, you can stop the computer by turning off the power or leaving the computer in Sleep or Hibernation mode:

To stop in this mode...	Do this...	To start up or resume again
Off	Follow the shutdown procedure of your operating system. This can prevent loss of unsaved data or damage to your software programs. If the system is locked up because of hardware or software problems, press the power button to turn off the computer.	Press the power button.
Sleep	Depending on your settings in Windows, you can place the computer in Sleep mode by: <ul style="list-style-type: none">• Closing the display cover• Pressing the Fn+F12 hot key• Pressing the power button	Press any key.

To stop in this mode...	Do this...	To start up or resume again
Hibernation	Depending on your settings in Windows, you can place the computer in Hibernation mode by: <ul style="list-style-type: none">• Closing the display cover• Pressing the power button	Press the power button.

If you choose to stop in Sleep or Hibernation mode, you can return to where you left off the next time you start up the computer. (See “Power Management” in Chapter 3 for more information.)

Using the Multimedia Buttons

Your computer features multimedia buttons.

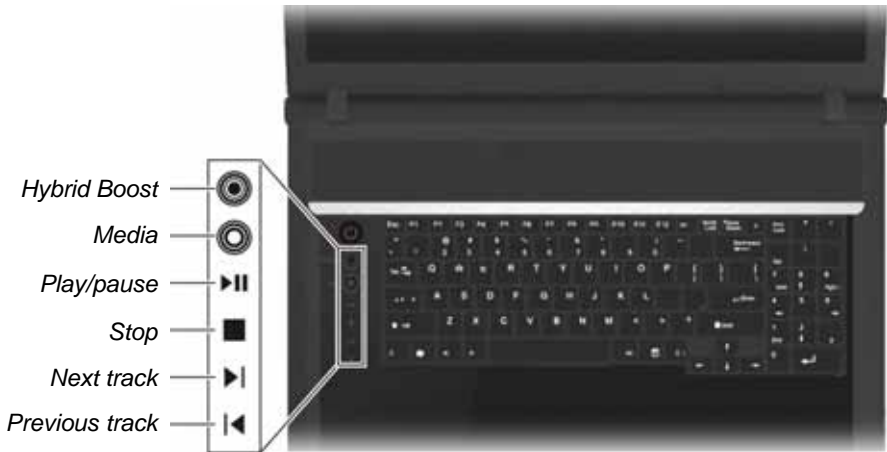



By default, your computer will adjust VGA performance based on your Windows Vista Power Plan and system power source, AC or battery power). You can press the optional Hybrid Boost button () to switch Discrete VGA on/off. When you restart computer the system will revert back to the default setting.

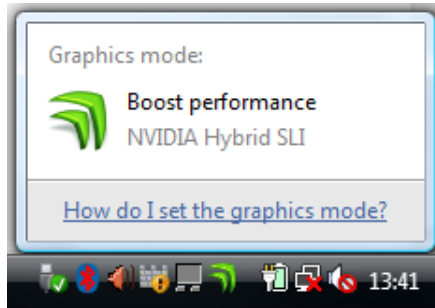

The next table shows the various factors affecting VGA performance. To learn more about using the video subsystem, right-click on the Hybrid SLI icon and click **How do I set the graphics mode?** to view the online Help.





Windows Vista Power Plan	Power Source	LED Behavior	Hybrid Boost State (Video)
Balanced	Battery power	OFF	Save power
Balanced	AC power (system active mode)	ON	Boost performance / GeForce boost
Balanced	AC power (system idle mode)	OFF	Save power
Power saver	Battery power	OFF	Save power
Power saver	AC power	OFF	Save power
High performance	Battery power	On	Boost performance / GeForce boost
High performance	AC power	On	Boost performance / GeForce boost

The Hybrid SLI icon appears in the Windows taskbar, indicating the graphics mode as follows:







Icon	Graphics Mode
	Boost performance mode
	Boost performance mode, but the Windows Vista Power Plan indicates Power saver.
	Save power mode

Icon	Graphics Mode
	Save power mode, but the Windows Vista Power Plan indicates High performance.
	Additional displays (not available on some systems).

You can also hover over or click the icon to view a pop-up window that tells you the current graphics mode.

1. Press the optional Hybrid Boost button () to cycle between Performance (Discrete GPU always turned on, LED is on) and Energy Saver (Discrete GPU is turned off but motherboard GPU is turned on, LED is off) multimedia modes.
2. Press the Media button () to launch Windows Media Center.

NOTE:

- When Windows Media Center is open, pressing the Media button () does not close Windows Media Center.
 - When Windows Media Center is running an application, pressing the Media button () toggles between both screens.
3. Press the play/pause button () to start the playback.
 4. You can use the previous track (), next track (), play/pause (), and stop () buttons for controls.

Using the Keyboard

The keyboard can be divided into four major areas plus an Fn key.

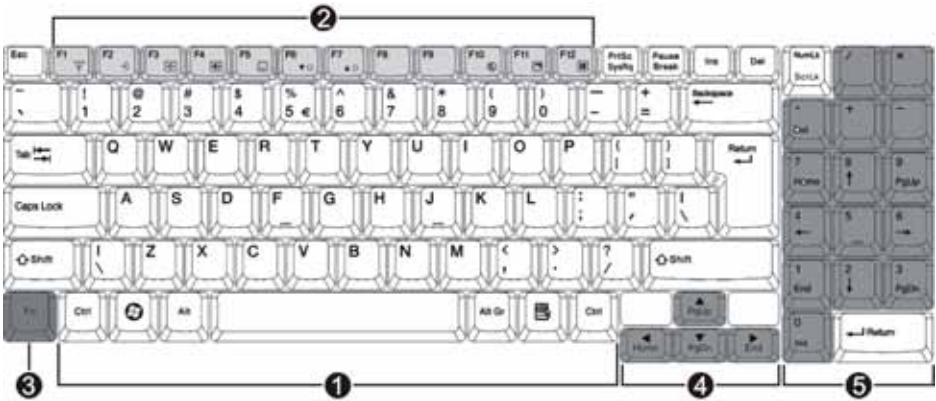









Ref	Component	Description
1	Typewriter Keys	Typewriter keys are similar to the keys on a typewriter. Several keys are added, such as the Ctrl, Alt, Esc and lock keys, for special purposes. When the lock keys are pressed, their corresponding indicators light up.
2	Function Keys	Function keys are multi-purpose keys that perform functions defined by individual programs.
3	Fn Key	The Fn key, at the lower left corner of the keyboard, is used with another key to perform the alternative function of a key. The letter “Fn” and the alternative functions are identified by the color of blue on the keytop. To perform a desired function, first press and hold Fn, then press the other key. Hot key functions are assigned to F1, F2, F3, F4, F5, F6, F7, F8, F10, F11, and F12 by your computer (see Hot Keys for details).
4	Cursor-Control Keys	Cursor-control keys are generally used for editing purposes. They are Home, End, Page Up, and Page Down. When used with Fn key, they become Left, Right, Up, and Down arrow keys.















Ref	Component	Description
5	Numeric Keypad	When Num Lock is on, the numeric keys are activated, which means you can use these keys to enter numerals. When Num Lock is off, they become cursor-control keys.

Hot Keys

Hot keys refer to a combination of keys that can be pressed any time to activate special functions of the computer. Most hot keys operate in a cyclic way. Each time a hot key combination is pressed, it shifts the corresponding function to the other or next choice.

You can easily identify the hot keys with the icons imprinted on the keypad. The hot keys are described next.

Key	Description
 	Switches the wireless LAN radio on and off.
 	Switches the Bluetooth wireless feature on and off.
 	Decreases the sound volume.
 	Increases the sound volume.

Key	Description
 	<p>Switches the display output to one of the following when external devices are connected.</p> <p>Upon booting the system with CRT:</p> <pre> graph LR LCD --> LCD_CRT[LCD+CRT] LCD_CRT --> CRT CRT --> LCD </pre> <p>Upon booting the system with HDMI:</p> <pre> graph LR LCD --> LCD_HDMI[LCD+HDMI] LCD_HDMI --> HDMI HDMI --> LCD </pre> <p>Upon booting the system with CRT and HDMI:</p> <pre> graph LR LCD --> LCD_CRT LCD_CRT --> CRT CRT --> LCD_HDMI LCD_HDMI --> HDMI HDMI --> LCD </pre> <p>NOTE: This function only applies to Plug & Play display devices.</p>
 	Decreases the LCD brightness (8 levels).
 	Increases the LCD brightness (8 levels).
 	Switches the multimedia buttons and indicators off and on.
 	Switches the system sound output off (mute) and on.
 	Switches the LCD panel on and off.
 	Serves as the sleep button that you can define with Windows' Power Options. (See the "Power Management" in Chapter 3.)



Euro Symbol

You can press the euro dollar sign € on various keyboards.

- To press the euro sign on a United States-International keyboard, hold down the **Alt Gr** key and press 5 (which has an euro sign on it).
- To press the euro sign on a standard United States keyboard, hold down either of the **Alt** keys and type **0128** on the numeric keypad part of your keyboard.
- To press the euro sign on an UK keyboard, hold down the **Alt Gr** key and press 4 (which has an euro sign on it).

Windows Keys

The keyboard has two keys that perform Windows-specific functions.

The  Windows Logo key opens the **Start** menu and performs software-specific functions when used in combination with other keys. The  Application key usually has the same effect as a right mouse click. (See your Windows manual for more information.)

Using the Touchpad

CAUTION: Do not use a sharp object such as a pen on the touchpad. Doing so may damage the touchpad surface.

NOTE: For optimal performance of the touchpad, keep your fingers and the pads clean and dry. When tapping on the pad, tap lightly. Do not use excessive force.

The touchpad is a pointing device that allows you to communicate with the computer by controlling the location of the pointer on the screen and making selection with the buttons.



The touchpad consists of a rectangular pad and a left and right buttons. To use the touchpad, place your forefinger or thumb on the pad. The rectangular pad acts like a miniature duplicate of your display. As you slide your fingertip across the pad, the pointer (also called cursor) on the screen moves accordingly. When your finger reaches the edge of the pad, simply relocate yourself by lifting the finger and placing it on the other side of the pad.

Here are some common terms that you should know when using the touchpad:

Term	Action
Point	Move your finger on the pad until the cursor points to the selection on the screen.
Click	Press and release the left button. –or– Tap gently anywhere on the pad.
Double-click	Press and release the left button twice in quick succession. –or– Tap twice on the pad rapidly.
Drag and drop	Press and hold the left button, then move your finger until you reach your destination (drag). Finally, release the button (drop) when you finish dragging your selection to the destination. The object will drop into the new location. –or– Gently tap twice on the pad and on the second tap, keep your finger in contact with the pad. Then, move your finger across the pad to drag the selected object to your destination. When you lift your finger from the pad, the selected object will drop into place.
Scroll	To scroll is to move up and down or left and right in the working area on the screen. To move vertically, place your finger on the right or left edge of the pad and slide your finger up and down along the edge. To move horizontally, place your finger on the top or bottom edge of the pad and slide your finger left and right. This function works only after you install the touchpad driver supplied with the computer and it may not work for all applications.

TABLE NOTE: If you swap the left and right buttons, “tapping” on the touchpad as an alternative method of pressing the left button will no longer be valid.

Configuring the Touchpad

You may want to configure the touchpad to suit your needs. For example, if you are a left-handed user, you can swap the two buttons so that you can use the right button as the left button and vice versa. You can also change the size of the on-screen pointer, the speed of the pointer, and so on.

To configure the touchpad, go to **Control Panel → Hardware and Sounds → Mouse Properties**. However, you can install the pointing device driver supplied with your computer to take advantage of more powerful features.

Using the DVD Drive

Your computer comes with a DVD drive, usually configured as drive D.

The **Super Multi drive** can work as a DVD-ROM drive for reading DVD (Digital Versatile Disc) discs in addition to CDs, audio CDs and CD-R/-RW discs, and CD-RW drive; can also write to DVD+R/+RW/-R/-RW and DVD-RAM discs.

CAUTION:

- When inserting a disc, do not use force.
- Make sure that the disc is correctly inserted into the tray, and then close the tray.
- Do not leave the DVD tray open. Also, avoid touching the lens in the tray with your hand. If the lens becomes dirty, the DVD drive may malfunction.
- Do not wipe the lens using materials with rough surface (such as paper towel). Instead, use a cotton swab to gently wipe the lens.

FDA regulations require the following statement for all laser-based devices:

"Caution, Use of controls or adjustments or performance of procedures other than those specified herein may result in hazardous radiation exposure."

NOTE: The DVD drive is classified as a Class 1 laser product. This label is located on the DVD drive.

**CLASS 1 LASER PRODUCT
LASER KLASSE 1**

NOTE: For DVD and Combo drives only.

This product incorporates copyright protection technology that is protected by method claims of certain U.S. patents and other intellectual property rights owned by Macrovision Corporation and other rights owners. Use of this copyright protection technology must be authorized by Macrovision Corporation, and is intended for home and other limited viewing uses only unless otherwise authorized by Macrovision Corporation. Reverse engineering or disassembly is prohibited.

Inserting and Removing a Disc

Follow this procedure to insert or remove a disc:

1. Turn on the computer.

2. Press the eject button and the DVD tray will slide out partially. Gently pull on it until it is fully extended.
3. To insert a disc, place down the disc in the tray with its label facing up. Slightly press the center of the disc until it clicks into place.

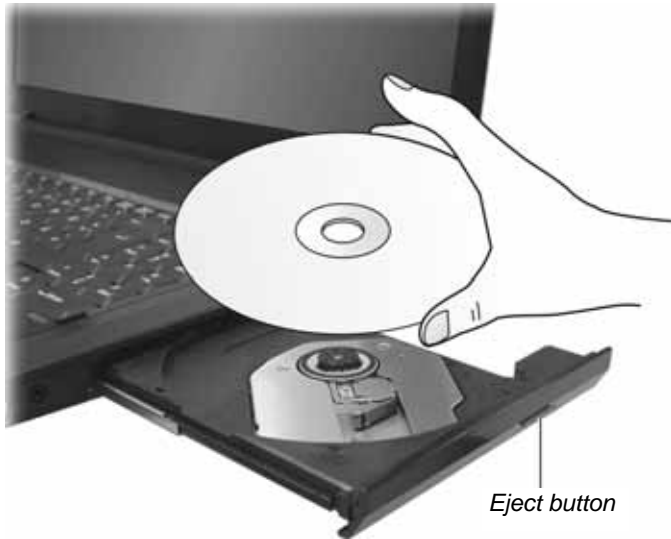

To remove a disc, hold the disc by its outer edge and lift it up from the tray.

4. Gently push the tray back into the drive.

NOTE: In the unlikely event that you are unable to release the DVD tray by pressing the eject button, you can manually release the disc. (See “DVD Drive Problems” in Chapter 8.)

Using the Video Features

The video subsystem of your computer features:

- 18.4-inch TFT (Thin-Film Transistor) color LCD display with 1680×945 pixel resolution (16:9)
- Simultaneous display on LCD and external display, which is useful when you have a presentation as you can control the screen from your computer and face the audience at the same time.
- Multi-display capability, which allows you to expand your desktop on the screen to another display device so that you have more desktop space to work on.
- Power Management

NOTE:

- Before using the multi-display capability or taking advantage of the enhanced video capabilities, the video driver supplied with your computer must be installed.
- The computer enters the Sleep or Hibernation mode when the LCD is closed. If you want to use the computer with the LCD closed, set *Do Nothing* to the “When I Close the lid” option in the **Power Options** → **System Settings** Properties. Thus the computer does not enter the Sleep or Hibernation mode when the LCD is closed.

Configuring the Display Modes

NOTE: When using an external CRT monitor, the resolution depends on the CRT monitor’s supported resolution.

Your computer has been set to a default resolution and number of colors before shipment. You can view and change display settings through your operating system. See your operating system documentation or online help for specific information.

For displaying in higher resolutions, you can connect an external monitor that supports higher resolutions. (See “Connecting an External Monitor” in Chapter 4 for more information.)

Using the Audio Features

NOTE:

- To take advantage of the enhanced audio capabilities, the audio driver supplied with your computer must be installed.
- If you experience interference while recording, try lowering the microphone recording volume.

The audio subsystem of your computer features:

- Built-in sound system for recording and playing sound on your computer
- Azalia interface (high density audio codec)
- Set of speakers (❶)
- Built-in microphone (❷)
- External audio connectors (❸), and
- Subwoofer on the bottom





Ways of playing and recording sound vary with the operating system used. See your operating system documentation or online help for specific information.

Connecting Audio Devices

For higher audio quality, you can send or receive sound through external audio devices.

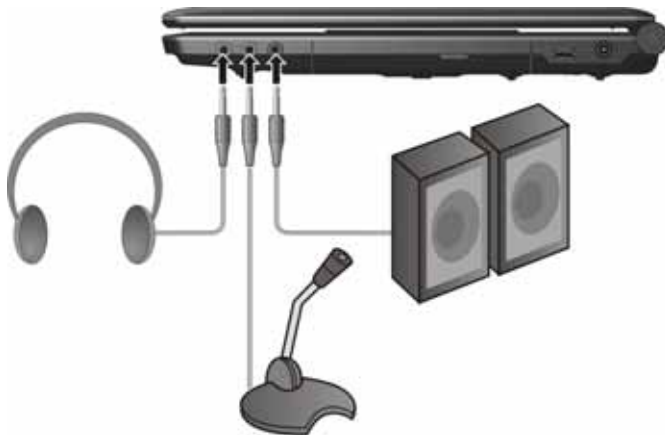
NOTE: After connecting an external audio device, make sure that you specify the use of the correct audio device in Windows.



- **Headphone Connector** () can be connected to speakers, headphones, or earphone set.
- **Microphone Connector** () can be connected to an external microphone for recording voice or sound.
- **S/PDIF Connector** (S/PDIF) can be connected to the line-in connector of S/PDIF (Sony/Philips Digital InterFace) compliant as well as ordinary powered speakers with built-in amplifiers, headphones, or earphone set. S/PDIF is a new audio transfer file format that ensures a high quality digital audio output through optical fibers.

NOTE:

- The S/PDIF connector is classified as a Class 1 laser product.
- When using the external speakers/headphones or microphone, you cannot use the internal one.



Connecting a 6-channel Speaker System

Your computer can connect a 5.1 6-channel speaker system for ultimate surround sound effect. You need to set the proper speaker configuration of the computer for your speaker system.

1. Double-click the **Sound Effect**  icon on the task bar.
2. Click the **Speakers** tab.
3. Select **5.1 Speaker** on the **Speaker Configuration** item.



4. Click OK.
5. Connect the speaker system to the computer properly.

Audio Connector	6-channel Mode Connection
Headphone connector ()	Connects to the front speakers
Microphone connector ()	Connects to the rear speakers
S/PDIF Connector (S/PDIF)	Connects to the center and subwoofer speakers

Using the Communication Features

Using the LAN

NOTE: To take advantage of the LAN feature, the Ethernet driver supplied with your computer must be installed.

The internal 10/100/1000Base-T LAN (Local Area Network) module allows you to connect your computer to a network. It supports data transfer rate up to 1000 Mbps.

To connect the network cable to the LAN module, connect one end of the LAN cable to the RJ-45 connector on the computer and the other end to the network hub.



Using the Wireless LAN

Depending on your model, an internal mini PCI-E wireless LAN (WLAN) card may have been pre-installed by your computer manufacturer at the factory. This card allows you to access corporate networks or the Internet in a wireless environment.

The WLAN features include:

- Peer-to-Peer (Ad-Hoc) and Access Point (Infrastructure) modes support
- WEP (Wired Equivalent Privacy) 64/128-bit data encryption
- IEEE 802.11b/g/n standard compliance

Technology	Stated Maximum Throughput (Mbps)	Data Rates (Mbps)	Band (GHz)	Modulation Technology
802.11b	11	11, 5.5, 2, 1	2.412 ~ 2.462	DSSS (Direct Sequence Spread Spectrum)
802.11g	54	54, 36, 18, 9	2.4	OFDM (Orthogonal Frequency Division Multiplexing)
802.11n	100 or more	100 ~ 210	2.4 / 5	Spatial multiplexing, uses MIMO (multiple-input multiple-output)

To take advantage of the WLAN feature, make sure that the wireless LAN driver is installed correctly. If your WLAN card was provided by your dealer instead of the computer manufacturer, contact your dealer for the correct driver to use.

Turning Off/On the WLAN Radio

NOTE: The FAA (Federal Aviation Agency) has deemed it unsafe to operate wireless devices in aircraft as this may interfere with flight safety. Remember to turn off wireless LAN when using your computer in the airplane.

Your computer has a built-in Fn+F1 WLAN hot key to switch the WLAN on/off (see “Hot Keys” in Chapter 2).

If you need to temporarily turn off the radio, press Fn+F1. To resume network connection, press Fn+F1 again.

It takes approximately 30 seconds for your computer to make a successful WLAN connection and approximately 10 seconds to disconnect.

Connecting to a Wireless Network

To connect to a wireless network:

1. Make sure that the WLAN radio is on (controlled by Fn+F1).
2. Right-click the **Wireless Network Connection** icon  located on the Windows system tray and select **Connect to a network**.

3. If any wireless network is detected, the following window appears on screen. Click the **Show** drop down menu and select **Wireless**.

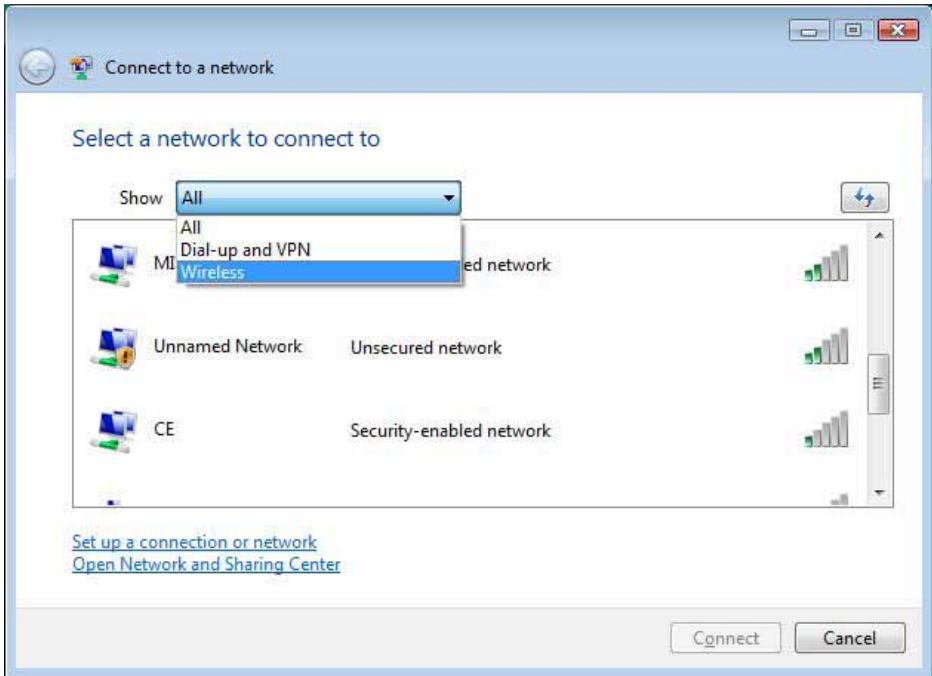

4. Select a wireless network to connect to by clicking a selection, then click **Connect**.
5. Depending on the settings, you may be asked to enter a WEP key (refer to your Windows online help for more information on setting a wireless network connection).

Using the *Bluetooth*[®] Wireless Feature (Optional)

| NOTE: Make sure that the Bluetooth driver is installed properly.

Depending on your model, your computer may incorporate the Bluetooth capability for short-range (about 10 meters – may be shorter due to physical barriers like walls, etc.) wireless communications between devices without requiring a cable connection.



With Bluetooth, data can be transmitted through walls, pockets and briefcases as long as two devices are within range.

Turning Off/On the *Bluetooth*[®] Wireless Feature

Your computer has a built-in Fn+F2 hot key to switch the *Bluetooth*[®] Wireless Feature on/off (see “Hot Keys” in Chapter 2).

If you need to temporarily turn off the *Bluetooth*[®] Wireless Feature, press Fn+F2. To resume wireless connection, press Fn+F2 again.



The status of the Bluetooth connection is indicated by the Bluetooth icon located in the system tray in the lower-right part of the screen.

Status	Icon
Off	 (blue with red logo)
On	 (blue with white logo).
Connected	 (blue with green logo)

You can use the Bluetooth Utility to configure Bluetooth connection settings and transfer files.

Connecting to Another Bluetooth Device

1. Make sure that the target Bluetooth device is turned on, discoverable and within close range. (See the documentation that came with the Bluetooth device.)

2. Double-click the  icon, then click on **New Connection** or click on **Bluetooth**, then **Add New Connection . . .**
Or right-click the  icon, and then click on **Add New Connection**.

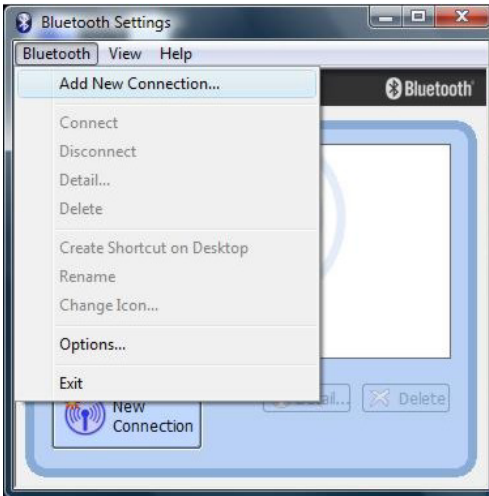

OR



3. The **Add New Connection Wizard** window appears. Select **Express Mode (Recommended)**, then click on **Next**.



4. Select the device to connect to and click on **Next**.



5. Depending on the type of Bluetooth device that you want to connect to, you will need to enter the pertinent information.

Sending a File

1. Right-click the  icon, and then click **Wireless File Transfer**.



2. The following screen appears.



3. In the **Wireless File Transfer** window, click **Add** to browse for the file to send. The file(s) will show on the **File/Folder** window.
4. Click the target device from the **Transfer-enabled device** window, and then click **Send** to start the transfer procedure.

For detailed information on using the Bluetooth Utility, see the Bluetooth Utility Help on your computer by clicking on **Help**, then **Help . . .**



Managing Power

Your computer operates either on external AC power or on internal battery power.

This chapter tells you how you can effectively manage power. To maintain optimal battery performance, it is important that you use the battery in the proper way.

The topics in this chapter include:

- What is an AC adapter
- How to charge the battery pack
- When and how to initialize the battery pack
- How to check the battery level
- How to replace the battery pack
- What happens when the battery is low and what actions to take
- What is Power Management
- How to save power

AC Adapter

CAUTION:

- The AC adapter is designed for use with your computer only. Connecting the AC adapter to another device can damage the adapter.
- The AC power cord supplied with your computer is for use in the country where you purchased your computer. If you plan to go overseas with the computer, consult your dealer for the appropriate power cord.
- When you disconnect the AC adapter, disconnect from the electrical outlet first and then from the computer. A reverse procedure may damage the AC adapter or computer.
- When unplugging the connector, always hold the plug head. Never pull on the cord.



The AC adapter serves as a converter from AC (Alternating Current) to DC (Direct Current) power because your computer runs on DC power, but an electrical outlet usually provides AC power. It also charges the battery pack when connected to AC power.

The adapter operates on any voltage in the range of 100~240 V AC.

Battery Pack

The battery pack is the internal power source for the computer. It is rechargeable using the AC adapter.

The operating time of a fully charged battery pack depends on how you are using the computer. When your applications often access peripherals, you will experience a shorter operating time.

NOTE: Care and maintenance information for the battery is provided in the “Battery Pack Guidelines” section in Chapter 7.

Charging the Battery Pack

NOTE:

- Charging will not start if the battery's temperature is below 0 °C (32 °F) or above 45 °C (113 °F).
- The charging process will stop and the Battery Charge Indicator flashes red when the battery's temperature gets above 60 °C (140 °F). If this happens, the battery pack may be damaged. Please contact your dealer.
- During charging, do not disconnect the AC adapter before the battery has been fully charged; otherwise you will get a prematurely charged battery.

To charge the battery pack, connect the AC adapter to the computer and an electrical outlet. The Battery Charge Indicator () on the computer glows to indicate that charging is in progress. You are advised to keep the computer power off while the battery is being charged. When the battery is fully charged, the Battery Charge Indicator is off.

The charging times are as follows:

Battery Type	Charging Time	
	Computer is Off	Computer is On and in Idle State
6-cell	2.5 hours	3 hours
9-cell	3.5 hours	5 hours

CAUTION: After the computer has been fully recharged, do not immediately disconnect and reconnect the AC adapter to charge it again. Doing so may damage the battery.

NOTE: The battery level may automatically lessen due to the self-discharge process (0.21 % per day), even when the battery pack is fully charged (100 %). This happens no matter if the battery pack is installed in the computer.

Initializing the Battery Pack



You need to initialize a new battery pack before using it for the first time or when the actual operating time of a battery pack is much less than expected.

Initializing is the process of fully charging, discharging, and then charging. It can take several hours.

1. Make sure that the computer power is turned off. Connect the AC adapter to fully charge the battery pack.
2. After the battery pack is fully charged, turn on the computer. When the message “**Press F2 to enter Setup**” appears, press the F2 key to display the BIOS Setup initial screen.
3. Disconnect the AC adapter and leave the computer on until the battery is fully discharged. The computer will shut down automatically.
4. Connect the AC adapter to fully charge the battery pack.

Checking the Battery Level

NOTE: Any battery level indication is an estimated result. The actual operating time can be different from the estimated time, depending on how you are using the computer.

You can check the approximate battery level using the battery meter function of the operating system. To read the battery level in Windows, click the  icon on the system tray. (Click the  icon if the computer is using AC power.)



Replacing the Battery Pack

CAUTION:

- There is danger of explosion if the battery is incorrectly replaced. Replace the battery only with the computer manufacturer's optional battery packs. Discard used batteries according to the dealer's instructions.
- Do not attempt to disassemble the battery pack.

If you often rely on battery power for a long period of time while traveling, you may consider the purchase of an additional battery pack from your dealer and keep it with you in a fully charged state as a backup.

To replace the battery pack, follow these steps:

1. Make sure that computer is not turned on or connected to AC power.
2. Place the computer upside down.
3. Slide the battery security lock outward to the unlock () position ().

- Slide the battery release lever outward to the unlock (🔓) position (❶) and, while holding it in the unlock position, remove the battery pack off the computer (❷).

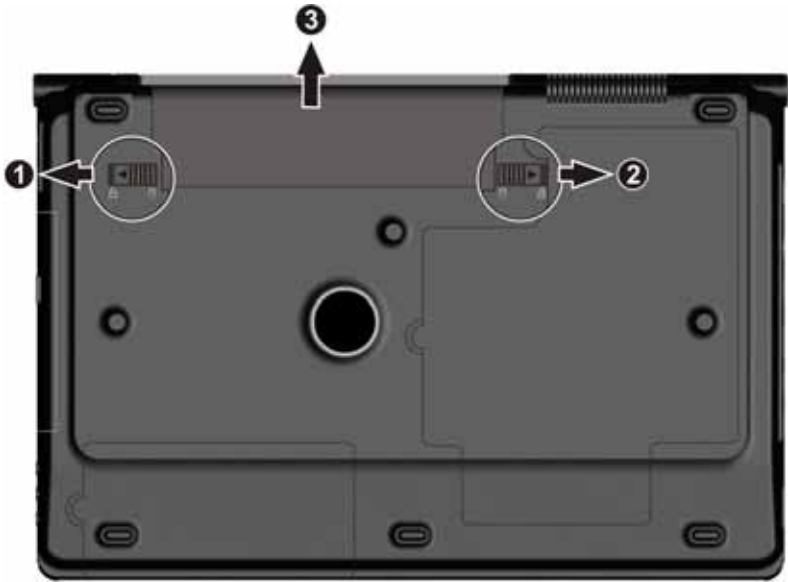

5. Fit another battery pack into place (❶) and slide the battery security lock to the lock (🔒) position (❷).

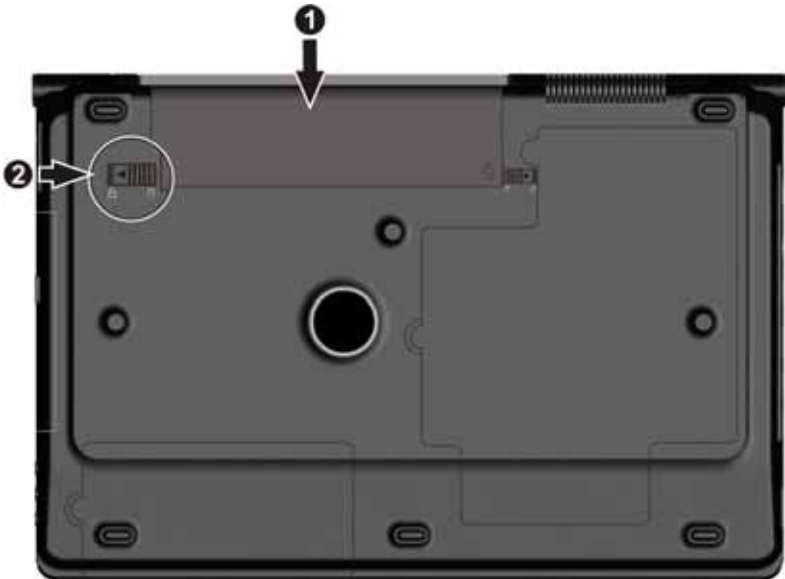

Battery Low Signals and Actions

The battery icon  changes appearance to display the current state of the battery so that you can see how much charge remains (Windows default setting). When the battery charge is above 25 % the battery icon is green. When the battery charge reaches 25 % a yellow triangle with an exclamation point (!) appears above the green battery icon. When the charge reaches the low battery level a red circle with a white “X” appears above the green icon.

The computer’s Battery Charge Indicator () blinks to alert you to take actions.

Immediately save your data upon Battery Low. The remaining operating time depends on how you are using the computer. If you are using the audio subsystem, ExpressCard, hard or USB flash disk, the battery might run out of charge very quickly.

Always respond to Battery Low by placing your computer on Hibernation mode, turning off the computer, or connecting the AC adapter.

CAUTION:

- If you are using an ExpressCard, do not access the card during battery low periods. This is because the access may take longer than the time it takes the battery to run out of charge, thus making your access to the card unsuccessful.
- If you fail to save your data when the battery completely runs out of charge, then you lose your data.

Power Management

Your computer supports ACPI (Advanced Configuration and Power Interface) for power management. The power management feature allows you to reduce the power consumption for energy saving.

With an ACPI-compliant operating system such as Windows, power supply to different computer components is controlled on an as-needed basis. This allows maximum power conservation and performance at the same time.

In general, Windows' power management works in this way:

What...	When...
Power to the hard disk is turned off	When the hard disk has been idle for a set period.
Power to the display is turned off	When the display has been idle for a set period.
The computer enters the Sleep mode. The hard disk and display are turned off and the entire system consumes less power.	When the entire system has been idle for a set period.
	When you press the Fn+F12 hot key. *
	When you close the cover. *
The computer enters the Hibernation mode. (See the next subsection for more information.)	When you press the power button. *
	When the entire system has been idle for a set period.
	When you press the Fn+F12 hot key. *
	When you close the cover. *
	When you press the power button. *

* Depends on your settings in Windows.

For detailed information on power management, see Windows' Help.

Hibernation

NOTE: Make sure that the hibernation feature is enabled in the “When I press the power button,” “When I press the sleep button,” and “When I close the lid” of the **Power Options** → **System Settings** Properties from the **Control Panel** → **Mobile PC**.

Hibernation is a very useful feature. People frequently open many applications when they use computers. It takes some time to get all these applications open and running, and normally they all have to be closed before the computer can be turned off.

When you use the hibernation feature, you do not have to close the applications. The computer stores the state of your computer to a file on the hard disk and then shuts down. The next time you turn on your computer, you return to exactly where you left off.

Power-Saving Tips

Aside from enabling your computer's power saving mode (see previous section), you can do your part to maximize the battery's operating time by following these suggestions.

- Do not disable Power Management. Choose a power plan that saves power when using Windows Vista. A power plan is a collection of hardware and system settings that control how your computer manages power.
- Decrease the LCD brightness to the lowest comfortable level.
- Shorten the length of time before Windows turn off the display.
- Many USB devices use power just by being connected. If you use a USB mouse, you can save power by disconnecting the mouse and using the touchpad. If you use a USB flash drive, unplug it when you are not using it.
- If you work with an application that uses an ExpressCard, exit the application when you finish using it.
- If you have an ExpressCard installed, remove it when not in use. Some ExpressCards drain power even while they are inactive.
- Deactivate the WLAN function if you are not using it. (See Chapter 2.)
- Deactivate the *Bluetooth* wireless function if you are not using it. (See Chapter 2.)
- Turn off the computer when you are not using it.

Expanding Your Computer

You can expand the capabilities of your computer by connecting other peripheral devices. When using a device, be sure to read the instructions accompanying the device together with the relevant section in this chapter.

This chapter gives guidelines on installing and using these devices:

- External monitor
- USB device
- eSATA device
- ExpressCard
- MMC/SD/MS/MS PRO card

Connecting an External Monitor

NOTE: Make sure that the video driver is installed correctly (see chapter 6 for details).

If you want the benefits of a larger display screen with higher resolution, you can connect an external CRT monitor or LCD monitor to your computer. Follow this procedure to connect an external monitor:

1. Make sure that the computer is not turned on.
2. Plug the monitor's signal connector to the computer's VGA / HDMI connector.

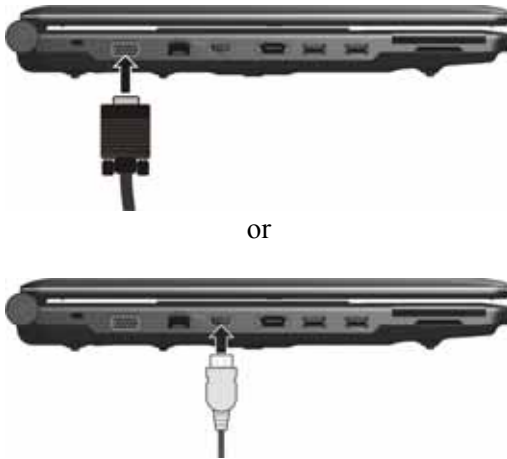

NOTE: Your computer allows you to only use either VGA or HDMI display one at a time, not simultaneously.

3. Plug one end of the monitor's power cord into the power socket on the monitor and the other end to an electrical outlet.
4. To use the monitor, turn on the monitor before turning on the computer.

5. The monitor should respond by default. If not, you can switch the display to the monitor or to both (simultaneous display), or to multi-display through the **Display Settings Properties** in Windows Vista (see your operating system documentation or online help for specific information).

CAUTION: Do not disconnect the external monitor while the computer is in the Sleep mode or Hibernation mode. If no external monitor is connected when the computer resumes, the LCD might not display properly.

Sound Output For HDMI Video

Normally, before you connect HDMI video, **Speakers** is the default setting.

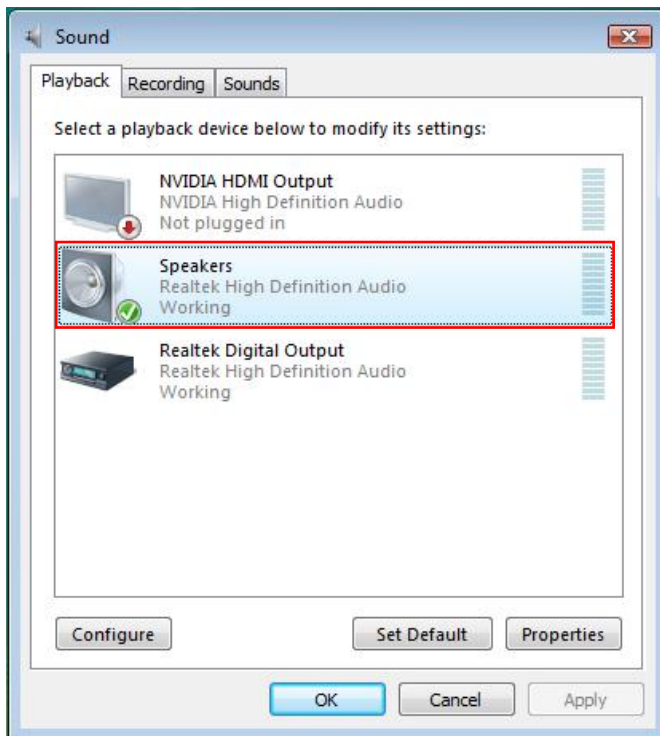

Upon connecting HDMI video, the setting may automatically be changed to **NVIDIA HDMI Output** to be able to have sound output.

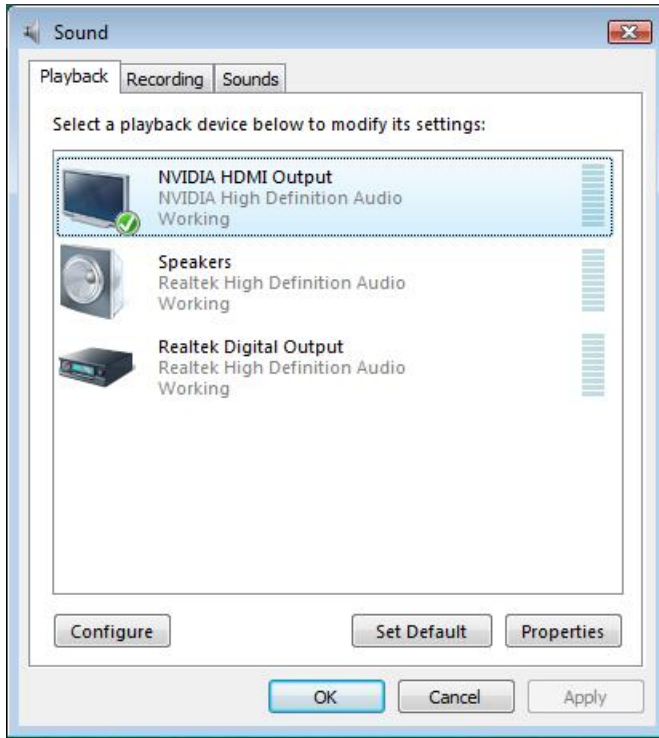

If in case there is no sound output upon connecting HDMI video, then you may need to perform the following:

1. Right-click the **Speaker** icon on the task bar and select **Playback**

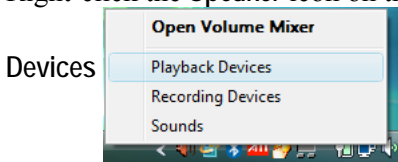

2. The following screen appears.

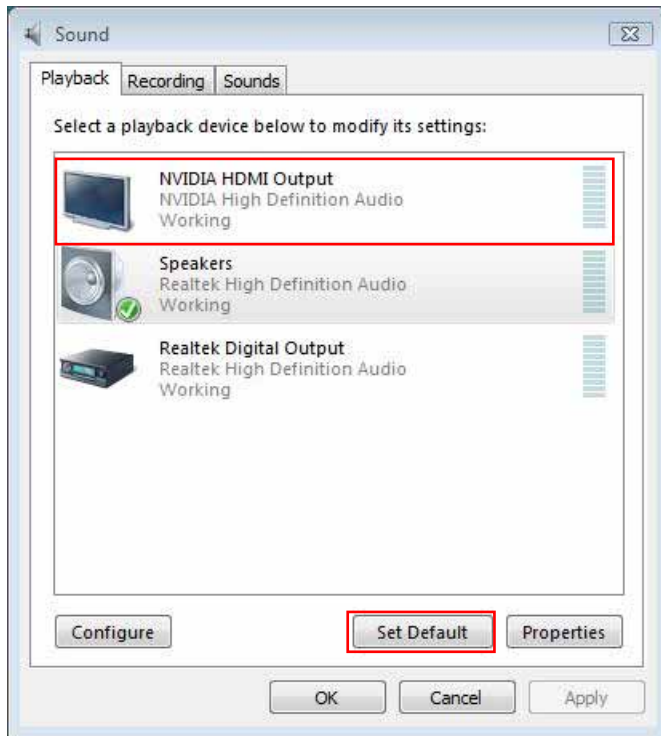

3. Click NVIDIA HDMI Output then click Set Default.

4. Notice that the checkmark (✓) appears on the item you have just selected.

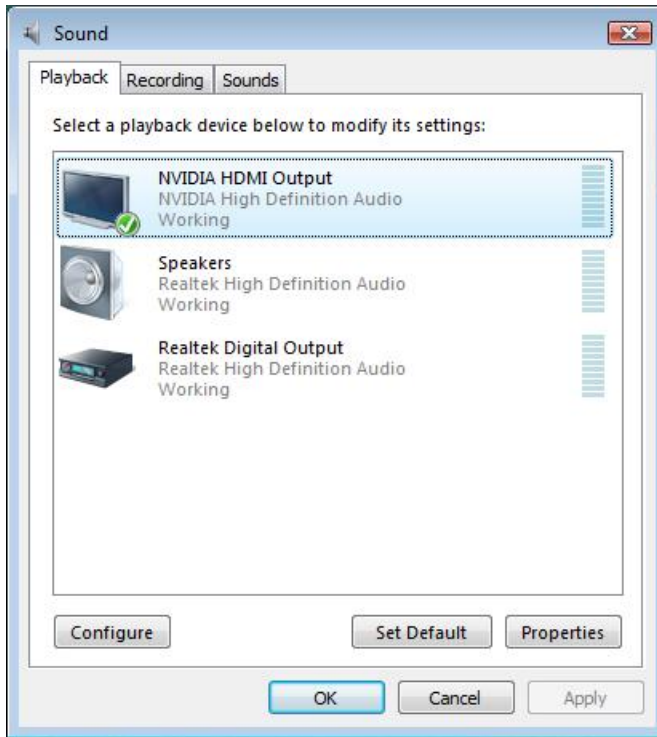

5. Click OK.

Connecting a USB Device

Your computer has three USB ports for connecting USB devices, such as a flash disk, digital camera, scanner, printer, modem, and mouse.

The USB ports support transfer rates up to 12 MB/s for USB 1.1 devices and 480 MB/s for USB 2.0 devices.

To connect a USB device, simply plug the device cable to one of the USB ports.

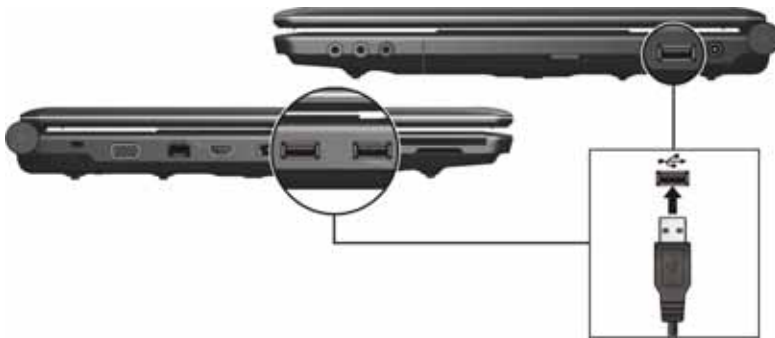

Connecting an eSATA Device

Your computer has an eSATA/USB Combo port for connecting eSATA devices (such as an external hard drive and external optical drive) / USB devices (see previous section).

The eSATA port supports transfer rates up to almost 120 MB/s.

To connect an external eSATA device, simply plug the device cable to the eSATA port.



Using ExpressCards

NOTE: The ExpressCard interface is not compatible with the PC card interface. You need optional adapters for using PC cards on your computer.

Your computer has an ExpressCard slot.

ExpressCard supports the PCI Express and USB 2.0 serial data interfaces (supporting speeds of up to 2.5 Gbps and 480 Mbps respectively), improving speed in data transfer while conserving power usage.

ExpressCard Type

The ExpressCard slot can accommodate a 54 mm (ExpressCard/54) or 34 mm (ExpressCard/34) wide ExpressCard. Typical ExpressCards support a very extensive range of applications including memory, wired and wireless communication cards, and security devices.

Shown next are the appearances of ExpressCards for your reference.

ExpressCard/54



ExpressCard/34



Inserting and Removing an ExpressCard

To insert an ExpressCard:

1. Locate the ExpressCard slot on the computer.
2. Press the cover tray (❶) and pull it out (❷).



3. Slide the ExpressCard, with its label facing up, all the way into the slot until the rear connectors click into place.



4. When a new card is seated, the computer will detect it and try to install the appropriate driver. Follow the on-screen instructions to complete the process.

To remove an ExpressCard:

1. Double-click on the **Safely Remove Hardware**  icon found on the Windows taskbar and the **Safely Remove Hardware** window appears on screen.
2. Select (highlight) the ExpressCard from the list to disable the card.
3. Push the ExpressCard slightly to release the card.
4. Pull the card out of the slot.



Using the Card Reader

NOTE:

- To take advantage of the Card Reader, the Card Reader driver supplied with your computer must be installed.
- If your hard disk is divided into several drives, make sure that all drives have been formatted before using the Card Reader. Otherwise, you may encounter problems when using the Card Reader.
- You can use only storage cards. Your Card Reader does not support cards with I/O (input/output) functions such as a wireless network card or Bluetooth card.

Your computer has a Card Reader. The Card Reader is a small drive for reading from and writing to removable storage cards (or called memory cards). The Card Reader supports the MultiMediaCard (MMC), Secure Digital (SD), Memory Stick (MS) and Memory Stick PRO (MS PRO) cards.

Shown next are the appearance and size of each card type for your reference.

Type	MMC Card	SD Card	MS/MS PRO Card
Appearance			
Size	24×32×1.4 (mm)	24×32×2.1 (mm)	21.5×50×2.8 (mm)

To insert a storage card:

1. Locate the Card Reader slot on the computer.
2. Align the card with its connector pointing to the slot and its label facing up. Slide the card into the slot until it reaches the end.



3. Windows will detect the card and assign it a drive name (typically E).

To remove a storage card:

1. Click Start, then Computer.
2. Right-click the drive with the card and select **Safely Remove**.
3. Pull the card out of the slot.

Internal Components Upgrade

You can upgrade your computer by changing the CPU and hard disk or adding memory. However, to avoid damage during the installation procedure, please ask your dealer for help. Do not install an internal component by yourself.

Using BIOS Setup

BIOS Setup Utility is a program for configuring the BIOS (Basic Input/Output System) settings of the computer.

BIOS is a layer of software, called firmware, that translates instructions from other layers of software into instructions that the computer hardware can understand. The BIOS settings are needed by your computer to identify the types of installed devices and establish special features.

This chapter tells you how to use the BIOS Setup program.

When and How to Use BIOS Setup

When to Use

You need to run BIOS Setup Utility when:

- You see an error message on the screen requesting you to run BIOS Setup Utility.
- You want to restore the factory default settings.
- You want to modify some specific settings according to the hardware.
- You want to modify some specific settings to optimize the system performance.

Starting BIOS Setup

NOTE:

- The BIOS Setup Utility screens shown in this chapter are for your reference only. The actual items or settings on your computer may differ.
- The BIOS Setup Utility program may have been updated after the publication of this manual.
- The settings you select in your operating system might override similar settings in BIOS Setup Utility.

To run BIOS Setup Utility, press the F2 key when the prompt appears on the screen during the system startup. The prompt shows up on the screen for only a few seconds. You must press the F2 key quickly. The BIOS Setup Utility main screen appears as shown next.

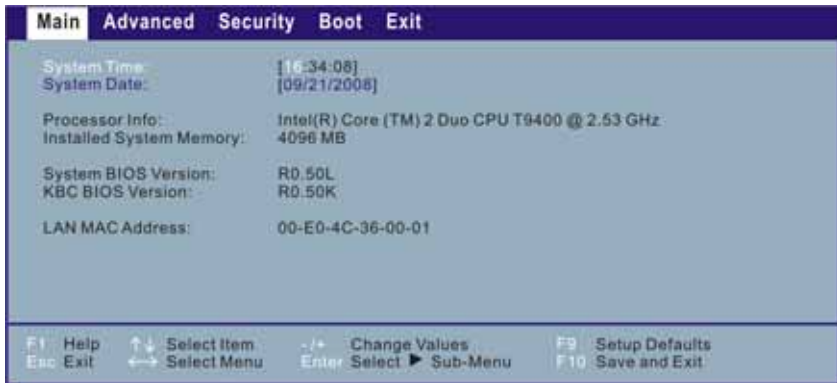

The BIOS Setup Utility screen can be divided into three areas:

- On the top is the menu bar containing the titles of the available menus. Each menu title brings a specific menu.
- The left column of the menu displays the menu items.
- The top-right of the menu provides more detailed information when a menu item is highlighted.
- The bottom of the menu provides keyboard instructions for moving around and making selections. When a menu item is highlighted.

Moving Around and Making Selections

You must go through two or three levels to complete the setting for an item. In most cases, there are three levels: menu title, pull-down menu, and submenu.

Use the keyboard to move around and make selections. Keyboard information can be found at the bottom of the screen. A brief description of keyboard usage is listed next:

Key	Function
← , →	Selects a menu title.
↑ , ↓	Selects an item or option.
Enter	1) Brings up the sub-menu when available. 2) Opens or closes the option window when an item is selected.
Esc	1) Exits BIOS Setup Utility. 2) Closes the option window if one is open.
F9	Loads setup defaults.
F10	Saves and exit the BIOS Setup Utility.

Main Menu

The Main menu contains the system date and time settings as well as shows the basic configuration of the system.



System Time sets the system time.

System Date sets the system date.

Advanced Menu

The Advanced menu contains various system settings.

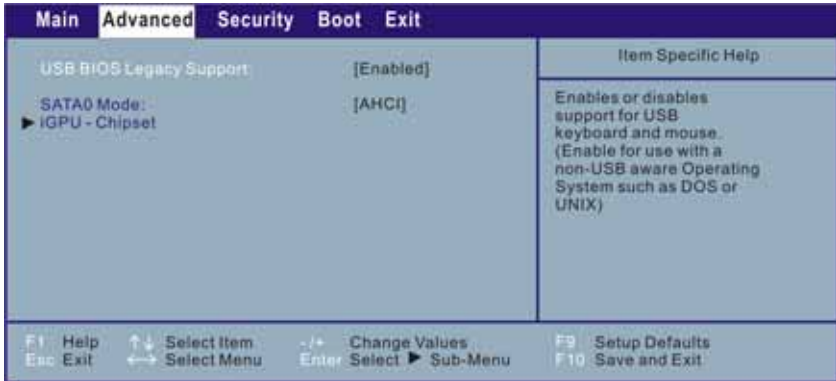

USB BIOS Legacy Support allows you to enable support for Legacy USB device in DOS mode.

SATA0 Mode allows you to select the mode of the serial ATA device.

iGPU – Chipset upon pressing Enter the following screen appears.

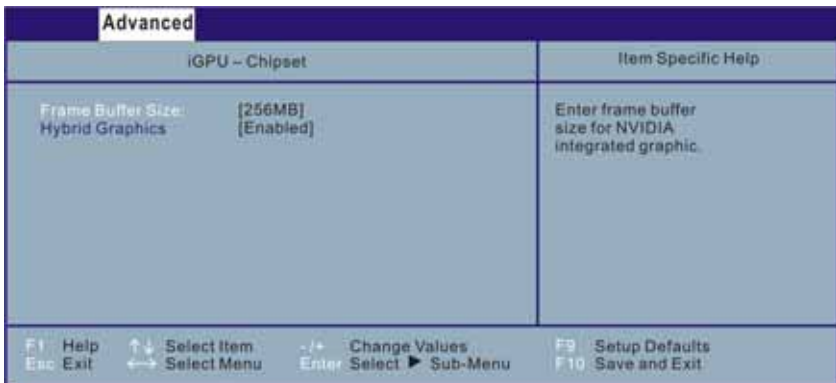

Frame Buffer Size allows you to select the NVIDIA® integrated graphic frame buffer size.

Hybrid Graphics allows you to enable the hybrid graphic feature.

Security Menu

The Security menu contains the security settings, which safeguard your system against unauthorized use.

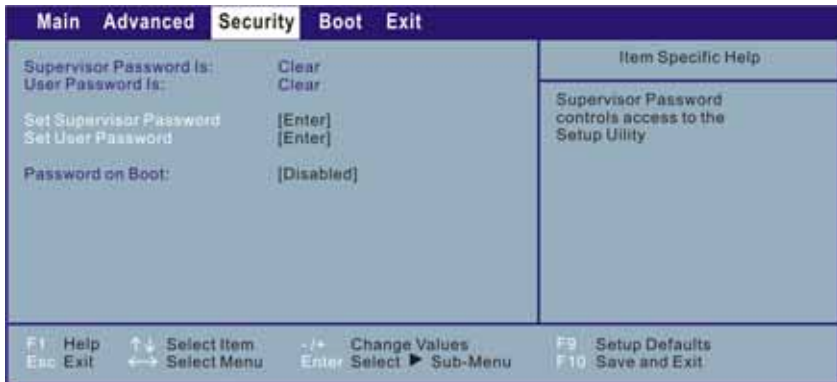

Supervisor/User Password Is shows whether you have set the supervisor/user password or not for the system.

Set Supervisor/User Password sets the supervisor/user password. When typing the password, first make sure that Num Lock is off, and then type the password in the entry fields and press Enter. Confirm your password by typing it again and pressing Enter. You can set the supervisor/user password to be required for starting up the system and/or entering SCU.

NOTE:

- You can set the user password only when the supervisor password has been set.
- If both the administrator and user passwords are set, you can enter any of them for starting up the system and/or entering SCU. However, the user password only allows you to view/change the settings of certain items.

Password on Boot allows you to enable or disable the entering of password for booting up your system. Once the password is successfully set and this item is enabled, it is required for booting up the system.

Boot Menu

The Boot menu sets the sequence of the devices to be searched for the operating system.



The bootable devices will be automatically detected during POST and shown here, allowing you to set the sequence that the BIOS use to look for a boot device from which to load the operating system. A brief description of keyboard usage is listed next:

Key	Function
↑, ↓	Selects (highlight) a boot device.
+, -	Changes the boot sequence.
1 to 4	Loads the four default boot sequence.
f, r	Specifies if the device is fixed or removable.
Shift + 1	Deactivates/activates the highlighted boot device on the “Boot priority order” list. When a device has been deactivated, an “!” (exclamation) symbol appears beside the item and system will bypass it when detecting boot device during POST.
X	Moves the highlighted boot device from the “Boot priority order” list to the “Excluded from boot order” list, and vice versa.

Exit Menu

The Exit menu displays ways of exiting BIOS Setup Utility. After finishing with your settings, you must save and exit so that the changes can take effect.

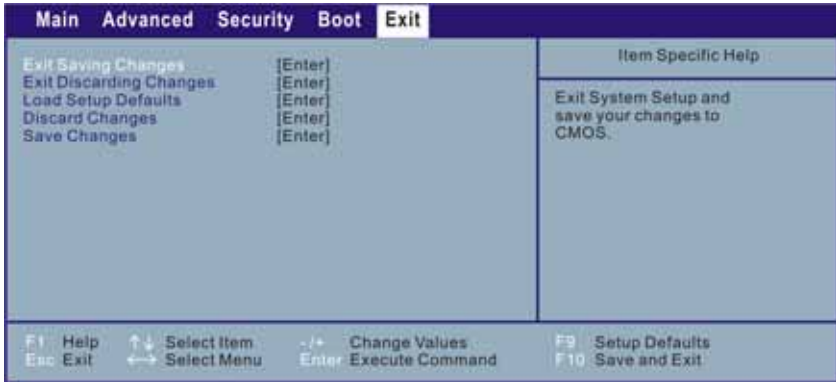

Exit Saving Changes saves the changes you have made and exits BIOS Setup Utility.

Exit Discarding Changes exits BIOS Setup Utility without saving the changes you have made.

Load Setup Defaults loads the factory default values for all the items.

Discard Changes restores the previous values for all the items.

Save Changes saves the changes you have made.

Installing Software Drivers

To take full advantage of the unique features of your computer, some operating systems require custom software, known as drivers, to be installed.

If you purchased the computer with Windows pre-installed, your dealer may have already installed the drivers. If not, you need to install the drivers using the disc supplied with your computer.

This chapter describes how to install the drivers.

How to Use the Driver Disc

NOTE:

- The drivers may have been updated after this manual was published. For driver upgrade, please contact your dealer.
- This disc supports Windows Vista.
- The available items may differ according to your computer model.
- Do not remove the driver disc when installing the driver.

An autorun program is provided on the driver disc to help you easily install the drivers. As you insert the disc, the autorun program automatically starts. If you need to start the program manually, run the **Setup.exe** program from the **Wsetup** directory of the disc.

The main screen appears as shown next:



Install Driver

To install the intended driver, click on the corresponding icon and installation will start. The drivers are described next:

Name	Description
Chipset driver	Ensures the full function of the following drivers. Install this driver before installing the other device drivers.
HDMI Audio driver	Installs the audio driver that allows you to take full advantage of the audio subsystem when connecting an external video device, such as a TV, supporting HDMI input.
VGA driver	Installs the video driver that allows you to select high-resolution displays with richer colors.
Audio driver	Installs the audio driver that allows you to take full advantage of the computer's audio subsystem.
Camera driver	Installs the PC camera driver that allows you to use the computer's built-in camera function.
Card Reader driver	Allows you to use the Card Reader to access optional MMC/SD/MS/MS PRO cards.
Touchpad driver	Installs the touchpad driver that allows you to take full advantage of the touchpad features.
WLAN driver	Installs the WLAN driver and application program that allows you to use the computer's internal mini PCI-E WLAN card's network function. NOTE: This icon would not appear if the mini PCI-E WLAN card is not installed.
Bluetooth driver	Installs the Bluetooth driver and application program that allows you to use the Bluetooth wireless feature.
Acrobat	Installs the Adobe Acrobat Reader program if you do not have it on your computer. You need Adobe Acrobat Reader to open the manual file supplied on this driver disc.
User's Manual	Allows you to view the User's Manual.
Exit	Allows you to exit driver installation (located on the right upper portion).

Caring for the Computer

Taking good care of your computer will ensure a trouble-free operation and reduce the risk of damage to your computer.

This chapter gives you guidelines covering these areas of maintenance:

- How to protect the computer
- What to note when using and storing the computer
- How to clean the computer
- What to note when using the battery pack
- What to note when traveling with the computer

Protecting the Computer

To safeguard the integrity of your computer data as well as the computer itself, you can protect the computer in several ways as described in this section.

Using the Windows Vista Security Center

Windows Security Center protects your computer against intrusion.

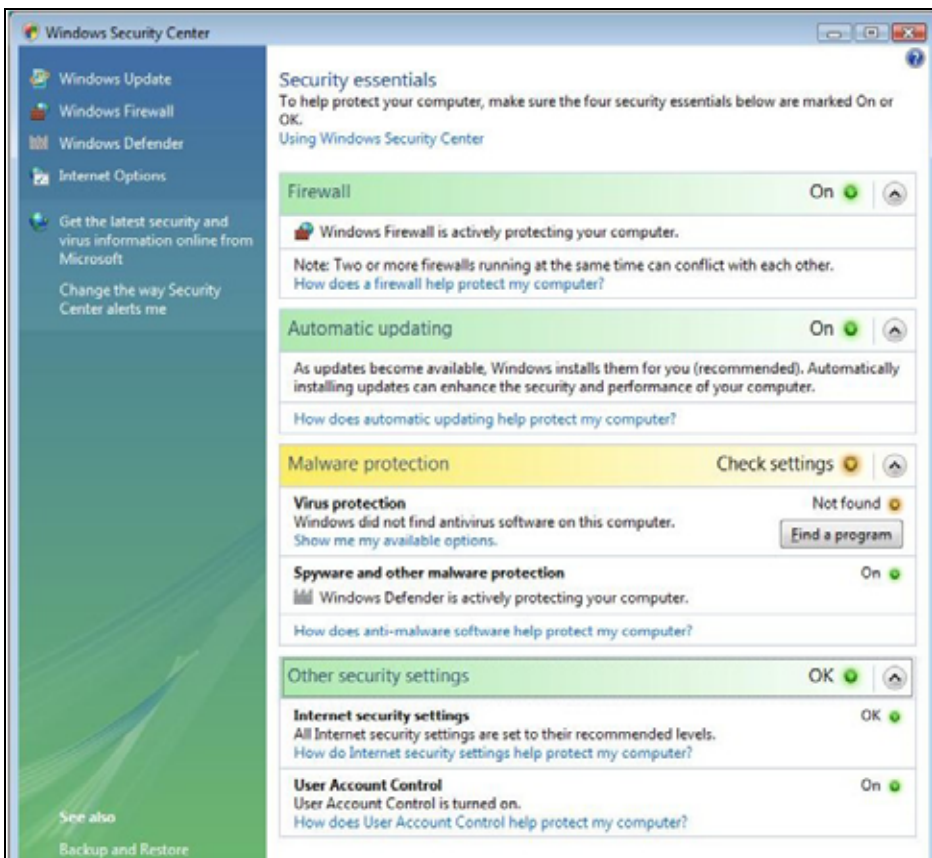

Windows Security Center alerts you to take action on the following security essentials:

- Windows Firewall
- Windows Update
- Malware Protection (anti-virus, anti-spyware)
- Others (Internet security, user account control)

For detailed information on Windows Security Center, see Windows' Vista Help.

Using the Password

The power-on password protects your computer against unauthorized use. If the password is set, the prompt requesting for the password appears on the screen whenever the computer is turned on.

The password is set via the BIOS Setup program. See "Security Menu" in Chapter 5 for instructions.

Using the Cable Lock

You can use a Kensington-type cable lock to protect your computer against theft. The cable lock is available in most computer stores.

To use the lock, loop the lock cable around a stationary object such as a table. Insert the lock to the Kensington lock hole and turn the key to secure the lock. Store the key in a safe place.



Taking Care of the Computer

Location Guidelines

- Use the computer where the temperature is between 10 °C (50 °F) and 35 °C (95 °F).
- Avoid placing the computer in a location subject to high humidity, extreme temperatures, mechanical vibration, direct sunlight, or heavy dust.
- Do not cover or block any ventilation openings on the computer. For example, do not place the computer on a bed, sofa, rug, or other similar surface. Otherwise, overheating may occur that results in damage to the computer.
- Keep the computer at least 13 cm (5 inches) away from electrical appliances that can generate a strong magnetic field such as a TV, refrigerator, motor, or a large audio speaker.
- Do not move the computer abruptly from a cold to a warm place. A temperature difference of more than 10 °C (18 °F) will cause condensation inside the unit, which may damage the storage media.
- Do not place the computer on an unsteady surface.

General Guidelines

- Wear protective gloves to prevent injury to your fingers when using the computer in higher than normal temperature.
- Do not place heavy objects on top of the computer when it is closed as this may damage the display.
- The screen surface is easily scratched. Do not use paper towels to clean the display. Avoid touching it with your fingers, pen, or pencil.
- To maximize the life of the backlight in the display, allow the backlight to automatically turn off as a result of power management.

Avoid using a screen saver or other software that prevents the power management from working.

Cleaning Guidelines

- Never clean the computer with its power on.
- Use a soft cloth moistened with water or a non-alkaline detergent to wipe the exterior of the computer.
- Gently wipe the display with a soft, lint-free cloth. Do not use alcohol or detergent on the display.
- Dust or grease on the touchpad can affect its sensitivity. Clean the pad by using adhesive tape to remove the dust and grease on its surface.

Battery Pack Guidelines

- Recharge the battery pack when it is nearly discharged. When recharging, make sure that the battery pack is fully charged. Doing so may avoid harm to the battery pack.
- Operate the computer with the battery pack installed even when using external power. This ensures that the battery is fully charged.
- If you will not be using the computer for a long period of time (more than two weeks), remove the battery pack from the computer.
- If you remove the battery pack, make sure that the battery terminals do not contact any conductors such as metal objects or water. Otherwise, the battery may become unusable as a result of a short circuit.
- If you need to store the battery pack, store it in a cool, dry place. Never allow the temperature to exceed 60 °C (140 °F).
- Do not leave the battery pack in storage for more than 6 months without recharging it.

When Traveling

- Before traveling with your computer, make a backup of your hard disk data into flash disks or other storage devices. As an added precaution, bring along an extra copy of your important data.
- Make sure that the battery pack is fully charged.
- Make sure that the computer is turned off and the top cover is securely closed.
- Do not leave objects in between the keyboard and closed display.
- Disconnect the AC adapter from the computer and take it with you. Use the AC adapter as the power source and as a battery-charger.
- Hand-carry the computer. Do not check it in as luggage.
- If you need to leave the computer in the car, put it in the trunk of the car to avoid exposing the computer to excessive heat.
- When going through airport security, it is recommended that you send the computer and flash disks through the X-ray machine (the device you set your bags on). Avoid the magnetic detector (the device you walk through) or the magnetic wand (the handheld device used by security personnel).
- If you plan to travel abroad with your computer, consult your dealer for the appropriate AC power cord for use in your country of destination.

Troubleshooting

Computer problems can be caused by hardware, software, or both. When you encounter any problem, it might be a typical problem that can easily be solved.

This chapter tells you what actions to take when solving common computer problems. It is divided into three sections:

- Preliminary checklist
- Solving common problems
- Resetting the computer

Preliminary Checklist

Here are helpful hints to follow before you take further actions when you encounter any problem:

- Try to isolate which part of the computer is causing the problem.
- Make sure that you turn on all peripheral devices before turning on the computer.
- If an external device has a problem, make sure that the cable connections are correct and secure.
- Make sure that the configuration information is properly set in the BIOS Setup program.
- Make sure that all the device drivers are correctly installed.
- Make notes of your observations. Are there any messages on the screen? Do any indicators light? Do you hear any beeps? Detailed descriptions are useful to the service personnel when you need to consult one for assistance.

If any problem persists after you follow the instructions in this chapter, contact an authorized dealer for help.

Solving Common Problems

For easy reference, the problems are divided into these categories.

Problem Type	Go to
Battery Problems	P. 8-4
Bluetooth Problems	P. 8-4
DVD Drive Problems	P. 8-4
Display Problems	P. 8-5
ExpressCard Problems	P. 8-6
Hardware Device Problems	P. 8-6
Hard Disk Drive Problems	P. 8-7
Keyboard, Mouse, and Touchpad Problems	P. 8-8
LAN Problems	P. 8-8
WLAN Problems	P. 8-9
Power Management Problems	P. 8-10
Software Problems	P. 8-11
Sound Problems	P. 8-11
Startup Problems	P. 8-12
Other Problems	P. 8-13

Battery Problems

The battery does not charge (Battery Charge indicator does not light).

- Make sure that the AC adapter is properly connected.
- Make sure that the battery is not too hot or cold. Allow time for the battery pack to return to room temperature.
- Make sure that the battery pack is installed correctly.
- Make sure that the battery terminals are clean.

The operating time of a fully charged battery becomes shorter.

- If you often partially recharge and discharge, the battery might not be charged to its full potential. Initialize the battery to solve the problem. (See “Initializing the Battery Pack” in Chapter 3 for instructions.)

The battery operating time indicated by the battery meter does not match the actual operating time.

- The actual operating time can be different from the estimated time, depending on how you are using the computer. If the actual operating time is much less than the estimated time, initialize the battery. (See “Initializing the Battery Pack” in Chapter 3 for instructions.)

Bluetooth Wireless Problems

I cannot connect to another Bluetooth-enabled device.

- Make sure that the Bluetooth card is correctly installed.
- Make sure that the Bluetooth driver is correctly installed.
- Make sure that both devices have activated Bluetooth.
- Make sure that the distance between the two devices are not over 10 meters or that there are no walls or other obstructions between the devices.
- Make sure that the other device is not in “Hidden” mode.

- Make sure that both devices are compatible.

DVD Drive Problems

The DVD drive cannot read a disc.

- Make sure that the disc is correctly seated in the tray, with the label facing up.
- Make sure that the disc is not dirty. Clean the disc with a disc cleaning kit, available in most computer stores.
- Make sure that the DVD drive driver is installed correctly.
- Make sure that the computer supports the disc or the files contained.

You cannot eject a disc.

- The disc is not properly seated in the drive. Manually release the disc following the method described next:
 1. Turn off the computer.
 2. Insert a small rod, such as a straightened paperclip, into the drive's manual eject hole and push firmly to release the tray.
 3. Pull the tray out until fully extended, and then remove the disc.



Display Problems

Nothing appears on the screen.

- During operation, the screen may automatically turn off as a result of power management. Press any key to see if the screen comes back.

- The brightness level might be too low. Increase brightness by pressing the Fn+F7 hot key.
- The display output might be set to an external device. To switch the display back to the LCD, press the Fn+F5 hot key or change the display through the Display Settings Properties of Windows.

The characters on the screen are dim.

- Adjust the brightness and/or contrast.

Bad dots appear on the display at all times.

- A small number of missing, discolored, or bright dots on the screen are an intrinsic characteristic of TFT LCD technology. It is not regarded as a LCD defect.

The external monitor displays nothing.

- Make sure that the monitor is turned on.
- Make sure that the monitor's signal cable is properly connected.
- Switch the display to the monitor by pressing the Fn+F5 hot key or change the display through the Display Settings Properties of Windows.

Simultaneous display/multi-display does not work.

- Make sure that you turn on the external monitor before turning on the computer.
- Press the Fn+F5 hot key to toggle through the display options or change the Display Settings Properties of Windows.

ExpressCard Problems

The ExpressCard does not work.

- Make sure that the ExpressCard is correctly seated.
- If the card requires an IRQ (Interrupt ReQuest), make sure that there is one available.

The ExpressCard stops communicating properly.

- The application may have been reset when the computer is turned off or in Sleep mode. Exit and restart the application.

Hardware Device Problems

The computer does not recognize a newly installed device.

- The device may not be correctly configured in the BIOS Setup program. Run the BIOS Setup program to identify the new type.
- Make sure if any device driver needs to be installed. (Refer to the documentation that came with the device.)
- Make sure if the device needs any jumper or switch settings. (Refer to the documentation that came with the device.)
- Check the cables or power cords for correct connections.
- For an external device that has its own power switch, make sure that the power is turned on.

Hard Disk Drive Problems

The hard disk drive error message appears on the screen.

- The hard disk drive has defects. Ask your dealer for help.

The hard disk drive operations seem slow.

- The data files stored on the hard disk drive may be fragmented. Use a tool such as Window's **Disk Defragmenter** to defragment the files.

The hard disk drive in-use indicator glows without blinking.

- The data files stored on the hard disk drive may be fragmented. Use a tool such as Window's **Disk Defragmenter** to defragment the files.

Keyboard, Mouse, and Touchpad Problems

The keyboard does not respond.

- Try connecting an external keyboard. If it works, contact an authorized dealer, as the internal keyboard cable might be loose.

The numeric keypad is disabled.

- Make sure that the Num Lock is switched on. (Check if the Num Lock Indicator  glows or not.)

The external keyboard does not work.

- Make sure that the keyboard cable is properly connected.

The USB mouse does not work.

- Make sure that the mouse cable is properly connected.

The touchpad does not work, or the pointer is difficult to control with the touchpad.

- Make sure that the pointing device driver is correctly installed.
- Make sure that the touchpad is clean.

LAN Problems

I cannot access the network.

- Make sure that the Ethernet driver is correctly installed.
- Make sure that the LAN cable is properly connected to the RJ-45 connector and the network hub.
- Make sure that the network configuration is appropriate.
- Make sure that the user name or password is correct.

WLAN Problems

I cannot use the WLAN feature.

- Make sure that the mini PCI-E WLAN card is correctly installed.
- Make sure that the necessary driver(s) is correctly installed.
- Make sure that the WLAN feature is turned on.

Transmission quality is poor.

- Your computer may be in an out-of-range situation. Move your computer closer to the Access Point or another WLAN device it is associated with.
- Check if there is high interference around the environment and solve the problem as described next.

Radio interference exists.

- Move your computer away from the device causing the radio interference such as microwave oven and large metal objects.
- Plug your computer into an outlet on a different branch circuit from that used by the affecting device.
- Consult your dealer or an experienced radio technician for help.

I cannot connect to another WLAN device.

- Make sure that the WLAN feature is turned on.
- Make sure that the SSID setting is the same for every WLAN device in the network.
- Your computer is not recognizing changes. Restart the computer.
- Make sure that the IP address or subnet mask setting is correct.

I cannot communicate with the computer in the network when Infrastructure mode is configured.

- Make sure that the Access Point your computer is associated with is powered on and all the LEDs are working properly.

- If the operating radio channel is in poor quality, change the Access Point and all the wireless station(s) within the BSSID to another radio channel.
- Your computer may be in an out-of-range situation. Move your computer closer to the Access Point it is associated with.
- Make sure that your computer is configured with the same security option (encryption) to the Access Point.
- Use the Web Manager/Telnet of the Access Point to check whether it is connected to the network.
- Reconfigure and reset the Access Point.

I cannot access the network.

- Make sure that the necessary driver(s) is correctly installed.
- Make sure that the network configuration is appropriate.
- Make sure that the user name or password is correct.
- You have moved out of range of the network.
- Turn off power management.

Power Management Problems

The computer does not enter Sleep or Hibernation mode automatically.

- If you have a connection to another computer, the computer does not enter Sleep or Hibernation mode if the connection is actively in use.
- Make sure that the Sleep or Hibernation time-out is enabled.

The computer does not enter Sleep or Hibernation mode immediately.

- If the computer is performing an operation, it normally waits for the operation to finish.

The computer does not resume from Sleep or Hibernation mode.

- The computer automatically enters Sleep or Hibernation mode when the battery pack is empty. Do any one of the following:
 - Connect the AC adapter to the computer.
 - Replace the empty battery pack with a fully charged one.

The computer does not enter Hibernation mode with the Fn+F12 hot keys.

- Make sure that the Hibernation function is specified for the sleep button.
- You might be using an ExpressCard that prevents the computer from entering Hibernation mode. To enter the mode, stop the communication program and then remove the card or stop the card.

Software Problems

An application program does not work correctly.

- Make sure that the software is correctly installed.
- If an error message appears on the screen, consult the software program's documentation for further information.
- If you are sure the operation has stop, reset the computer. (See "Resetting the Computer" later in this chapter.)

Sound Problems

No sound is produced.

- Make sure that the volume control is not set too low.
- Make sure that the audio driver is correctly installed.
- Make sure that the computer is not in Sleep mode.
- If using an external speaker, make sure that the speaker is properly connected.

Distorted sound is produced.

- Make sure that the volume control is not set too high or too low. In most cases, a high setting can cause the audio electronics to distort the sound.

The sound system does not record.

- Adjust the playback or recording sound levels.

The external microphone or audio device does not work.

- Make sure that the microphone is connected to the proper connector on the computer.
- Make sure that your computer is equipped with the driver needed.
- Click the speaker symbol on the taskbar and check the Windows volume control.
- Check the volume control of your computer.

Startup Problems

When you turn on the computer, it does not respond and the Power Indicator does not light.

- If you are using an external AC power, make sure that the AC adapter is correctly and securely connected. If so, make sure that the electrical outlet works properly.
- If you are using the battery power, make sure that the battery is not discharged.

When you turn on the computer, it stops after POST.

- Restart your computer.

The message “Operating system not found” appears on the screen after you turn on the computer.

- If this message appears when you are booting from the hard disk, insert a bootable disc in the DVD drive and check the condition of the hard disk.

The message “Invalid system disk” or “Disk error” appears on the screen after you turn on the computer.

- If you are deliberately trying to boot from a disc, replace the disc with a bootable one and press any key to continue booting.
- If this message appears when you are booting from the hard disk, insert a bootable disc in the DVD drive and check the condition of the hard disk.

Other Problems

The date/time is incorrect.

- Correct the date and time via the operating system or BIOS Setup program.
- After you have performed everything as described above and still have the incorrect date and time every time you turn on the computer, the RTC (Real-Time Clock) battery is at the end of its life. Call an authorized dealer to replace the RTC battery.

Resetting the Computer

You may have to reset (reboot) your computer on some occasions when an error occurs and the program you are using hangs up.

If the computer operation seems to hang up, first wait. It is possible that the computer is processing data. Periodically check the hard disk drive in-use indicator, if it flashes irregularly, the program may be accessing data and preventing you from using the keyboard. If you are sure the operation has stopped and you cannot use the “restart” function of the operating system, reset the computer.

Reset the computer by any one of these methods:

- Press Ctrl+Alt+Del.
- If the above action does not work, turn off the computer. Wait for at least five seconds and turn it on again.

| **CAUTION:** Resetting will cause any unsaved data to be lost.

Specifications

| NOTE: Specifications are subject to change without any prior notice.

Parts		Specifications
CPU		45nm Intel® Core™ 2 Duo processor (Penryn) 1066 MHz FSB (Front Side Bus), Thermal specifications 35 W
Chipset	NorthBridge	NVIDIA® MCP79MH
	SouthBridge	NVIDIA® MCP79MH
ROM BIOS		1 MB Flash EEPROM
RAM	System	Up to 4 GB, 2 × 200-pin DDRII 800 MHz SO-DIMM sockets, 1.25-inch height memory module support
Display	Panel	18.4-inch TFT LCD, resolution up to 1680×945 pixel (16:9)
	Video controller	Discrete NVIDIA® Geforce GO 9600GS with 512 MB GDDRII or, UMA NVIDIA® Geforce GO 9100M G (depending on your model)
	Video ports	VGA port, HDMI port
Audio	Audio subsystem	Azalia interface, 5.1-channel analog output
	Audio ports	Three audio ports for Headphone / Mic-in / S/PDIF
	Speakers	2 × 2.5 Watt stereo
	Subwoofer	3 Watt
	Microphone	Internal
Keyboard		Standard keys, numeric keypad, 12 function keys, a special Fn (Function) key and Windows keys
Multimedia buttons		Hybrid boost (availability depends on your model), Media, play/pause, stop, previous track, next track
Pointing device		Underplastic touchpad with 2 buttons
Storage device	Hard disk drive	2.5-inch diameter, 9.5 mm high, SATA interface, 5400 rpm support
	Optical drive	DVD Super Multi (12.7 mm high)
ExpressCard/54		ExpressCard/34 / ExpressCard/54 support
Card Reader		SD / MS / MS Pro / MMC

Parts		Specifications
I/O ports		3 × USB ports (USB 2.0 support), RJ-45 port, eSATA/USB combo port
LAN		10/100/1000 Mbps
Wireless LAN		One mini PCI-E slot for full/half-size wireless LAN card, compliant with IEEE 802.11b/g/n
Bluetooth (option)		Specification 2.1 module (EDR)
Camera		1.3 M webcam
Security		Kensington lock
Power	AC adapter	Universal AC adapter 90 Watt; input: 100~240 Volt, output: 19 Volt
	Battery	6-cell Li-ion, 4400 mAH (average) 4200 mAH (minimum) / 11.1 V 9-cell Li-ion, 6600 mAH (average) 6300 mAH (minimum) / 11.1 V
Dimension (W×D×H)		441×298.5×25~39 mm (17.36×11.75×0.98~1.54 inch)
Weight		3.7 kg (8.16 lb)
Environment	Temperature	Operating: 0 °C (32 °F) to 35 °C (95 °F) Storage: -20 °C (-4 °F) to 60 °C (140 °F)
	Humidity	Operating: 10 % to 90 % non-condensing Storage: 5 % to 95 % non-condensing

Regulatory Information

This appendix provides regulatory statements and safety notices on your computer.

NOTE: Marking labels located on the exterior of your computer indicate the regulations that your model complies with. Please check the marking labels and refer to the corresponding statements in this appendix. Some notices apply to specific models only.

On the Use of the System

Class B Regulations

USA

Federal Communications Commission Radio Frequency Interference Statement

NOTE:

This equipment has been tested and found to comply with the limits for a Class B digital device pursuant to Part 15 of the FCC Rules. These limits are designed to provide reasonable protection against harmful interference in a residential installation. This equipment generates, uses, and can radiate radio frequency energy and, if not installed and used in accordance with the instructions, may cause harmful interference to radio communications. However, there is no guarantee that interference will not occur in a particular installation. If this equipment does cause harmful interference to radio or television reception, which can be determined by turning the equipment off and on, the user is encouraged to try to correct the interference by one or more of the following measures:

- Reorient or relocate the receiving antenna.
- Increase the separation between the equipment and receiver.
- Connect the equipment into an outlet on a circuit different from that to which the receiver is connected.
- Consult the dealer or an experienced radio/TV technician for help.

Any changes or modifications not expressly approved by the manufacturer could void the user's authority to operate the equipment.

Please note:

The use of a non-shielded interface cable with this equipment is prohibited.

Canada

Canadian Department of Communications Radio Interference Regulations Class B Compliance Notice

This Class B digital apparatus meets all requirements of the Canada Interference-Causing equipment regulations.

Cet appareil numérique de Classe B respecte toutes les exigences du Règlement Canadien sur le matériel brouilleur.

This digital apparatus does not exceed the Class B limits for radio noise emissions from digital apparatus set out in the Radio Interference Regulations of the Canadian Department of Communications.

Le présent appareil numérique n'émet pas de bruits radioélectriques dépassant les limites applicables aux appareils numériques de la classe B prescrites dans le Règlement sur le brouillage radioélectrique édicté par le ministère des Communications du Canada.

Safety Notices

About the Battery

Caution Texts Concerning Lithium Batteries

DANISH

ADVARSEL! Lithiumbatteri – Eksplosionsfare ved fejlagtig håndtering. Udskiftning må kun ske med batteri af samme fabrikat og type. Levér det brugte batteri tilbage til leverandøren.

NORWEGIAN

ADVARSEL: Eksplosjonsfare ved feilaktig skifte av batteri. Benytt samme batteritype eller en tilsvarende type anbefalt av apparatfabrikanten. Brukte batterier kasseres i henhold til fabrikantens instruksjoner.

SWEDISH

VARNING: Explosionsfara vid felaktigt batteribyte. Använd samma batterityp eller en ekvivalent typ som rekommenderas av apparattillverkaren. Kassera använt batteri enligt fabrikantens instruktion.

FINNISH

VAROITUS: Paristo voi räjähtää, jos se on virheellisesti asennettu. Vaihda paristo ainoastaan valmistajan suosittelemaan tyyppiin. Hävitä käytetty paristo valmistajan ohjeiden mukaisesti.

ENGLISH

CAUTION: Danger of explosion if battery is incorrectly replaced. Replace only with the same or equivalent type recommended by the equipment manufacturer. Discard used batteries according to manufacturer's instructions.

DEUTSCH

VORSICHT: Explosionsgefahr bei unsachgemäßem Austausch der Batterie. Ersatz nur durch denselben oder einen vom Hersteller empfohlenen gleich-wertigen Typ. Entsorgung gebrauchter Batterien nach Angaben des Herstellers.

FRENCH

ATTENTION: Il y a danger d'explosion s'il y a remplacement incorrect de la batterie. Remplacer uniquement avec une batterie du même type ou d'un type équivalent recommandé par le constructeur. Mettre au rebut les batteries usagées conformément aux instructions du fabricant.

Attention (for USA Users)

The product that you have purchased contains a rechargeable battery. The battery is recyclable. At the end of its useful life, under various state and local laws, it may be illegal to dispose of this battery into the municipal waste stream. Check with your local solid waste officials for details in your area for recycling options or proper disposal.

About the AC Adapter

- Use only the AC adapter supplied with your computer. Use of another type of AC adapter will result in malfunction and/or danger.
- Do not use the adapter in a high moisture environment. Never touch the adapter when your hands or feet are wet.
- Allow adequate ventilation around the adapter when using it to operate the device or charge the battery. Do not cover the AC adapter with paper or other objects that will reduce cooling. Do not use the AC adapter while it is inside a carrying case.
- Connect the adapter to a proper power source. The voltage requirements are found on the product case and/or packaging.
- Do not use the adapter if the cord becomes damaged.
- Do not attempt to service the unit. There are no serviceable parts inside. Replace the unit if it is damaged or exposed to excess moisture.

On the Use of the RF Device

| **NOTE:** The information in this section applies to models with the wireless LAN module.

USA and Canada Safety Requirements and Notices

IMPORTANT NOTE: To comply with FCC RF exposure compliance requirements, the antenna used for this transmitter must be installed to provide a separation distance of at least 20 cm from all persons and must not be co-located or operating in conjunction with any other antenna or transmitter.

Radio Frequency Interference Requirements and SAR

The FCC with its action in ET Docket 93-62 has adopted a safety standard for human exposure to Radio Frequency (RF) electromagnetic energy emitted by FCC certified equipment. The wireless LAN module meets the Human Exposure limits found in OET Bulletin 65, 2001, and ANSI/IEEE C95.1, 1992. Proper operation of this radio according to the instructions found in this manual will result in exposure substantially below the FCC's recommended limits. The following safety precautions should be observed:

- Do not touch or move antenna while the unit is transmitting or receiving.
- Do not hold any component containing the radio such that the antenna is very close or touching any exposed parts of the body, especially the face or eyes, while transmitting.
- Do not operate the radio or attempt to transmit data unless the antenna is connected; if not, the radio may be damaged.

Use in specific environments:

- The use of wireless devices in hazardous locations is limited by the constraints posed by the safety directors of such environments.
- The use of wireless devices on airplanes is governed by the Federal Aviation Administration (FAA).

- The use of wireless devices in hospitals is restricted to the limits set forth by each hospital.

Antenna use:

- In order to comply with FCC RF exposure limits, low gain integrated antennas should be located at a minimum distance of 20 cm (8 inches) or more from the body of all persons.
- High-gain, wall-mount, or mast-mount antennas are designed to be professionally installed and should be located at a minimum distance of 30 cm (12 inches) or more from the body of all persons. Please contact your professional installer, VAR, or antenna manufacturer for proper installation requirements.

Explosive Device Proximity Warning

WARNING: Do not operate a portable transmitter (such as a wireless network device) near unshielded blasting caps or in an explosive environment unless the device has been modified to be qualified for such use.

Antenna Warning

WARNING: To comply with the FCC and ANSI C95.1 RF exposure limits, it is recommended that the antenna for this device be installed so as to provide a separation distance of at least 20 cm (8 inches) from all persons and that the antenna must not be co-located or operating in conjunction with any other antenna or radio transmitter. It is recommended that the user limit exposure time if the antenna is positioned closer than 20 cm (8 inches).

Use on Aircraft Caution

CAUTION: Regulations of the FCC and FAA prohibit airborne operation of radio-frequency wireless devices because their signals could interfere with critical aircraft instruments.

EMC Requirements

This device uses, generates and radiates radio frequency energy. The radio frequency energy produced by this device is well below the maximum exposure allowed by the Federal Communications Commission (FCC).

This device complies with the limits for a Class B digital device pursuant to Part 15 subpart C of the FCC Rules and Regulations. Operation is subject to the following two conditions:

- (1) This device may not cause harmful interference.
- (2) This device must accept any interference received, including interference that may cause undesired operation.

The FCC limits are designed to provide reasonable protection against harmful interference when the equipment is installed and used in accordance with the instruction manual and operated in a commercial environment. However, there is no guarantee that interference will not occur in a particular commercial installation, or if operated in a residential area.

If harmful interference with radio or television reception occurs when the device is turned on, the user must correct the situation at the user's own expense. The user is encouraged to try one or more of the following corrective measures:

- Reorient or relocate the receiving antenna.
- Increase the separation between the equipment and receiver.
- Connect the equipment into an outlet on a circuit different from that to which the receiver is connected.
- Consult the dealer or an experienced radio/TV technician for help.

CAUTION: The Part 15 radio device operates on a non-interference basis with other devices operating at this frequency. Any changes or modification to said product not expressly approved by the manufacturer could void the user's authority to operate this device.

Canada Radio Frequency Interference Requirements

To prevent radio interference to the licensed service, this device is intended to be operated indoors and away from windows to provide maximum shielding. Equipment (or its transmit antenna) that is installed outdoors is subject to licensing.

Pour empêcher que cet appareil cause du brouillage au service faisant l'objet d'une licence, il doit être utilisé à l'intérieur et devrait être placé loin des fenêtres afin de fournir un écran de blindage maximal. Si le matériel (ou son antenne d'émission) est installé à l'extérieur, il doit faire l'objet d'une licence.

European Union CE Marking and Compliance Notices

Statements of Compliance

English

This product follows the provisions of the European Directive 1999/5/EC.

Danish

Dette produkt er i overensstemmelse med det europæiske direktiv 1999/5/EC.

Dutch

Dit product is in navolging van de bepalingen van Europees Directief 1999/5/EC.

Finnish

Tämä tuote noudattaa EU-direktiivin 1999/5/EC määräyksiä.

French

Ce produit est conforme aux exigences de la Directive Européenne 1999/5/EC.

German

Dieses Produkt entspricht den Bestimmungen der Europäischen Richtlinie 1999/5/EC.

Greek

Το προϊόν αυτό πληροί τις προβλέψεις της Ευρωπαϊκής Οδηγίας 1999/5/EC.

Icelandic

Þessi vara stendst reglugerð Evrópska Efnahags Bandalagsins númer 1999/5/EC.

Italian

Questo prodotto è conforme alla Direttiva Europea 1999/5/EC.

Norwegian

Dette produktet er i henhold til bestemmelsene i det europeiske direktivet 1999/5/EC.

Portuguese

Este produto cumpre com as normas da Diretiva Européia 1999/5/EC.

Spanish

Este producto cumple con las normas del Directivo Europeo 1999/5/EC.

Swedish

Denna produkt har tillverkats i enlighet med EG-direktiv 1999/5/EC.

Local Restrictions of 802.11b/g/n Radio Usage

802.11a wireless LAN devices: For operation within 5.15 ~ 5.25 GHz frequency range, it is restricted to indoor usage environments, and the antenna of this device must be integral.

CAUTION: Due to the fact that the frequencies used by 802.11b/g/n wireless LAN devices may not yet be harmonized in all countries, 802.11b/g/n products are designed for use only in specific countries or regions, and is not allowed to be operated in countries or regions other than those of designated use. As a user of these products, you are responsible for ensuring that the products are used only in the countries or regions for which they were intended and for verifying that they are configured with the correct selection of frequency and channel for the country or region of use. Any deviation from permissible settings and restrictions in the country or region of use could be an infringement of local law and may be punished as such.

The European variant is intended for use throughout the European Economic Area. However, authorization for use is further restricted in particular countries or regions within countries, as follows:

General

European standards dictate maximum radiated transmit power of 100 mW Effective Isotropic Radiated Power (EIRP) and the frequency range 2400 – 2483.5 MHz.

Belgium and the Netherlands

In Belgium and the Netherlands, the product may not be used outdoors. See the instructions next under the heading “Turning Off the Wireless LAN Radio.”

France

Departments in Which the Wireless LAN Module Can Be Used (Indoors Only)

The wireless LAN module can currently be used indoors only in the following 38 departments of mainland France. Please turn off your wireless LAN radio when operating the device in areas/places other than the 38 departments listed:

01	Ain Orientales	36	Indre	66	Pyrénées
02	Aisne	37	Indre et Loire	67	Bas Rhin
03	Allier	41	Loir et Cher	68	Haut Rhin
05	Hautes Alpes	42	Loire	70	Haute Saône
08	Ardennes	45	Loiret	71	Saône et Loire
09	Ariège	50	Manche	75	Paris
11	Aude	55	Meuse	82	Tarn et Garonne
12	Aveyron	58	Nièvre	84	Vaucluse
16	Charente	59	Nord	88	Vosges
24	Dordogne	60	Oise	89	Yonne
25	Doubs	61	Orne	90	Territoire de Belfort
26	Drôme	63	Puy du Dôme	94	Val de Marne
32	Gers	64	Pyrénées Atlantique		

Departments in Which the Wireless LAN Module's Maximum EIRP Not Shown in the Previous Table

Frequency Ranges (MHz)	Indoors	Outdoors
2400 – 2446.5	10 mW	Not permitted
2446.5 – 2483.5	100 mW	100 mW on private property with Ministry of Defense approval

Turning Off the Wireless LAN Radio

NOTE: Turning the wireless LAN radio off is not the same as disabling the wireless LAN card. It is not necessary to disable the card to meet the regulatory requirements.

While operating the computer in those French departments that do not allow use of the wireless LAN equipment, the user of the equipment must turn off the wireless LAN radio in order to comply with local regulations (see Chapter 2 for more information).

Index

—A—

- AC adapter, 3-2, A-2
 - Connecting, 1-2
- AC power, 3-2
 - Connecting, 1-2
- ACPI, 3-9
- Adobe Acrobat Reader, 6-3
- Antenna warning, B-6
- Audio connector, 2-17
- Audio driver, 6-3
- Audio subsystem
 - Connecting external audio device, 2-18
 - Driver installation, 6-3
 - Feature, 2-17
 - Troubleshooting, 8-11

—B—

- Battery charge
 - Indicator, 1-11, 3-3
- Battery low, 3-7
- Battery pack, 1-8, A-2
 - Battery low, 3-7
 - Charging, 3-3
 - Checking battery level, 3-4
 - Initializing, 3-4
 - Replacing, 3-5
 - Safety notices, B-3
 - Taking care, 7-6
 - Troubleshooting, 8-4

- BIOS Setup, 5-1
 - Advanced menu, 5-6
 - Boot menu, 5-9
 - Exit menu, 5-10
 - Exiting, 5-10
 - GPU, 5-6
 - Legacy USB, 5-6
 - Main menu, 5-5
 - Password, 5-8
 - SATA device, 5-6
 - Security menu, 5-8
 - Starting, 5-2
- Bluetooth feature
 - Connect to Bluetooth device, 2-24
 - Driver installation, 6-3
 - Hot key, 2-8
 - Indicator, 1-11
 - Sending file, 2-27
 - Troubleshooting, 8-4
 - Turning off, 2-24
 - Turning on, 2-24
 - Using, 2-24
- Bluetooth module
 - Compartment, 1-8
- Boot sequence, 5-9
- Booting, 2-2
- Brightness
 - Hot key, 2-9
- Buttons
 - Multimedia, 2-4

C

- Camera, 1-10
 - Driver installation, 6-3
- Canada
 - Class B compliance notice, B-3
 - RF interference requirements, B-8
- Caps Lock
 - Indicator, 1-11
- Card Reader, 1-7
 - Driver installation, 6-3
 - Inserting a card, 4-13
 - Removing a card, 4-13
 - Using, 4-12
- CD. *See* DVD drive
- Charging, 3-3
- Chipset driver, 6-3
- Class 1 laser product, 2-14
- Cleaning the computer, 7-6
- Click, 2-12
- Combo drive. *See* DVD drive
- Connecting external device
 - eSATA device, 4-8
 - Monitor, 4-2
 - USB device, 4-7
- Connector
 - Audio, 2-17
 - eSATA-USB combo, 1-7
 - HDMI, 1-7
 - Headphone, 1-6, 2-18
 - LAN, 1-7
 - Microphone, 1-6, 2-18
 - Power, 1-6
 - S/PDIF, 1-6, 2-18
 - VGA, 1-7
- Copyright protection
 - Macrovision Corp., 2-14
- Cover
 - Opening, 1-4
- CPU, A-1
 - Compartment, 1-8
- Cursor control keys, 2-7

D

- Date
 - BIOS Setup, 5-5
 - Troubleshooting, 8-13
- DC power, 3-2
- Dimension of computer, A-2
- Display
 - Troubleshooting, 8-6
- Display mode, 2-16
- Display output
 - Hot key, 2-9
- Double-click, 2-12
- Drag and drop, 2-12
- Drive D, 2-14
- Drive E, 4-13
- Driver disc
 - Using, 6-2
- Driver installation, 6-1
- Driver OS support, 6-2
- DVD drive, 1-6
 - Inserting a disc, 2-14
 - Troubleshooting, 8-5
 - Using, 2-14
- DVD Dual drive. *See* DVD drive

E

- EEPROM, A-1
- EMC requirements, B-7
- Environmental specifications, A-2
- eSATA device
 - Connecting, 4-8
- eSATA-USB combo connector, 1-7, 4-8
- EU
 - CE marking and compliance notices, B-8
- Euro symbol, 2-9
- ExpressCard
 - Inserting, 4-10
 - Removing, 4-11
 - Slot, 1-7
 - Troubleshooting, 8-7
 - Type, 4-9
 - Using, 4-9

External monitor
Connecting, 4-2

F

FCC
Class B regulations, B-2
FDA regulations, 2-14
Fn key, 2-7
Function key, 2-7

G

GPU
BIOS Setup, 5-6
Graphics mode, 2-5

H

Hard disk drive
Compartment, 1-9
Indicator, 1-12
Troubleshooting, 8-7
HDMI audio driver, 6-3
HDMI connector, 1-7, 4-2
HDMI video
Sound output, 4-3
Headphone connector, 1-6, 2-18
Hibernation mode, 2-3, 3-9, 3-10
Troubleshooting, 8-10
Hot key
Bluetooth feature, 2-8
Brightness, 2-9
Display output, 2-9
LCD, 2-9
Multimedia button & indicator, 2-9
Mute, 2-9
Sleep mode, 2-9
Volume, 2-8
WLAN feature, 2-8
Humidity, A-2

I

Indicator
Battery charge, 1-11, 3-3
Bluetooth feature, 1-11
Caps Lock, 1-11
Hard disk drive, 1-12
Num Lock, 1-11
Optical drive, 1-12
WLAN radio, 1-11

K

Kensington lock, 1-7, 7-4
Keyboard, 1-11
Troubleshooting, 8-8
Using, 2-7

L

LAN, 2-21
Connector, 1-7
Troubleshooting, 8-8
LCD, 1-10, 2-16
Switching on and off with hot key, 2-9
Legacy USB
BIOS Setup, 5-6
Location of the computer, 7-5
Low battery. *See* Battery low

M

Memory module
Slot, 1-8
Memory Stick. *See* Storage card
Memory Stick PRO. *See* Storage card
Microphone, 1-11, 2-17
Microphone connector, 1-6, 2-18
Mouse
Troubleshooting, 8-8
Multimedia button, 1-11
Multimedia button & indicator
Hot key, 2-9

Multimedia buttons
Using, 2-4
MultiMediaCard. *See* Storage card
Mute
Hot key, 2-9

—N—

Network. *See* LAN
Num lock, 2-8
Num Lock
Indicator, 1-11
Numeric key, 2-8

—O—

Operating system, 1-5, 2-2
Optical drive
Indicator, 1-12

—P—

Password, 5-8
Point, 2-12
Port
USB, 1-6, 1-7
POST, 1-5
Power
Specification, A-2
Power button, 1-10, 2-2
Power connector, 1-6
Power Management, 3-9
Troubleshooting, 8-10
Power source, 2-5
Power-On Self Test. *See* POST

—R—

RAM, A-1
Rebooting, 8-14
Resetting, 8-14
Restarting, 8-14

RF device
Safety Requirements and Notices, B-5
RJ-45, 1-7, 2-21
ROM BIOS, A-1

—S—

S/PDIF connector, 1-6, 2-18
SATA device
BIOS Setup, 5-6
Saving power, 3-11
Screen. *See* LCD
Scroll, 2-12
Secure Digital. *See* Storage card
Security
Protecting the computer with lock, 7-4
Protecting the computer with password,
7-3
Security Center
Protecting the computer, 7-2
Shutting down, 1-5, 2-2
Simultaneous display, 2-16
Sleep button, 2-9
Sleep mode, 2-2, 3-9
Troubleshooting, 8-10
Software
Troubleshooting, 8-11
Software driver, 6-1
Speaker, 1-10, 2-17
6-channel system, 2-19
Connecting external speakers, 2-18
Specifications, A-1
Startup, 2-2
Troubleshooting, 8-12
Storage card, 4-12
Inserting, 4-13
Removing, 4-13
Subwoofer, 1-8, 2-17
Super Multi drive. *See* DVD drive

—T—

Temperature, A-2
TFT, 2-16

- Time
 - BIOS Setup, 5-5
 - Troubleshooting, 8-13
- Touchpad, 1-12
 - Configuring, 2-13
 - Driver installation, 6-3
 - Troubleshooting, 8-8
 - Using, 2-11
- Traveling with the computer, 7-7
- Troubleshooting, 8-1
 - Battery problem, 8-4
 - Bluetooth feature problem, 8-4
 - Date problem, 8-13
 - Display problem, 8-6
 - DVD drive problem, 8-5
 - ExpressCard problem, 8-7
 - Hard disk drive problem, 8-7
 - Hardware problem, 8-7
 - Keyboard problem, 8-8
 - LAN problem, 8-8
 - Mouse problem, 8-8
 - Other problem, 8-13
 - Power Management problem, 8-10
 - Software problem, 8-11
 - Sound problem, 8-11
 - Startup problem, 8-12
 - Time problem, 8-13
 - Touchpad problem, 8-8
 - WLAN feature problem, 8-9
- Turning off, 1-5, 2-2
- Turning on, 1-4
- Typewriter key. *See* Keyboard

—U—

- Unpacking, 1-2
- Upgrading the computer, 4-14
- USB device
 - Connecting, 4-7

- USB port, 1-6, 1-7, 4-7

—V—

- VGA connector, 1-7
- VGA port, 4-2
- Video driver, 6-3
- Video subsystem
 - Configuring, 2-16
 - Driver installation, 6-3
 - Feature, 2-16
 - Video controller, A-1
- Volume
 - Hot key, 2-8

—W—

- Weight of computer, A-2
- Windows, 1-5
- Windows key, 2-10
- Windows Power Plan, 2-5
- Wireless network
 - Connecting, 2-22
- WLAN card
 - Slot, 1-8
- WLAN feature
 - Driver installation, 6-3
 - Hot key, 2-8
 - Troubleshooting, 8-9
 - Turning off, 2-22
 - Turning on, 2-22
 - Using, 2-21
- WLAN radio
 - France restrictions, B-10
 - Indicator, 1-11
 - Local restrictions, B-9