

PN 4000

PN 6000









User Manual

Content

General advice	54
Safety advice and important information	54
Overview of device	56
What's included?	56
Controls and connection ports	57
RCS 5100 remote control (optional)	61
Setup and installation	62
Getting started	62
Installation	63
Configuration	64
Settings	65
Display settings	65
Screen settings	67
Regional settings	68
Address book	69
Information	71
Sound	71
Change route – avoid traffic jams	72
Simulation	73
TMC (Traffic Message Channel)	74
Alert points displayed on the map	74
Position & speed/Select location	74
Select map	74
System ID	74
Default settings	75
Bluetooth settings	76
Toolbar	78
Set route criteria/route profile	79
Navigation	80
Entering a destination	80
Address book – Selecting an address	81
Geographical coordinates destination	82
POI – "Point of Interest" destination	82
Guidance – Map display	83
Multimedia menu	85
Music playback	86
Picture viewer	88
Games	89
Video player	89
Bluetooth	89
DVB-T digital television	92
GPS and TMC	100
Troubleshooting	102
Technical Data	103

Safety advice and important information

Before you start to install and use this navigation system, please familiarise yourself with its various components and functions. Please also read through the safety instructions carefully to avoid personal injury to yourself and others.

-  Do not expose the navigation system to high temperatures or extreme sunlight. Temperatures over 50°C can severely damage the navigation system, especially the lithium ion battery. The lithium ion battery can only be charged within a temperature range of 0-45°C. Please note the safety instructions when operating the battery!
-  The device is not splashproof and must therefore not be exposed to moisture, as this may result in damage.
-  GPS (Global Positioning System) is a satellite-based system that supports geographical and time-related information all around the world. The system is operated and controlled by the United States of America. The USA is also responsible for the availability and accuracy of this system. All changes to the GPS availability and accuracy as well as other factors from the surrounding environment can influence the operation of the navigation system. The supplier of this system does not accept any liability whatsoever for the availability and accuracy of GPS data.
-  When fixing the screen onto its mount in your vehicle, please note the following: Never adjust the screen by moving the navigation system itself; instead you should adjust the mount. Position the screen so that you are able to glance at the display quickly and easily. The device should also be positioned in a way that prevents reflections and glare from the screen. The screen should not be positioned so that it obstructs your view of things that are necessary for driving the vehicle (e.g. the view of the road or the vehicle's instruments) or the safety systems in your vehicle.
-  The navigation system does not take the relative safety of the suggested routes into consideration. Road closures, roadworks, height and weight restrictions, traffic and weather conditions or other factors that can influence the safety and the journey time of the route are not taken into consideration for the suggested routes. Use your own judgement to check the suitability of the suggested routes. If required, use the "Change Route" function to calculate alternatives to the original route. Alternatively take the road you prefer and the software will automatically perform a re-routing (i.e. calculate a new route based on your new position).
-  In certain areas, one-way streets, turning restrictions and no entry signs (e.g. pedestrian zones) cannot be accounted for. In such situations, pay particular attention to road signs and applicable road traffic regulations.
-  If you need the help of the emergency services (police, fire, ambulance, etc.), do not rely exclusively on the navigation system. Act at your own discretion and possibilities in order to find help in such situations.
-  Please ensure that every person intending to use the navigation system reads this safety information and the recommendations for operating the system beforehand.

**WEEE compliance**

All electrical and electronic equipment must be disposed of separately from general household waste using the sites designated by local authorities. If a product displays this symbol of a crossed-out rubbish bin, the product is subject to European Directive 2002/96/EC. The appropriate disposal and separate collection of used equipment serve to prevent potential harm to the environment and to health. They are a requirement for the re-use and recycling of used electrical and electronic equipment. For further information on disposing of your used equipment, please contact your local authority, your refuse collection service or the dealer you purchased the product from.

**CE quality mark**

This product satisfies the requirements for the CE quality mark for use in a home, office or commercial environment.

R&TTE directive

We, Siemens VDO Trading GmbH, declare that this device complies with the essential requirements and other pertinent regulations laid down in Directive 1999/5/EC.

The declaration of conformity can be requested from the following address:

Siemens VDO Trading GmbH, Kruppstraße 105, 60388 Frankfurt am Main, Germany.

**Batteries**

In many countries it is forbidden to dispose of empty batteries with normal household waste. Please find out the regulations that apply in your area regarding the disposal of used batteries/rechargeable batteries. Please also dispose of damaged batteries or batteries that are past their expiry date in a safe and suitable way.

What's included?

Your navigation system package includes the following parts:

- 1 Navigation system
- 2 Lithium ion battery
- 3 Mount with suction cup for attaching the device to the windscreen
- 4 12 V DC cable to power the navigation system from within the vehicle (adapter for cigarette lighter)
- 5 100/240 V AC adapter

⚠ You must not use any cables other than the supplied AC adapter and DC cable to power the device and to charge the battery!

- 6 Quick Start guide
- 7 SD card with map data
- 8 DVB-T aerial (with cable)
- 9 DVB-T aerial (without cable)

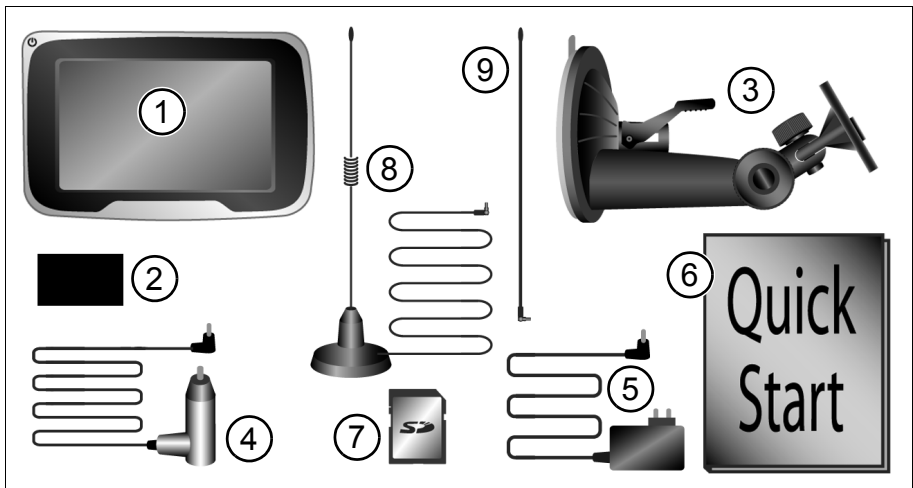

What you can get as an option:

- External GPS aerial
- Additional battery pack
- Active cradle (TMC or TMC+Bluetooth)
- Car connectivity cable
- Active DVB-T aerial (for improved reception in areas where the DVB-T signal is weak)
- Steering wheel remote control (infrared)

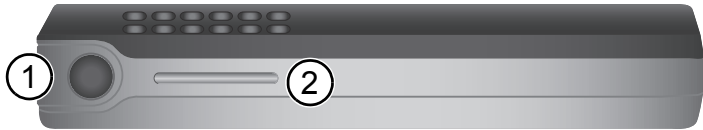

Top

- 1 Power button
 - Briefly press the power button to switch the navigation system to stand-by mode
 - Briefly press the button a second time to turn the system on again
 - Press and hold the button for approx. 3 seconds to turn off the navigation system
 - To turn the device back on again, press and hold the button for approx. 3 seconds. The navigation system will be completely restarted.
- 2 Light sensor: This sensor automatically adapts the brightness of the screen according to the surrounding light. This function can be activated/deactivated in the **Settings** menu.



Front

- 3 Display/touchscreen
- 4 Charging symbol. This status LED displays the following:
 - Green** The device is being powered by an external supply and battery is charged to at least 95% of total capacity.
 - Red** The device is being powered by an external supply and the battery is being charged.
 - Orange** The device is being powered by an external supply and no battery is inserted.
 - Off** The device is not being powered by an external supply.
- 5 Infrared sensor
This can be used in conjunction with an RCS 5100 steering wheel remote control (accessory)

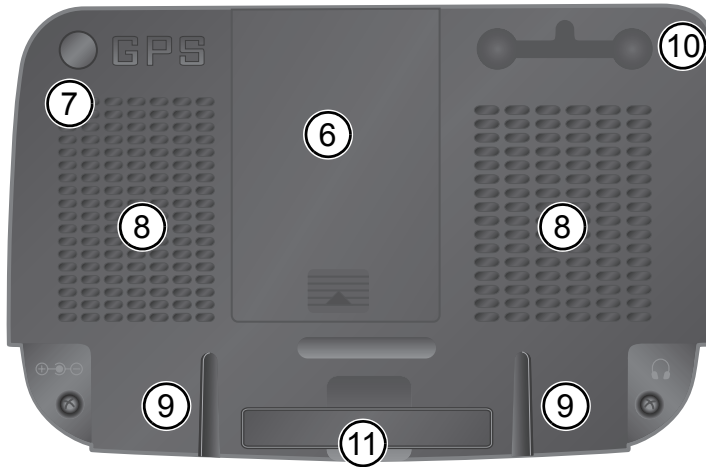

Back

- 6** Compartment for lithium ion battery (cover)
- 7** External GPS port
- 8** Loudspeaker
- 9** Grooves for cradle fixation
- 10** DVB-T aerial port (cover)
- 11** Foot (extractable)

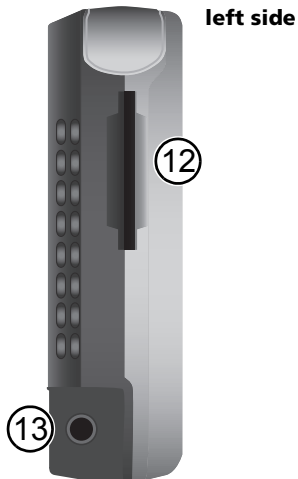

left side

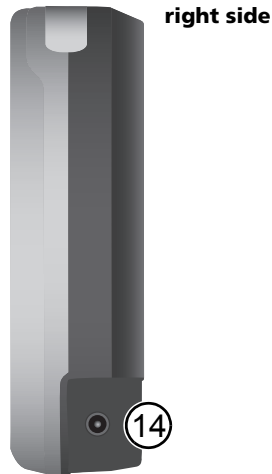

right side

- 12** Slot for SD card
- 13** Earphone socket

 Earphones/volume control: High volumes can damage or decrease the sensitivity of your hearing.

- 14** 100 V/240 V power adapter (optional) or 12 V cigarette lighter port

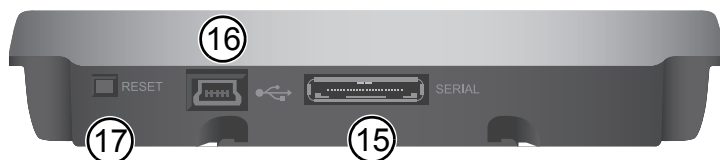

Bottom side

- 15** Serial port – only for active cradle (optional)
- 16** USB port for connection to your PC
- 17** Reset button: If the navigation system stops responding to your entries, you can reset the system by pressing this button (e.g. with a straightened-out paper clip or a pencil). The data you have saved will NOT be lost! Restart the navigation system by pressing the power button.

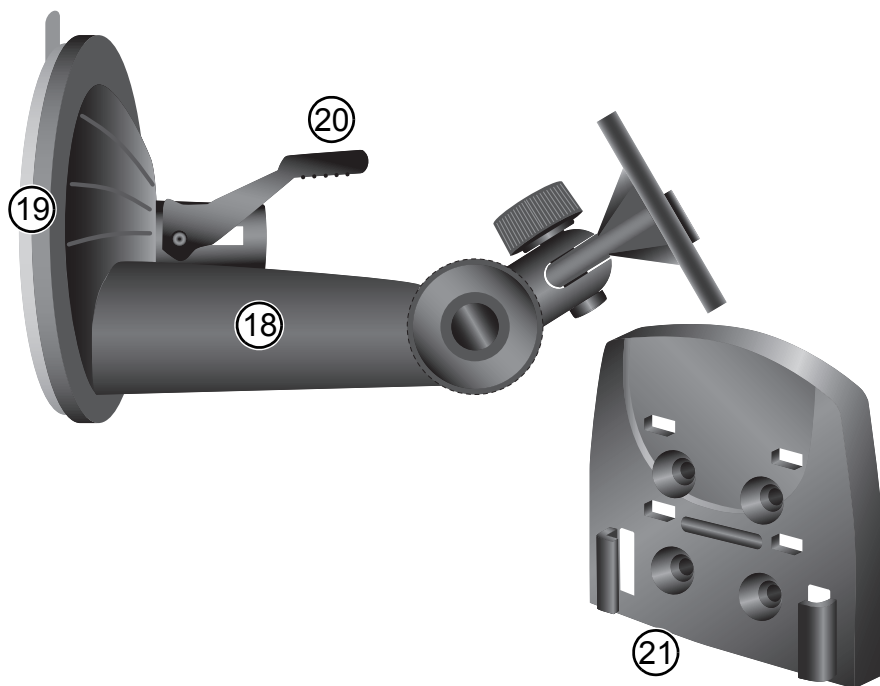

Mount

- 18** Base
- 19** Suction cup
- 20** Locking lever
- Mount with suction cup may vary from the picture.
- 21** Passive cradle (optional)

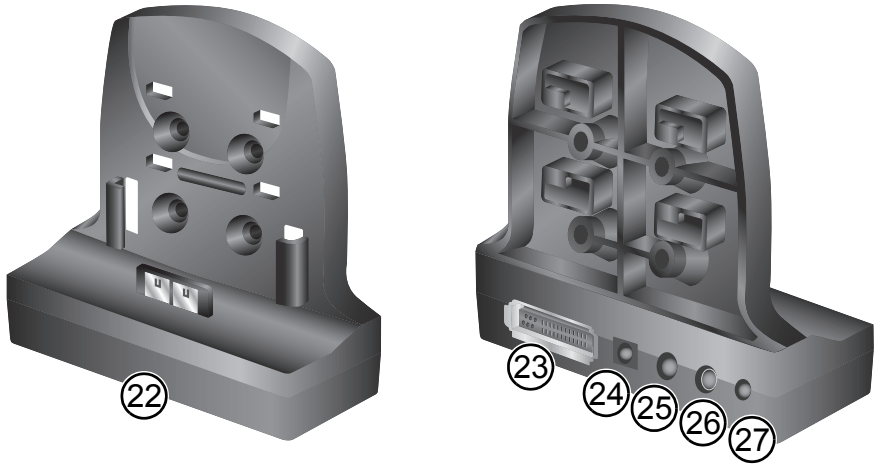

- 22** Active cradle (optional)
- 23** Car connectivity cable socket
- 24** 100 V/240 V power adapter (optional) or 12 V cigarette lighter port
- 25** Line-out/audio
- 26** TMC aerial port
- 27** Microphone-in/*Bluetooth* (optional)



TMC active cradle: Features marked with this symbol are only active if you have purchased a TMC active cradle and the navigation device is mounted in this cradle.



BT active cradle: Features marked with this symbol are only active if you have purchased a BT active cradle and the navigation device is mounted in this cradle.



BT and TMC buttons on the user interface of the navigation device can only be used if the device is being operated by the relevant active cradle.

RCS 5100 remote control (optional)

With the remote control placed on your steering wheel, you can easily operate the navigation system while driving. Set the mode switch (3) to Navigation.

- 1 If you press this button briefly the voice message will repeat itself. If you press and hold the button the alternative route planning menu is displayed.
- 2 You can use the cursor keys to navigate through the menus. In **Map display**, cursor left/right will zoom the map.
- 3 **Mode switch** (Navigation N / Audio A).
- 4 Confirm selections by pressing this button.
- 5 Press this button briefly to see the **Map display**. Pressing and holding the button opens the **Toolbar**.
- 6 Pressing this button reduces the navigation advice volume. In setting screens with sliders the button can be used to reduce the selected slider value.
- 7 Pressing this button increases the navigation advice volume. In setting screens with sliders the button can be used to increase the selected slider value.

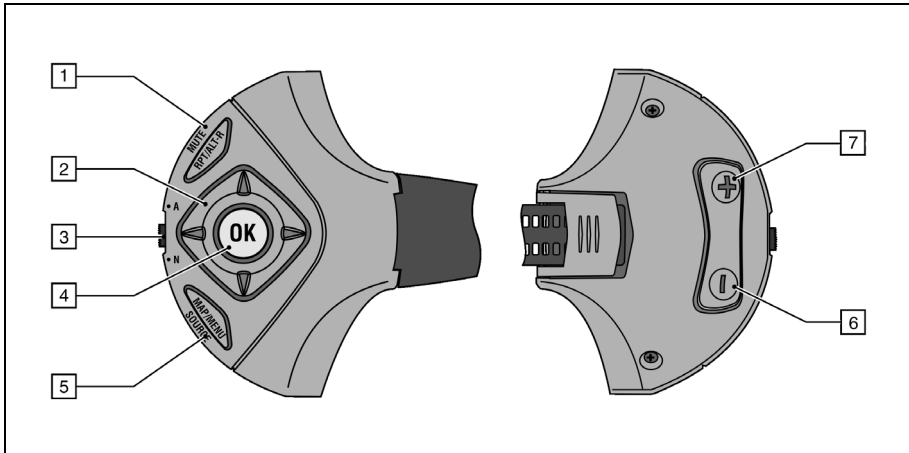

Getting started

Before you can switch on the navigation system for the first time, you must insert the battery. This is carried out with the following steps:

- Open the battery compartment.
- Push the battery into the battery compartment with the contacts facing downwards. You can now close the battery compartment.
- Connect the navigation system to the 12 V power supply in your vehicle. The battery will now start to charge. It takes approx. 8 hours to fully charge the battery.

The battery life without external power supply is approx. 5 hours for navigation and approx. 2 hours for DVB-T with the PN 4000 (approx. 6 hours for navigation and approx. 4 hours for DVB-T with the PN 6000). The battery life also depends on the display brightness you have selected.

- Insert the supplied SD card containing the maps into the SD card slot.



With an active cradle you can use the car battery/keys switch connection in combination with the optional car connectivity cable. The navigation device will automatically switch on or off by turning the car key in the ignition. Once the navigation device is inserted in the active cradle and the ignition is switched on, the battery is automatically charged.



When using a passive cradle:

- You must turn the device on and off using the power button.
- You can charge the battery by using the cigarette lighter cable



The battery must only be charged if someone is monitoring the device. Do not open the battery by force as this may release corrosive acid. Damaged batteries or batteries that are past their expiry date must no longer be used and should be disposed of in a safe and suitable way.



Installation

- Before attaching the cradle to the windscreen, clean the relevant windscreen area as well as the cradle's suction pad, and ensure they are free from grease and dust.
- Differences between daytime and nighttime temperatures and/or humidity and moisture may cause the vacuum under the suction cup to disintegrate. Therefore you should attach the navigation system so that it will not sustain damage if it falls off the windscreen. As a precautionary measure, you should detach the navigation system at night.
- Please do not use any cleaning agents or detergents to clean the screen and case of the device. The best method is to use a soft, damp cloth.

- ⚠ The device must not be attached in a position that obscures the view. Nor should the device be attached within the area in which the airbags open or within reach of the head or knees in the event of a collision.
- ⚠ Secure the device so that it will not slide around in the event of emergency braking or a collision.

To install the device in the vehicle, proceed as follows:

- Find a suitable place in the vehicle for attaching the cradle. The screen should be clearly visible from the driver's seat (with a clear view of the sky) but the device should not obscure the driver's view.
- Press the suction cup against the windscreen and push the lever towards the windscreen until it locks into place.
- Attach the navigation system to the cradle.



Dismounting: To detach the device, move the lever in the opposite direction and carefully pull the transparent rubber end of the suction cup to remove it from the window.



- ⚠ For safety reasons you should install the device and enter the required information in the system before you start your journey or when your vehicle is stationary.
- ⚠ The use of the navigation system does not under any circumstances release the driver from his/her personal responsibility. The applicable road traffic regulations and current traffic conditions always have priority. The information provided by the device is for orientation purposes only and is not binding.
- ⚠ Always check the information provided by the device (speed, remaining travelling time, distance, recommended route).
- ⚠ Only look at the screen when it is safe to do so. If you need to look at the screen for a longer period of time, stop the vehicle at an appropriate and safe place.
- ⚠ The touchscreen must not be operated with sharp or rough-edged objects as these can damage it.
- ⚠ Furthermore, if you plan to leave the vehicle unattended for a long period of time, you should remove the navigation system from the vehicle in order to avoid theft.

Configuration

- After switching on the navigation system, the legal disclaimer screen appears.
- Tap **OK** after reading the screen.
- As soon as the system is ready, the **Main menu** will appear on the screen.

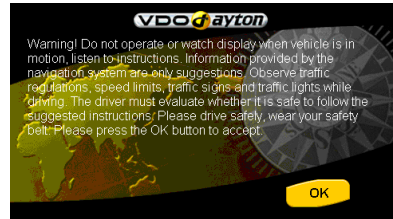

Touchscreen: The navigation system is equipped with a touchscreen. The icons on the screen function as buttons and should be tapped with your fingers. Do not touch the screen with sharp or rough-edged objects as these can damage the sensitive touchscreen display.

Main menu

The following functions are available in the **Main menu**:

Destination (page 80)



Tap the **Destination** button to have the navigation system to guide you from your present location to a specific destination. A submenu opens with further guidance functions and an address input field. For further information, please see "Navigation" page 80.



Home/Work



The **Home** and **Work** buttons allow you to store two frequently used addresses so you can call them up quickly.

Once you have entered your home or work address, the device will guide you to those locations from wherever you might be. Simply tap the **Home** or **Work** button in the **Main menu**. The addresses stored in these functions can be changed at any time. (See "Adding to the address book" on page 83.)

Map display (page 65)



Tap the Map display button to call up the relevant map view before or during guidance.

Settings (page 65)

Tap the **Settings** button to change basic settings e.g. language, volume, brightness, unit of measurement (kilometres or miles). A submenu appears with further guidance settings and further navigation system functions.

Multimedia (page 85)

Tap the **Multimedia** button to open the multimedia selection. A submenu opens with further Multimedia options and applications such as music playback or DVB-T TV.

Settings

Tap the **Settings** button to make your preferred settings. The first of three submenus is opened.



Tap the arrow button on the bottom right of the screen to scroll through the other pages of the submenu.



Tap **Back** in the top left corner of the screen to exit the current screen without saving the settings. This takes you back to the previous menu. If you tap **OK** the selection you have made is saved and you return to the previous menu.



What you select here can be changed at any time. Software updates may change the menu structure.

Display settings

Tap this button to open the map settings. The selected settings are marked and activated with a green tick.



Vehicle direction: Tap this button to select your preferred map orientation. If the green tick is set, the map display follows the travel direction of the vehicle. If no tick is set, the map is displayed with North at the top of the screen and the icon indicates the travel direction on the map.



3D display: Tap this button to view the map in 3D format. The map cannot be oriented northwards in 3D format. The *Vehicle direction* is deactivated.



Visual advice: Tap this button to indicate changes of direction in arrow format during Traffic Info On Route guidance.



Auto scale: Activate this function to automatically scale the map view. Scaling is carried out depending on the speed, and when approaching a crossing.



Full route display: Activate this option to clearly display the full remaining route with active guidance on the screen. The selected mode is indicated by a green tick. If you do not wish to use **Full route display**, deactivate the setting. The **Zoom in/out** function is not possible with this setting.



Current street: Tap this button to display the name of the street you are currently on. The street name is displayed at the bottom of the screen.



Current city: Tap this button to display the name of the city you are currently in. The street name is displayed at the bottom of the screen.



Next street: Tap this button to display the name of the street you will turn onto next at the top of the screen.



Lane guidance: This function advises on lane selection for motorways and rural roads based on the next direction change. Tap this button to use this function. The available lanes are displayed in the Traffic Info on Route and the preferred lane is indicated in green.



Destination arrow: Tap this button to have an arrow indicate the direction of the selected destination – relative to the travel direction – during Traffic Info on Route guidance.



TMC icons: Tap this button to have detailed information on TMC messages (e.g. traffic jams) on the screen in the form of icons. Only available with the optional TMC active cradle.



POI icons: Tap this button to have **POI categories** (e.g. petrol stations or hotels) displayed on the screen. When you tap the button, the POI category list is displayed. You can then tap the required category in order to display, for example, the petrol stations on the map. Please also see "POI – "Point of Interest" destination" on page 82.

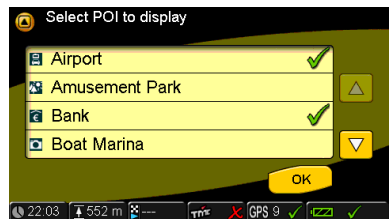

Screen settings



Tap this button to make your preferred screen settings. The selected settings are marked and activated with a green tick.



Colours: You can select various different colours for the background of the screen display. Tap this button and select a colour scheme from the list. All of the menus on the screen are then displayed in the chosen colour scheme.



Night/Day: By activating this button you can switch the display to Night or Day mode. This function is not active when **Automatic brightness** is activated.



Brightness: A submenu opens with a tap controller for day and night brightness. Select the desired value in percentage and confirm with **OK**.



Automatic brightness: If you activate this button, the brightness of the screen is automatically adjusted using the navigation system's light sensors. Manual **Night/Day** switching is deactivated.



Status bar: The status bar is always displayed at the bottom of the screen. In the status bar settings, you can set up to six information types for which you will receive details.

Possible information types:

- Time
- Date
- Arrival time
- Travel time
- Travel distance
- Delay (through traffic congestion, based on TMC messages)
- Speed limit
- Speed
- Altitude
- TMC provider
- Battery status
- GPS status
- *Bluetooth* status

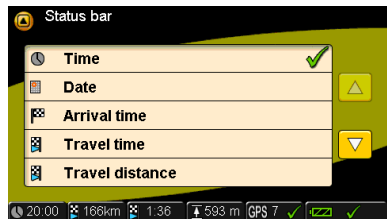

Tap field 1 to field 6 consecutively and select the desired information type from the list that follows.



You can also change the status bar information types directly by tapping the relevant folder in the status bar.

Regional settings



Tap this button to display the regional settings options. The settings are split over two submenus. To open the second submenu, tap the bottom right arrow.



Language: Select your preferred language for the menu and map display. The user interface is displayed in the selected language.



Voice: Selection of preferred voice for guidance information. Select the desired voice for the guidance information.



Units: You can switch between kilometres and miles. Select the preferred unit.



House number position: Locate this at the start or at the end of the address. You can define whether the house number is to appear before or after the street name according to country-specific formats.



Time format: Switch between 12-hour/24-hour time format. Select your preferred time format: 12-hour or 24-hour clock.



Time zone: Select your current time zone. Tap the button to open a list containing the available time zones. The system automatically adjusts to daylight saving time.

Address book



You can save your preferred destinations in your **Address book**. You can select saved addresses as the guidance destination at any time. This menu selection allows you to add new addresses, delete old addresses and import addresses from/export addresses to the SD card.



Add: You can add an address to your address book in four ways: enter the data directly, enter the address of a POI in the vicinity of the location, save the current position or the current destination as the address.



Address: Tap this button to open the Address entry mode.

- Tap on **Country**. Enter the name of the country via the keyboard or view the list of available countries by tapping the **List button**. Scroll up and down the list to select the desired country.



List button: After you have typed a few letters you can tap the **List** button to display a list of matching results. The number of entries that exist under this button is displayed in small digits.

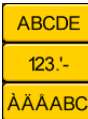

Switch between alphabetical, numerical and accented characters/special characters by using the keyboard toggle.



You can delete incorrect entries by using the "backspace" button (either whole terms or individual letters).

- Tap the **City** entry and type the name of the city you wish to travel to.
- Tap the **Street** entry and type the name of the desired street.
- Then select the house number using the **Number** entry and tap **OK**.



- Saving an address in the address book:** The keyboard is displayed and you can assign your address book entry a unique name. The address is then saved under this name in alphabetical order and can be called up as a navigation destination.



Saving a POI in the address book: Enter the **Country** and **City** in the **Address entry** on the screen. Then tap the **POI** button on the bottom left and the POI categories are displayed. Tap on the desired category and select the desired POI in the vicinity of the selected destination from the selection that follows. Tap the **Add address** button to save the address of the POI in the address book.



Current position: The keyboard appears and you can assign a unique name for your current position. The address is then saved under this name in the address book in alphabetical order. This function is particularly useful if you are in a location that you would like to return to at a later stage.



Current destination: Tap this button to save your current destination in the address book. The keyboard is displayed and you can assign the destination a unique name. The address is then saved under this name in the address book in alphabetical order.



Delete address: Tap this button to delete one or more addresses that you no longer require from the address book. First the list of saved addresses is displayed. Tap the address that you want to delete (scroll through the list using the arrows), a confirmation screen is displayed. Tap on **OK** to delete the address or tap on **Back** to retain the address.

Importing/exporting an address book: You can export your address book to an SD card* and import an SD card into your address book. This means you can easily transfer an address book to a different PN 4000/PN 6000. The export function also allows you to archive a copy of your address book on the SD card. When importing or exporting the address book you have to make sure that an SD card is inserted in the card slot.



Importing an address book: Tap this button to import an address book from the SD card. If the SD card contains an exported address book, this will overwrite the existing address book on the navigation system. Before the existing address book is overwritten, a dialogue box appears in which you must confirm the overwrite.



Exporting an address book: Tap this button to export an address book to the SD card. If the SD card already contains an address book, this will be overwritten by the address book that is being exported. Before the existing address book on the SD card is overwritten, a dialogue box appears in which you must confirm the overwrite.

* "Secure Digital Card" and the "Secure Digital Logo" are legal trademarks of the **SD Card Association**.

Information



Tapping the TMC Info button provides you with traffic information, provided TMC is activated and the navigation device is inserted in the MA3000T/MA3000TB cradle.



Problems on route: Tap this button to open the list of current traffic problems that the TMC provider has registered for your route. Depending on the results, you can have another route calculated.



All notifications: Tap this button to view all the traffic reports notified by the TMC provider.

Sound



Choose this option if you want to change sound settings (e.g. mute, set volume or set button click).



Mute: Tap this button to activate or deactivate the mute option for the navigation voice. The green tick indicates that mute is active. If you want to hear the navigation voice again, simply deactivate mute.



Volume: Tap this button to set the volume of the navigation voice or alerts. A screen then appears that allows you to increase or decrease the volume. Tap the **OK** button to confirm your selection.



Keyboard sound: Tap this button to activate or deactivate the keyboard sounds. The activated keyboard sound is indicated by a green tick.



External speakers only: If you purchased an active cradle and the navigation device is mounted in this cradle, you can activate the external speakers of your connected car audio system. Activating this button turns off the internal navigation system speakers.

Change route – avoid traffic jams



This function effectively helps you to change your planned or current route and avoid other traffic problems. If you are using the optional TMC cradle, you can have a new route calculated that takes into account the traffic information. A corresponding new route is suggested.

If you have also marked the **Full route display** in *Settings > Map display > Display settings*, you will see the full changed route.



You can call up the toolbar via the Dayton logo in the bottom right of any screen, i.e. also during guidance. See "Toolbar" on page 78.



Short detour: This calculates a detour for the next 2-kilometre stretch of the route.



Medium detour: This calculates a detour for the next 7-kilometre stretch of the route.



Long detour: This calculates a detour for the next 15-kilometre stretch of the route.



Recalculate route: This ignores all new manual route calculations such as "Medium detour" and calculates a new route based on the route preferences/options.



Avoid traffic jam: As soon as a traffic block or jam is notified by the TMC provider, you can use this function to recalculate the route by taking into account all the traffic jam notifications received for your route. A dialogue box is opened containing an alternative route with a new travel distance and time. You can either accept or reject the suggestion.

Simulation



This menu allows you to simulate a guidance from any start location to any destination.

Please note that a simulation takes the same amount of time as the actual guidance. In this mode, "Simulation" appears on the screen. The simulation can also be used to plan routes and the travel time from A to B in various different conditions. The results are displayed in the status bar if you choose to display the *Travel time* and *Travel distance*. If you have read the information, e.g. the travel time, you can end the navigation simulation. Unlike with a route planner, there is no need to print anything off; the navigation system will reliably guide you to your destination.

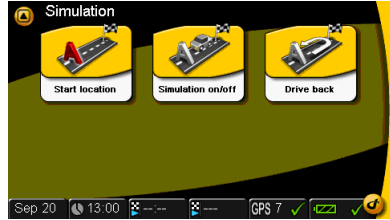

The destination for the simulation can always be selected in *Main menu* via the *Destination*. The destination address can be selected as the first or last step of simulation.



Start location: Tap this button to open the Address entry screen. Enter the desired start address here and end the entry by tapping *OK*. If you have already activated the destination and the simulation mode (see below), simulation is started.



Simulation on/off: Tap this button to activate/deactivate the simulation mode. The green tick indicates that the simulation mode is active. To end the simulation, deactivate simulation mode.

Please note: You also need to end the guidance. To do this, tap the *Stop guidance* button in the toolbar.



Drive back: If you want to run the simulation from the start location to the destination and back again, tap this button. The green tick indicates that the mode is active.

TMC (Traffic Message Channel)



If you are using the optional TMC cradle, you can receive traffic information from the available TMC providers. During guidance, the system regularly accesses the latest TMC traffic information, provided this information is available in the country you are in. A green tick indicates that the TMC mode is active. Please also see "Information" on page 71 and "TMC status and quality (only active TMC cradle)" on page 101.

Alert points displayed on the map



This option provides you with audible and/or visible alerts that you are approaching a speed check or a red light control check when you are travelling (only available in countries where this information can be accessed). You also receive an alert if your actual speed exceeds the prescribed speed limit. Tap this button to make your selection on the next screen.



Tap this button to receive visible alerts on your screen. A green tick indicates the status is active.



Tap this button to receive audible alerts. A green tick indicates the status is active.

Position & speed/Select location



Change position: You can change your position in this menu. Tapping on this screen displays the address entry screen. Enter your desired location.

Select map



The selection of available maps is displayed. If you have installed several individual map products on your SD card you can select these maps for guidance.

System ID



Tap this option to show product and map database versions. This information may be necessary for software updates.

Default settings



This button allows you to completely delete data such as the address book or *Bluetooth* pairing data and, if necessary, reset the factory defaults. These options can be used if you want to pass the navigation system on to someone else without your personal settings or addresses. The device system is returned to the condition in which it was supplied.



Clear addresses: Tap this button to permanently delete all the addresses stored in your address book. A confirmation screen appears for security purposes so you can either confirm or cancel the delete.



Reset to factory settings: Tap this button to reset the system to the factory settings.

Caution: All your personal settings will be permanently deleted! A confirmation screen appears for security purposes so you can either confirm or delete the procedure.



Delete all pairings: Tap this button to delete the list of paired *Bluetooth* devices. Before the list is deleted a confirmation screen appears for security purposes.



Security code settings: Tap this button to protect your navigation system with a password (security code). The following options then allow you to enter a security code or delete the current code. The password is then requested each time the system is restarted. The system cannot be used if the valid password is not entered. The security code may contain letters and/or digits. The maximum length of the security code is 16 digits. Do not use any special characters.



You can use this function to protect the personal data (addresses) that is stored on your navigation device. Make a note of the password and store it in a safe place.



Use this button to delete a defined password.

Bluetooth settings



Bluetooth functions such as handsfree calling and pairing can only be used when the navigation system is placed in the MA3000TB *Bluetooth* cradle. If the navigation system is not placed in the cradle, the *Bluetooth* functions are not available and the *Bluetooth* buttons on the screen are deactivated.

The ***Bluetooth settings*** can also be called up from the Main menu via the ***Multi-media*** button. First tap the ***Multimedia*** button, then the ***Bluetooth*** button. Then tap on ***Bluetooth settings***.



Bluetooth on/off: Tap this button to turn the *Bluetooth* functions on or off. If the *Bluetooth* functions are off, handsfree calling via the navigation system is inactive, even if the navigation system is in the cradle.



Auto connect (on/off): Tap this button to activate/deactivate auto connect. When the navigation system is placed in the *Bluetooth* cradle, the *Bluetooth* cradle can automatically attempt to connect to the most recently connected *Bluetooth* phone. When this phone is in close range, the *Bluetooth* cradle will set up a connection to the phone. Handsfree calling is available when the connection has been established. If Auto connect is deactivated, the most recently used *Bluetooth* phone must be connected manually. To do this, tap the ***Connect*** button in the ***Bluetooth*** menu.



Start pairing: Before the *Bluetooth* cradle can be connected to another *Bluetooth* device, both devices must be paired. Pairing allows further *Bluetooth* devices to access the handsfree calling function of the *Bluetooth* cradle. The *Bluetooth* cradle is displayed as "MA3000TB" on your mobile phone when the mobile phone searches for the *Bluetooth* cradle.

Pairing is started via ***Start pairing***. Pairing ends as soon as pairing is successful or after three minutes if the pairing fails.

Provided the *Bluetooth* cradle is available for pairing, wireless phones with activated *Bluetooth* can search for the handsfree function and set up a connection. For further information on pairing, please read the user guide belonging to your *Bluetooth* phone.



As soon as the *Bluetooth* phone starts to pair, it requests a PIN code. The PIN code for the cradle is **1234**.

Caution: The cradle can remember up to five paired *Bluetooth* devices. If you attempt to pair a sixth device, the pairing data of the least used *Bluetooth* phone is deleted and replaced with the pairing data of the new *Bluetooth* device.



Ringtone volume: When an incoming call is received, a ringtone is played until the call is accepted. Tap this button to open the ringtone screen. Here you can increase or decrease the volume of the ringtone. Tap the **OK** button to confirm your selection.



Delete all pairings: Tap this button to delete the list of paired devices. Before the list is deleted a confirmation screen appears.

Toolbar

The toolbar provides a shortcut to different functions and information (e.g. mute, volume setting, day/night mode, route changes and information).



You can open and close the toolbar by tapping the logo in the bottom right of the screen. The toolbar can be opened on any screen. This fast access is particularly useful during guidance.

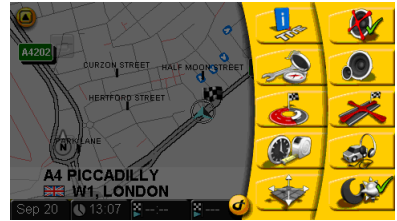

Toolbar functions



The **Information** function, with the TMC-based traffic information display options is opened directly. See "Information" on page 71.



The **Map display > Display settings** submenu with the guidance display settings is opened directly. See "Display settings" on page 65.



The **Change route** function, with detour options for traffic jams is opened directly. This also offers direct access to the **Recalculate route** function. See "Change route – avoid traffic jams" on page 72.



The **Set route profile** function with route profile settings and route planning options is opened directly. See "Set route criteria/route profile" on page 79.



The **Crosshairs** allow you to change the destination manually and implement this change.



Direct access to the navigation system's **Mute** option. See "Sound" on page 71.



Direct access to the navigation system's **volume control**. See "Sound" on page 71.



Direct access to **Cancel guidance. Guidance is terminated**. See "Stopping guidance" on page 82.



Direct access to **Route & Sound**. The music player is opened. See "Multimedia menu" on page 85. You can now use the music player functions to listen to your desired track. Playback will be interrupted by the voice alerts for guidance. This means you can easily switch to guidance from the music player.



Direct access to **Day/Night mode** of the screen display. See "Screen settings" on page 67.

Set route criteria/route profile



The **Toolbar** allows you to select the latest **Route criteria** that you require. You can activate various route options independently of the selected route criteria in order to set the route calculations for your particular needs. A suitable route is calculated based on your preferences. You can choose from the following modes:

Options



Avoid motorways



Avoid ferries



Avoid tunnels



Avoid toll roads



Avoid toll gates



Consider traffic info

Preferences



Fast



Short



Economic

Navigation

The purpose of the navigation system is to guide you from your present location to your desired destination. The navigation system automatically determines your present location using the GPS signal. All you have to do is enter your destination and the guidance process starts with spoken and visual instructions.

Entering a destination



Enter destination: Tap this button to enter or select the destination.



The **Home** and **Work** destinations that can be predefined can be accessed from the Main menu for your convenience. Simply tap the **Home** or **Work** button on the screen to be guided to these destinations. (See "Adding to the address book" on page 83.)



For your destination you can:

- Enter any address directly
- Select a saved address from your address book
- Select one of your last destinations
- Select a special destination (**POI**), e.g. a restaurant or a garage

You can also add geographical coordinates as your destination. This can be useful if you want to go to a destination for which there is no address data. After selecting your destination the guidance starts immediately. You can change the address in the **Address book** to **Home** or **Work** at any time on the navigation screen.



Address – Entering the destination directly



Tap this button to open the **Address entry**.

- **Country:** Tap this button to select the country in the following screen.
- **City:** Tap this button to select the name of a city or location in the following screen.
- **Street:** Tap this button to enter or select street names in the following screen. Finally choose the house number and tap **OK**.





This button allows you to switch between entering a house number or a crossing. Instead of entering a house number, you can select to enter a crossing, e.g. instead of *15 Oxford Street, London*, you can enter the crossroad *Oxford Street/Regent Street, London*.



Tapping this button allows you to call up special destinations in the vicinity of the entered address (POIs) (e.g. restaurants, hotels, petrol stations, car dealerships) and the desired object as the destination.



Intelligent character input: The navigation system is equipped with intelligent character input that only displays the permitted characters.



List button: After you have typed a few letters you can tap the **List** button to display a list of matching results. The number of entries that exist under this button is displayed in small digits.

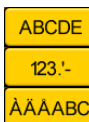

Switch between alphabetical, numerical and accented characters/special characters by using the keyboard toggle.



You can delete incorrect entries by using the "backspace" button (either whole terms or individual letters).



While you are on route you can always set a new address. The navigation system recalculates the route and the guidance continues.

Address book – Selecting an address



Tap this button to call up a saved address from the list. Tap the address you require to select it, the guidance is then started.



To add, edit and delete addresses, tap **Address book** in **Settings**. Please also see "Address book" on page 69.

Selecting the previous destinations – History



Tap this button to display the list of previously selected destination addresses. Scroll through the list with the arrow button and then select an address that you would like to re-use as your destination.

Geographical coordinates destination



Coordinates: Tap this button to display the geo-coordinates of your current location. Tapping the individual coordinates allows you to enter the destination coordinates. When entering geographic coordinates, you must also select the northern or southern hemisphere through the globe in the bottom right of the screen. The coordinates are given in "degrees/minute/second".

POI – "Point of Interest" destination

POIs (Points of Interest) are special destinations or locations of interest such as restaurants, petrol stations etc., the addresses of which are saved in the corresponding navigation system categories.



POI: If you want to select a POI as the navigation destination, tap this button to call up a further selection. In the following screen, define where you require this destination: near the current *position* or near the *destination*.



Near position: Tap this button to search for a POI near your current position.

Example: You want to find a hotel near your current position. Tapping the **POI** button opens the POI menu. Tap the **Near position** button. The navigation system shows you a list with all available POI categories. If you select **Hotel**, the navigation system will list all the known hotels in the area. The hotel nearest to your current position will be at the top of the list. Tap on the desired hotel. You have now selected the hotel as the destination. The route will now be calculated automatically and displayed on the map. To start the guidance, tap on **OK** in the confirmation screen that appears.



Near destination: Tap this button to search for a POI near your destination.

Stopping guidance



Stop guidance: Tap this button to stop the current guidance. This also applies for guidance in simulation mode.

Guidance – Confirming a destination

When you have entered the destination, all elements for the desired destination appear on the Confirmation screen; the system will confirm your selection.



The **Crosshairs** button allows you to vary the destination manually. Tap on the desired location in the map display and "drag" below the crosshairs with your finger. The new position is transferred. See also "Toolbar" on page 78.



Add to address book: Tap this button to add the current address to your address book or to assign it to **Home** or **Work** for fast access.



Route criteria: Tap this button to select certain profiles and options in the following screen. The available profiles and options are explained under "Set route criteria/route profile" on page 79.

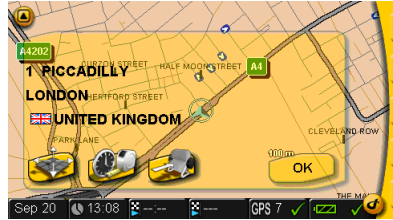

Tap **OK** on the screen or wait a moment: the **Map display** screen will automatically appear. Guidance begins with visual and audible alerts.



Each destination is automatically saved in the **Previous destinations** category (**History**).



Guidance – Map display

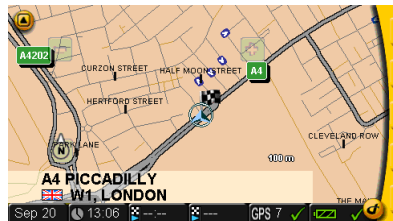

When you have set your destination the route will automatically be calculated and displayed on the map. You can now start driving and the navigation system will guide you to your specified destination.

Tapping the **Map display** button in the **Main menu** takes you directly to the map display.



Zooming in/out of the map display (zoom function)

The  and  buttons allow you to adjust the scale of the displayed map. These buttons are not displayed if the **Full route display** is activated. When **Auto scale** is activated, the screen reverts back to the original zoom level a set time after a manual zoom change is made with the +/- buttons.

- If you want to zoom out of the map, tap the  button until you reach the desired zoom level.
- If you wish to zoom in on the map, tap the  button until you reach the desired zoom level.



Compass: By repeatedly tapping on the compass you can either orientate the map northwards, have the display follow the direction of travel in all directions, or show the 3D display.

Route bar



The transparent column right on the map gives visible instructions (e.g. a dotted arrow means "Follow the road ahead"). You can activate and deactivate the instructions and information via the **Settings** menu in the **Map display** submenu. You can select the following information for display in the route bar:

- Visual advice
- Lane guidance
- Destination arrow

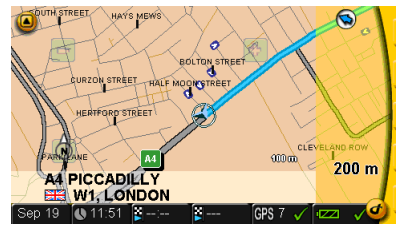

Multimedia menu



The navigation system offers the possibility of playing MP3 files, viewing JPEG images or playing games. To use these multimedia functions, the MP3 or JPEG files in question must be saved on an SD card.



If you have an SD card reader/writer, you can copy your MP3 files and JPG pictures directly from your PC to the SD card.



If you use Microsoft® Windows® Media Player to copy files you can enter complementary information for each MP3 file. You can assign the files to an **Album**, an **Artist** or a **Genre**. You can also create your individual **Playlist** of favourite tracks. The MP3 player supports this categorisation and enables an easy selection of tracks. Please note that the **My_playlist.wpl** must be saved in the same directory as the tracks it contains.

If you save your MP3 files without this additional information, the files will simply be displayed in the alphabetical order in the **Current playlist**.

The JPEG viewer offers you an easy-to-use browser to help you choose pictures using folders. Therefore, if you save your pictures in separate folders, you can use the **Browser** to select the desired images.

Insert the SD card in the slot on the left side of the device.

- Tap the **Multimedia** button in the main selection screen.
- The multimedia selection menu appears.

Music playback



Tap the **Music Player** button.

On the screen you see the list of all titles in the alphabetical order **Current playlist**.

You can select a title directly by tapping the requested title.

- Tap the up arrow (top right) to scroll up through this folder and all other folders.
- Tap the down arrow (bottom right) to scroll down through this folder and all other folders.



You return to the main menu by tapping the left up arrow. Playing will stop.



Tap the **Navigation** button (bottom right) to return to the navigation application (**Route & Sound**). Playback will not be stopped.

When you tap on the desired track, the following is displayed:

- Title of the current track
- Full playback time in the top bar and
- Time that has already elapsed in the bottom bar.

By tapping the symbols on the left you can perform the following functions:

- 1 Jump to next title
- 2 **Start** playing, or **pause** during playing
- 3 Switch to the selection menu (**Menu**). Here you can choose titles according to the criteria: the **Album**, the **Artist**, etc.
- 4 **Stop**
- 5 Jump to previous title
- 6 Volume control

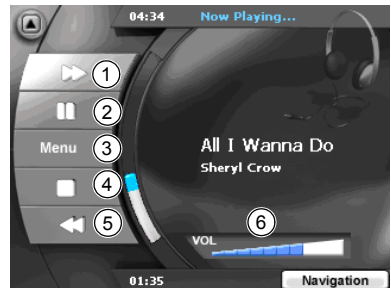

Selection menu

Tapping the icons on the left in the **Menu** allows you to perform the following functions:

Album Switch to the list and the album selection.

Artist Switch to the list and the artist selection.

Genre Switch to the list and the genre selection.

Playlist Switch to your individual playlist selection.

Song Switch to the alphabetical list of all tracks and the desired tracks selection.



Repeat Turn repeat play function off (**Repeat off**), repeat the last title (**Repeat track**), repeat all titles (**Repeat all**). This function refers to the current setting of the list (**Album, Artist, Genre, or Playlist**). During the **Song** setting (the list of titles in the alphabetical order) this function refers to all titles.

Shuffle Activate/deactivate random playback order. This function also relates to the current selection (**Album, Artist, Genre or Playlist**). During the **Song** setting (the list of titles in the alphabetical order) this function refers to all titles.



VOL Tapping the volume scale controls the volume.



You return to the main menu by tapping the left up arrow.

Picture viewer



Tap the **Picture viewer** button.

- On the screen, you will see the picture and the number of the picture in the upper bar within the corresponding folder.

Tapping the icons on the left in the selection menu allows you to perform the following functions:

Slide Start slide show

>> **File** Jump to next picture

<< **File** Jump to previous picture

>> **Folder** Switch to next folder

<< **Folder** Switch to previous folder

Browser Tap the Browser button to open a file browser where you can choose your pictures



You return to the main menu by tapping the left up arrow.

Tap on the picture to display the image in full screen mode. You will return to the small picture by tapping the large picture. In full screen mode, you can carry out the following functions by tapping the corresponding arrows:

- 1 Jump to next picture
- 2 Jump to previous picture
- 3 Switch to next folder
- 4 Switch to previous folder



Browser – Selecting Pictures from Folders

- In the Main selection screen, tap on **Browser**.
- The folder selection screen appears.
- Tap the up arrow (top right) to scroll up through this folder and all other folders.
- Tap the down arrow (bottom right) to scroll down through this folder and all other folders.



You return to the main menu by tapping the left up arrow.

- Tap on the desired folder in the browser screen. The picture selection screen appears.
- Tap the name of the desired picture in the browser screen. The picture is displayed.

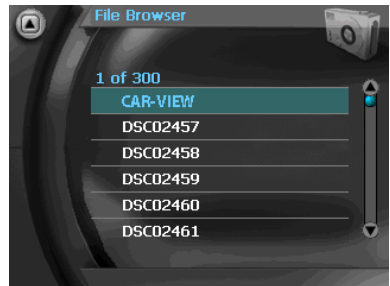



Games

Open the game selection list by tapping this button.



Video player

Tapping this button allows you to play back WMV files (WMV simple profile) that have been synchronised on the navigation system with the Microsoft® Windows® Media Player® **MTP protocol**. For further information on using MTP protocol, please see Microsoft® Windows® Media Player® Help.



Bluetooth

Tapping the **Bluetooth** button in the **Multimedia** menu opens **Bluetooth** functions such as connection setup and handsfree calling.



Connect: Your paired **Bluetooth** phone can be connected to the MA3000TB cradle via its **Connect** function. For further information on pairing, please read the user guide belonging to your **Bluetooth** phone.

While the navigation device is being connected to the previously connected **Bluetooth** phone, the **Connection is in progress** icon is displayed in the **Bluetooth status bar**.

As soon as the first connection is established, the cradle will automatically establish a call to this phone when the Auto connect function is activated.



Please note: The previously connected **Bluetooth** phone can also be automatically connected when the navigation system is placed in the **Bluetooth** cradle and Auto connect is activated. This setting is available in the **Bluetooth settings** menu.

If you would like to connect another paired **Bluetooth** phone with the cradle, please use the Connect function on your phone. A connection can only be established if the phone and the cradle have already been paired and no other phone is connected to the cradle.



Disconnect: Tap this button to disconnect the **Bluetooth** phone from the navigation device. To establish a new connection, tap the **Connect** button or set up a new connection via another paired **Bluetooth** phone.

Callback/Redial



Tap this button to call the last phone number to have been dialled.



The redial function may vary depending on your phone.

Handsfree calling

Accepting an incoming call: When a *Bluetooth* phone is connected to a *Bluetooth* cradle a dialogue box appears as soon as the call is received. If the caller's phone number is transferred, this is displayed in the dialogue box.



Tap the **Accept** button in the dialogue box to accept the call. To reject the call, tap the **Decline** button in the dialogue box.

During a phone call a dialog box with the following buttons is displayed:



End call

Toggle between *Handsfree calling* and *Private* mode:



In *Handsfree calling* mode, the microphone and the loudspeaker of the *Bluetooth* cradle are activated.



In *Private* mode, the internal microphone and the internal loudspeaker of the *Bluetooth* phone are activated. This mode allows you to make a confidential call.









This button allows you to control the volume during a call.



Closes or opens the dialogue box. This button is displayed in the top right of the screen for the duration of the call.

Bluetooth status bar

Display Bluetooth status bar icons: You can display the *Bluetooth* status in the status bar by selecting *Settings > Screen settings > Status bar > Status bar settings* in one of the fields. Depending on the current status, various icons can be displayed:

Icon	Description
	<i>Bluetooth</i> functionality disabled.
	Device not placed in the <i>Bluetooth</i> cradle.
	Device is placed in the <i>Bluetooth</i> cradle.
	The <i>Bluetooth</i> cradle is ready to be paired.
	Auto connect is in progress.
	Phone connection is active.

Bluetooth settings



The *Bluetooth settings* can also be accessed via the *Settings* menu described on page 76.

Further information on Bluetooth

Power supply

The *Bluetooth* cradle can be powered via the navigation system's internal battery to maximise the user's mobility. When *Bluetooth* is activated, the operating time of the navigation system is reduced due to *Bluetooth* power consumption. We recommend that you power the *Bluetooth* cradle with an external power supply.

Microphone position

The microphone should be positioned as closely as possible to the user, but the user should not speak directly into the microphone (the microphone should ideally be pointing away). For the best audio quality (with less echo), it may be necessary to change the position of the navigation system or the microphone.

Please note: The *Bluetooth* trademark and logo are the property of *Bluetooth* SIG, Inc. and use of this trademark and logo is licensed by VDO Dayton. Other brand logos and brand names are the property of the respective owners.

DVB-T digital television

You can use your PN 4000/6000 to receive television programmes via DVB-T (Digital Video Broadcasting Terrestrial).



There may not be as many channels available as there are on your home set, and the DVB-T standard is not available in all countries. The reception quality also depends on a number of factors, e.g.:

- The number of transmitters, their distance and their power
- The speed and direction in which your vehicle is moving.

Other factors that may impair reception quality include:

- Operation while the vehicle is moving, e.g. through built-up areas
- Weak signal when overshadowed by other vehicles, travelling through under-passes etc.



For DVB-T reception, connect at least one (for a better reception connect both) of the DVB-T aerials supplied with the PN 4000/6000. Remove the rubber cover on the rear of the device at the top right and plug in the aerial. If you are using both aerials, the two should be positioned at least 50 cm apart in order to ensure the best possible reception.

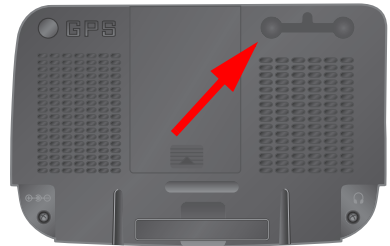

DVB-T picture reception is deactivated when the vehicle is travelling, unless the special VDO Dayton headrest adaptors are used. DVB-T sound reception and navigational information continue to be available.



To switch on the television, tap the **DVBT** button in the **Multimedia** menu.



The television screen will be displayed with the buttons for operating the television receiver.

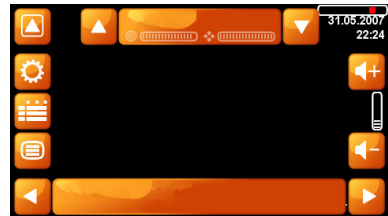

Tap the **Back** button again to exit the DVB-T mode and return to guidance or to exit a submenu and return back to the previous menu.

Scanning for and selecting a channel



Access the scanning and channel selection functions by tapping the *Channels bar* at the top of the screen.

Tap the *Channels bar* to open the relevant sub-menu.



Tap the *Scanning channels* button to start scanning.

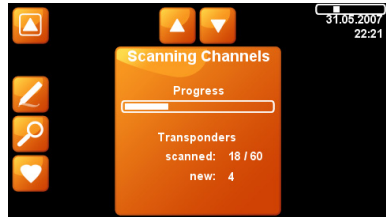

Once the search has ended, the list of channels found will be displayed. Tap the required channel to view the current programme.



You can now scroll between the programmes using the up/down *arrow buttons* on both sides of the Channels bar.



Operation and control

The motion bar in the top right of the screen above the date and time indicates that the device is scanning for channels.



The button below the date and time allows you to adjust the volume.

Tap the [+] button to increase the volume and the [-] to decrease the volume.

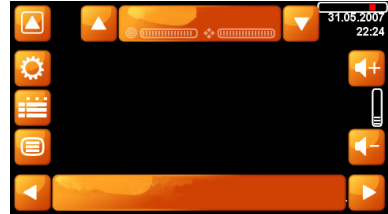

If a channel is found, the Channel bar at the top of the screen displays the name of the channel that is found, e.g. "VOX". Below the channel name, the signal strength or reception quality is displayed.



You can use the **Up** (left) and **Down** (right) arrow buttons around the channel name to scroll up and down through your saved channel list to select the channel you require.



The programme bar at the bottom of the screen displays the name of the current programme and the start and end times (= start of the next program).

The **Back** (left) and **Forward** (right) buttons allow you to scroll backwards and forwards through the programme listings for the chosen channel. This does not change the channel. The channel is only changed once you tap on the listed programme.



The buttons on the left of the screen allow you to call up the following submenus:



System settings

Tapping the **Settings** button allows you to make various system settings.



Channel and programme selection (EPG)

The **EPG** button allows you to change the channel and the programme. This displays an overview of channels and current programmes.



Teletext

When a channel is active you can also view the teletext pages for that channel. Tap the **Teletext** button. To open a Teletext page, tap on the screen to call up the numbers keyboard. Enter the required page number on the screen to bring up the page.



To switch to full screen mode, tap on the screen to hide the controls. Tap on the screen again to show the controls.



Tapping on the **Back** button in the top left takes you back to the previous menu.

Settings

The **Settings** submenu allows you to make the following basic settings.

- Audio
- Video
- Subtitles
- System



Tap the **Audio** button to select the language of the channel selection, e.g. *English* for English language channels. Tap the **Back** button in the top left of the screen to return to the **Settings** menu.



Tapping the **Video** button takes you to the picture settings. First you can select the desired screen format.

To automatically adjust the format to the size of the screen, tap the **Auto** button.

To select the 4:3 format, tap on this button.

Select **Zoom** to enlarge the picture and adjust it to the screen size.

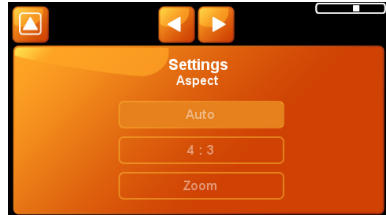

Tap the **Arrow** button in the top of the screen bar to set the **Brightness** and **Colour** of the picture. Tap the [+]
button to increase the intensity and the [-]
button to decrease it.

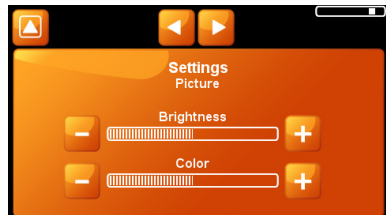

Tap the **Subtitle** button to make the corresponding settings. Tap the **Auto** button to automatically display subtitles (where available) in the language selected in Audio settings.

Some channels broadcast programmes that offer foreign language subtitles, e.g. German. If this is the case for any of the active channels, the available languages are displayed in the language selection. Tap **Language** to make your selection.

To stop subtitles being displayed, tap **Off**.

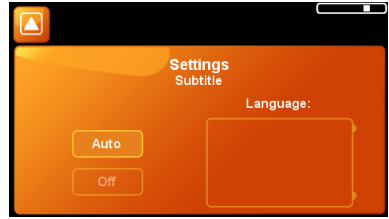

Tap the **System** button to make the **System settings**.

Tap the **Mobile** button to watch television while travelling, tap **Stationary** to only watch television when stopped.

Auto Scan Delay allows you to state after how many seconds a new search should be run after the current channel signal becomes too weak. The default value is 10 seconds.

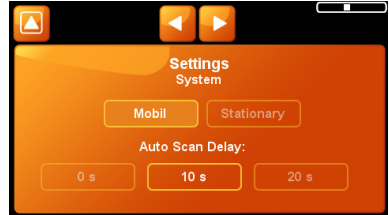

Tap on **Next** at the top of the screen if you want to reset the device to the DVBT receiver's factory settings.

Tapping the **Reset Reception Data** button will clear all saved channel and programme data. If you tap on the **Back** button in the top left of the screen after clearing the data, the device automatically starts scanning for channels again and the new data is saved.

This is recommended if you often use the television when travelling.

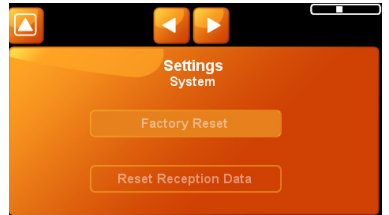

Saving favourite channels



Tap the **Display** button to display all the channels that have been found so you can make your selection.

The list on the left shows all detected channels, and your favourite channels are listed on the right.



To add a channel to your list of favourites, first tap on the channel name you want to save and then on the **Add** button.



To remove a channel from your list of favourites, first tap the desired channel name and then tap **Remove**.



If you want to delete a channel from the full channel list, tap on the channel you want to delete and then on the **Delete** button.



Tapping the **Forward** and **Back** buttons (top of the screen) allows you to toggle between the two bars.



You can scroll through the lists using the **Scroll up** and **Scroll down** buttons (top of the screen).



The **Move up** and **Move down position** buttons allow you to define the list order of the saved channels.



Tap the **Heart** button to call up your preferred channel or tap the **Globe** to open the list of all the channels. You can then select your favourite channel.



Channel and programme selection – Electronic Program Guide (EPG)

The DVBT module of your PN 4000/6000 uses electronic programme guidance to make programme selection very easy and convenient for you.



In the main screen, tap on **Channel and programme selection (EPG)** to display the overview of the channels and the current programmes.



The channel name is displayed on the left and the corresponding programme is displayed next to it on the right. The programmes for the current date and time are displayed.

Tap the programme you want to watch. As long as the programme is currently being broadcast, you can watch it.



The **Scroll up** and **Scroll down** buttons allow you to scroll through the programme overviews for the different channels.



Tap the **Forward** and **Back** buttons to scroll forwards and backwards through the programme overview.



By making the programme overview smaller, you can view the descriptions of several programmes. Tap on the **Reduce** button.



By making the programme overview larger, you view fewer programme descriptions. Tap on the **Enlarge** button.

If you want to view information on a programme, tap on the programme. A screen then opens containing information on the programme content.

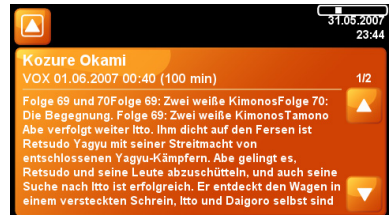

Tap the **Back** button (top left) twice to return to the television screen.

Teletext

When a channel is active you can also view the teletext pages for that channel.



In the main screen, tap the **Teletext** button to open the teletext ("Start page 100") for the current channel.



The buttons on the left of the screen allow you to:



Scroll up through the teletext pages in ascending order.
Scroll down through previous teletext pages in descending order.



Scroll to the next subpage on teletext pages with subpage(s).



Scroll to the previous subpage on teletext pages with subpage(s).

If you want to go straight to a particular teletext page, tap the screen to call up the numbers keypad. Enter the required page number on the screen to bring up the page.



The numbers keypad contains the following buttons:



Enlarge font



Display background as *cover* (for easy reading) or *transparent* (to continue viewing the channel).



Tap the **Back** button (top left) to return to the previous menu.

GPS status and quality

When you switch on the device for the first time, it may take several minutes for the GPS reception to reach a sufficient level and to determine your current position. If you are unable to obtain a sufficient GPS signal, please read the "Troubleshooting" chapter for suggestions on solving the problem.



The GPS aerial is located below the top side of the device. For this reason, try to hold the navigation device in an upright position for the best possible GPS reception.



If you are using the navigation system in an inner-city area, it may take longer to refresh the map items on screen. This is due to the large number of roads and additional information (e.g. hotels, restaurants) as well as the high density of buildings. Furthermore it may take longer to establish the GPS reception if you have just driven out of an underground car park or another type of building where GPS signals are blocked.

The GPS reception can be checked by doing the following



Check the *GPS status* in the status bar.

If the status bar does not show the GPS status: Tap on a status bar element and select *GPS status* from the list.

The number of tracked GPS satellites is shown. The quality of the GPS signal is indicated by the shape and colour of the tick:

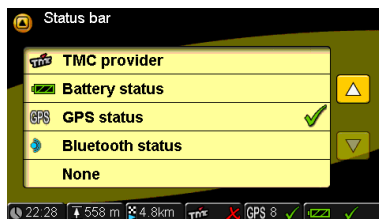

Red

No reception

Yellow

Initialising or insufficient signal quality, fewer than 3 satellites have been found

Yellow

Sufficient signal quality, but not very accurate position

Green

Good signal quality, precise position, guidance possible

TMC status and quality (only active TMC cradle)



The TMC device offers you the additional function of dynamically avoiding traffic jams. During navigation, the system regularly accesses the latest TMC traffic information, provided this information is available in the country you are in.



TMC information is displayed in the status bar.



Tap **Settings**, then **TMC** to switch TMC reception on or off.



Traffic information depends on several conditions, e.g. the TMC device is switched on, traffic information must be available and broadcast by the provider. The quality and accuracy of the messages depends on the provider. The navigation device has no influence over the available data.

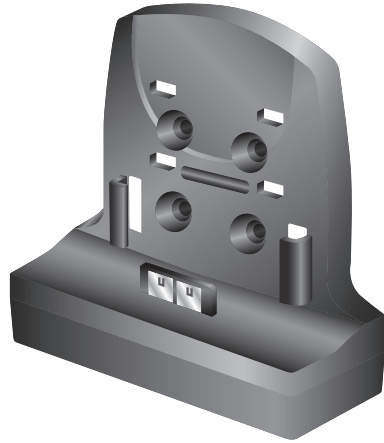

If the TMC is switched on but there is no reception, a yellow tick is displayed. During TMC reception, the name of the provider or a green tick is displayed in the status bar. If the TMC is switched off, a red cross is displayed instead of a tick or a provider.



If the TMC is switched on and you are receiving travel information, expected delays are displayed in the status bar (e.g. due to a traffic jam or road works). The delay is indicated by the colour of the hourglass:

Red TMC reception OK; delay on selected route

Green TMC reception OK; no delays

Grey TMC unavailable or switched off



If the TMC is switched on and there is a traffic jam on your route, a corresponding icon appears on the left in the map display screen. Tap this icon and a list of detailed information appears.

Troubleshooting

Problem	Solution
No GPS signal in vehicle	The GPS signal can be blocked by heated wind-screens or tinted windscreens with a vacuum-metallised coating. In this case, you will need an external GPS aerial (available from accessory dealers, article no. MA2010/00).
No GPS signal	Ensure that the GPS aerial on the top of the navigation system is not obstructed by other objects.
GPS signal poor	Attempt to adjust the navigation system.
The navigation system no longer responds to finger taps or does not switch off	If the navigation system stops responding to your entries, you can press the reset button on the underside of the device (e.g. with a straightened-out paper clip or a pencil). The data you have saved will NOT be lost! Restart the navigation system by pressing the power button.
System fails to start, screen remains blank	Ensure that the battery is fully charged and/or that the device is connected to a power source. If you are using the DC cable, check that the plug is securely and correctly connected to the cigarette lighter.
The system shuts down automatically after a certain amount of time	In extremely low or high temperatures, the system will temporarily shut down to prevent it from being damaged. A sudden shutdown is also possible when the battery is empty.
The voice alerts for navigation cannot be heard	Check whether the volume is set to an audible level in the basic settings.
Navigation is not accurate	An inaccuracy level of 50 m is within acceptable limits. If an inaccuracy level occurs repeatedly, please contact an authorised specialised dealer.
Driving/navigation instructions do not correspond to the actual traffic situation	The position currently determined by the navigation system may be incorrect. Traffic routing may have changed and does not correspond to the information on the map.
No sound	The device may be set to mute, or the volume is set too low.

Technical Data

PN 4000

- 4.3" colour TFT LCD with 480 x 272 pixel resolution, 16:9 screen, touchscreen, anti-reflex surface
- 372 MHz processor
- 64 MB Flash ROM and 128 MB SD RAM
- 30 channel GPS receiver
- Lithium ion battery with 2200 mAh capacity
- Dimensions: approx. 125 mm width x 83 mm height x 24 mm depth
- Weight: approx. 260 g
- Operating temperature: -20°C to +60°C
- Charging temperature for lithium ion battery: 0°C to +45°C
- Supports SD cards up to 2 GB

PN 6000

- 5.6" colour TFT LCD with 480 x 234 pixel resolution, 16:09 screen, touchscreen, anti-reflex surface
- 372 MHz processor
- 64 MB Flash ROM and 128 MB SD RAM
- 30 channel GPS receiver
- Lithium ion battery with 4000 mAh capacity
- Dimensions: approx. 152 mm width x 97 mm height x 25 mm depth
- Weight: approx. 425 g
- Operating temperature: -20°C to +60°C
- Charging temperature for lithium ion battery: 0°C to +45°C
- Supports SD cards up to 2 GB

Legal notice

© 2007 Siemens VDO Trading GmbH

All rights reserved. These operating instructions are protected by copyright. Subject to technical and layout modifications, and printing errors.

The information contained in this document is subject to change at any time without prior notification. Siemens VDO Trading GmbH reserves the right to modify or improve its products and modify the content without being obliged to inform any particular persons or organisations. The device specifications and package content may deviate from what is stated in this document.

Service

For current information on VDO Dayton Multimedia Systems, service addresses and software updates please visit our website:

www.vdodayton.com

or contact a VDO Dayton dealer.

Subject to technical modifications and errors.

PN 4000/6000

© 11/2007 Siemens VDO Trading GmbH