



MS 3200

Owner's manual and mounting instruction
Mode d'emploi et manuel d'installation
Bedienungs- und Einbauanleitung
Gebruiksaanwijzing en inbouwhandleiding
Istruzioni d'uso e d'installazione
Instrucciones de manejo y de montaje
Bruksanvisning och monteringsanvisning
Betjeningsvejledning og monteringsanvisning

English

Français

Deutsch

Nederlands

Italiano

Español

Svenska

Dansk

USA

Attention!

Only use this system when it is safe to do so. It is more important to keep your eyes on the road and your hands on the wheel.

Due to constantly changing traffic conditions, we unfortunately cannot guarantee 100 % precision under all circumstances.

Attention !

N'utilisez le système que si vous ne mettez pas en danger votre vie ou celle des autres usagers de la route. Il est plus important de surveiller le trafic routier et d'avoir les mains sur le volant que de lire les informations apparaissant sur l'écran.

Étant donné que le sens de circulation a pu être changé entre temps, nous ne pouvons pas vous garantir une exactitude à 100 % des indications données.

Achtung!

Benutzen Sie das System nur, wenn die Sicherheit es zuläßt. Es ist wichtiger, auf den Verkehr zu achten und die Hände am Lenkrad zu lassen.

Aufgrund sich ständig ändernder Verkehrsführungen kann leider keine 100 %ige Genauigkeit unter allen Umständen gewährleistet werden.

Belangrijk!

Gebruik het systeem uitsluitend, als de veiligheid het toelaat. Het is belangrijker om op het verkeer te letten en de handen aan het stuur te houden.

Op grond van voortdurend veranderende verkeerssituaties kan helaas geen 100 % nauwkeurigheid onder alle omstandigheden worden gegarandeerd.

Attenzione!

Usare questo sistema solo se il traffico lo ammette. E' importante tenere d'occhio la strada e le mani sul volante.

A causa dei cambiamenti continui della viabilità non si può garantire una precisione assoluta in tutte le circostanze.

¡Atención!

Utilice el sistema sólo si lo permite el nivel de seguridad. Es más importante atender al tráfico y mantener las manos en el volante.

Debido a que las rutas cambian constantemente, lamentamos no poder garantizar un 100 % de exactitud en cualquier ocasión.

Observera!

Använd systemet bara när säkerheten tillåter. Det är viktigare att iaktta vad som händer i trafiken och hålla händerna på ratten.

På grund av den ständigt förändrade trafiksituationen kan ingen garanti för 100%:ig noggrannhet under alla omständigheter lämnas.

Viktigt!

Brug systemet kun, når De ikke bringer andre eller sig selv i fare. Vær opmærksom på trafikken, og hold hænderne på rattet.

Pga. løbende ændringer i vejnettet kan der ikke opnås 100% overensstemmelse mellem det digitale vejkort og den aktuelle trafiksituation.



Operating instructions Page 7
Mounting instructions Page 49
Illustrations Pages 3, 456 - 457

English

Mode d'emploi Page 57
Instructions de montage Page 99
Illustrations Pages 3, 456 - 457

Français

Bedienungsanleitung Seite 107
Einbauanleitung Seite 149
Abbildungen Seiten 3, 456 - 457

Deutsch

Gebruiksaanwijzing Pagina 157
Inbouwaanwijzing Pagina 199
Afbeeldingen Pagina's 3, 456 - 457

Nederlands

Istruzioni d'uso Pagina 207
Istruzioni per il montaggio Pagina 249
Figure Page 3, 456 - 457

Italiano

Instrucciones de manejo Página 257
Manual de instalación Página 299
Ilustraciones Páginas 3, 456 - 457

Español

Bruksanvisning Sidan 307
Monteringsanvisning Sidan 349
Bilder Sidorna 3, 456 - 457

Svenska

Betjeningsvejledning Side 357
Monteringsvejledning Side 399
Illustrationer Sider 3, 456 - 457

Dansk

Operating instructions Page 407
Mounting instructions Page 447
Illustrations Pages 3, 456 - 457

USA

System Overview	8
GENERAL INFORMATION	9
Tips on the use of this manual	9
ATTENTION! Important notes for safe usage.	9
How does the navigation system work?	10
The digital road map	11
C-IQ – INTELLIGENT CONTENT ON DEMAND	12
C-IQ – Your key to map, traffic and travel information	12
OPERATION	15
LCD Monitor	15
Remote control	15
Switching on / off.	16
Stand-by mode	16
Volume	16
MENUS	17
Cursor	17
Scroll bars	17
Character input	17
Main control menu	19
DESTINATION INPUT	20
Entering a destination address.	20
Destination input menu	20
Special destinations (POIs)	23
Destination input via GPS coordinates.	24
VIAPOINTS	25
Via point input	25
GUIDANCE	27
Guidance screen	27
Audible messages.	28
Route selection	30
Information during guidance	31
TRAFFIC INFORMATION	33
Traffic information	33
DYNAMIC GUIDANCE WITH TMC	35
How TMC traffic announcements are made.	35
TMC traffic information on the guidance screen	35
Bypassing a traffic obstruction locally.	36
Dynamic route planning	36
ALTERNATIVE ROUTE	37
Alternative Route.	37
ADDRESS MANAGER	38
Address Manager	38
EMERGENCY	40
Emergency menu	40



CONTENTS

SYSTEM SETTINGS	41
Speed	41
Guidance screen	42
Dyn. route sett.	42
Language	43
Volume	43
Date / Clock	43
Display	44
Remote control	44
Measuring units.	44
Mounting angle.	44
Default settings	44
Service	44
System information.	44
MAP CDs	45
Map CDs.	45
Changing the map CD	45
MAINTENANCE & CARE	46
Replacing batteries of the remote control	46
Cleaning of the remote control and the monitor.	46
Loading software updates	46
TROUBLESHOOTING.	47
MOUNTING INSTRUCTIONS.	49

System Overview

On page 3 (foldout page) you can find an overview over the system components.





- ❶ Detachable LCD monitor.

 **To remove the monitor, it is essential to press the unlocking button ❷ on the rear of the monitor holder.**

- ❷ Unlocking button for monitor (concealed on the rear of the monitor connector).
Press release button on the back of the monitor support and gently pull upwards to detach.
- ❸ Monitor support, turnable and tiltable.
Press button on the support to tilt the monitor
- ❹ Infrared remote control
- ❺ Holder for remote control.
- ❻ Eject CD. If ignition is switched off press key twice.

Tips on the use of this manual

To make reading this manual easier you are given the following aids:

-  Prompts you to do something.
-  Shows you the reaction of the set.
-  Provides additional information.
 - Marks an enumeration.
-  Shows that the current topic is continued on the following page.

 **This is a security or warning advice. It contains important information on the safe use of your navigation system. In case of disregard of this advice the danger of material damage, injury or even death may result. Please observe this advice carefully.**

ATTENTION!

Important notes for safe usage

 **The usage of the navigation system does not exempt the driver from his responsibilities. Pay attention to the local traffic regulations. Watching the road is more important than watching the display!**

 **If the current traffic situation and the advice of the navigation system are in contradiction, traffic regulations always have priority over advice given by the system.**

 **For driving safety data entries should only be made when the car is stationary.**

 **In some areas it is possible that not all road information is covered. Restrictions regarding entry into pedestrian precincts, driving direction of a one way street and turning restrictions are not given. In these areas the navigation system gives a warning. Always obey road signs and traffic regulations.**

How does the navigation system work?

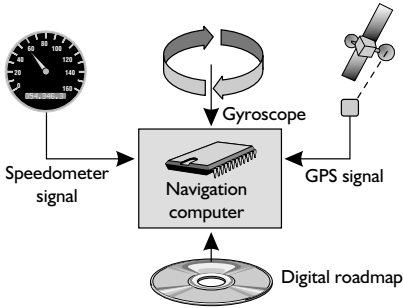

The position and movements of the vehicle are recorded by the navigation system's sensors. The distance travelled is determined by the vehicle speedometer signal, rotary motion in curves is detected by a gyro sensor (inertial compass). The position is determined via the GPS (Global Positioning System) satellites.

The position can be calculated within a range of approx. 10 m by comparing the sensor signals with the digital map on the navigation CD.

Important notes on the function of your navigation system

In principle, the system is functional with poor GPS reception, although the accuracy of the positioning may be impaired by poor or interrupted GPS reception or errors can occur in the determination of the position, which result in incorrect position reporting.

Start-up characteristics

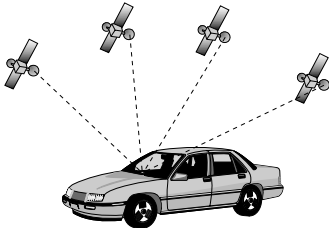

If the vehicle is parked for longer periods of time, the satellites continue their orbit. After the ignition is switched on, it may take several minutes until the navigation system receives signals from sufficient satellites for evaluation.

During the start-up sequence, it is possible that the navigation system will report: "You are leaving the digitised area". The navigation system assumes that the vehicle is located outside a digitised area. If other roads exist in this area, the navigation system may issue incorrect messages. The navigation system assumes that the vehicle is located on another road.

Comments

After transport of the vehicle by train or ferry, the navigation system may require a few minutes for exact positioning.

After disconnecting the vehicle battery, up to 15 minutes may be required for exact positioning. For this, the vehicle must be outdoors and the system must be switched on in order to receive transmissions from the GPS satellites.

The digital road map

To be able to plan a route to a destination address, the navigation system not only requires the current position of the vehicle but also a digital road map containing the destination address itself and the roads leading to the destination address. This digital road map is on the map CD which you insert into the navigation computer.

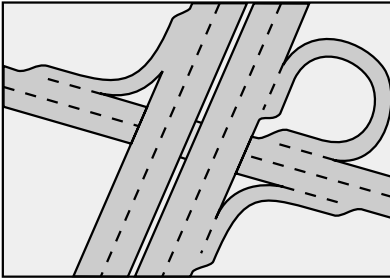

Real road network

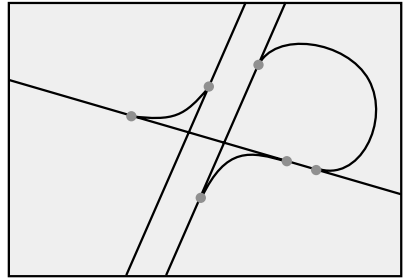

Line pattern of digitized map

The road system is stored on the map CD as a line model, i.e. even large junctions have only one focal point that is approached by all roads in point-to-point fashion. Thus the navigation system indicates the distance to the turn-off point as the distance to the centre of the junction. This is why the distances indicated on main road signs may not agree with those of the navigation system. The road signs indicate the distance to the beginning of the exit.

Areas with limited road information

In some areas, not all of the information on a road is available on the map CD. Thus, for example, turn-off prohibitions, information on the direction of travel in a one-way street or prohibited entry into a pedestrian zone may be missing. The navigation system will display a warning if you drive into such an area. Local traffic laws always take precedence over navigation system instructions. Always observe the road signs and motor vehicle traffic regulations.

Topicality of the map CD

Roughly 10 - 15% of the road system characteristics change each year. Due to these constantly changing traffic conditions (construction of new roads, traffic calming, etc.) we cannot guarantee that the digital road map will be in 100 % agreement with existing traffic conditions. We recommend that you always use the most current version of the map CD for navigation.

C-IQ – Your key to map, traffic and travel information

Your navigation system is supplied with a CD containing the latest version of the map software along with travel and traffic information (for dynamic navigation). The information on the CD is encrypted and can be partially or completely activated for a defined period with the aid of an access code. Your advantages:

- You only pay for the information that you actually use.
- You only pay for the time that you actually use.
- After the first activation, you will automatically receive subsequent CD updates.
- You always have the latest information.
- You can get hold of the activation easily via the Internet, by calling our free hotline or from your dealer.

Activation options

The CD contains the latest version of the road map software. It also contains travel guide information for a number of countries as well as traffic information for dynamic route planning via TMC (in countries which offer this service).

You can activate

- the road data
- individual travel guides and if required
- traffic information

in a number of countries for a certain period of time (see also the preview in this chapter). Your C-IQ Service will be happy to provide more information about the possible access options. You should also read the C-IQ brochure supplied with your map CD.

Registering the navigation system

In order to activate C-IQ products, you must register your navigation system with C-IQ Service. Registering the system also provides you with additional anti-theft protection. If a unit is registered with C-IQ Service as stolen, C-IQ Service will not issue any new activation codes for C-IQ contents.

To register your navigation system, you need the Navi ID. In a small number of cases the Initial ID or version number of your map software is also required.

You can access this data as follows:

- ☞ In the main control, select "C-IQ".
- ☞ Select "Navi ID".
- ☞ The 8-digit Navi ID, the map CD currently loaded and the version number of the navigation software are displayed.
- ☞ To read out the Initial ID, move the cursor to "Initial ID" and confirm your selection by pressing **OK**.
- ☞ The "☐" symbol will take you back to the previous menu and you can access help for the current C-IQ topic by selecting "?".
- ☞ Make a note of the Navi ID. You can now contact C-IQ Service and register your system.

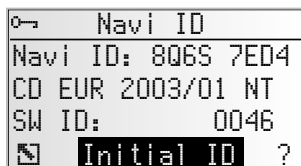

Activating products

Once you have received your activation code, enter it into the system.

⚠ For activation and revocation of C-IQ contents, the navigation system must have sufficient GPS reception during the code input, because time and date information are needed for activating the C-IQ access code. If necessary, check the GPS reception in information menu "GPS / Compass". The number of satellites received should be at least 3. See page 32.

- ☞ In the main control menu, select "C-IQ" then "Code Input".
- ☞ The cursor appears automatically on the first digit of the code.
- ☞ Press **OK** to activate each digit in the code.
- ☞ Next, use the cursor keys to select the correct code digit and confirm your selection by pressing **OK**.
- ✎ You may change any of the code digits at any time by moving the cursor to the required position in the code and pressing **OK**.
- ☞ Once the code is complete, the cursor will automatically move to "OK". Confirm by pressing **OK**.
- ☞ Once you have entered a correct code, the system will display information about the C-IQ products you have just activated.
- ✎ The system will inform you if an incorrect code has been entered, and/or if your system software is not capable of processing the encrypted information.
- ☞ In these cases, select either "OK" or "C-IQ Service", if you wish to establish contact, and press the **OK** key.

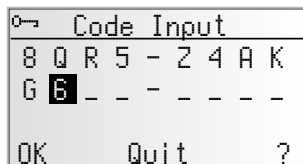

It is possible to operate the system without activation. Destinations can be entered. Navigation information, however, will only be provided for activated areas and for activated services.





My C-IQ

You have the choice of obtaining information about your activation status at any time.

- ☞ Select "My C-IQ" in the "C-IQ" menu.
- ☞ Select "Active products" if you wish to find out more about the products you have activated.
- ☞ Select "Starting soon" if you wish to view details of products you have received which will soon be active.
- ☞ Select "Expiring soon" if you wish to find out which service products you currently have in use and for how long they will continue to be available.
- ☞ Select "Revocated products" to view a list of products which have been revoked.







Preview

Together with your map and travel information software you will also receive the opportunity to inspect different products free of charge before ordering them. You can have the system display the status of this preview:

-  Select "Preview" in the "C-IQ" menu.
-  You will see the status of your preview options. It contains the number of map and travel information products that you are still able to test free of charge.
-  You can access a list of possible preview products via the  symbol.
-  Select the product you require from the list in order to test it for the period of time indicated.



C-IQ Settings

Set up your system so that you are informed about the status of your activated C-IQ products automatically and in good time:

-  Select "C-IQ Settings" in the "C-IQ" menu.
-  Select the number of days (between 1 and 10) you wish to be informed in advance of the expiry or start of the products you have activated.
-  You can use "Expiring soon" and "Starting soon" to select whether you wish to be informed in advance and, if so, which products you wish to be informed about.
-  Select "Return" to go back to the previous menu.
-  If you wish to be informed about the expiry or start of C-IQ products when the system starts up, you can view a list of corresponding products via the  symbol.







C-IQ Info

Here you will find general information about the C-IQ products on the map CD you have loaded.

-  Select "C-IQ Info" in the "C-IQ" menu.
-  This option is only supported by certain map CDs.

C-IQ Service

Here you will find information about your C-IQ Service:

-  Select "C-IQ Service" in the "C-IQ" menu.
-  Select "" to go back to the previous menu.
-  Select " C-IQ" to establish telephone contact with the C-IQ Service Centre.
-  The " C-IQ" option is only active if a telephone module is connected to the navigation system (this function is in preparation).

LCD Monitor

If mounted with the supplied support, the monitor can be removed from the holder for advanced theft protection.

Removing the monitor

 Press the release button on the back of the support and gently pull the monitor upwards.

 **Do not push on the display screen to avoid damage of the LCD.**

Installing the monitor

 Gently slide the monitor onto the support until it clicks into position.

Adjusting the monitor

If mounted on the supplied support, the monitor can be adjusted to your viewing angle.

 Turn the monitor until the best angle of view is reached.

 Press the release button on the monitor support to tilt the monitor to its best position.

Remote control

The VDO Dayton Navigation System is controlled by an infrared remote control.

 Gently pull the remote control forward to release it from the holder.

 **Before driving off, slide the remote control back into the holder until it clicks into position.**

The keys on the remote control have the following functions:

 Play back current guidance advice and (if available) the current TMC message.

HOME Retrieve the "Home" address and activate guidance.

▲ Cursor key upwards; select options.

◀ Cursor key left; select options.

▶ Cursor key right; select options.

▼ Cursor key downwards; select options.

OK OK key; confirm a selection.

— Decrease voice volume of guidance advice.

+ Increase voice volume of guidance advice.

CLR Delete the last entry / back to previous menu.

ALT-R Plan an alternative route.

↵ Activate guidance / switch to guidance screen.

INFO Open the menu "Special dest. -> Info on car pos."

MENU Show main control menu.

FAVOURITE . . . Programmable function key. See page 44.



PHONE Open the phone menu (only if a VDO Dayton hands-free unit is connected).

OPERATION

■ Active remote control holder RCD 3200 (optional accessory)





If you use your remote control in the optional holder RCD 3200, the internal batteries are not used.

When the batteries are exhausted the navigation system may no longer react on key presses.

-  Slide the remote control into its holder to resume normal operation.
-  Replace the batteries. Battery replacement see page 46.

Switching on / off



The navigation system is switched on / off together with the ignition.

-  Switch on the ignition.
-  As soon as the navigation system is operable, an advice on the use of the system appears on the display.
-  Read and confirm this advice by pressing **OK** on the remote control.
-  The "Main control" menu appears.

After a few seconds the system is initialized and you can select the navigation functions (options in highlighted letters).

Stand-by mode





You can switch the system to its stand-by mode as follows:

-  Select "Stop guidance" from the main control menu.
-  The display is switched off and audible guidance advice is muted.
-  Press one of the cursor keys ◀, ▶, ▲, ▼ or the **OK** key on the remote control to resume normal operation.

If the navigation system was switched off in stand-by mode, it restarts in stand-by mode when turning the ignition on again.

Volume

You can adjust the volume of the audible guidance advice as follows:

-  Press the **+** key once or more than once to increase the volume of the voice messages.
-  Press the **-** key once or more than once to decrease the volume of the voice messages.
-  The adjusted volume is announced.
-  The volume can be set so that the volume is increased depending on the driving speed. See "System Settings", page 43.

Cursor

The cursor is used to select menu options or characters. It is shown as white characters on black background.

- For moving the cursor use the cursor keys ▲, ▼, ◀ or ▶.
- Confirm your selection by pressing the **OK** key.
- 🖨 The cursor is briefly displayed as a frame around the selected field.

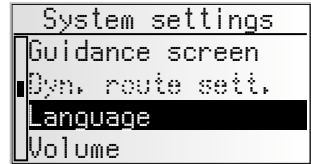

Options currently not available are shown in faint.

Scroll bars

In all menus a scroll bar is displayed on the left margin of the screen which shows you the position of the cursor within the current menu.

- Move the cursor to a menu option on the upper or lower margin of the screen using the cursor keys ▲ or ▼.
- Continue pressing the same key.
- 🖨 Further menu options are shown automatically.

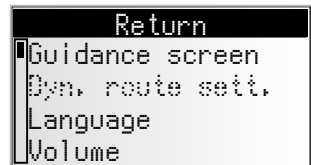

Except for in the main control menu the menu title changes into the "Return" option as soon as you move the cursor to the upper edge of the screen.

- Confirm "Return" with the **OK** key to exit the menu,
- or:
- press cursor key ▲ again to move further up within the menu.

Character input





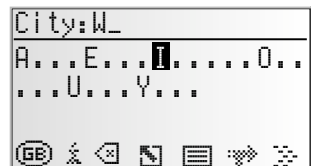





Names are entered by selecting characters from a list. This kind of character entry will simply be called "typewriter" further on in the manual.

- To select a character place the cursor on the desired character by using the cursor keys ◀, ▶, ▲ and ▼.
- Confirm your selection by pressing the **OK** key on the remote control.
- ✎ Characters which are not available are shown as dots and are skipped automatically.
- ✎ Characters entered by mistake can be deleted by pressing the **CLR** key.



Options when entering characters

The bottom line of the display shows command icons with which you can carry out the following functions:

-  : Display and selection of destination country (in this case, "D" for Germany).
-  : Save an address in the personal address book.
-  : Jump to menu "Special dest.". See page 23.
-  : Delete the character entered last.
-  : Direct input of road name without previously entering the name of the city (depending on map CD).
-  : Cancel entry and return to the start of the destination entry.
-  : Display a list of database items.
-  : End of destination input and automatic start of guidance.
-  : Confirm the last entered data and go to the next data entry option.
-  : Accept the data entries (e. g. when entering an address name).



Depending on which information is already entered, one or more than one options are not available (in faint).

Intelligent "Typewriter"

When you enter names of cities and roads or special destinations, the system compares the character string already entered with all database entries on the map CD.

Once you select a character, you will notice that only certain letters remain displayed. The navigation system automatically completes entries if only one possible entry is left.

Entering special characters

-  The typewriter provides the space and the period and, depending upon the language selected, certain country-specific accented characters. If you have selected a system language for which accented characters for the names of cities and roads are not supported, you can enter the name without accented characters (e.g. "MUNCHEN" instead of "MÜNCHEN").
-  For "ß", enter "ss".

Main control menu

You can select the following menu options in the main control menu:

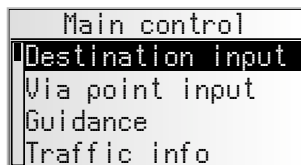

Destination input

This option enters the "Destination Input" menu. Select this option to enter the city, road, junction or a special facility as the destination address. See page 20.

Viapoint input

This option enters the "Viapoint input" menu. Select this option to enter viapoints on the way to your destination. See page 25.

Guidance

This option enters the guidance screen and activates the guidance function.

In addition you have access to different information screens, for example with your current car position, the travel data or traffic information¹⁾. See page 27.

Traffic info¹⁾

Use this option to access information about current traffic conditions analysed via RDS-TMC. See page 33.

 To do this, you must have C-IQ Traffic info data activated.

Address manager

This option opens the "Address manager" menu. With the address manager you can for example manage addresses often used as destinations and viapoints. See page 38.

C-IQ

Use this option to manage your C-IQ data. See page 12.

Emergency

This option opens the "Emergency" menu. Here you get information about your present position and the geographical co-ordinates (GPS position). See page 40.

Phone²⁾

This option opens the telephone menu. For description of the telephone functions please refer to the user manual of the hands-free unit (option).

Stop guidance

This option switches off the visual and acoustic guidance advice. The navigation system remains active in the background.

 Press one of the keys on the remote control to resume normal operation.

Settings

This option enters the "System Settings" menu. Select this option to set your own preferences. See page 41.

Games

Enjoy yourself by playing one of the games provided.

(For safety reasons only when the vehicle is at a stand-still.)

1) Only with TMC extension connected

2) Only with hands-free unit connected

Entering a destination address

You can enter a destination address in various different ways:

- Entering city, road, house number or junction letter-by-letter by means of the “typewriter”. See next page.
- Loading an address from the personal address book. See page 38.
- Loading one of the 20 destination addresses last used.
- Selecting a special facility (for example hotel, petrol station, railway station) from the database stored on the map CD. See page 23.
- Direct entry of geographical co-ordinates (GPS position), for example if your destination is beyond digitized roads. See page 24.
- Transferring a destination from the travel guide information (if you have activated C-IQ Travel Info data).

Destination input menu

 Select “Destination input” from the main control menu.

 The “Destination input” menu is shown.

The following options are available in the destination input menu:

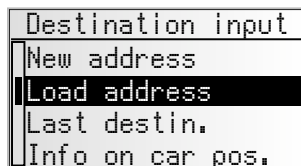

New address

To enter the country, city, road, house number/ junction or a point of interest (special destination).

Load address

To recall a destination address previously stored in the address book.

 Use “Home” or “Work” to load the address stored in this memory location and activate guidance immediately.

Last destin.

To recall one of the 20 destinations last used for guidance.

Info on car pos.

To load a special facility which is located in vicinity of the current car position (depending on the map CD inserted you have access to hotels, restaurants, petrol stations or service areas, garages).

Geo. Long-/Latit

Entering a destination by means of GPS coordinates (geographic latitude and longitude).

Travel info

If you have enabled a C-IQ Travel Info product (e.g. Varta, Michelin, etc.) you can search specifically for particular facilities and transfer them directly as the destination. Detailed information about advanced search options can be found in the Travel Info brochure supplied with the map CD.

Entering a new address

An input wizard will help you enter a new address. It will lead you step by step through all the necessary entries such as country, city, road, house number or crossroads and required routing criterion.

Step 1: City or postal code

Select "New address" in the destination input menu.

The display automatically shows "City:" and the typewriter window, the name of the last destination city is already displayed.

If you want to enter a destination address in the city shown, simply select "»".



or:

Enter a new city name or postal code via the "typewriter".

or:

Select the list symbol and choose an entry in the database.

If several database entries have the same name, the cursor automatically moves to the symbol. Select the required entry type from the list.

If there is a large number of possible entries, it may take several seconds to build the list.

Confirm your selection with "»".

■ Change country

The currently selected country appears as a country code in the bottom left of the typewriter window when a city is entered.

If you wish to change the destination country, move the cursor to the country code and confirm your entry.

The list of countries stored on the current map CD appears.

Countries not currently activated appear in "< >".

Select the required country from the list.

You can also enter destinations in countries which have not been activated. You will then only receive directions until you reach the border of that country.

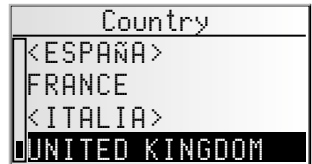

■ Quick Access (to destination addresses via road names)



This function is particularly useful for reducing the input time for unusual road names. If the loaded map CD supports this function, the quick access symbol will appear in the window for entering the city name.

Select the symbol in the typewriter window.

Once the complete road name has been entered, only the initial letters of the cities in which a road with that name is located will appear in the typewriter window.

If necessary, you should now enter the required city name and confirm your entry with "»".





Step 2: Road

-  Once the city has been entered the input wizard automatically jumps to the "Road:" input menu.
-  Enter the name of the road using the "typewriter" or select a name from the list using .

Step 3: House number or junction

If house numbers are available for a selected road, they can be entered with a separate input menu. If no house numbers are available, the system automatically jumps to the "Junction" input menu.

If no junction is available, this step will be skipped.

-  After confirming the road name with "»", the input menu for the house number or junction appears.
-  Enter the required house number or junction.
-  Within the database, certain ranges of house numbers are combined, the entered house number being in such a range. In such a case, the navigation system will lead you to the entered house number range.
-  In some cases, the navigation system will also correct your entry. If for example you have entered house number 83 but only numbers up to 51 are stored on the map CD, the system will automatically correct this to 51.

Step 4: Route selection







The required criterion for route planning can be modified even after all data for the destination has been entered.

A detailed description of the route criteria can be found under "Route selection" on page 30.

Once the route criteria are selected, the system jumps to the guidance screen and begins planning the route. Within only a few seconds you will begin to receive guidance information.

Directly to guidance

While using the input wizard, you can, at any time, jump to guidance, e.g. if certain information on the destination address is unavailable (house number, crossroads) or if you wish to be guided to the city or town limits only. In that case, proceed as follows:

-  Enter at least the name of a city as described earlier.
-  After input, press the  key on the remote control, or:
 -  select the  symbol in the lower line of the input menu.
-  The guidance screen appears.
-  The route is being planned.

For further information about guidance, see the chapter entitled "Guidance" on page 27.









Special destinations (POIs)

You may also input the destination address by selecting special facilities (POI = Points of Interest) stored in the database. These include e.g.:











- airports,
- hotels,
- petrol station,
- car repair garages
- car parks, etc.

Depending upon the information already entered in the destination input screen, a list of general interest facilities appears which are present on the current map CD.

Special facilities of national importance

-  Select "New address" and use the input wizard to select the required country.
-  Then, select the **i** symbol in the lower line of the input menu.
-  A list of the categories of points of national interest is shown.
-  Select the required category (e.g. AIRPORT, FERRY...).
-  If more than four facilities are stored for the selected category, the "typewriter" will be displayed.
-  For up to four stored facilities, the list will appear immediately.
-  Enter the name of the required facility or select the  symbol for the list display.
-  Confirm the input using "»»" or select an entry from the list.

Special facilities in connection with the destination

-  Select "New address" and use the input wizard to enter the required country and the name of the required destination.
-  Then, select the **i** symbol in the lower line of the input menu.
-  A list of categories of special facilities is shown.
-  For smaller towns, it may be that only the "CITY CENTRE" option is available. If you select this option, the navigation system will guide you to the city centre.
-  Select the required category (e.g. HOTEL, PETROL STATION...).
-  If more than four facilities are stored for the selected category, the "typewriter" will be displayed.
-  For up to four stored facilities, the list will appear immediately.
-  Enter the name of the required facility or select the  symbol for the list display.
-  Confirm the input using "»»" or select an entry from the list.

Special facilities in the vicinity of the current position

You may also set a destination address by selecting a special facility in the vicinity of the current vehicle location.

☞ Press the **INFO** key on the remote control,

or:

☞ select "Info on car pos." in the destination input menu.

📄 A list of categories of special facilities is shown.

☞ Select the required category.

📄 A list of facilities pertaining to the selected category, located in the vicinity of the current vehicle location, appears. Additionally, distance and direction to the facilities are shown.

☞ Proceed as described on the previous page.



Note:

You will always see a list of facilities from "Info on car pos.", even if there is no facility from the selected category directly at the car position.

The facilities list is sorted by distance to the car position, i.e. the facility closest to the car position will be first in the list.

Destination input via GPS coordinates

If you know the GPS coordinates of a destination, you may enter them directly.

☞ In the main control, select "Destination input".

☞ Select "Geo. Long-/Latit" from the "Destination input" menu.

📄 The GPS coordinates input menu appears.

☞ Mark the required coordinate using the cursor keys. Then press **OK**.

☞ Next, set the required values for degrees, minutes, seconds and north/south or east/west using the cursor keys. Confirm the destination input with "OK".

📄 The navigation system compares the GPS coordinates you entered with the data on the current map CD and plans the route.

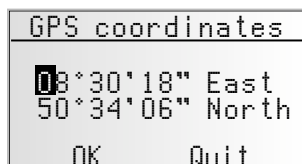

Notes:

If the destination is beyond the digitised roads, the system will guide you along digitised roads as far as possible. The system will then display the linear direction and the distance to the destination.

If the GPS coordinates you entered should be outside the limits of the current map CD, the system will display an error message.

Via point input

If you wish to visit other locations en route to the entered destination address, these can be stored as via points. The navigation system then plans the route to include the via points in the given sequence before the destination address is reached.

When you reach a via point, you will hear "You have arrived." The navigation system will immediately begin to plan the route to the next via point or the final destination.

In the address manager or on the "Via points" information screen you can delete via points you have not reached yet or which you do not wish to visit any longer. See page 32 or 38.

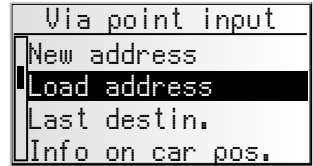

 In the main control, select "Via point input"

 The "Via point input" menu appears.

The following options are available in the "Via point input" menu:

New address

Input country, city, road, number or crossroads or special facility as via point.

Load address

Loading an address stored in the address book as a via point.

Last destin.

Recall one of the 10 addresses last used for guidance to load as a via point.

Info on car pos.

Loading a special facility in the vicinity of the current position of the car.

Geo. Long-/Latit

Entering a destination by means of GPS coordinates (geographic latitude and longitude).

Travel info

If you have enabled a C-IQ Travel Info product (e.g. Varta, Michelin, etc.) you can search specifically for particular facilities and transfer them directly as the via point. Detailed information about advanced search options can be found in the Travel Info brochure supplied with the map CD.

The input of a via point is identical to the input of a destination address.

Delete via points not reached

Via point which you have not reached or which are no longer desirable to you must be deleted from the via point list so that the navigation system may plan the route to the next via point or to the final destination. If a not reached via point is not deleted, the system will continue to try and guide you to this via point.

Via points can be deleted in the address manager or on the "Via points" information screen, see page 38 or page 32.

Notes:

The maximum number of stored via points is 25.

The via points are targeted in the order in which they are entered.

For guidance to the via points, the system automatically uses the route planning criterion for the final destination.

It is possible to enter new via points en route to the final destination at any time.

Once a via point has been reached ("destination reached"), it is deleted from the list of via points.

If you enter a new destination you will be asked whether you also wish to delete the via point list. If you answer "No," the remaining via points will be retained for the new destination address.

Via points are not stored in the list of last destinations (destination input and via point input).

Via points cannot be stored with "Store address" in the address manager.

Guidance screen

The guidance screen appears as soon as you activate the guidance.

The guidance screen displays the following information:

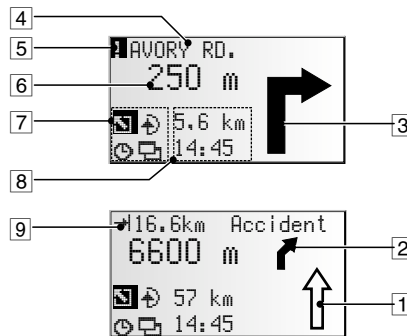

- 1 Road direction arrow: The arrow indicates the course of the road.
- 2 Simplified presentation of the next turn-off prompt.
- 3 Turn-off prompt: A graphic display of the next crossroads or junction. In addition, directional changes are announced with audible messages.
- 4 Road into which to turn at the next announcement.
- 5 You are in an area with incomplete map information.
- 6 Distance to the next change in direction.*
- 7 Option field. Move the cursor to the required symbol and confirm:
 - : Return to the main control
 - : To "Alternative route" menu. See page 37.
 - : Display and select route criterion. See page 30.
 - : To information screens. See page 31.
- 8 Status field. Display of the following possible information:
 - Remaining driving distance
 - Remaining travel time
 - Estimated time of arrival
 - Current time

You can configure the status field in the "System settings" menu. See page 45.
- 9 Only with optional TMC extension:

As soon as any traffic obstructions reported by TMC pertain to the planned route, a brief message appears, indicating the distance to the nearest obstruction and its type.

* The measuring units are dependent on the system settings. See chapter "System Settings", page 41.

Audible messages

During guidance, the navigation system will provide acoustic routing information in addition to the symbols on the guidance screen. Commonly, the directive to turn into another road consists of two voice messages:

an early warning

e.g. "Right turn ahead"



and

the instruction to turn

e.g. "Turn right in 200 metres"



"Turn now" advice

In addition to information regarding turning, the system also provides "turn now" advice, which is output directly at the turn-off point.



 The "Turn now" advice can be deactivated in the "System settings - Language" menu.

Improved acoustic guidance information

In many countries, "speaking" road signs are available for main road slip roads (e.g.: "Take exit number 7 and follow the B 429").

Repeating voice message

Did you miss the last guidance message or didn't you fully understand it?

 Press the  button.

 You will hear the current guidance message.

Did you ignore the last message?

If you did not follow the last guidance message or if you were not able to follow it due to traffic conditions (road works, etc.), the system will, within a few seconds, plan a new route from the current position of your car to your destination.

On longer route segments without junctions or crossroads, an arrow is displayed indicating the course of the road over the next approx. 100 m. In addition, a reduced diagram of the next turn-off prompt appears on the left, above the route direction arrow. Thus, the driver is always warned in advance of the next change of direction.

Shortly before the change of direction, the detailed turn-off prompt appears.



Guidance beyond digitised roads

If you leave a digitised road, the arrow pointing to the nearest digitised road will appear automatically.

 If that is the case, continue in the direction of the arrow until you reach a digitised road.

As soon as you return to a digitised road, you will receive destination guidance again.



Areas with limited road information





In some areas, not all of the information on a road is available on the map CD. Thus, for example, turn-off prohibitions, information on the direction of travel in a one-way street or prohibited entry into a pedestrian zone may be missing. The navigation system will display a warning if you drive into such an area. Local traffic laws always take precedence over navigation system instructions.

At the top left of the guidance screen, you will see the  symbol, as long as you are in an area with limited road information.

 **Always observe the road signs and motor vehicle traffic regulations.**

Route selection

During guidance, you may also modify the route criterion and activate or deactivate dynamic route planning. The system will then plan a new route taking into account the new setting of the current position of your car.

 In the guidance screen, select the symbol for route selection (on the basis of the setting in the destination input , ,  or ).

The following options are available:

- Dynamic route*: Use this option to specify whether or not TMC traffic information should be taken into account in route planning.
- Fast: If you prefer a fast route
- Short: If you prefer a short route
- Main roads: If you prefer expressways
- No main roads: Avoids expressways

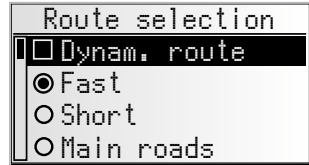

In addition, you can bypass toll roads when planning your route.

 Activate the “No toll road” option if you wish to avoid toll roads as much as possible.

 If no toll-free roads are available, toll roads will be included for planning the route.

Note: If this option is activated, route planning may take longer than the time needed with this function deactivated. Therefore this option should only be activated if needed.

* only with TMC extension connected

Information during guidance

During guidance, you can call up several information screens:

- Move the cursor to the  symbol and confirm by pressing **OK**.
- The list of information menus appears.

The following information menus are available:

Route list

This option is available as soon as a route has been planned.

The list of segments of the planned route appears.

- Confirm the required entry by pressing **OK** in order to view the complete road name.
- Select "Return" to quit the road list.

Travel data	
Route list	
Event on the route	
Destination	
Via points 2	

Route list	
B277	0.5km
B49	0.3km
Ab Anschl	0.7km
A45	18.8km

Event on the route

This information menu is only available if a TMC extension is connected to the navigation system and if one or more traffic obstructions are reported on your route.

A list of segments for which traffic obstructions have been reported appears. The list is sorted on the basis of the location of each obstruction on the route.

- Select a report in order to access detailed information about the traffic obstruction.

Event on the route	
B67	-> 109km
B43A	-> 126km

More detailed information about this function can be found in the "Traffic info" chapter on page 33.

Car position

Display of current vehicle location with country code, city, road, and, if available, house number.

If you are located beyond a digitised road, the screen will display the GPS position (geographic longitude and latitude).

- The GPS position can be accessed at any time via the "Emergency" option in the main control.

Return	
	GB
OAKRIDGE	
PARK AVENUE	

Displaying/deleting via points

If via points have been entered for the current destination, the "Via points" option will be active. The number of via points still to be reached also appears.

- ☞ Select the required via point from the list in order to view details or delete it.



Destination

Display of current destination address with Name (if entered), country code, city, road, and crossroads.



GPS / Compass

Display of the following information:

1. GPS reception status: Displays the number of GPS satellites received. With an unobstructed view of the sky, up to 8 satellites may be displayed.
2. Current driving direction (compass). The arrow always points north.
3. Date and time



Trip computer

The following information appears in the "Trip computer" information menu:

- Current speed
- Average speed
- Maximum speed so far
- Distance travelled
- Time travelled

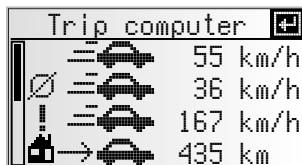

■ Resetting values:

- ☞ Confirm  by pressing **OK**.
- ☞ Confirm the deletion with "Yes".
- ☞ All trip computer values are reset to zero.

■ Speed warning:

You can enter a speed above which an alarm will sound. To set the speed limit, see "Speed" on page 41.

Traffic information

Use the "Traffic info" option in the main control to obtain information about traffic conditions in three different categories:

- At the car position
- At the destination
- On the route

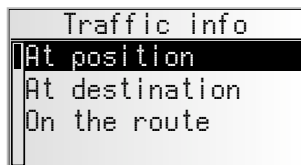

 Please note that the RDS-TMC station picked up by the TMC receiver may not provide any traffic information relating to your destination if the destination is located outside the station range.

 C-IQ Traffic info contents must be activated to ensure this function.

■ At position

All traffic obstructions in the vicinity of the current position of your car transmitted by the RDS-TMC station are displayed here.

■ At destination

All traffic obstructions in the vicinity of the selected destination transmitted by the RDS-TMC station are displayed here.

■ On the route

All traffic obstructions on the route are displayed.

 If no traffic information is received or there are no traffic obstructions on the route, the corresponding menu items will be greyed out.

Viewing details relating to traffic information

 Select the required traffic report from one of the three lists ("At position", "At destination", "On the route") in order to view details relating to traffic information.

 The first details screen appears:

The following information is available:

- Road affected
- Distance to the start of the segment in which the traffic obstruction is located;
- Length of the section in which the traffic obstruction is located;
- Type of obstruction (e.g. road works, stationary traffic, closed road).

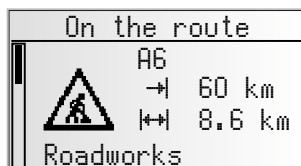

As soon as you enter the segment affected by the traffic obstruction, the distance-to-go information will disappear.

* only with TMC extension connected

TRAFFIC INFORMATION

 You can use cursor key ▼ to access further screens containing details about the selected traffic obstruction.

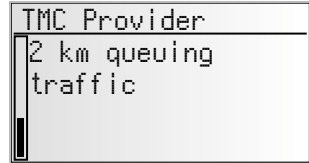
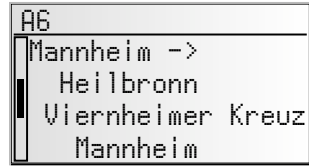

 The second details screen indicates the section in which the traffic obstruction is located and the third, the information about the obstruction provided by the TMC provider.





 Press **OK** to return to the list of traffic obstructions.

Searching / selecting TMC stations

 Select "TMC Provider" from the "Traffic info" menu.

 Select the  icon.

 The list of available TMC stations is displayed.



 Select the desired station from the list.

 Select "Automatic" if you want the receiver to automatically tune to the strongest station for evaluation of the TMC data.

 Each time after switching off the ignition "Automatic" is set automatically.

With RDS TMC (Traffic Message Channel), the current traffic situation is taken into account when planning the route to your destination. You will be informed, for example, of accidents, congestion or construction sites as soon as such a traffic situation occurs.



If you approach the traffic obstruction, the automatic detour option is activated and the navigation system will plan, if required, an alternative route.

-  TMC has not yet been introduced in all countries and is not supported by all RDS stations.
-  In order to be able to use dynamic guidance with TMC, you must have activated C-IQ contents with Traffic info.

How TMC traffic announcements are made

If TMC messages are available for your planned route, they will also be announced as voice messages.

Repeat announcement

-  Press the  key.
-  You will hear the current destination guidance message and the most recent TMC message.

TMC traffic information on the guidance screen

If a traffic obstruction occurs ahead of you on the planned route, you will see information about the obstruction on the top line of the guidance screen.

Information appears regarding the type of traffic obstruction and the distance to the start of the segment in which it is located. Details about the traffic obstruction can be accessed via the "Event on the route" information menu. See page 31.



As you approach the traffic obstruction, the detour option is activated. You will hear an audible signal and the cursor will jump automatically to the top line of the guidance screen.

-  The display of the traffic obstruction in the top line of the screen can be deactivated. See page 41.









* only with TMC extension connected

Bypassing a traffic obstruction locally

When you approach the last exit before reaching a traffic obstruction, the navigation system will alert you and offer you the option of planning a detour route.

As soon as a traffic obstruction is detected on your route and the detour option is displayed on the guidance screen:

-  Confirm the detour option in the top line of the guidance screen.
-  The detour menu is displayed.
-  Confirm "Plan a detour?" with "Yes," if you wish to bypass the traffic obstruction.
-  Select "No," if you do not wish to plan a detour.

-  If you answer "Yes", the navigation system will plan a new route in a matter of seconds. A details screen will soon appear (diversion, time delay/saving).
-  Confirm the planned detour with "Yes" or reject it with "No".
-  If you reject the planned detour, the direct route (which might go through the traffic obstruction) will be planned.

Alternative route	
Distance:	+9.0 km
Time:	+13 min
Accept alteration?	
Yes	No

Dynamic route planning

Unlike dynamic guidance, which provides information about traffic conditions on your route and on request about local traffic conditions, dynamic route planning takes into account the whole of the current traffic situation in a configurable area (horizon) in the vicinity of the current position of the car. If a traffic obstruction (e.g. stationary traffic) is reported via TMC for the planned route, the navigation system will analyse the information and calculate the anticipated delay.

If there is a traffic problem on the planned route, you will be informed of this by the navigation system and may decide whether the system should take a detour by changing the route in order to avoid the segment concerned or whether it would be more sensible just to drive through the problem. You should base your decision on the anticipated delay calculated by the system.

-  The delay is calculated by the navigation system on the basis of the data transmitted by the TMC station, which may not actually reflect the current situation.



Dynamic route planning can be activated in the "Route selection" menu. See page 30.

In addition, you may select criteria on which dynamic route planning should be based in the "Settings – Dyn. route sett." menu. See page 42.

During guidance, you can cause the navigation system to plan an alternative route. Use this function if, for example, you want to avoid stationary traffic not reported via TMC or if you wish to plan an alternative route.

The alternative route will be calculated for a selectable distance from the current position of the car.

 Press the **ALT-R** key on the remote control,
or:

 move the cursor to the  symbol in the guidance screen and confirm by pressing **OK**.

 If you agree with the displayed distance, confirm with "**OK**".

 The system is planning an alternative route for the entered distance. A details screen will soon appear (diversion, time delay/saving).

 Confirm the planned alternative route with "**Yes**" or reject it with "**No**".

 If you reject the alternative route, the navigation system will plan a new route to the destination from the current position of the car.

 The display shows the guidance screen again.

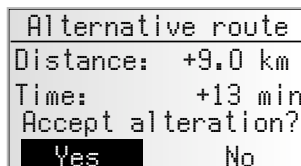

Cancel procedure

 Move the cursor to "**Quit**" and press **OK**.

Change distance

If you wish to change the distance displayed, proceed as follows:

 Move the cursor to the displayed distance.

 Press **OK**.

 Change the displayed distance in the range of 1 to 10 km using cursor keys **◀** or **▶**.

 Press **OK** again.

 The cursor is set on "**OK**".

 Confirm with "**OK**".

 The system will suggest an alternative route for the planned trip as described above.

Address Manager

The VDO Dayton Navigation System allows you to store 30 destination addresses in a personal address book. In the address book, you can store your destinations separately under the categories "Private" and "Business". The "Home" and "Work" shortcuts, which can be programmed with your home address and business address respectively, are also available here.

- ☞ Select the "Address manager" in the main control and confirm the selection.
- 📄 The address manager is displayed.

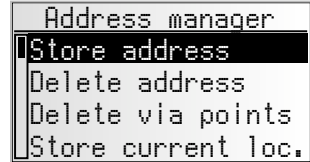

The following options are available:

Storing addresses in the address book.

If you have not yet entered a destination address:

- ☞ Enter the data of the required destination address (city, road, crossroads or special facility) into the destination menu.
- ☞ In the main control, select the "Address manager" option.
- ☞ Next, select "Store address".
- ☞ Select which address books the address should be stored in (private, business, home or work).
- 📄 The name input menu appears (only for "Private" and for "Business").
- ☞ Using the "typewriter," enter any string of up to 15 characters as the name for the address. Complete the input with "OK".
- 📄 If you do not wish to enter a name, select "OK" directly.
- 📄 The address is now stored in the selected address book.

Delete address

Addresses that are no longer needed should be deleted from the address book to ensure sufficient space for new addresses.

- ☞ Select "Delete address" in the address manager.
- ☞ Select which address book the address should be deleted from (private, business, home or work).
- 📄 A list of the destination addresses stored in the selected address book is displayed.
- ☞ Select an address to be deleted from the list and confirm your selection.
- 📄 The selected address is deleted from the address book.







Delete via points

If via points have been entered for the current destination, you can display the via point list and delete via points from it.



- ☞ Select "Delete via points" in the address manager.
- 📄 A list of the stored via points appears.
- ☞ Select a via point to be deleted from the list and confirm your selection.
- 📄 The selected via point is deleted.
- 📄 Via points can also be deleted in the "Via points" information menu, see page 32.

Store current loc.

Would you like to store a favourite restaurant in the destination memory? You can store the current position of your car as follows:





-  Select "Store current loc." in the address manager.
-  Select which address books the address should be stored in (private, business, home or work).
-  The name input menu appears (only for "Private" and for "Business").
-  Enter a name and complete the input with "OK".
-  If you do not wish to enter a name, select "OK" directly.
-  The current position of the car is stored as an address in the selected address book.

Deleting list of last destinations

-  Select "Delete last dest." in the address manager.
-  The list of destinations last used for guidance is displayed.

Renaming addresses

If you wish to change the name of a destination address, select the "Rename address" option in the address manager.

-  Select which address book the address should be edited in (private, business, home or work).
-  Select the address to be edited from the list and enter a new name for it.
-  Confirm your entry with "OK".
-  The address will be stored under the new name in the address book.

Comments:

30 entries is the guaranteed minimum of entries for the address book. This total can be up to 200, depending on the data entered (e.g. with or without a name, etc.)

If there is no address in the address book, the "Delete address" option cannot be selected.

If no via points have been entered for the current destination, the "Delete via points" option cannot be selected.

Once the address book is full, the "Store address" and "Store current loc." options will no longer be available.

Emergency menu

- ☞ Select "Emergency" from the main control menu.
- ☞ The "Emergency" menu is shown.

The following options are available in the "Emergency" menu:

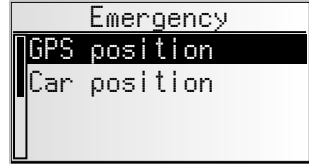

GPS position

Shows the current geographical position of the vehicle evaluated by the Global Positioning System. The degrees of longitude and latitude as well as the height above sea level (sufficient GPS reception must be provided).

Car position

Shows the current vehicle position with country code, city and road. This option is only available if you are located on a digitised road.

To customise the navigation functions to your own needs, you can change several settings.

- In the main control, select "System settings".
- The "System settings" menu is displayed.

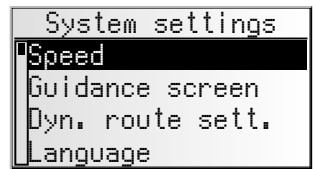

The following options are available:

Speed

In the "Speed" menu, you can configure the following settings:

Speed correction

The navigation system uses an average cruising speed to calculate the remaining travel time and the estimated time of arrival. If required, you can adapt this speed to your actual average speed.

However, we do not recommend you deviate significantly from the standard value of 100%.

- Move the cursor to the value after "Correction".
- Press **OK**.
- Set the required speed correction using cursor keys ◀ or ▶.
- To save the setting press **OK** again.

Speed limit

Use this value to specify the vehicle speed at which a speed warning should be output.

- Move the cursor to the value after "Limit (km/h):".
- Press **OK**.
- Set the required speed using cursor keys ◀ or ▶.
- To save the setting press **OK** again.

Activating/deactivating speed warning:

- Move the cursor to the option after "Limit:".
- Press **OK** to choose between "On" and "Off".
- If the speed warning is activated, a warning sound is triggered each time the set speed limit is exceeded and a warning appears on the screen.

SDVC Mode (Speed dependent volume control)

This is to compensate the surrounding noise by increasing the volume level of guidance advice depending on the car's speed.

You can select between 5 different SDVC settings (OFF = off; 4 = maximum increase).

- Move the cursor to the value after "SDVC mode".
- Press **OK**.
- Set the desired SDVC mode using the cursor keys ◀ or ▶.
- To save the setting press **OK** again.

Find a suitable compensation by trying out the different modes.

Guidance screen

Here you can select the information which should appear on the guidance screen.

■ Show event

 Select whether traffic obstructions on your route should appear in the top line of the guidance screen or not.

■ Remain. distance

 Select whether the distance-to-go to the destination or via point should appear in the status field of the guidance screen or not.

■ Times

 Select which times should appear in the status field of the guidance screen. The following options are available:

- Time of arrival
- Remaining time
- Current time
- No time display

Dyn. route sett.

Settings for dynamic route planning

■ Re-route lev.

Use this setting to specify whether the navigation system should plan a detour in the event of traffic obstructions or not. Five levels are available. The lowest level (1) means that the direct route should go through the stationary traffic depending on the conditions and the anticipated delay. If the highest level is selected, an alternative route should be planned in most cases.

 Level 3 is a standard setting for dynamic route planning. It is the factory setting (default).

■ Horizon







This setting determines the radius in which the navigation system should take traffic obstructions into account when planning your route. Select a value between 25 and 150 km.

■ Delay

Use this value to indicate the anticipated delay time due to a traffic obstruction at or above which the navigation system should suggest that a new route be planned. Select a value between 5 and 60 minutes.

 The anticipated delay is calculated on the basis of the data received from the TMC station and may deviate from the actual situation.

Language

-  Choose one of the two languages loaded in the system,
or:
-  Select "Other language" to replace one of the two loaded languages with another language from the supplied "VDO Dayton Language Loading Software CD".
-  Select the language to be replaced.
-  You will be prompted to insert the CD.
-  Insert the CD in the navigation computer.
-  Follow the system instructions for loading other languages.







■ Turn now advice

If this option is activated, an additional prompt (e.g. "Now turn right") will be output directly before a turn-off.





-  This prompt is activated by default.

Volume

Adjusting the volume:

-  Place the cursor on the volume slider.
-  Confirm by pressing **OK**.
-  The volume adjustment is activated now.
-  Adjust the desired volume level with the cursor keys ◀ or ▶.
-  The selected volume setting is announced.
-  Press **OK** again to store the setting.

Voice messages on/off:

-  Place the cursor on the option behind the loudspeaker icon.
-  Press **OK**.
-  Select Mode "On" or "Off".
-  Press **OK** again to store this selection.





Date / Clock

You can set the format for time and date display as well as the time zone.

Time zone:

The navigation system receives the Universal Time Coordinated (UTC) via the GPS system.

To adjust the difference between your local time and UTC:

-  Place the cursor on the value behind "Timezone:".
-  Press **OK**.
-  Adjust the time offset with cursor keys ◀ and ▶.
-  Press **OK** again to store the setting.
-  The displayed time is updated.



Time format:

 Select between 12 hour format and 24 hour format.

Date format:

 Select between "day.month.year" and "month/day/year" format.

Display

For overhead mounting of the display it is possible to rotate the display contents 180 degrees.

 Select the desired setting according to the mounting position of the display.

Remote control

■ Steering wheel

Activate this option if you want to control the system with a VDO Dayton steering wheel remote control (accessory).

■ Favourite button

You can assign a function to the **FAVOURITE** key on the remote control.

 Select one of the displayed functions to assign it to the short or long press of the **FAVOURITE** key.

Measuring units

 Select between the following measuring units:

- Metric: display in kilometres and metres;
- Anglo: display in miles and yards;
- American: display in miles, half and quarter miles and feet.

Mounting angle

To adapt the navigation computer to the mounting angle at the installation position (gyro-sensor compensation). This adjustment only needs to be made once, immediately after the installation of the navigation system. See "Setting the mounting angle", page 54.

Default settings

Select this option if you want to reset all user specific settings and values to their factory defaults. All address book entries remain stored.

Service

For analysing hardware and software problems (code protected).

The "Service" menu should only be entered for service of the Navigation System by an authorized service centre.

System information

The "System information" menu shows you information on soft- and hardware versions of the system (for service purposes).



Notes on map CDs

The navigation system is based on a C-IQ database, which is stored on a CD in encrypted format. The CD contains map data for navigation as well as travel and traffic information (TMC) for dynamic route planning. You can customise your navigation package by activating specific components of the database.







For further information see "C-IQ - INTELLIGENT CONTENT ON DEMAND", see page 12.

Changing the map CD

If the ignition is switched on and the red power LED lights up permanently:

-  Press the ▲ key on the navigation computer.
-  The CD is ejected.

If the ignition is switched off and if the power LED flashes:

-  Press the ▲ key.
-  Wait for at least 10 seconds until the LED stops flashing.
-  Press the ▲ key again.
-  The CD is ejected.
-  Take out the CD and gently insert the new map CD with the printed side facing up until it is retracted.
-  The system needs a few seconds for initialisation after changing the map CD.

Notes:

Only use genuine VDO Dayton C-IQ map CDs. These map CDs are exclusively designed for use with the VDO Dayton Navigation System and they are only readable by a VDO Dayton Navigation System.

The CD player of the navigation system does not play any other CDs (i.e. Audio CDs).

Always store map CDs in their protective cases.

Always make sure that the CD you insert is clean and dry.

If the last entered destination address is not (or only partly) on the map CD you inserted, the whole address (or only the not existing part) is deleted.

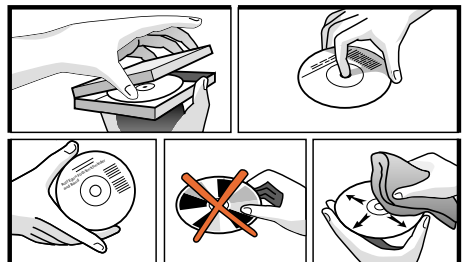

Replacing batteries of the remote control

You have to replace the batteries of the remote control, if you use the remote control outside of its holder and the navigation system does no longer respond to key presses.

- ✎ Open the battery compartment on the back of the remote control.
- ✎ Remove the discharged batteries.
- ✎ Insert two new LR03 type (Size AAA) batteries. Pay attention to correct polarity (marked in the compartment).
- ✎ Close the battery compartment.

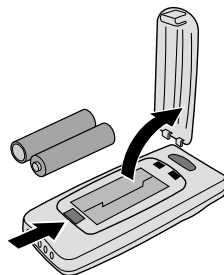

Notes:

In many countries exhausted batteries may not be disposed of with your household waste. Please determine how to dispose of exhausted batteries according to local regulations.

Only use leak-proof batteries. Battery leakage can cause damage to the remote control or to your car.

Never expose the remote control to direct sunlight or extreme heat. The batteries are discharged and the risk of leakage is increased.

If you permanently use your remote control in the active holder RCD 3200 (accessory), we recommend that you remove the batteries from the remote control.

Cleaning of the remote control and the monitor

Do not use lighter fluid, methyl alcohol or other solvents for cleaning. Only use a damp cloth.

Loading software updates

In order to extend the range of functions, you can load software updates from a system software CD, provided that these are available for your system:

- ✎ Switch on the ignition and confirm the safety notification.
- ✎ Remove the map CD from the navigation computer and insert the software update CD.
- ✎ A security check appears. Confirm the inquiry with "YES" if you wish to overwrite the software which is loaded on the system.
- 🖥 The new operating software is now loaded automatically. Loading progress is indicated by a bar.

⚠ On no account must the ignition be switched off during the loading procedure, even if no displays appear on the monitor for a while.

- 🖥 After successful loading, you will be prompted to remove the software update CD and to re-insert the map CD.
- ✎ Please confirm the completion of the loading procedure with "OK".
- 🖥 The system is subsequently re-started with the new operating software.

There may be times when you suspect that your navigation system is not functioning as you expect it to. Before calling for service please read the operating instructions and check the following list. You may find that an apparent malfunction can easily be rectified.

Symptoms	Possible cause / Remedy
System does not start. Nothing on the display.	<ul style="list-style-type: none"> • Switch on the ignition. Ignition is already switched on: System is in stand-by mode. • Press one of the keys on the remote control.
	Monitor connector is not locked correctly. <ul style="list-style-type: none"> • Slide the monitor onto the support (connector) until it clicks into position correctly.
After some time of normal operation, the system switches off.	At extreme high or low temperatures the built-in protection circuit switches off the system automatically. <ul style="list-style-type: none"> • Operation of the system is resumed as soon as the temperature returns to a normal level.
System does not react on key presses when the remote control is not in its holder.	Batteries are empty. <ul style="list-style-type: none"> • Replace the batteries. With active Holder RCD 3200: <ul style="list-style-type: none"> • Put the remote control into the holder.
System reacts very slowly to data entries or calculates very slowly.	You are in a very densely digitized area. The navigation system has to read a large amount of data from the CD-ROM.
The number of satellites in the "GPS/Compass" information menu is 0.	<ul style="list-style-type: none"> • Make sure the GPS aerial is not covered by any objects. • Drive outdoors, if you are in a garage, a car park or a tunnel.
Guidance advice not audible.	<ul style="list-style-type: none"> • Make sure that the volume is not set to minimum.
	<ul style="list-style-type: none"> • Make sure that the voice messages are activated in the "System settings – Volume" menu ("D": On).
Display shows "Please insert CD" or "Please insert correct CD"	<ul style="list-style-type: none"> • Make sure that an appropriate CD is inserted with the printed side facing up in the navigation computer.
Map CD is ejected unintentionally without pressing the ▲ key.	The CD might be dirty. <ul style="list-style-type: none"> • Try to clean the CD with a special CD cleaning fluid.
Not possible to store address in the address book.	Address book is full. <ul style="list-style-type: none"> • Delete one or more entries no longer required.
Guidance is not precise.	Inaccuracy of a max. of 30 m is possible. <ul style="list-style-type: none"> • If you frequently discover greater inaccuracy, contact an authorized service centre.
	The navigation system indicates the distance to the next turn as the distance to the centre of the junction (especially for extensive junctions or crossroads).
Displayed car position does not match actual car position.	Bad GPS reception for a longer period of time (for example caused by interference). When sufficient GPS reception is resumed the position is corrected automatically. <ul style="list-style-type: none"> • If necessary wait a few minutes.

TROUBLESHOOTING





Symptoms	Possible cause / Remedy
Guidance advice does not correspond with actual traffic situation.	It is possible that the car position calculated by the navigation system is currently wrong.
	The route may have been changed and does not correspond with the information stored on the map CD.
The time in the "GPS/Compass" information menu is incorrect.	Set the correct time zone in the "System settings – Date / Time" menu.
Estimated time of arrival is wrong in the guidance screen.	Check that the correct time zone in the "System settings – Date / Time" menu is set.
TMC icon in the "Traffic info" menu is always coarsely shaded, no traffic info is displayed.	The inserted map CD does not support TMC. Insert a map CD which supports TMC.
TMC icon in the "Traffic info" menu is finely shaded.	TMC reception is interfered / obstructed or you are located in an area in which no RDS station broadcasts TMC information.
C-IQ	
During guidance, no traffic information is displayed, even though a TMC extension is connected to the system.	You do not have a C-IQ Traffic info product activated. <ul style="list-style-type: none"> • Contact C-IQ service to activate C-IQ Traffic info contents.
No more directions shortly after crossing the border. Only the direction arrow is appearing in the guidance screen.	You are travelling in a country for which you do not have activated C-IQ map contents. <ul style="list-style-type: none"> • Contact C-IQ Service to activate map data for the required country.
Display shows "Please insert correct CD".	<ul style="list-style-type: none"> • Check that you have inserted a map CD which contains C-IQ data. Map CDs without C-IQ will not be accepted by the system.

Hotlines are available in many countries to handle queries about the VDO Dayton multimedia systems. Up-to-date telephone numbers can be found in the accompanying info sheet.



VDO Dayton on the Internet: www.vdodayton.com

Subject to technical modifications and errors.

IMPORTANT NOTES

-  Installation may only be carried out by trained specialists!
-  Observe all quality standards of the automobile industry!
-  Fire hazard! When drilling pay attention to the location of cable harnesses, tank and fuel pipes!
-  Never drill into car parts which are load bearing or are important for safety reasons!

When installing components in the interior of the car remember the following:

-  The driver's field of vision must not be obstructed!
-  Increased risk of injury in accidents! Do not mount components in an area where the air bag will inflate or where head or knees could impact in the event of an accident!
-  Installation may only be made in vehicles with 12 V board voltage and negative pole on car body. Installation in unsuitable vehicles could result in malfunction, damage or fire!

Checking the scope of delivery, ill. 1

- 1 Navigation computer with mounting sleeve and 2 mounting hooks
- 2 Monitor, monitor connector with cable, monitor holder with mounting plate, double-sided self-adhesive tape and 4 screws
- 3 IR remote control with holder
- 4 Signal cable
- 5 Power supply cable
- 6 GPS antenna with metal plate and cable
- 7 Mounting brackets and installation material
- 8 Language Loading Software CD
- 9 Instructions for use and mounting instructions

Take safety precautions

-  Before starting work disconnect the negative car battery terminal! When doing so make sure to observe manufacturer's safety instructions (alarm system, air bag, immobilizer, radio coding, etc.)!

Installing metal sleeve, ill 2 - 3

The computer can be mounted in a DIN radio opening of the vehicle with the supplied metal sleeve.

■ Please note before mounting, ill. 4:

- To ensure access to the CD opening a free space of at least 130 mm has to be in front of the navigation computer.
- For sufficient air circulation a free space of at least 50 mm has to be behind the navigation computer.
- The computer must be installed horizontally. Deviations of - 10 to + 30 degrees can be set in the "Mounting angle" menu (see "Initial operation"). Larger deviations may result in malfunctions.
- A stable connection to the car body is necessary for the computer to function correctly!

Insert metal sleeve into the DIN opening and press appropriate tags outwards with a screwdriver. Take care not to damage hidden parts in the dashboard.

Securing the computer using the mounting brackets

If installation of the navigation computer in a DIN slot is impossible or undesirable, it can be installed in alternative installation locations using the supplied mounting brackets (e.g., in the glove box, in the luggage compartment or under the seats).

For this purpose, both side-mounted catch springs must be removed from the navigation computer. The two Torx screws are required later for securing the mounting bracket.

■ Attaching mounting brackets, ill. 5

1. Position the brackets with the punched out tab at the right (or left) rear edge of the computer housing. It must be ensured that the tab fully engages with the sheet metal of the computer housing.
2. Swing the bracket forwards, applying pressure to the rear edge of the bracket so that it is flush with the computer housing.
3. Fasten the brackets to the computer housing using the existing Torx screws.

The computer can then be secured in the desired installation location using the screws supplied.

■ Suspended installation

If suspended installation is required for the computer (e.g., under the rear shelf), the mounting brackets can be attached to the computer in the reversed position.

Installing holder for the remote control

The remote control holder can either be screwed in place with the supplied angle bracket or glued onto the mounting surface with the supplied adhesive tape.

Note: Mounting temperature should be at least 15 degrees centigrade to ensure the full adhesive effect of the tape.

Installing GPS antenna, ill. 6

The GPS antenna can be mounted in the vehicle interior, for example on the dashboard or on the hatshelf. The antenna must have clear "view" of the sky.

-  In vehicles with metallic window tinting, the GPS antenna should be mounted in an area without tinting or outside on the vehicle body, for example in the plastic bumper.
 - Mount the antenna with the supplied double-sided adhesive tape.

Notes: To ensure perfect function please keep a distance of at least 10 cm to metall parts like window frame.

The mounting temperature should be at least 15 degrees centigrade to ensure the full adhesive effect of the tape.

Mounting monitor, ill. 7 - 8

 **Never install the monitor in an area where the head could impact in case of an accident!**

The monitor can be fastened with the supplied support either in normal or in suspended position. If it is mounted in suspended position, make sure that the display contents is rotated 180 degrees ("System settings" menu, option "Display").

■ Glueing the support

1. Fix the mounting plate with two Phillips head screws to the bottom of the monitor support.
2. Install monitor connector with the two countersunk screws to the monitor support, see ill. 8.
3. Slide monitor on the connector until it clicks into position.
4. Determine the mounting position of the monitor.
5. Remove the monitor from the support.

CAUTION: When removing the monitor from the support, always make sure to press the release key on the rear of the connector!
6. Clean the surface from grease and dust with methyl alcohol.
7. Remove protective paper from one side of the supplied adhesive tape and stick it to the bottom of the mounting plate.
8. Remove protective paper from the lower side of the adhesive tape and place the monitor support onto mounting surface and press firmly.

Note: Mounting temperature should be at least 15 degrees centigrade to ensure the full adhesive effect of the tape.

■ Screwing the monitor support

Screw monitor support without mounting plate directly in place with two appropriate screws.

■ Alternative mounting

To extend the mounting possibilities you can also mount the monitor without the supplied support:

Directly stick the monitor on the dashboard with double-sided self-adhesive tape.

For alternative mounting different supports are available in the high street.

 **Observe safety warnings concerning driver's sight and air bag inflation area!**

Completing electrical connections, ill. 9

Lay all cables carefully. Refer to the connecting diagram on the fold-out page at the end of the booklet and to the table below.

Power supply cable (ISO connector A):

Pin no.	Cable colour	Connection
A1	black/white	speedometer signal input, digital (long wire)
A2	white/yellow	back-up lights (reversing signal)
A3	white/brown	speedometer signal input, analogue (short wire)
A4	red	+12V permanent power supply, "terminal 30" (via cable fuse 10 A if necessary)
A7	violet	+12V switched, "terminal 15" (must not be interrupted during engine start)
A8	brown	negative battery pole, "terminal 31"

 **Only connect electrical signals to appropriate terminals in the vehicle.**

 **In the case of a direct connection to the battery secure the positive connection (red lead) with a 10 A fuse close to the battery (approx. 10 - 15 cm).**

1. Connect the free cable ends A4, A7 and A8 of the power supply cable  to suitable terminals in the vehicle according to the connecting diagram and the table.
2. Do not cut off unused cables! Wind them together and tie them back! They may be used later to install additional features.

■ Speedometer signal (ISO connector A):

Depending on the type of speedometer signal, either the digital (A1) or the analogue (A3) input must be selected. Check speedometer signal using an oscilloscope if necessary.

 **Never tap the speedometer signal from the ABS control!**

Digital (standard):

Connect the black/white cable A1 from cable harness to the tapping position of the speedometer signal. Location and connection details can be found in the vehicle specific information sheets (available as CD ROM).

Note: Many cars are supplied with the speedometer signal on one of the car radio connectors. Ask your car dealer for more information or call our hotline.

Analogue (for retrofitted speedometer senders and magnetic sensors):

Connect the short black/white A3 cable (directly at ISO chamber A connector) of the wiring harness to the output of the speedometer sensor or the magnetic sensor.

■ Further signals (ISO connector A):

Connect the white/yellow cable (A2) to a suitable connecting point of the back up lights (positive pole of the reversing lamp).

Connecting system components (ISO connector B)**Remote control holder RCD 3200 (accessory):**

Connect the Mini DIN plug of the remote control cable to the socket on the signal cable harness [4].

Loudspeaker (accessory):

Connect the loudspeaker (optional accessory ML 5000) with the 3.5 mm jack to the 3.5 mm plug of the signal cable harness [4].

The loudspeaker impedance should be between 4 and 8 Ohms.

Installing loudspeaker mute function (optional)

Connect the white/brown cable (B4) of the signal cable [4] to the mute input of the car radio.

■ TMC extension (ISO connector C2):

For system enhancement, an optional VDO Dayton TMC receiver can be connected to the navigation computer. For connection details see "Mounting the navigation computer".

■ Hands-free unit (ISO connector C1):

A VDO Dayton hands-free unit can additionally be connected to the navigation computer. For connection details see "Owner's manual and mounting instructions MG 3000 M".

■ Reproduction of voice messages through vehicle speakers

For reproduction of the guidance messages by the left front speaker of the vehicle you can connect an adaptor cable MA 1300 (optional) between the loudspeaker connector and the audio output of the navigation computer.

Mounting the navigation computer

1. Connect the GPS antenna.
2. Connect power supply cable [5] to ISO connector A' at the navigation computer.
3. Connect signal cable [4] to ISO connector B' at the navigation computer.
4. Insert yellow plug C1 of the monitor cable into the left chamber of ISO connector C1' at the navigation computer.
5. If you want to connect system extensions, take care to slide all the C plugs together before connecting them to ISO connector C' at the navigation connector.
 Green plug C2 of the TMC extension (optional): middle part (C2) of ISO connector C2'
 6. Screw the rubber buffer onto the rear support stud of the navigation computer and slide the computer into the metal sleeve until it clicks into position.

Caution: First mount the navigation computer firmly, then make the connection to the vehicle's power supply. Otherwise a wrong calibration of the gyro sensor may result.

Initial start-up

1. Reconnect the car battery.
2. Restore perfect functioning of the electrical system (clock, onboard computer, alarm system, air bag, immobilizer, radio coding, etc.).
3. Switch on the ignition.
4. Insert map CD into the navigation computer. Please note the instructions regarding activation of C-IQ map, travel and/or traffic info, see the operating instructions, Section "*C-IQ INTELLIGENT CONTENT ON DEMAND*" on page 12.
5. Insert batteries (not supplied) in the battery compartment of the remote control (see user manual of the navigation system).
If an RCD 3200 active holder (accessory) is used for the remote control, the remote control also works without batteries when placed in the holder.
6. Park the car so that the GPS antenna has free "visual contact" to the sky.
7. Start the engine.
The monitor display appears (user advice).
8. Confirm the user advice by pressing **OK** key on the remote control.
The start menu appears, initialization of the navigation computer then begins (duration between 2 and 10 minutes).

■ Setting mounting angle

In order to ensure perfect functioning of the system, the computer must be adjusted to the actual installation angle (e.g., in the dashboard).

1. Select the "Mounting angle" option from the "System settings" menu.
2. Depending upon the installation, set the angle to between - 10 and + 30 degrees.
The system does not differentiate between negative and positive angles. Thus, even for a mounting angle of, e.g. - 10 degrees, set a value of "10" in the menu.

Checking the car functions

 **Only check safety functions when the car is standing still or driving at low speed!
Always carry out checks in open areas!**

Check brake system, alarm system, lights, immobilizer, speedometer, trip computer, radio (coding) and hi-fi stereo, clock.

Checking the navigation functions

Check the following functions when the car is stationary:

Remote control (batteries inserted)

Press the keys on the remote control and check operation.

GPS reception

Enter a destination and select "Guidance". Call up the "GPS/Compass" information menu via the guidance screen (see operating instructions) and check the number of satellites. For a sufficiently exact location determination the number should be between 4 and 8.

Calibrating the system

For automatic calibration, perform a short test drive (approx. 10 minutes) on digitised roads. Change direction several times.

Drive through several intersections and monitor the current vehicle position in the "Car position" information menu. Once the displayed position agrees with the actual car position, calibration is complete.

Note: The system can also be calibrated without C-IQ contents activated. However, no directional information will be provided. The current vehicle location can then be checked in the emergency menu (see operating instructions, page 40).

Hotline

Hotlines are available in many countries to handle queries about the VDO Dayton multimedia systems. Up-to-date telephone numbers can be found in the accompanying info sheet.

Subject to technical modifications and errors.

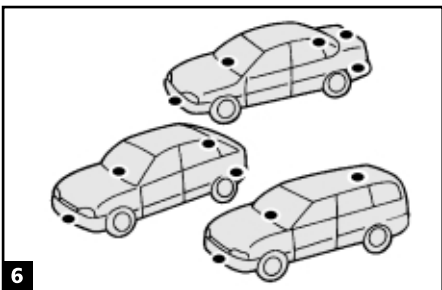
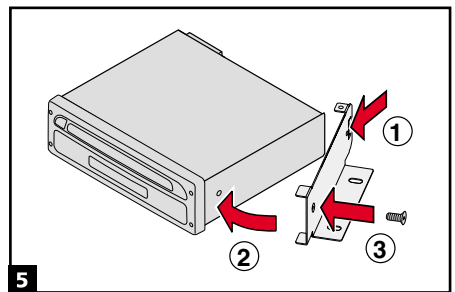
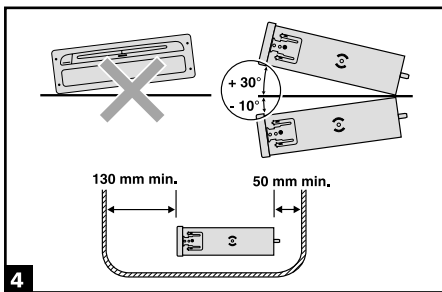
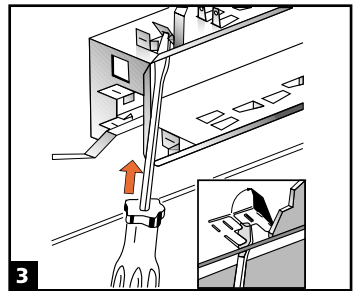
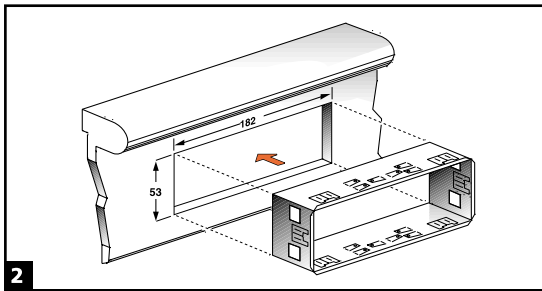
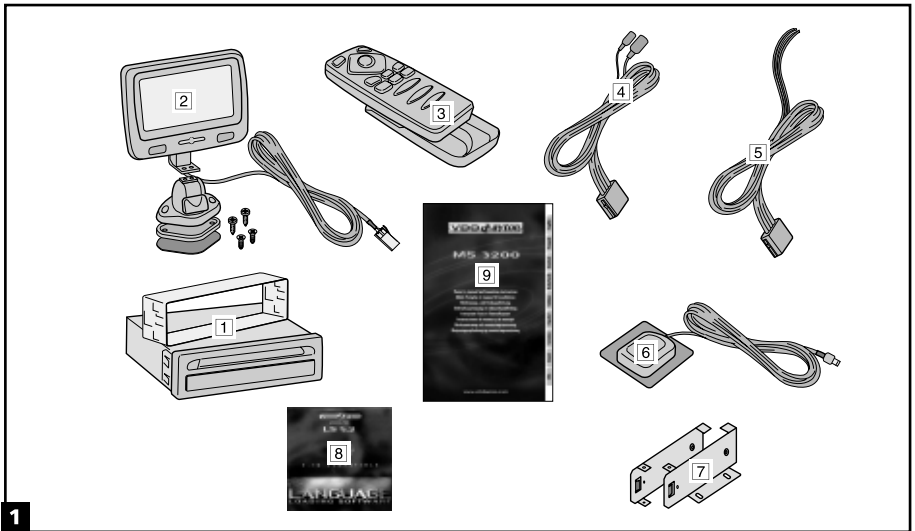

7

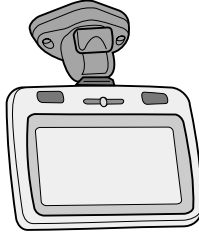
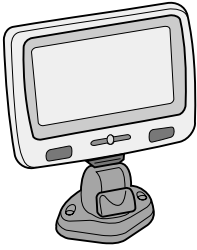

8

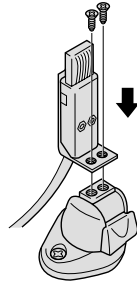

9

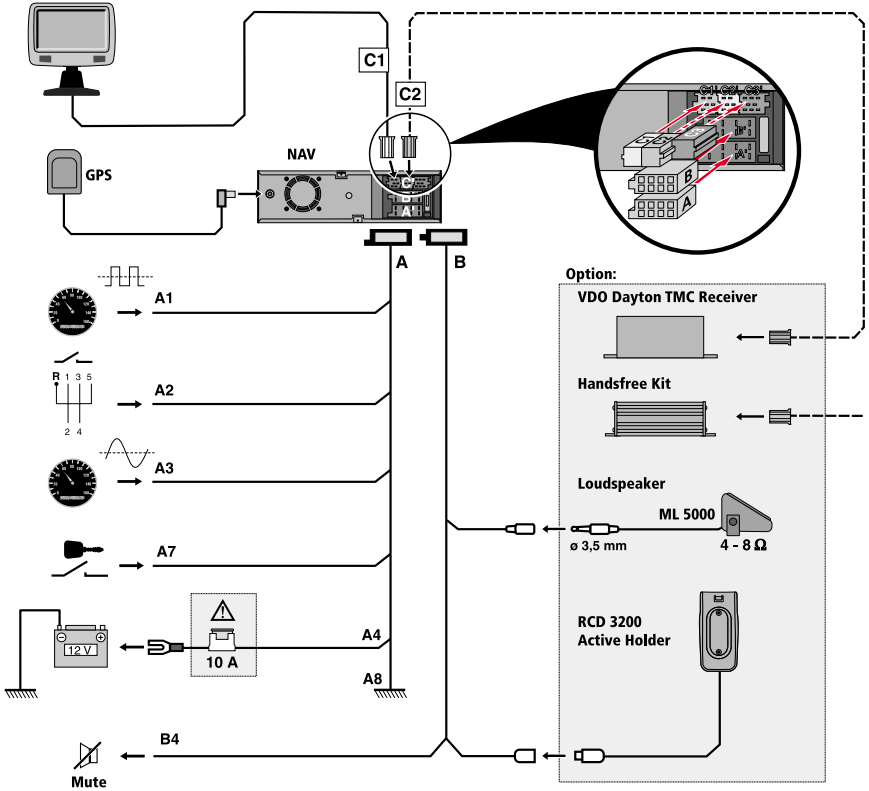



32509271

Car Multimedia Systems.



VDO Dayton. The Car Brand.