

THE NEW VALUE FRONTIER



Instruction manual • Mode d'emploi

GB/F

Finecam L4v

4.0 MEGA PIXELS 3.0X OPTICAL ZOOM

Finecam L3v

3.2 MEGA PIXELS 3.0X OPTICAL ZOOM

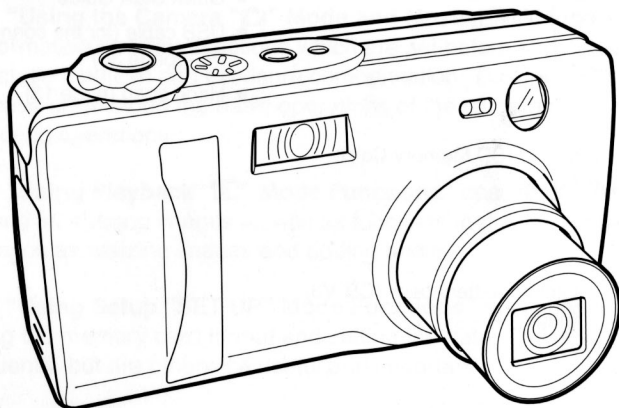

Please purchase "Secure Digital (SD) Memory Cards" or "Multi-Media Cards*" (MMC) for use with this camera. These cards are referred to in these User's Manuals as "Memory Cards."

* MultiMediaCard is a registered trademark of Infineon Technologies AG (Germany), licensed to MMCA (MultiMediaCard Association).

Faites l'acquisition de "Cartes Mémoire Secure Digital" (SD) ou de "Cartes MultiMedia*" (MMC) que vous utiliserez dans cet appareil. Dans le présent manuel, ces cartes sont appelées "Cartes Mémoire".

* MultiMedia Card est une marque déposée de Infineon Technologies AG (Allemagne), accordée sous licence à MMCA (MultiMediaCard Association).

Introduction
Introduction

Preparations of
Camera
Préparatifs
d'appareil photo

Basic
Operations
Démarches de
base

Shooting
Technique



SET UP

Appendix
Annexe

ENGLISH

FRANÇAIS

Introduction

Thank you for purchasing this Kyocera product.

The KYOCERA Finecam L4v and Finecam L3v are digital cameras equipped with a 3x optical zoom lens for high performance and high quality digital still photography.

For the operation of the camera, please read this User's Manual carefully and follow its instructions to assure proper use.

Check the Contents

Make sure all the items below are included in the box.



Digital camera
"Finecam L4v" or
"Finecam L3v"

- User's Guide (this book)
- Quick Start Guide
- USB cable (for the connection to PC) (page 30)
- Hand strap (page 13)



Memory card (SD Memory Card)
(page 14)

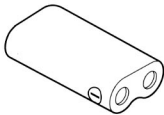

Lithium battery pack (CR-V3)
(page 14)



CD-ROM
(for the driver software)



How to Use this Manual

The section “**Introduction**” contains important information regarding the camera and this User’s Manual as well as precautions on handling the camera.

The section “**Preparation of Camera**” contains instructions on what to do before using the camera.

The section “**Basic Operations**” describes basic operations of the digital camera such as shooting, viewing, and erasing images. If you use a digital camera for the first time, read these sections carefully in order to learn how to use it properly.

The section “**Shooting Technique**” describes how to bring the camera into focus or how to take a picture using the viewfinder in order to use this camera perfectly.

The section “**Using the Camera “ Mode and Movie “ Mode Functions**” contains information on using functions which are set before shooting images. Such functions include the flash and exposure compensation. This section is intended for those who have understood the basic operations of the camera and have become used to shooting operations.

The section “**Using Playback “ Mode Functions**” describes how to use functions used for viewing images as well as functions that allow simple image processing such as resizing images and adding audio.

The section “**Using Setup “SET UP” Mode Functions**” describes functions, such as specifying the memory card format and setting the date. These functions may be used infrequently, but are otherwise useful and important.

The section “**Appendix**” contains a troubleshooting guide for solving problems with the camera and camera specifications.





















- The digital camera is referred to in this User’s Manual as “camera”.

* **Before You Begin...** This camera is an electronic device which uses a high-performance IC. The heat emitted from the IC may make the camera warm during use. It is not a failure.

Contents

Introduction	2
Check the Contents.....	2
How to Use this Manual	3
Handling Precautions	8
Functions of this Camera	11
Camera.....	11
System Around the Camera	12
Names of Parts	13
■ Attaching the Hand Strap.....	13
Preparation of Camera	14
1 Loading the Memory Card and Inserting the Battery Pack.....	14
Removing the memory card	15
Write Protect Switch (SD Memory Cards only)	15
The AA batteries may also be used.	15
2 Turning the Power ON.....	16
■ Battery indicator and replacing time.....	16
3 Setting the Date and Time.....	16
Basic Operations	18
Taking a Picture (Shooting Still Images).....	18
Holding the Camera Steady	20
LED Displays after Shooting	20
Shutter Release Button Half-way Down	20
Let's Shoot Movies too.....	21
Checking the Pictures (Playback of Images)	22
Checking Image Information	23
Movie Display	23
Display during Movie Playback	23
Erasing Unwanted Images	24
Using the directional keypad and execute button.....	25
When the Memory Card is Full.....	26
Connecting to a PC	27
Installing the USB Driver	28
Connecting the USB Cable to your PC	30
Viewing the Images on Your PC	32
Printing Digital Images with a Dedicated Printer	37
Shooting Technique	40
Shooting Images Using Focus Lock.....	40
Subjects that are Hard to Bring Into Focus	41
Shooting Images Using Zoom (optical zoom and digital zoom).....	41
Saving Power by Shooting Images Using the Viewfinder	42
How to Use the Display Button	43

Using the Camera “” Mode and Movie “” Mode

Functions	44
Using Flash Functions.....	44
What is red-eye phenomenon?	46
[ / ] Macro and Landscape Photography.....	47
Avoiding Camera Shake.....	48
What is Parallax?	48
[] Using the Self-Timer	49
[] Selecting Image Dimensions (Pixels).....	50
[] Setting Image Quality (File Compression).....	51
Recording Capacity Based on Image Dimensions (Pixels) and Quality	52
Guidelines for selecting image dimensions (pixels) and quality	52
[] Exposure Compensation	53
Guidelines for using exposure compensation	53
[WB] White Balance Setting.....	54
[] Shooting Movies with or without Audio.....	55
[ M]/[ M] [COLOR MODE] — Selecting Color, B/W or Sepia Mode.....	56
[ M][CHROMA] — Changing the Contrast.....	57
[ M][SHARPNESS] — Sharpening the Outline.....	58
[ M]/[ M][WB PRESET] — Setting White Balance Manually	59
[ M][AE MODE] — Selecting the Exposure Mode	60
[ M]/[ M][FOCUSING] — Selecting the Focus Mode	61
[ M][LONG EXP.] — Slowing the Shutter Speed.....	63
[ M][ISO] — Changing ISO Sensitivity to Shoot Subjects	64
[ M][METERING] — Selecting the Area to be Exposed	65
[ M][DIGITAL ZOOM] — Using Digital Zoom or Not.....	66
Using Playback “” Mode Functions	67
[MULTI] Multiple Image Playback	67
[RECORDING] Adding a Voice Message to an Image	70
[PROTECT] Protecting Images from being Erased.....	72
[ERASE] Erasing Individual Images.....	72
[ERASE ALL] Erasing All Images.....	73
[RESIZE] Resizing and Trimming Images.....	74
[ROTATE] Rotating Images	76
[AUTO PLAY] Automatic Playback	77
[SETTING PRINT] Digital Print Order Format (DPOF) Setting	78
A Useful Way to Erase Images Using the Protect and All Erase Functions	81

Using Setup “SET UP” Mode Functions.....	82
[BRIGHT CNTRL] Setting Brightness of the LCD Monitor	82
[INSERT DATE] Setting to Write the Date in the Image	83
[FORMAT] Formatting the Memory Card	84
[POWER SAVE] Saving Power by Turning Power Off Automatically	84
[MODE LOCK] Preserving the Mode Settings	86
[BEEP] Setting the Volume of the Electronic Beeps	86
[SHUTTER VOL] Setting the Volume of the Shutter Sound.....	87
[COLOR SELECT] Setting the Color of Menu Display	87
[START SCREEN] Selecting the Startup Screen.....	88
[REC REVIEW] Reviewing the Image Just after Shooting.....	89
[LANGUAGE] Selecting the Display Language.....	89
[FILE NO.] Resetting the File Number to 0001	90
[MODE RESET] Restoring Default Settings of Functions	91
Appendix	92
Troubleshooting	92
List of Menus and Icons Displayed on the LCD Monitor	95
LED Indication and Camera Status	98
List of Menu modes that can be locked and default settings	100
Optional Accessories	101
Pay attention to your selection of [LONG EXP.] and [ISO]	102
Specifications	103

FCC COMPLIANCE STATEMENT FOR AMERICAN USERS

DIGITAL STILL CAMERA CONTAX TVs DIGITAL



Tested To Comply With FCC Standards

FOR HOME OR OFFICE USE

FCC Statement

This device complies with Part 15 of the FCC Rules. Operation is subject to the following two conditions:

(1) This device may not cause harmful interference, and (2) this device must accept any interference received, including interference that may cause undesired operation.

NOTE

This equipment has been tested and found to comply with the limits for a Class B digital device, pursuant to Part 15 of the FCC Rules. These limits are designed to provide reasonable protection against harmful interference in a residential installation.

This equipment generates, uses and can radiate radio frequency energy and, if not installed and used in accordance with the instructions, may cause harmful interference to radio communications. However, there is no guarantee that interference will not occur in a particular installation. If this equipment does cause harmful interference to radio or television reception, which can be determined by turning the equipment off and on, the user is encouraged to try to correct the interference by one or more of the following measures:

- Change the direction of the radio or TV antenna. Move the equipment or the radio or TV. For example, if the equipment is to the right of the TV, move it to the left of the TV. Or, move the equipment farther away from the radio or TV.
- Plug the equipment into a different outlet. Do not plug your radio or TV into the same circuit as your equipment.
- Ensure that all expansion slots (on the back or side of the equipment) are covered. Also, ensure that all metal retaining brackets are tightly attached to the equipment.
- If these suggestions do not help, consult your equipment dealer or experienced radio/TV technician for help.

CAUTION

If you modify the camera in any way, without getting approval from KYOCERA CORPORATION, your camera may violate FCC regulations. Violation of FCC regulations may cause the FCC to void your right to use the modified camera.

Shielded cables must be used for this equipment to comply with the relevant FCC regulation.



For customers in Canada CAUTION

This Class B digital apparatus complies with Canadian ICES-003.

Cet appareil numérique de la classe B est conforme à la norme NMB-003 du Canada

Caution and Warning Symbols

These Operating Instructions feature the following caution and warning symbols to indicate items of special importance. Be sure to read the contents of these warnings carefully, and use the features correctly.

 DANGER	This symbol indicates procedures which have a high likelihood of resulting in death or serious personal injury if not followed properly.
 WARNING	This symbol indicates handling procedures which may result in death or personal injury if not followed properly.
 CAUTION	This symbol indicates procedures which may result in injury to the user, or physical damage to the product if not followed properly.

Handling Precautions

<Precautions for Operating the Camera>

 WARNING	<ul style="list-style-type: none"> ● If camera or batteries become hot, emit smoke or a burning smell, or display other abnormal symptoms, remove them from the camera immediately to prevent fire. When handling the batteries, take precautions to avoid being burned. ● Never attempt to disassemble or modify the camera, since you may receive a severe electric shock. ● Do not operate the electronic flash at close proximity to a person's eyes (especially those of an infant), since eye damage may result. ● Do not look through the camera directly at the sun or other strong light source, since your eyesight may be damaged. ● Do not attempt to take pictures while driving or walking, particularly when looking through the viewfinder or at the LCD monitor, since you may cause an accident. ● When taking pictures, remain aware of your surroundings and what is happening around you.
---	--

 CAUTION	<ul style="list-style-type: none"> ● Clean the camera well after using it at the beach or other locations subject to large concentrations of sand or dust. Salt air may promote corrosion of metal components and damage or short circuits in electronic parts, causing the camera to emit smoke or catch fire. Sand inside the camera may result in internal damage and operating malfunctions. ● If the camera is brought quickly from a cold place to a warm room, condensation may form on the lens and internal parts. Such condensation may result in damage or short circuits in electronic parts, causing the camera to emit smoke or catch fire. Whenever possible, avoid subjecting the camera to sudden changes in temperature, and if condensation occurs, turn off the camera power quickly and leave it off until all condensation is gone. ● This camera is a precision electronic instrument, and should be protected from impacts and falls that might cause damage to internal parts or the shorting of circuitry. ● When taking the camera overseas or using it to record important events, check its operating condition and take test pictures beforehand to confirm proper operation.
---	---

- This camera is not designed to be waterproof, and cannot be used in the rain or under water. If the camera should inadvertently be exposed to water, it should be taken quickly to a Kyocera/Yashica Service Center for inspection.
- Fingerprints or smudges on the camera's lens or light sensors may adversely affect the precision of the camera. If soiling occurs, use a piece of clean chamois or commercially available lens tissue to gently wipe away the smudge. Do not apply excessive pressure or touch the lens with any rough material. An air blower or lens brush may be used to remove loose dust or dirt from the lens.
- Clean the camera body by wiping with soft cloth. Never use benzene, thinner, or other volatile solvents or cleansers, since such substances will damage the body materials.
- Do not remove the Memory Cards while the card access LED is flashing.

- Interference may occur in recorded or played back images when the camera is used in areas subject to strong electromagnetic interference (e.g., near a television set or stereo speakers).
- Do not direct the camera lens directly toward the sun when shooting, since the CCD element may be damaged.
- Dropping the camera may cause damage to internal parts even though the camera may appear superficially undamaged. Always take the camera to a Kyocera/Yashica Service Center for inspection if it is dropped.
- Do not attempt to touch the insides of the memory card slot, since damage or malfunction may result.

Microcomputer Protection Circuit:

This camera incorporates a safety circuit to protect its microcomputer against strong external static electricity. Though rarely, it may fail to function because this safety circuit has come into action. In this case, turn off the camera's power, remove the batteries, reload them and use the camera again.

For best performance, we recommend the use of genuine Kyocera accessories. Kyocera is not responsible for any accidents or damage caused by the use of accessories made by other manufacturers or fashioned by the user.

Photographs taken of professional performances, exhibitions, displays, or copyrighted materials may be used only for your own personal enjoyment, and only with the consent of the copyright holders. Other use may constitute violation of applicable copyright laws. Be aware that some performances, exhibitions, or displays may impose restrictions on photographic or other recording even when the purpose of such recordings are personal enjoyment.

Test Photos and Warranties

Make it a practice to take test shots before beginning any important photography session, in order to confirm that images are being recorded properly. Kyocera will not be held responsible for failure of photographs to be recorded or transmitted to a computer as the result of any defects in recording media (Memory Cards).

<Storing the Camera>

 CAUTION	<ul style="list-style-type: none"> ● Store the camera in a well-ventilated location, avoiding damp or dusty areas, drawers or boxes containing mothballs, or in laboratories or other locations where chemicals are handled. Exposure to such chemical fumes can result in damage to the camera's circuitry, resulting in short circuits and causing the camera to emit smoke or catch fire.
---	---

- Do not place the camera in places that may be exposed to high temperatures for extended periods of time (the beach in summer, a closed car under bright sun, etc.). Such high temperatures may cause adverse affects or damage to the camera, batteries, or memory cards.
- Remove the batteries before storing the camera for extended periods of time, to prevent battery leakage and resulting damage.

<LCD Monitor>

 CAUTION	<ul style="list-style-type: none"> ● Strongly rubbing or pressing against the LCD monitor screen can cause damage or other malfunctions. If dirt or dust adheres to the surface, use a blower brush to remove the dirt. In the event of severe soiling, wipe gently with a soft cloth or chamois. In addition, never use organic solvent such as benzine or thinner. ● If the LCD monitor should become broken, take precautions to prevent personal injury from glass fragments. ● If the LCD monitor breaks and its liquid contacts your skin, quickly wipe away any remaining liquid and wash the skin with soap and water. If the liquid should enter the eyes, wash with clean running water for at least 15 minutes, then seek medical attention immediately.
---	--

- Due to the innate characteristics of LCD panels, a few pixels may appear permanently lighted or may not light at all. This is not a malfunction, and does not affect the recorded image in any way.
- The LCD monitor may appear difficult to see in some outdoor lighting situations.

<Precautions for Handling Lithium Battery Pack>

*Lithium battery pack = Manganese dioxide lithium battery pack(CR-V3).



- Battery performance will be reduced temporarily in low temperatures. If you are shooting in cold weather, keep the camera warm inside your jacket and take it out only when needed. Battery performance reduced by cold temperature will return to normal under normal temperature conditions.
- If the “⊕” and “⊖” poles of the battery are soiled with sweat or grease, poor contact will result. Wipe both poles clean with a dry cloth before use.
- Bring spare battery with you, if you are going on a long trip.
- Do not throw used battery into a fire and do not charge, short, disassemble or heat them because it is dangerous.
- The camera does not operate if the battery is loaded with “⊕” and “⊖” ends wrong.
- The lithium battery (CR-V3) can not be recharged.
- Keep the battery out of reach of children.



- The SD logo is a registered trademark.
- Microsoft and Windows are registered trademarks of Microsoft Corporation in the United States and/or other countries.
- Macintosh, Mac OS, QuickTime, and the QuickTime logo are registered trademarks of Apple Computer, Inc.
- PRINT Image Matching is trademark of Seiko Epson Corporation. The PRINT Image Matching logo is a trademark of Seiko Epson Corporation.
- USB DIRECT-PRINT is trademark of Seiko Epson Corporation.
- All other corporate and brand names are the registered trademarks or trademarks of their respective owners.

PRINT Image Matching

This product supports PRINT Image Matching II. When used in combination, PRINT Image Matching II enabled digital still cameras, printers and software help photographers to produce images more faithful to their intentions.

USB DIRECT-PRINT

- This digital camera supports the USB DIRECT-PRINT function and can directly be connected to the printer supporting the USB DIRECT-PRINT by a USB cable. After that, you can select an image on the monitor of the digital camera and operate the monitor to start printing.

Functions of this Camera

Shooting

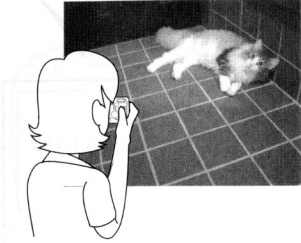

Playback

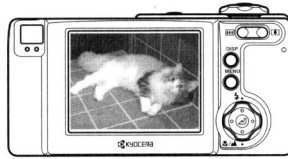

Connecting to a PC

Connect the camera to a PC using the supplied USB cable. Depending on the operating system, you need to install the USB driver. In this case, install the USB driver first, then connect the camera to a PC. Otherwise, you cannot install the USB driver correctly. For details, refer to page 27.

Saving images on the hard disk drive or CD-R



Saving images as background on the desktop

Sending images by e-mail

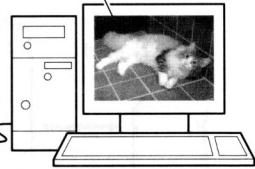

Editing images using image-editing software

Digital Print

Printer

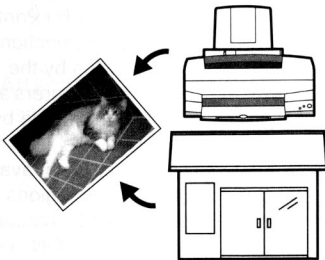
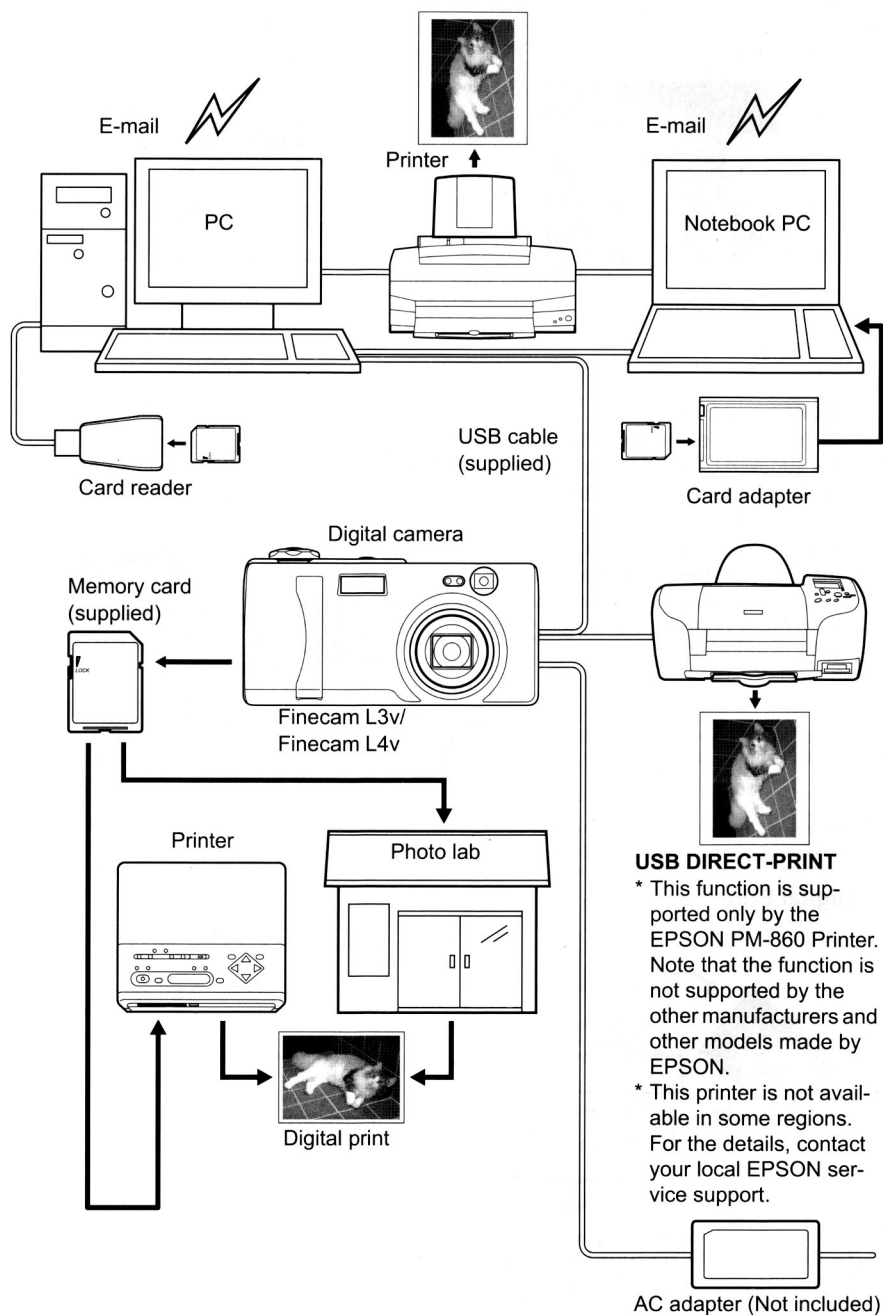

Photo lab

* You can e-mail digital images or take the memory card to a photo lab for printing just as ordinary films. Ask about services at the photo lab.

System Around the Camera



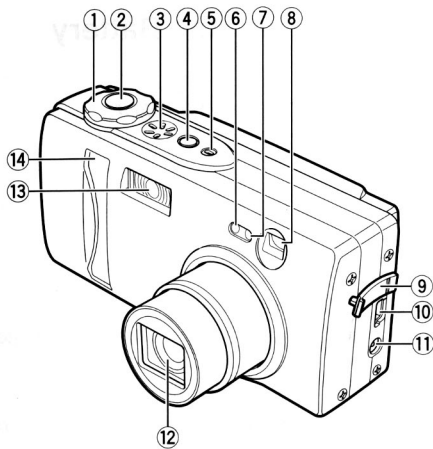

Names of Parts

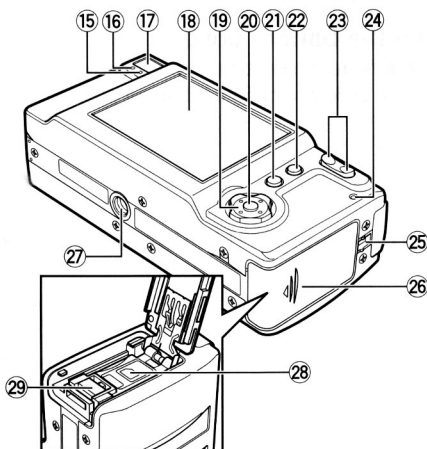

- ① Mode select dial (page 16)
- ② Shutter release button (page 19)
- ③ Speaker
- ④ POWER button (page 16)
- ⑤ Microphone (page 70)
- ⑥ Self-timer LED (red) (page 98)
- ⑦ Light sensor
- ⑧ Viewfinder
- ⑨ Connector cover
- ⑩ USB connector (page 30)
- ⑪ Power supply input socket
- ⑫ Lens/lens cover
- ⑬ Flash (page 44)
- ⑭ Front illumination (page 98)



- ⑮ Caution LED (red) (page 99)
- ⑯ Standby LED (green) (page 99)
- ⑰ Viewfinder (page 42)
- ⑱ LCD monitor (page 95)
- ⑲ Directional keypad (Up/Down/Left/Right) (page 25)
- ⑳  button (page 25)
- ㉑ MENU button (page 24)
- ㉒ DISP. button (page 43)
- ㉓ Zoom buttons ( wide-angle,  telephoto) (page 41)
- ㉔ Memory card access LED (orange) (page 99)
- ㉕ Strap lug
- ㉖ Memory card door (page 14)
- ㉗ Tripod socket
- ㉘ Battery cover (page 14)
- ㉙ Battery cover release lever

■ Attaching the Hand Strap

Attach the supplied hand strap as shown.

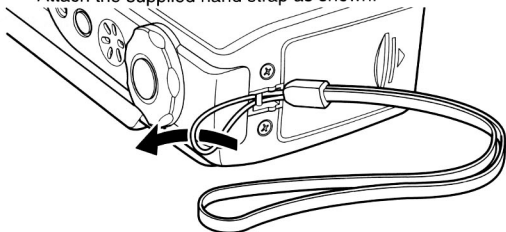

Preparation of Camera

I Loading the Memory Card and Inserting the Battery Pack

1



Open the memory card door.

Slide the memory card door and open it.

2

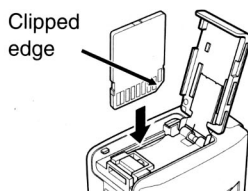

Insert the memory card.

Make sure the label side is toward the LCD monitor side.

Slide in the card until it stops with a secure click.

- Do not attach a seal, etc. on the memory card.
If you do so, you may not be able to remove the memory card.

3



Open the battery cover.

Put your finger on the battery pack cover release lever and slide it to open the battery pack cover.

4

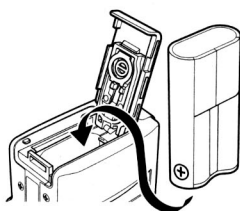

Insert the supplied lithium battery pack (CR-V3).

Make sure of the direction of the + and - of the battery.

5



Close the card cover and the battery cover.

- ① Close the card cover. (Then the battery pack cover closes at the same time.)
- ② Slide the card cover and lock it.

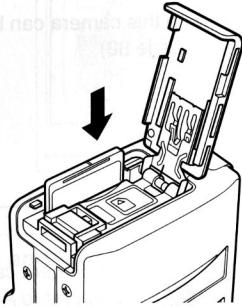
Removing the memory card

Push the memory card once so that the card comes out. Then pull out the card.

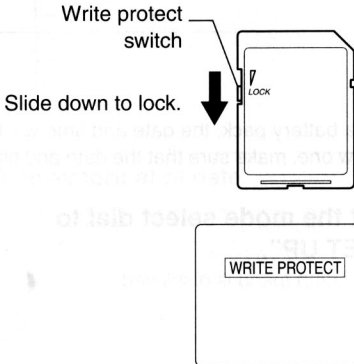
Write Protect Switch (SD Memory Cards only)

SD Memory Cards are provided with a write protect switch. When this switch is moved downward, further recording on the card is disabled and any images and data already on the card are protected.

While the card is write-protected, shooting or erasing images are disabled and the "WRITE PROTECT" will be displayed on the LCD monitor.

The AA batteries may also be used.

You can also use 2 nickel metal hydride rechargeable battery and 2AA nickel batteries other than the supplied lithium battery pack (CR-V3).

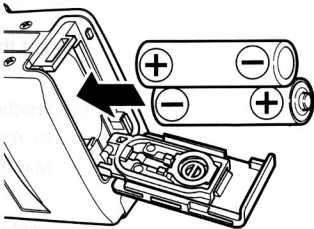

- In comparison with the supplied CR-V3, the recording capacity and playback time will be shortened by using the batteries above.
- Alkaline batteries and manganese batteries have low electric capacity to use for the camera. If they should be used, their state may improperly be detected, causing a sudden malfunction of the camera.

2 Turning the Power ON

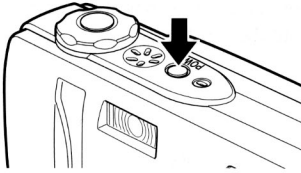

Press the POWER button.

- The picture you take with this camera can be set as the startup screen. (page 88)

■ Battery indicator and replacing time



Fully charged



Half consumed



Remaining power is low. Replace the battery pack soon.



The camera cannot be operated. Replace the battery pack.

3 Setting the Date and Time

If the camera has been left for a long time without a battery pack, the date and time will be reset. When you replace the battery pack with a new one, make sure that the date and time are correct.

1

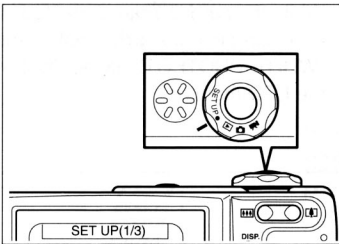

Set the mode select dial to "SET UP".

The setup menu is displayed.

2 Set the date and time.

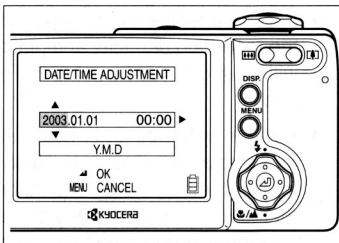

① Press Down on the directional keypad to select [DATE], then press Right on the directional keypad.

② Use the directional keypad to set the date and time.

- Press Left or Right on the directional keypad to move the cursor to Year ↔ Month ↔ Day ↔ Hour ↔ Minute ↔ Display format*.

- Press Up or Down on the directional keypad to change each value and the display format.

For Display format of date, see page 17.

3

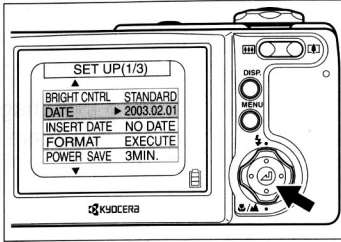

When the setting is completed, press the **M/Δ** button.

Date and time must be set.

```

┌─── 100KCBOX
│   ├── KIF_0001.jpg 2003.8.2
│   ├── KIF_0002.jpg 2003.8.2
│   ├── KIF_0003.jpg 2003.8.7
│   ├── KIF_0004.jpg 2003.8.15
│   └── ⋮

```

When a picture is taken, the digital camera saves image data to the memory card with its date and time information. As shooting date and time are saved, it is practical to organize image data in an album, etc. on your PC.

Display format of date

Format	Example
Y.M.D	2003.07.21
M.D.Y	07.21.2003
D.M.Y	21.07.2003

You can select the display format (order of year, month and date). There are 3 types. When [INSERT DATE] is set to "ON", the date is shown in the format which was selected in the date setting. (page 83)

Basic Operations

(For First-time Digital Camera Users)

Shoot images → **View** images → **Erase** unwanted images

These are the basic operations of a digital camera.

Please learn how to use this digital camera by shooting some trial images first. In addition, try to enjoy the special functions for the digital camera. For example, process images using the PC or print the digital image.

Taking a Picture (Shooting Still Images)

1 Setting the Mode to “📷” Camera Mode

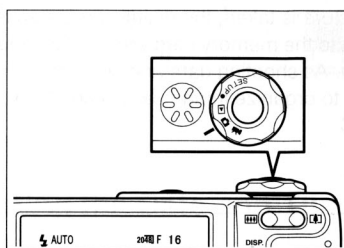

Set the mode select dial to “📷” then press the “POWER” power button to turn on the camera's power.

After the start screen is displayed, the date is shown for approximately 3 seconds. Make sure that the date is correct.

2 Compose your picture for the subject.



Compose your picture while watching on the LCD monitor.

- Take care of camera shake.

See also:

For “Camera shake” see page 48.

“Holding the Camera Steady” (page 20)

“Saving Power by Shooting Images Using the Viewfinder” (page 42)

Press the “ ” button to enlarge the subject and the “ ” button to reduce the size of the subject.

“Shooting Images Using Zoom (optical zoom and digital zoom)” (page 41)

3 Check the exposure and bring the camera into focus.

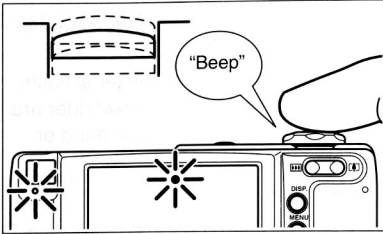

Lightly depress the shutter release button halfway to set exposure and focus. Pressing the shutter release button halfway down (Seepage 20.)

When exposure and the focus are properly set: The electronic beep is heard and the standby LED and focus mark come on.

When exposure and focus are not set:

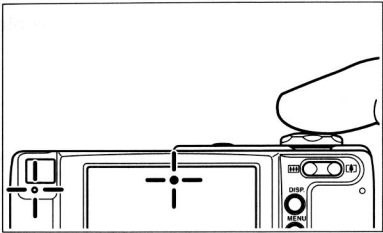

The standby LED and focus mark are flashing and no electronic beep is heard.

- Repress the shutter release button halfway down or use the focus lock to set exposure and focus properly.

4 Take a picture.

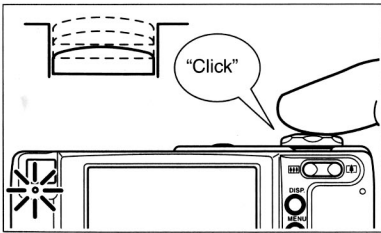

Fully depress on the shutter release button to take the picture; the shutter sound is heard and recording of the image begins.



When the standby LED goes off, the shooting is completed.

Holding the Camera Steady

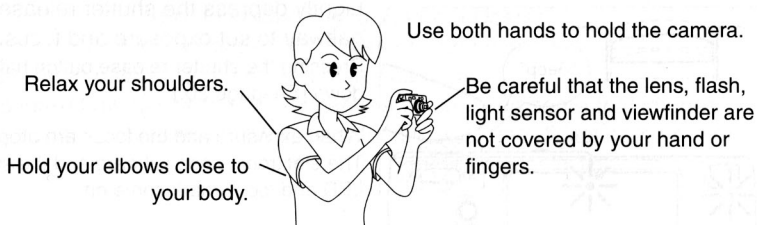

LED Displays after Shooting

When the caution LED and card access LED flash after shooting, the messages to be noted are as follows:

For the LED display, see page 98

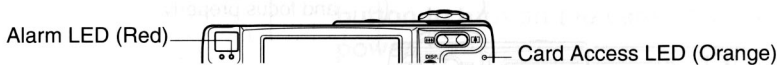

If the card access LED flashes after shooting, the images are being recorded into the memory card.

Do not open the memory card door or remove the memory card. Doing so may cause damage to the data. (You can take pictures while LEDs flash after shooting.)

If the caution LED flashes after shooting, the flash is being charged. Wait until the caution LED goes before taking the next picture.

Shutter Release Button Half-way Down

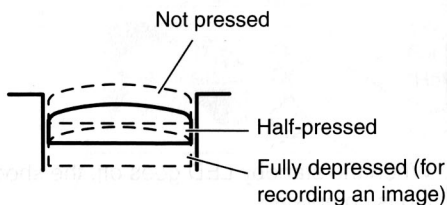

When the shutter release button is pressed, it will stop partway in its travel. In this semi-depressed position, the camera sets exposure and focus for shooting. When the shutter release button is fully depressed, the picture is taken and recorded.

Let's Shoot Movies too

1 Set the Mode to “” movie mode.

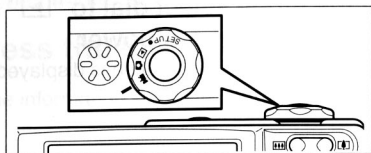

Set the mode select dial to “”, then press the **POWER** button to turn on the camera power.

2 Compose your picture and bring it into focus.

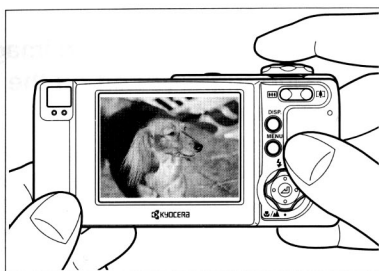

- ① Compose your picture while watching the LCD monitor.
- ② Press the shutter release button halfway to bring the subject into focus.

- The camera controls the exposure in recording according to the surrounding brightness.
- Focusing mark (green): Lights when the subject is brought into focus. (While the mark flashes the subject isn't brought into focus but recording can be performed.)

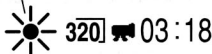

Remaining seconds for recording

3 Take a picture.

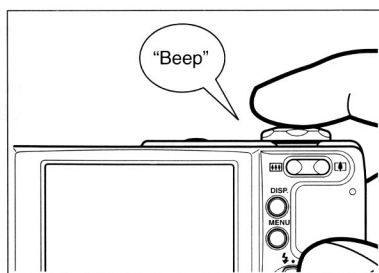

Depress the shutter release button fully to begin recording.

- Focusing mark (red): Lights while the moving picture is recorded.



Remaining seconds are displayed. (0 to 30 seconds for 320x240 size, 0 to 120 seconds for 160x120 size)

4

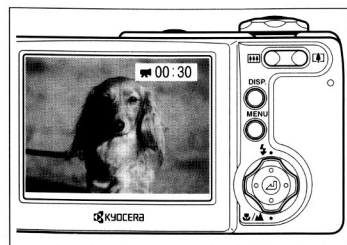



The movie recording ends automatically after 30 or 120 seconds.

- The zoom button can be used before recording, but it is disabled during recording. (page 55)
- To stop recording before 30 seconds have elapsed, press the shutter release button.
- When [PIXELS] is set to “160x120”, you can record a 120 seconds movie.

Checking the Pictures (Playback of Images)

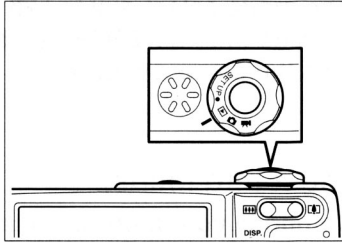
Set the Mode to “” playback mode.



Set the mode select dial to “” and turn on the camera power.

The image that you have taken is displayed on the LCD monitor.





You can check the recorded image by pressing Right or Left on the directional keypad.

Press Right: Forward direction
Press Left: Reverse direction

Playing Back a Still Picture



To enlarge or contract the image, press the zoom button..

-  Press the telephoto button to enlarge the image.
-  Press the wide button to contract the image (to the original size).
- After the image is enlarged, use the directional keypad to move the screen to the part of the image you wish to view.

Checking Image Information

You can check information such as aperture value, picture quality and shutter speed used for shooting.

Press the display button.

The information will be displayed.

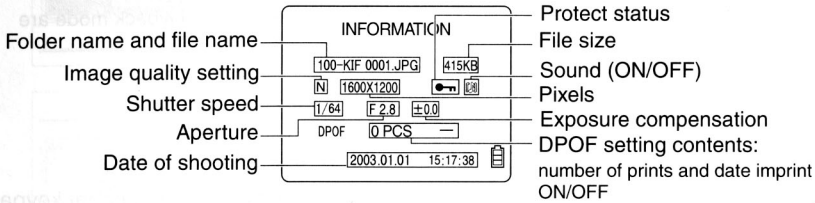

- By pressing Right or Left on the directional keypad, the images can be viewed in either forward or reverse direction.
- To delete the information, repress the display button.

Playing Back a Movie

Movie Display

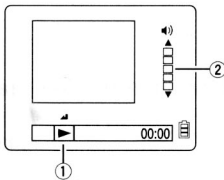

- 1 Press the button to start playback of the movie.
- 2 Press Up or Down on the directional keypad to adjust the volume.

Display during Movie Playback

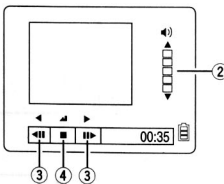

- 3 Pressing Right or Left on the directional keypad once pauses the picture and starts forward frame advance playback. Each time you press, a frame advances in forward direction.
- 4 Press the button to stop playback.

Erasing Unwanted Images

- 1 Set the Mode to “” playback mode and select “” erase.

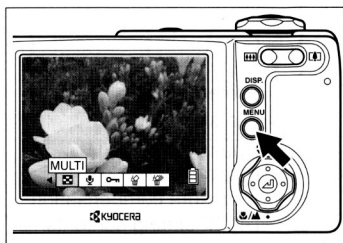

- ① Set the mode select dial to “” and turn on the camera power.
- ② Press the MENU button.
The menu icons for the playback mode are displayed.

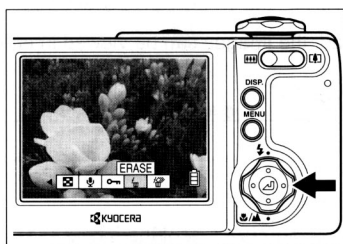

- ③ Press Right on the directional keypad to select [ERASE].
- ④ Press the  button.

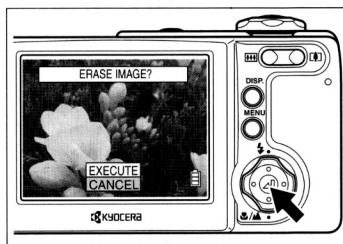

- 2 Select the image you want to erase.

Press Right or Left on the directional keypad to display the image to be erased.

- As an example, erase the displayed image.

3 Delete the image.

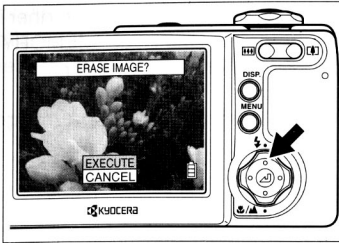

- ① Press Up on the directional keypad to select [EXECUTE].

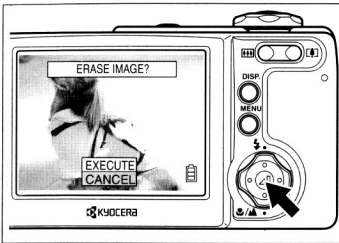

- ② Press the  button to erase the image. When an image is erased, the next image recorded on the card will be displayed. To erase other images, repeat steps 2 and 3.
- A protected image cannot be erased. See page 72.

4 Complete the operation.

Press the MENU button to exit the operation.

Using the directional keypad and execute button

To select the item from the menu icon or menu, use the directional keypad and execute button.

Directional keypad



In this manual, we call the center section as "execute button" and its surrounding area "directional keypad".

Execute button

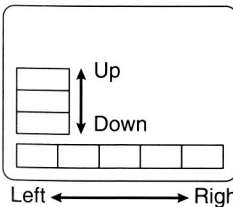

To select the menu, press Up, Down, Right or Left on the directional keypad and select the item. After that, press the execute button to set it.

When the Memory Card is Full

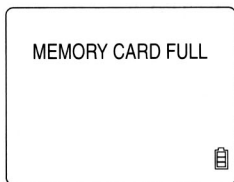

If it becomes impossible to record any further images on the memory card, the message "MEMORY CARD FULL" is displayed on the LCD monitor.

It is necessary to either replace the memory card with a new one or to save images to a PC and erase some of the images currently on the memory card.

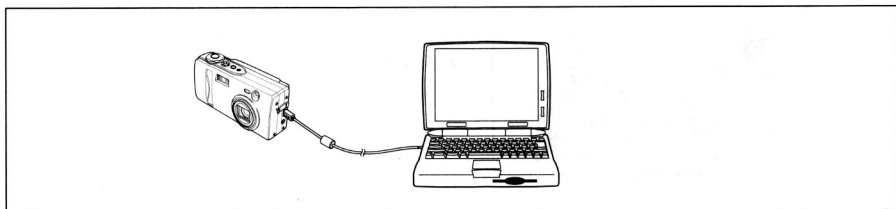

Use the supplied PC cable to save images to a PC. For details, see page 27.

Also, there are two ways to erase all images on a memory card: "Erase all" and "Format". For details on the "Erase all" function, see page 73. For details on the "Format" function, see page 84.

Connecting to a PC

If you connect the camera to a PC, the images shot can be viewed, copied, processed and sent by e-mail.

First check your PC environment or operating system.

If the operating system you are using is Windows 98/98SE or Mac OS 8.6

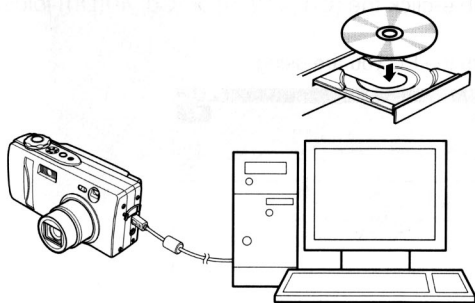

Install the USB driver, then connect the camera and the PC

⚠ Caution:

Be sure to install the USB driver before connecting the camera to the PC with the USB cable. Otherwise, the driver cannot be installed properly. If you have connected the USB cable first, see "Uninstalling the USB Driver and Remedies" on page 35 and take an appropriate remedy to your problem.

If the operating system you are using is Windows Me, Windows 2000, Windows XP*1, Mac OS 9.0 to 9.2 or Mac OS 10.0 to 10.2*2

*1: Windows 2000 should be Professional version and Windows XP should be Home Edition or Professional version.

*2: For the Mac OS, the OS X server should be excluded.

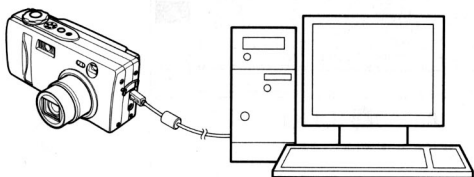

Connect the camera to your PC

- You don't need to install the USB driver.

* If the operating system you are using is not one of the above, or if it is one of the above, but is updated from a previous version, correct behavior is not guaranteed.

In addition, any PC requires the following installation.

- PC with a USB port (for connection)
- CD-ROM drive (for installing software)

Installing the USB Driver

The USB driver is included in the CD-ROM supplied with the camera.

- 1 Turn on the PC and start Windows or Mac.
- 2 Put the supplied CD-ROM into the CD-ROM drive on your PC or Mac.

For Windows 98 and Windows 98 SE users

- 1 In the [My Computer] window, double-click the [Cd_41(D:)] or [Cd_40(D:)] folder to open it.
 - The alphabetical letter (D) varies with the PC you are using.

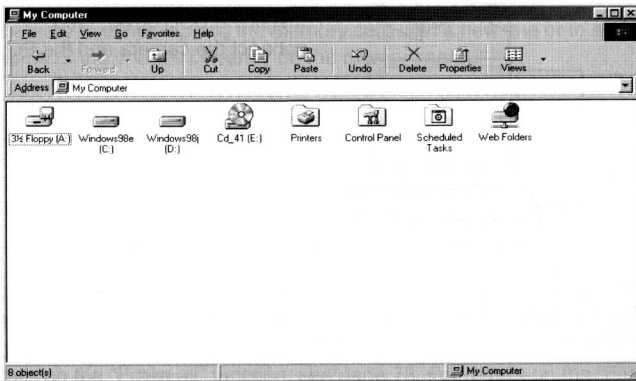

- 2 Double-click the [Eng] folder, then the [Disk1] folder to open it. Double-click the [Setup.exe] file to start installations. Follow the instruction and install the driver.

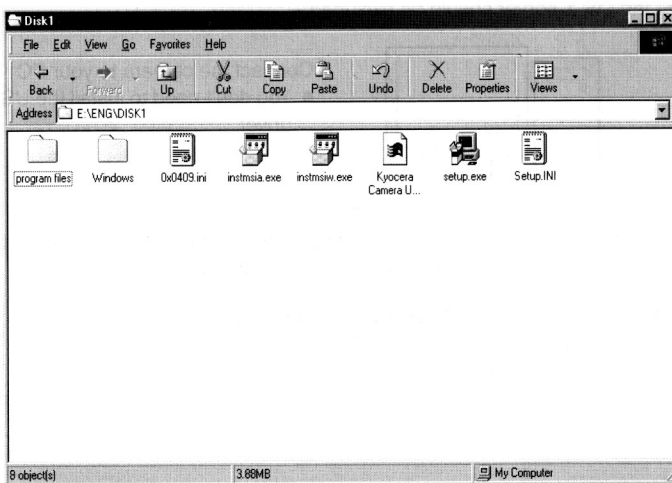

- 3 When a message “InstallShield Wizard Completed” is displayed, click “Finish” to stop the Wizard. After that, restart the computer.

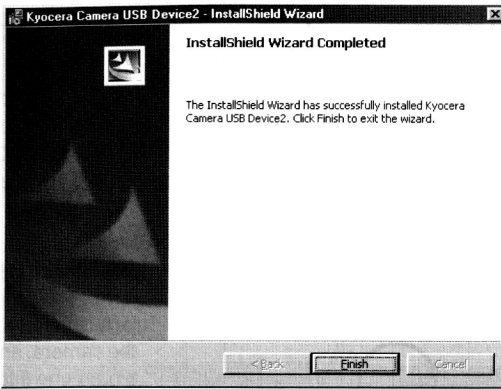

Caution:

If you failed in installation, uninstall the USB driver following the procedure shown in page 36 and reinstall it.

For Mac OS 8.6 users

- 1 Double-click the CD-ROM icon [CD_41] or [CD_40] displayed on the screen to open the CD-ROM window.

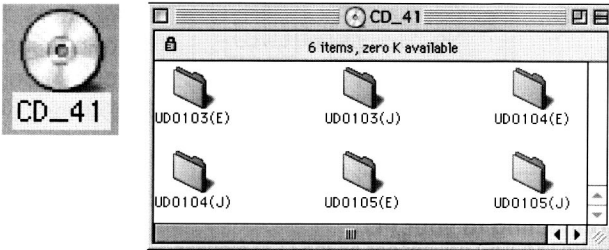

- 2 Double-click the [UD0103 (E)] folder to open it, then copy the following files to the folder [Extensions] in the system folder.

- * UD0103-USB Storage Driver
- * UD0103-USB Storage Shim (E)

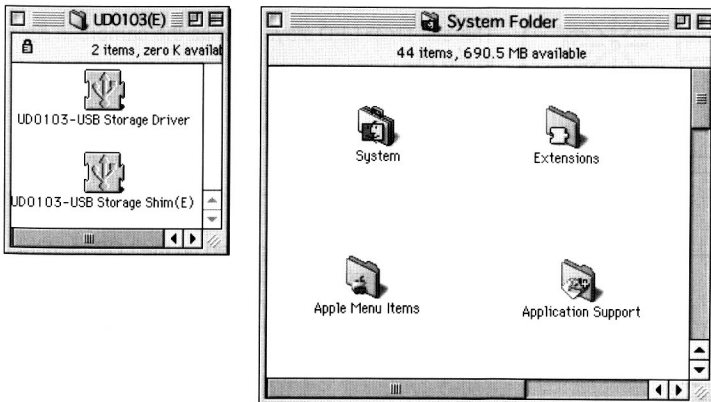

- After the copy completes, restart the computer. When the computer is restarted, the installation is completed.

Connecting the USB Cable to your PC

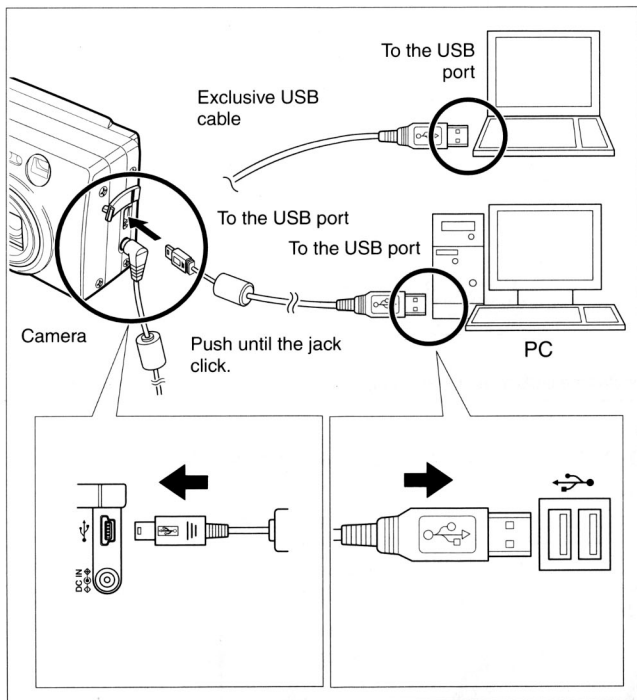

- Use the supplied USB cable to connect the camera to the PC.
 - Make sure of the sizes of the USB jacks. The smaller jack is inserted into the camera, and the bigger one into the PC.
- Turn on the camera power. If you can confirm the following steps, the connection is completed.

Camera's LCD after connecting to your PC

[PC MODE] will appear on the LCD monitor.

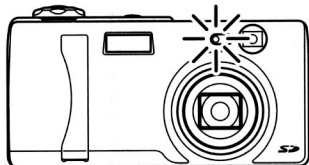
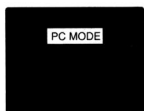

The self-timer LED stays lit while the camera is connected to the PC.

⚠ Caution:

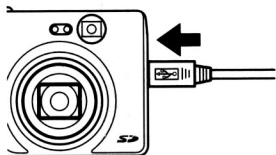

When [PC mode] is displayed on the LCD monitor of the camera but when [Removable Disk] or [Untitled Folder] icon does not appear on the PC display, check the secure connection for the USB cable.

PC display after connecting the camera

Windows: New [Removable Disk] icon appears in [My Computer] window.

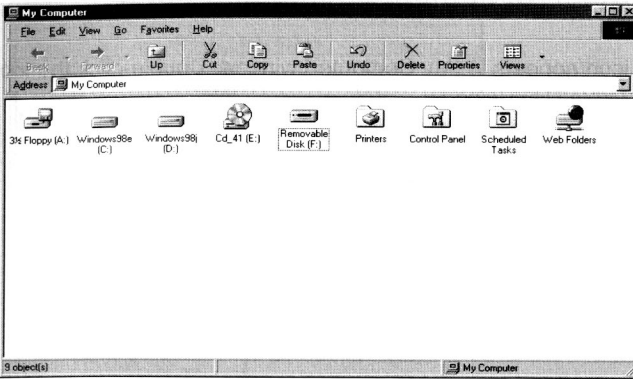

- The alphabetical letter in the parentheses varies with the PC you are using.
- For Windows XP users: The following Window will appear.

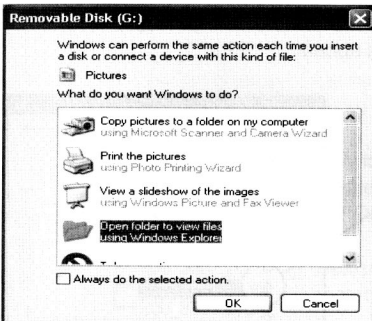

Macintosh: [Untitled Folder] icon appears on the Desktop.



Viewing the Images on Your PC

The software for viewing the images has already been installed on your PC (to replay the movies, you need to install QuickTime 4.1 or later).

For Windows users:

- 1 [Removable Disk] icon appears in [My Computer] window. Double-click the icon to open the [Removable Disk] window.

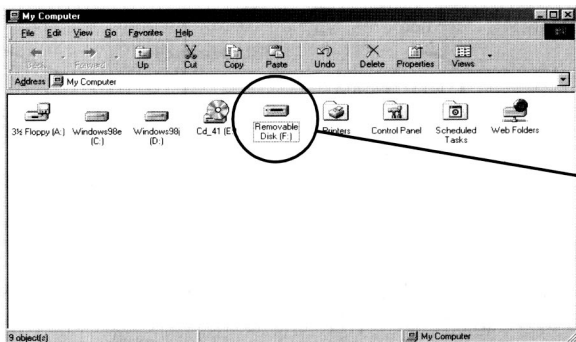

Double-click this icon.

- The alphabetical letter in the parentheses varies with the PC you are using.
- For Windows XP users: The following Window will appear.

If you select this icon, a folder containing image files opens.



Removable Disk

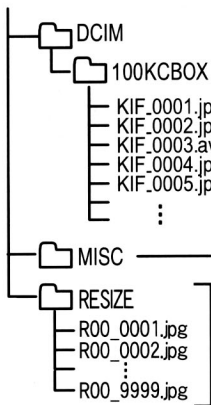

Still images/Movies
All the file names should be unique. If you delete an image, the name for the image will never be used again.

This folder will be created by setting (DPOF) print. (page 78)

Resized images will be recorded here.

- 2 Open the [100KCBOX] in the folder [DCIM] or folder [RESIZE], select an image you want to see and double-click it.

- The 100 in the folder [100KCBOX] means the number from 100 to 999. For the sequential number reset, see page 90.

For Macintosh users:

- 1 [Untitled folder] icon appears on the desktop. Double-click the icon to open it.

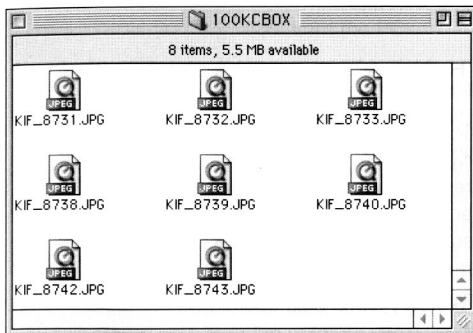

Untitled folder

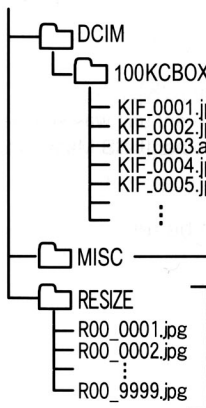
Still images/Movies

All the file names should be unique. If you delete an image, the name for the image will never be used again.

This folder will be created by setting (DPOF) print. (page 78)

Resized images will be recorded here.

- 2 Open the [100KCBOX] in the folder [DCIM] or folder [RESIZE], select an image you want to see and double-click it.

- The 100 in the folder [100KCBOX] means the number from 100 to 999. For the sequential number reset, see page 90.

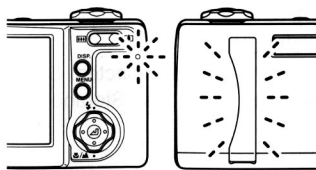

The card access LED and the front illumination flash while you access the data in the memory card or copying data.

- Under this condition above, do not disconnect the USB cable or turn off the PC or the camera. Failure to do so might damage the image data.

⚠ Caution:

- If you see an image on the display of your PC and rotate the image, it cannot be playback on the camera.
Be sure to copy the image before editing or rotating it.
- The batteries built in the camera will be consumed while the camera and your PC are connected. It is recommended only to copy an image in the PC folder during connection. Use caution to connect the camera and the PC for short time as possible.
- * If you connect the camera and the PC for a few hours, it is recommended to use an optional AC adapter AC-74L (page 101).

How to disconnect the USB cable

To disconnect the USB cable from the PC, follow the instructions below:

For Windows Me:

- 1 Double-click the "Unplug or Eject Hardware" icon on the task bar in the lower right corner of the desktop.
- 2 Select [USB Disk], then click [Stop].
- 3 Select [Kyocera E:], then click [OK].
 - If [Kyocera E:] won't appear, a different unit was selected. Click [Cancel] in this step, and return to step 2. Then select another [USB Disk].
 - * The alphabetical letter "E" in [Kyocera E:] varies with the PC you are using.
- 4 Click [OK] when a message appears.
- 5 Disconnect the USB cable from the PC and the camera.

For Windows 2000:

- 1 Double-click the "Unplug or Eject Hardware" icon on the task bar in the lower right corner of the desktop.
- 2 Select [USB Mass Storage Device], then click [Stop].
- 3 Select [Kyocera Finecam L4v USB device]*, then click [OK].
 - If [Kyocera Finecam L4v USB device] won't appear, a different unit was selected. Click [Cancel] in this step, and return to step 2. Then select another [USB Mass Storage Device].
 - * In some PCs, select [Kyocera Finecam L3v USB device]*.
- 4 When the message "[USB Mass Storage Device] can be removed safely." appears, click [OK].
- 5 Disconnect the USB cable from the PC and the camera.

For Windows 98/98SE:

Turn off the power, then disconnect the USB cable.

For Windows XP users:

- 1 Double-click [Safely Remove Hardware] icon on the [Task Bar] at the lower right of the desktop.
- 2 Select [USB Mass Storage Device], then click [Stop].
- 3 Select [Kyocera Finecam L4v USB device]*, then click [OK].
 - If [Kyocera Finecam L4v USB device] won't appear, a different unit was selected. Click [Cancel] in this step, and return to step 2. Then select another [USB Mass Storage Device].
 - * In some PCs, select [Kyocera Finecam L3v USB device]*.
- 4 The message "The 'USB Mass Storage Device' device can now be safely removed from the system." and the pop-up menu appear on [Safe To Remove Hardware] icon on the [Task Bar] at the lower right of the desktop, then click [Close] of the [Safely Remove Hardware] dialog.
- 5 Disconnect the USB cable from PC and the camera.

For Macintosh:

Click and drag the [Untitled Folder] folder on the Desktop to the garbage can. If you confirm that a message "Removing safely" or the like appears, or that the [Untitled folder] folder does not appear, disconnect the USB cable from the PC.

Cautions to be taken when the PC and the camera are connected

- Even though you resume your PC from the suspend or sleep mode, you may not be able to resume communication.
- When you need to modify an image, such as resizing or rotating, first copy the original image to your PC, then edit the copied image. DO NOT modify the original. If you modify the stored data on the memory card directly, you will not be able to view the image on the camera.
- DO NOT format the memory card using a PC. The memory card may not be able to be used on the camera.
- DO NOT delete or move image data directly from the memory card to a PC. If you want to delete any image data from the memory card, use the DELETE command on the camera.

Uninstalling the USB Driver and Remedies

For Windows 98 and Windows 98SE users, if you have connected the USB cable before installing the driver software, the driver software is not installed properly. In this case, take an appropriate remedy following the chart below.

Did you connect the USB cable and turn on the power of the camera before installing the driver software? Or did the camera stay off?

- 1 When the power of the camera is turned on
 - ① Carry out "Removing driver software".
 - ② Reinstall the driver software. (P.28)
 - If you install the driver software following the procedure on page 28, the window "Program maintenance" appears halfway.
Select "Restoration (P)" and proceed installation procedure.
- 2 When the power of the camera stays off
Remove the USB cable and install the driver software (P.28).

Removing the Driver

- 1 Turn on the PC and start Windows.
- 2 Connect the exclusive USB cable to the USB port on the camera and the USB port on your PC.
- 3 Insert the memory card into the camera and turn on the power.
- 4 Access the [Device Manager].
 - ① Right-click the [My Computer] icon, then click [Properties].
 - ② On the [System Properties] window, click the [Device Manager] tab.

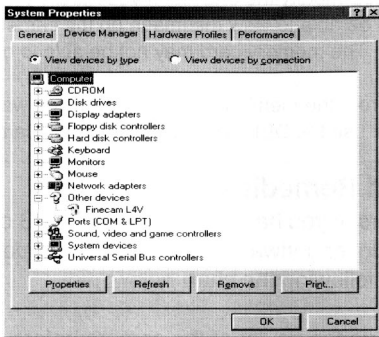

- 5 Click [Other Devices] and click [Delete] of [? Kyocera Finecam L4v] or [? Kyocera Finecam L3v] with “?” mark.
- 6 When the window confirming the deletion of the device appears, click [OK].

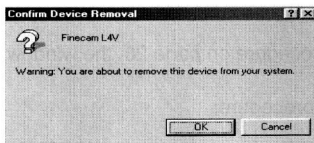

- 7 Turn off the camera power and disconnect the USB cable, then restart your PC. When the computer is restarted, the installation is completed.

Printing Digital Images with a Dedicated Printer

You can print images by inserting the memory card on which images were recorded into the printer or by connecting camera and printer with the USB cable.

- In the above case, you can use only supporting printers. Check the specification of your printer before starting the operation.

For printers supporting DPOF

You can print images as specified in [SETTING PRINT]. (page 78)

- Only available with printers which support DPOF. For details on the operation, refer to the instruction manual of the printer that supports DPOF.
- Even if the date print is set by DPOF, some printers may not print the date.

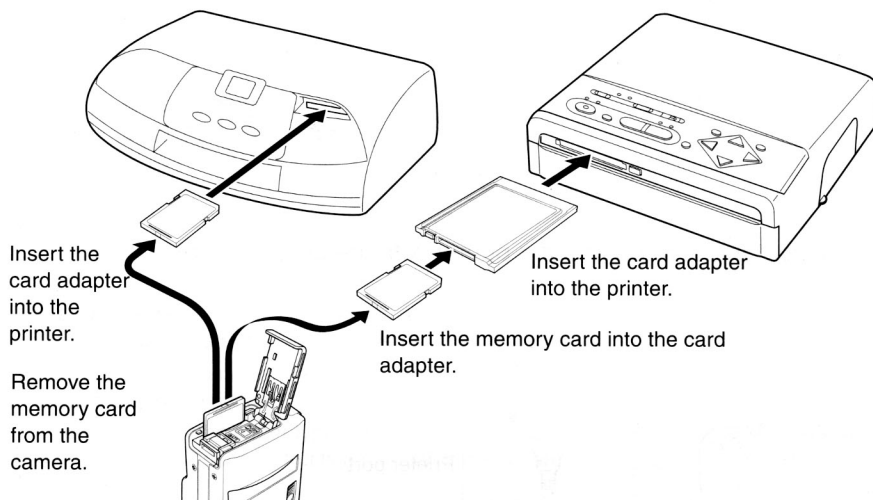

For printers supporting USB DIRECT – PRINT (only EPSON printers)

Through this function, you can connect the digital camera to the printer using the USB cable to print an image.

- The printer is not available in some regions.

“Single Print” : You can print the image one by one while checking the images displayed on the LCD monitor.

“DPOF Print” : You can print a few images together.

- This instruction manual describes how to use the camera. For use of the printer, refer to the instruction manual of the printer.
- The functions above are supported only by the Epson PM-860PT printer. Note that the other Epson models and printers made by other manufacturers don't support the print functions above. (As of the end of February in 2003)

Setting and Using the Printing Functions

1 To use the "DPOF Print", set the mode to print (DPOF) in the playback mode. (page 78)

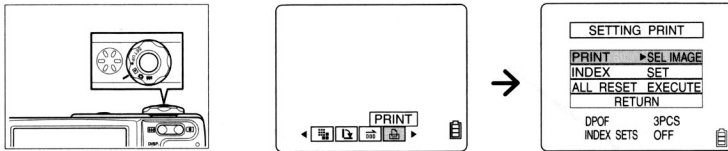

2 Connect the camera and the printer with the supplied USB cable.

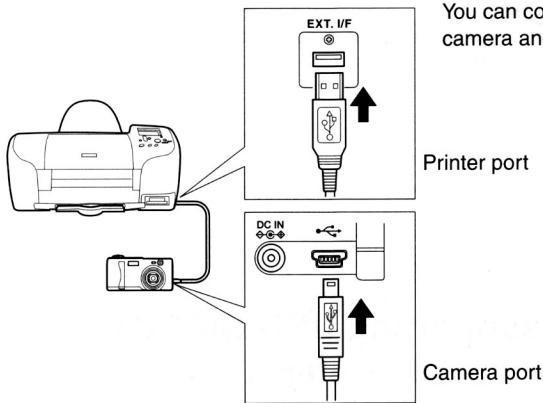

You can connect them when the powers of camera and the printer are ON.

The direct print menu will be displayed on the LCD monitor.

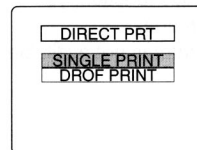

3 Select the direct print menu.

Press Up or Down on the directional keypad to select the menu, and then press the execute button.

To use [Single Print], select the image you want to print. Use the directional keypad to display the image you want to print. Select [EXECUTE] in the menu and press the execute button.

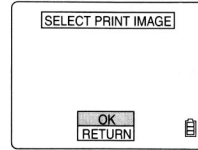

To use [DPOF PRINT], check the setting carried out at step 1. If the setting is correct, select "Execute" in the menu using the directional key pad and press the execute button.

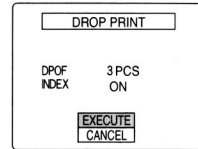

4 Set printing function.

Press Up or Down on the directional keypad to select the menu, and then press Right on the directional keypad. The submenu will be displayed.

Press Up or Down on the directional keypad to select the submenu and press the execute button.

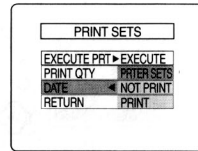

After the printing function is set, select [EXECUTE PRT] and press the execute button.

You can now set the paper type, image layout, etc. For details, refer to the instruction manual of the printer.

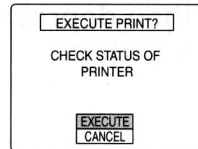

5 Print the image.

Check the paper set on the printer and printer settings. Press Up or Down on the directional keypad, select [EXECUTE] in the menu and press the execute button. Start printing.

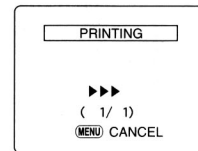

6 Image was printed.

The menu returns to the direct print menu.

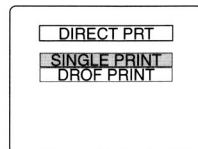

Shooting Technique

When you have learned in the section Basic Operation how to take a picture learn how to use this camera more effectively with the following techniques.

Shooting Images Using Focus Lock

Focus lock is a useful function when the subject you wish to bring into focus is not in the center of the LCD monitor, or when you wish to compose a picture away from the center. This function can also be used for subjects which are hard to bring into focus.

1 Align the focus frame with the subject you wish to bring into focus, then press the shutter release button halfway.

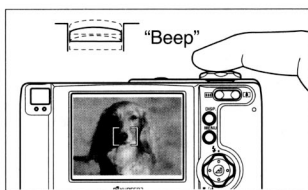

Focus has been achieved when you hear the beep and the standby LED lights.

- Focus and Exposure are locked (Focus Lock, AE Lock).

2 Move the camera while the shutter release button is half-pressed until you have the desired composition then depress the shutter release button fully to take the shot.

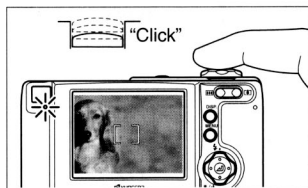

- Focus Lock and AE Lock are released when you remove your finger from the shutter button.

Subjects that are Hard to Bring Into Focus

The following types of subjects are hard to bring into focus.

Use the focus lock function to first focus on another subject at the same distance, then shoot the desired subject.

- Low contrast subjects
- Objects that consist of the same repetitive pattern
- Dark subjects
- Subjects made up of only horizontal lines
- Exceedingly bright or glossy subjects
- Any subject when there is a strong light source inside the viewfinder or nearby, or when there is intense light such as sunlight in the LCD monitor
- Multiple subjects at different distances from the center of the viewfinder
- Moving subjects

Shooting Images Using Zoom (optical zoom and digital zoom)

Using the zoom buttons is useful when you want to take a close-up of a flower you cannot get near to such as at a school presentation of field day.

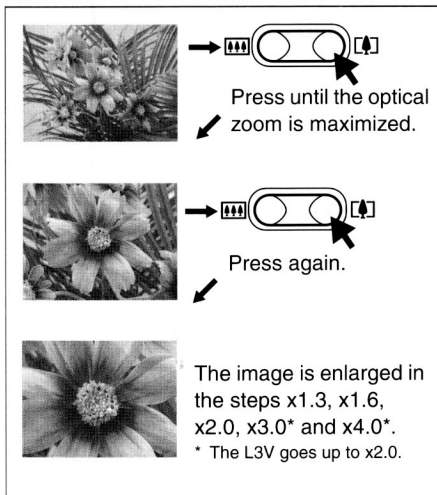
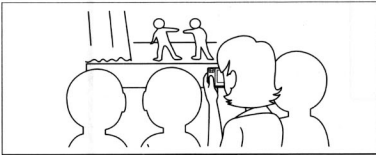

Compose your picture by pressing the “[]” (telephoto) button to enlarge the subject and the “[]” (wide-angle) button to reduce the size of the subject.

In addition to an optical zoom, this camera is also equipped with an electronically controlled digital zoom function for increasing the magnification.

Although image quality is degraded, it is possible to increase magnification up to 12 times (up to 6 times with the L3v) by using the digital zoom in combination with the optical zoom.

To use the two in combination, press the “[]” (telephoto) button until the optical zoom is maximized.

Release the button for an instant, then press the button again. Digital zoom will begin.

- You cannot use the optical zoom in the [] macro mode. Only digital zoom can be used.

Saving Power by Shooting Images Using the Viewfinder

It is recommended to turn off the LCD monitor and shoot images using the viewfinder when you wish to save battery power.

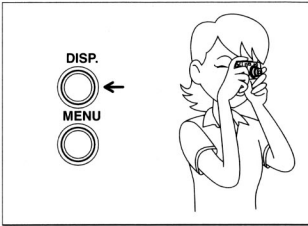





Pressing the “DISPLAY” button twice turns off the LCD monitor.

Shoot the image while paying attention to camera shake (page 48), field of view, and parallax (page 48).

See “Specifications” (page 103) for field of view.

How to Use the Display Button

When setting functions in  or  mode, icons representing other than default settings are displayed on the LCD monitor. Although this is convenient for checking current settings, it may be difficult to use during shooting. Press the "DISP" button to turn off icon displays if necessary.

When the camera is ready to shoot with the mode select dial set to  or  mode, pressing the "DISPLAY" button toggles the display of icons on the LCD monitor as shown below.

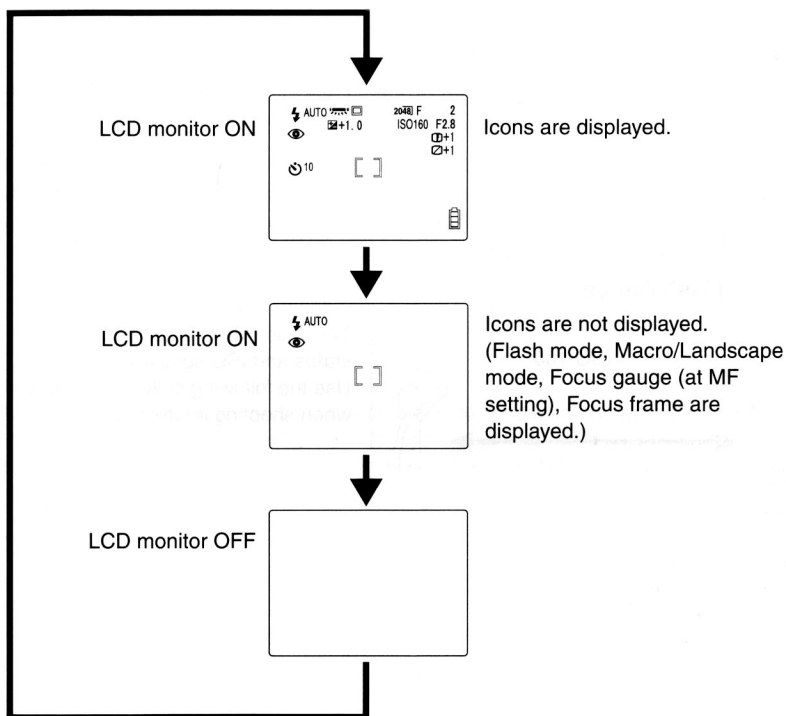

Using the Camera “📷” Mode and Movie “🎥” Mode Functions

This camera is equipped with many functions for shooting. Use these functions to shoot images in accordance with surrounding conditions.



Using Flash Functions

This camera is equipped with an automatic flash function that judges the surrounding light conditions and determines whether or not flash is necessary.

There are useful ways to use flash besides under dark conditions. This section describes how to use the flash modes in accordance with the scene to be shot, including using flash even when surroundings are bright and not using flash even when surroundings are somewhat dark.

Usable Flash Range

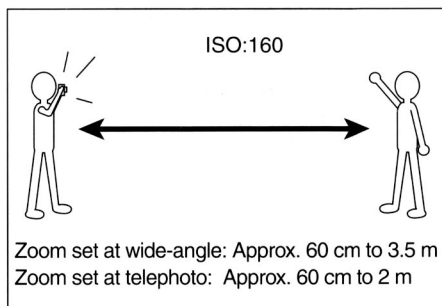

The flash range differs depending on zooming status and ISO sensitivity.

Use the following distances as a reference when shooting images. (page 64)

Types of Flash Modes

AUTO Auto Flash Mode (default)

The camera judges surrounding light conditions to determine whether or not a flash is necessary.

AUTO Red-Eye Reduction / Auto Flash Mode

When people’s eyes appear red in images, it is called “red-eye” phenomenon. (See “What is red-eye phenomenon?”) In this mode, the flash fires twice (once immediately before shooting and once at shooting) to help reduce the “red-eye”.

- No image is shot on the first flash, but an image is shot on the second flash. (After the first flash, take care not to move the camera and that no one in the shot moves.)
When the subject is dark, the slow shutter speed is selected (max. 1 second). Use a tripod to avoid camera shake.

Flash-off Mode

In this mode, the flash is disabled regardless of surrounding light conditions. This mode is effective when shooting an evening sunset or to preserve indoor atmosphere. Since a slower shutter speed may be used in this mode depending on the lighting, avoid camera shake by stabilizing the camera with a tripod.

Fill-in Flash Mode

In this mode, the flash fires regardless of surrounding light conditions. A portrait becomes darker when shooting with strong sunlight or with lighting coming from behind the people. In such cases, it is possible to take a clear shot of both subject and background.

AUTO Night Backdrop Mode

When shooting people in front of a night backdrop, this mode allows both people and the night backdrop to be shot clearly by slowing the shutter speed and using a flash. Since shutter speed is slowed, avoid camera shake by stabilizing the camera with a tripod.

AUTO Fill-Flash with Red-Eye Reduction Mode (When long exposure is selected)

When the long exposure (page 70) is selected and Up on the directional keypad is pressed, you can use the fill-flash with red-eye reduction mode.

This mode is appropriate for shooting people in front of the night backdrop. When this mode is used the shutter speed slows (2 sec., 4 sec., and 8 sec.) and a flash lights twice (before and after shooting), reducing red-eye phenomenon.



Using Flash Functions (continued)

What is red-eye phenomenon?

Red-eye is a phenomenon where the pupils appear red due to reflection (retina reflection) of light entering the eye.

Operation — setting to [📷]

- 1 Turn on the power and set the mode select dial to “📷”.

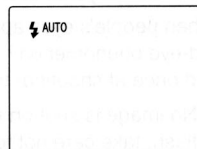

- 2 Press Up on the directional keypad. When [📷] appears, the setting is completed.

Each time you press Up on the directional keypad, the flash mode icon changes.

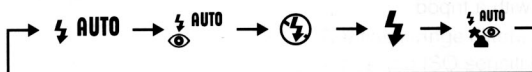
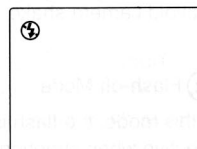

- This mode will be returned to the default setting [📷 AUTO] when the power is turned off. If you want to preserve the setting, set [MODE LOCK] to [ON]. (page 86)



[🌱/🏔️] Macro and Landscape Photography

Use the macro mode when taking pictures of small subjects such as flowers or coins from a close distance. You can take pictures from a distance as close as about 20 cm (from the surface of the lens). The landscape shooting mode is also available for taking pictures of distant scenery. In this mode, the lens is set to ∞ (infinity).

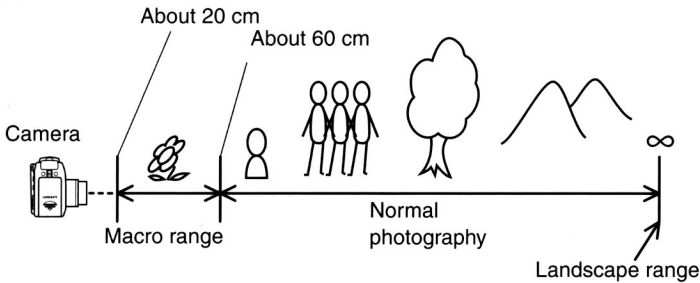

Operation — setting to [🌱/🏔️]

Turn on the power and set the mode select dial to “📷”.

- 1 Turn on the power and set the mode select dial to “📷”.

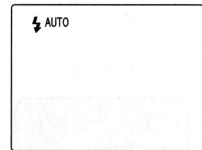

- 2 Press Down on the directional keypad. When [🌱/🏔️] appears, the setting is completed.

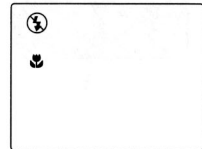

Each time you press Down on the directional keypad, the Macro/Landscape mode icon changes.

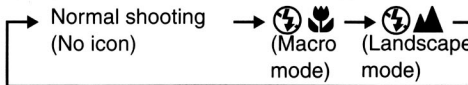

- In the macro mode, you cannot use the zooming control. The focus is fixed to wide focus area. (You can use a digital zoom.)
- In the Landscape mode, the flash does not fire.
- In the Macro mode, pressing Up on the directional keypad will set the fill-in flash mode.
- In the macro mode, if the LCD monitor is turned off and an image is shot, the LCD monitor turns on by pressing the shutter button halfway down. (When you press Up on the directional keypad or the menu button, the LCD monitor turns on.)

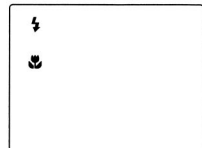

- The shooting mode will be returned to the normal mode when the power is turned off. If you want to preserve the setting, set [MODE LOCK] to [ON]. (page 86)

Using the landscape mode

The landscape mode is nice for shooting the low-contrast landscape such as sky.



Avoiding Camera Shake

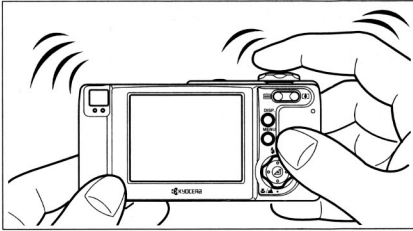

Shaking of the camera while taking a picture may cause the image to break up. This can occur easily when the shutter speed is slow or when taking macro shots. Since subject depth is extremely shallow when taking macro shots, even slight shaking of the camera while pressing the shutter release button can affect an image.

Camera shake can be avoided by stabilizing the camera with a tripod. In addition, use of a two-second self-timer [🕒2] is effective when taking macro shots.

What is Parallax?

<Shift in the composition of the shot>

Composition as viewed through the viewfinder



Image actually recorded

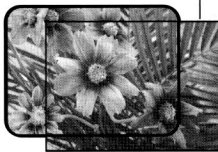

Parallax refers to the difference between the composition of a picture as viewed through the viewfinder and the image that is actually taken. Pay attention to the parallax particularly in macro shooting mode. When taking macro shots using the viewfinder, take the picture by estimating the parallax and slightly moving the camera to compensate. (Since the amount of parallax differs depending on the distance to the subject, check the parallax by taking trial shots.) Since there is no parallax when using the LCD monitor, we recommend that you use the LCD monitor as much as possible for shooting.



[🕒] Using the Self-Timer

The self-timer is a convenient function when you wish to include yourself in your pictures. The shutter is released 10 seconds or 2 seconds after pressing the shutter release button.

[OFF]	Normal shooting (default)
[🕒10]	Sets the 10 seconds timer.*
[🕒2]	Sets the 2 seconds timer.

* The self-timer [🕒2] is effective for preventing camera from shaking when taking macro shots.

Operation — setting to [🕒10]

- 1 Turn on the power and set the mode select dial to “📷” or “🎥”.
- 2 Press the MENU button to display the menu icons.

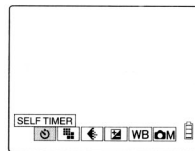

- 3 Press Left or Right on the directional keypad to select [🕒10] [SELF TIMER], then press the **▶** button.

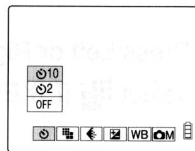

- 4 Press Up or Down on the directional keypad to select [🕒10], then press the **▶** button.

- 5 When [🕒10] appears, the setting is completed.
Press the MENU button to turn off the menu display for shooting.

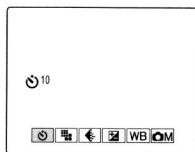

- The setting of the mode is turned off after a picture is taken. Set the mode again to take another picture using the self-timer.
- Use a tripod to stabilize the camera.
- To cancel the self-timer before the shutter is released, press the shutter release button.



📷 or 🎥

[📷] Selecting Image Dimensions (Pixels)

The pixels are measured as the number of dots that make up an image. Although picture quality increases with more dots, the size of the corresponding image files increases, thus reducing the number of images which can be recorded.

Select image dimensions (pixels) according to what the image will be used for.

Still images		Movies
Finecam L4v	Finecam L3v	Finecam L4v and Finecam L3v
2304x1728 (default)	2048x1536 (default)	320x240 (default)
1600x1200	1600x1200	160x120
1280x960	1280x960	
640x480	640x480	

Operation — setting to [1280]

- 1 Turn on the power and set the mode select dial to “📷” or “🎥”.
- 2 Press the MENU button to display the menu icons.

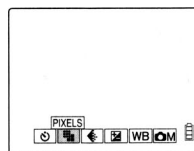

- 3 Press Left or Right on the directional keypad to select [PIXELS], then press the [OK] button.

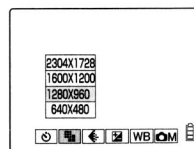

- 4 Press Up or Down on the directional keypad to select [1280x960], then press the [OK] button.

- 5 When [1280] appears, the setting is completed. Press the MENU button to turn off the menu display for shooting.

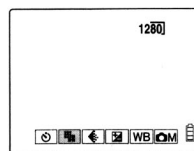

- Since the setting for this mode is saved even if the power is turned off, it is necessary to reset the setting depending on the scene and subject to be shot.



[] Setting Image Quality (File Compression)

Two compression ratios can be selected for the image quality: high compression [NORMAL] and low compression [FINE]. Although a lower compression ratio results in better picture quality, it also increases the size of files, thus reducing the number of images which can be recorded.



Select the image quality according to what the image will be used for.

[FINE]	Fine	Low compression ratio is applied when shooting.
[NORMAL]	Normal (default)	High compression ratio is applied when shooting.

- The setting is available only for still images. You cannot select a compression ratio for movies.

Operation — setting to [FINE]

- 1 Turn on the power and set the mode select dial to “”.
- 2 Press the MENU button to display the menu icons.

- 3 Press Left or Right on the directional keypad to select  [QUALITY], then press the  button.

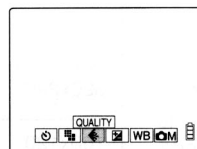

- 4 Press Up or Down on the directional keypad to select [FINE], then press the  button.

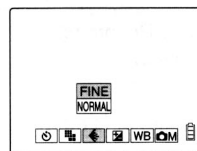

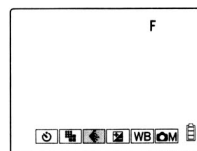

- 5 When [F] appears, the setting is completed. Press the MENU button to turn off the menu display for shooting.



- Since the setting for this mode is saved even if the power is turned off, it is necessary to reset the setting depending on the scene and subject to be shot.



Recording Capacity Based on Image Dimensions (Pixels) and Quality

	Image Dimensions (Pixels)	Quality* ¹	File Size* ²	Number of Images Recordable in a Memory Card* ³
 Camera mode (still images)	2304x1728 (L4v only)	F	About 2.0 MB	About 7 to 10
		N	About 1.0 MB	About 14 to 19
	2048x1536 (L3v only)	F	About 1.6 MB	About 9 to 12
		N	About 800 KB	About 17 to 24
	1600x1200	F	About 1.0 MB	About 14 to 20
		N	About 500 KB	About 27 to 36
	1280x960	F	About 660 KB	About 21 to 29
		N	About 360 KB	About 39 to 52
640x480	F	About 210 KB	About 67 to 85	
	N	About 140 KB	About 104 to 123	
 Movie mode	320x240	–	About 8.9 MB* ⁴	About 1 to 2* ⁴
	160x120	–	About 9.6 MB* ⁵	About 1 to 2* ⁵
Audio Recording Capacity		–	About 240KB* ⁶	–

*¹ F (fine) or N (normal)

*² File size differs depending on the subject conditions. Capacities are only given as general references.

*³ When using 16 MB Memory Card. Capacities are only given as general references.

*⁴ When recording a 30-seconds movie with sound.

*⁵ When recording a 120-seconds movie with sound.

*⁶ When recording a 30-seconds audio

Guidelines for selecting image dimensions (pixels) and quality

Select large image dimensions when you want to print a high quality picture or when you want to emphasize the quality of the image. When sending an image as an e-mail attachment, decrease the size of the file by selecting image dimensions. To emphasize picture quality, set the image quality to [FINE]. In other cases, use [NORMAL] to keep image files small and increase the number of recordable images.





[] Exposure Compensation

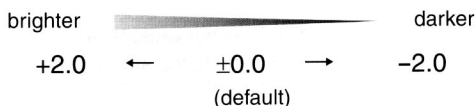

Exposure compensation is used when you want to adjust brightness. Compensation up to 2.0EV is possible in steps of 0.3EV in both the “+” and “-” directions.



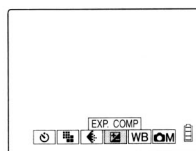

Operation — setting to [+0.3]

- 1 Turn on the power and set the mode select dial to “” or “”.
- 2 Press the MENU button to display the menu icons.

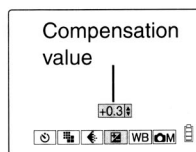

- 3 Press Left or Right on the directional keypad to select [] [EXP.COMP], then press the  button.



- 4 Press Up or Down on the directional keypad to select [+0.3], then press the  button.

- 5 When [+0.3] appears, the setting is completed.
Press the MENU button to turn off the menu display for shooting.

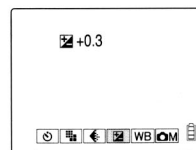

- The compensation value that has been set remains unchanged even after a picture is taken. (For example, once +0.3 is set, the value +0.3 is used for all images shot thereafter until you change the setting.)
- The compensation value will be returned to the default setting (±0.0) when the power is turned off. If you want to preserve the setting, set [MODE LOCK] to [ON]. (page 86)

Guidelines for using exposure compensation

Use this mode when suitable exposure cannot be obtained due to extreme differences in the brightness of the subject versus the background or when you wish to intentionally under- or over-expose an image.





* As an example of extreme differences in the brightness of the subject versus background, a scene on the stage with lighting coming from the spot light or a portrait in the location covered with snow.



[WB] White Balance Setting

The color of a subject varies depending on the light source. The color white is particularly affected by the light source. The adjustment used to make white look white is called “white balance.”

Types of White Balance

AUTO	Auto (default)	This sets the white balance automatically according to the surrounding conditions.
	Bright sun	
	Incandescent light bulbs (tungsten)	Since the light source is specified, you can take a picture without being influenced by the color of the subject.
	Cloudy weather	
	Fluorescent lights	
	Preset	The white balance selected in the [SET DETAILS] menu is used. The setting must be made before shooting images. (page 59)

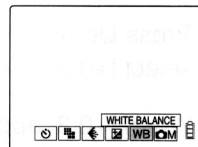

Operation — setting to

- 1 Turn on the power and set the mode select dial to “📷” or “🎥”.
- 2 Press the MENU button to display the menu icons.

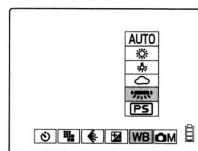

- 3 Press Left or Right on the directional keypad to select WB [WHITE BALANCE], then press the  button.



- 4 Press Up or Down on the directional keypad to select , then press the  button.

- 5 When  appears, the setting is completed. Press the MENU button to turn off the menu display for shooting.

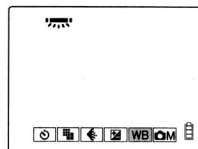

- This mode will be returned to the default setting [AUTO]. If you want to preserve the setting, set [MODE LOCK] to [ON]. (page 86)



[🎤] Shooting Movies with or without Audio

You can select whether or not to record audio when shooting movie. If [ON] is selected to record audio along with a movie, zooming during shooting is not possible. If [OFF] is selected for not recording audio, zooming is possible.



[ON] (default) Audio can be recorded with a movie, but zooming during shooting is impossible.



[OFF] No audio is recorded with a movie, but zooming during shooting is possible.

Operation — setting to [OFF]

- 1 Turn on the power and set the mode select dial to “🎥”.
- 2 Press the MENU button to display the menu icons.

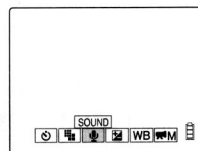

- 3 Press Left or Right on the directional keypad to select 🎤 [SOUND], then press the button.

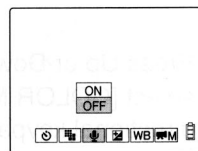

- 4 Press Up or Down on the directional keypad to select [OFF], then press the button.

- 5 When [🎤] appears, the setting is completed.
Press the MENU button to turn off the menu display for shooting.

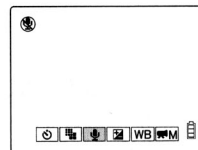

- The specifications of this camera do not allow zooming while shooting movies with audio to avoid recording the zooming sound. To use zooming, either zoom before shooting to achieve the desired composition, or set not to record audio and then shoot.





[M]/[M] [COLOR MODE] — Selecting Color, B/W or Sepia Mode



This function sets colors similar to photographs shot using sepia or monochrome film.

No icon	COLOR (default)
[B/W]	B/W
[SEPIA]	SEPIA

Operation — setting to [SEPIA]

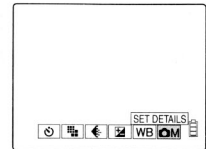
- 1 Turn on the power and set the mode select dial to “” or “”.
- 2 Press the MENU button to display the menu icons.



- 3 Press Left or Right on the directional keypad to select [M] or [M], then press the  button.

- 4 Press Up or Down on the directional keypad to select [COLOR MODE], then press Right on the directional keypad.

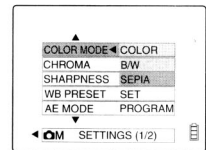

- 5 Press Up or Down on the directional keypad to select [SEPIA], then press the  button.

- 6 Press the MENU button.

When the menu display is turned off, the setting is completed. [SEPIA] will appear on the LCD monitor.

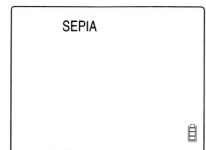



- This mode will be returned to the default setting when the power is turned off.

[📷][CHROMA] — Changing the Contrast

The [CHROMA] setting allows to shoot images with enhanced or reduced contrast.

[📷]+1	+	High contrast
No icon	STANDARD (default)	▼
[📷]-1	-	Low contrast

Operation — setting to [+]

- 1 Turn on the power and set the mode select dial to "📷".
- 2 Press the MENU button to display the menu icons.
- 3 Press Left or Right on the directional keypad to select 📷 [SET DETAILS], then press the  button.
- 4 Press Up or Down on the directional keypad to select [CHROMA], then press Right on the directional keypad.
- 5 Press Up or Down on the directional keypad to select [+], then press the  button.
- 6 Press the MENU button. When the menu display is turned off, the setting is completed.
[📷]+1 will appear on the LCD monitor.

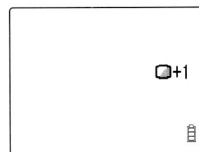
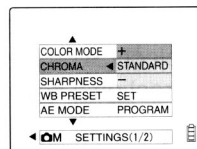

- Since the setting for this mode is saved even if the power is turned off, it is necessary to reset the setting depending on the scene and subject to be shot.



[📷][SHARPNESS] — Sharpening the Outline

Use this mode to enhance or soften the outline of the subject.

[📷]+3	+3	Intensifies outline enhancement.
[📷]+2	+2	
[📷]+1	+1	
No icon	STANDARD (default)	
[📷]-1	-1	Suppresses outline enhancement.



Operation — setting to [+2]

- 1 Turn on the power and set the mode select dial to “📷”.
- 2 Press the MENU button to display the menu icons.
- 3 Press Left or Right on the directional keypad to select 📷 [SET DETAILS], then press the ↵ button.
- 4 Press Up or Down on the directional keypad to select [SHARPNESS], then press Right on the directional keypad.
- 5 Press Up or Down on the directional keypad to select [+2], then press the ↵ button.
- 6 Press the MENU button. When the menu display is turned off, the setting is completed.
[📷+2] will appear on the LCD monitor.

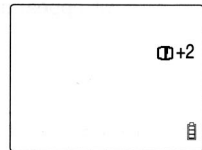
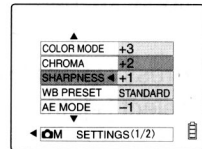



- Since the setting for this mode is saved even if the power is turned off, it is necessary to reset the setting depending on the scene and subject to be shot.

[📷M]/[🎥M][WB PRESET] — Setting White Balance Manually

Use this mode if there are multiple light sources or you want to set white absolutely.

Operation

Prepare an object such as a piece of white paper for setting the standard for "white".

- 1 Turn on the power and set the mode select dial to "📷" or "🎥".
- 2 Press the MENU button to display the menu icons.
- 3 Press Left or Right on the directional keypad to select [📷M] or [🎥M], then press the  button.
- 4 Press Up or Down on the directional keypad to select [WB PRESET], then press Right on the directional keypad.
- 5 Locate the camera above the white subject you have prepared until the image fills the screen and select [SET] then press the  button.

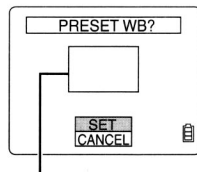
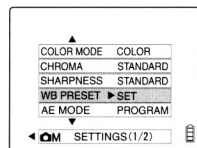

Make sure the subject fills the entire screen.

White subject such as a piece of paper

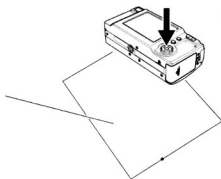

- 6 Press the MENU button. When the menu display is turned off, the setting is completed. [PS] will appear on the LCD monitor.

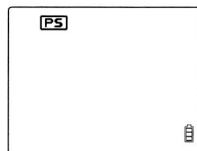

- Since the setting for this mode is saved even if the power is turned off, it is necessary to reset the setting depending on the scene and subject to be shot.
- Set the mode respectively in Camera 📷 and Movie 🎥 mode.







[AE MODE] — Selecting the Exposure Mode

This function can be set to [PROGRAM] so that the camera automatically determines the aperture value and the shutter speed or to [F2.8] or [F7.5] so that the aperture value is fixed and the shutter speed is left up to the camera. The larger the aperture value, the wider the area (front to back) that is clearly in focus around the subject.

No icon	PROGRAM (default)	The camera determines the shutter speed and aperture value according to the subject.
[F2.8]	F2.8	The area clearly in focus is lengthwise narrower, making the subject stand out.
[F7.5]	F7.5	The area clearly in focus is lengthwise wider and the subject, background and foreground are clearly photographed. However, the flash light reaches shorter in the flash modes.

Operation — setting to [F7.5]

- 1 Turn on the power and set the mode select dial to “”.
- 2 Press the MENU button to display the menu icons.
- 3 Press Left or Right on the directional keypad to select  [SET DETAILS], then press the  button.
- 4 Press Up or Down on the directional keypad to select [AE MODE], then press Right on the directional keypad.
- 5 Press Up or Down on the directional keypad to select [F7.5], then press the  button.
- 6 Press the MENU button. When the menu display is turned off, the setting is completed.
[F7.5] will appear on the LCD monitor.

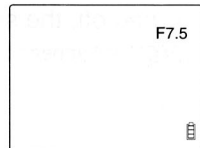
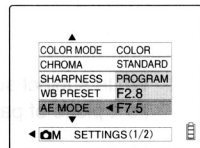



- Since the setting for this mode is saved even if the power is turned off, it is necessary to reset the setting depending on the scene and subject to be shot.

/[][FOCUSING] — Selecting the Focus Mode







This function allows you to select the focus mode.

You can select automatic focus modes [WIDE AF*] or [SPOT AF*] and manual focus mode [MF].

* AF: Auto focus

	WIDE AF	Provides a wide focus frame. The area clearly in focus becomes wider so that this mode is good to shoot two people standing side by side.
	SPOT AF (default)	Shots are taken with a regular focus frame.
	MF	Allows you to focus manually by determining the focus distance. Focus distance: 0.6 m to ∞

Operation — setting to [MF]

- 1 Turn on the power and set the mode select dial to “” or “”.
- 2 Press the MENU button to display the menu icons.
- 3 Press Left or Right on the directional keypad to select [M] or [M], then press the  button.
- 4 Press Up or Down on the directional keypad to select [FOCUSING], then press Right on the directional keypad.
- 5 Press Up or Down on the directional keypad to select [MF], then press the  button.
- 6 Press the MENU button. When the menu display is turned off, the setting is completed.
The focus gauge will appear on the LCD monitor.

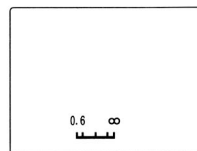
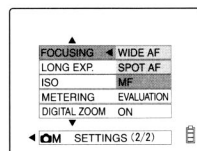

Deciding the Focus Distance

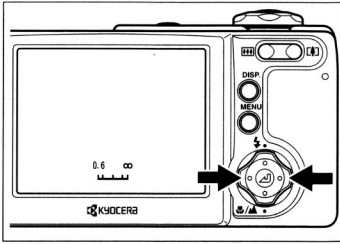

Press Left or Right on the directional keypad to select the desired focus distance.

- The focus cannot be set with the viewfinder when [MF] is selected. Use the LCD monitor.

General guidelines for the focus distance

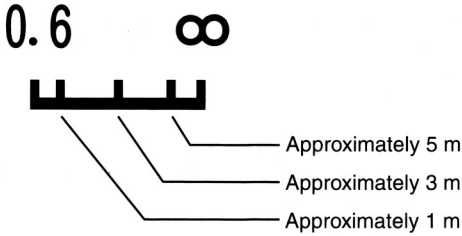

- Since the setting for this mode is saved even if the power is turned off, it is necessary to reset the setting depending on the scene and subject to be shot.





[LONG EXP.] — Slowing the Shutter Speed

Slow the shutter speed when taking a shot of a starry night sky or small light (such as a candle) in the middle of darkness. The shutter speed is the length of time the shutter is open. The longer the shutter is open, the longer the time that the subject is exposed.

[LT8S]	8SEC	Shutter speeds of 2 seconds, 4 seconds and 8 seconds can be set.
[LT4S]	4SEC	
[LT2S]	2SEC	
No icon	OFF (default)	Normal shots (1 to 1/2000 second) can be taken.

- Since the time to be set differs depending on the subject, check the shutter speed taking trial shots.

Operation — setting to [LT4S]

- 1 Turn on the power and set the mode select dial to “”.
- 2 Press the MENU button to display the menu icons.
- 3 Press Left or Right on the directional keypad to select  [SET DETAILS], then press the  button.
- 4 Press Up or Down on the directional keypad to select [LONG EXP.], then press Right on the directional keypad.
- 5 Press Up or Down on the directional keypad to select [4SEC], then press the  button.

Although the flash mode is set to , you can select fill-flash with red-eye reduction mode (page 53) by pressing UP on the directional keypad.

- 6 Press the MENU button. When the menu display is turned off, the setting is completed. [LT4S] will appear on the LCD monitor.

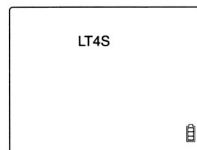
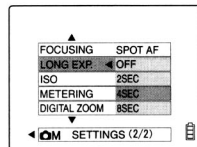

- The image may include noise when a long shutter speed is used.
- When the power is turned off, the mode will be returned to the default setting [OFF] and the normal shooting mode will be restored.
- Use a tripod to avoid camera shake.
- [LT4S] (4 SEC) or [LT8S] (8 SEC) might not be selected in this mode according to your selection of ISO sensitivity (page 64). For the details, see page 102.





[M][ISO] — Changing ISO Sensitivity to Shoot Subjects

[ISO] refers to sensitivity to light equivalent to the ISO sensitivity of film.

The settings include [AUTO], [80], [160] and [320]. Sensitivity to light increases to allow shots in dark places or using a high-speed shutter. In addition, the distance that the flash can reach will be increased.

[ISO320]	320	
[ISO160]	160	Sets a fixed ISO sensitivity.
[ISO80]	80	
No icon	AUTO (default)	ISO sensitivity matching the surrounding conditions is set by the camera.

Operation — setting to [ISO160]

- 1 Turn on the power and set the mode select dial to “”.
- 2 Press the MENU button to display the menu icons.
- 3 Press Left or Right on the directional keypad to select M [SET DETAILS], then press the  button.
- 4 Press Up or Down on the directional keypad to select [ISO], then press Right on the directional keypad.
- 5 Press Up or Down on the directional keypad to select [160], then press the  button.
- 6 Press the MENU button. When the menu display is turned off, the setting is completed. [ISO160] will appear on the LCD monitor.

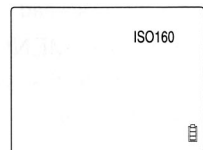
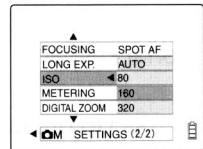





- Noise may appear on the image by increasing the ISO sensitivity to [320].
- Since the setting for this mode is saved even if the power is turned off, it is necessary to reset the setting depending on the scene and subject to be shot.
- [ISO160] or [ISO320] might not be selected in this mode according to your selection of [LONG EXP.] (page 63). For the details, see page 102.

[M][METERING] — Selecting the Area to be Exposed

In this mode, it is possible to select the area to be exposed. Three settings are available: [EVALUATION], [CENTER] and [SPOT AREA]. Use these settings depending on the subject.

No icon	EVALUATION (default)	With this method, the entire screen is divided into 224 sections and the amount of light is measured for each to determine the best exposure value for the subject.
<input type="checkbox"/>	CENTER	With this method, weight is given to the amount of light in the central area of the screen (larger than SPOT AREA).
<input type="checkbox"/>	SPOT AREA	With this method, the amount of light at the center of the screen is measured.

Operation — setting to [SPOT AREA]

- 1 Turn on the power and set the mode select dial to “”.
- 2 Press the MENU button to display the menu icons.
- 3 Press Left or Right on the directional keypad to select [M] [SET DETAILS], then press the  button.
- 4 Press Up or Down on the directional keypad to select [METERING], then press Right on the directional keypad.
- 5 Press Up or Down on the directional keypad to select [SPOT AREA], then press the  button.
- 6 Press the MENU button. When the menu display is turned off, the setting is completed.
[] will appear on the LCD monitor.

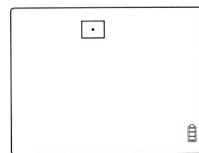
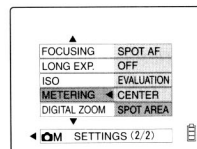

- Since the setting for this mode is saved even if the power is turned off, it is necessary to reset the setting depending on the scene and subject to be shot.



[M][DIGITAL ZOOM] — Using Digital Zoom or Not





When composing your picture, first press the “” button until the optical zoom is maximized, release and press it again to begin digital zooming. (page 41)

Select [OFF] for not using digital zoom.

ON (Default)	Digital zoom can be used.
OFF	Digital zoom cannot be used.

- There is no icon display for either setting.

Operation — setting to [OFF]

- 1 Turn on the power and set the mode select dial to “”.
- 2 Press the MENU button to display the menu icons.
- 3 Press Left or Right on the directional keypad to select M [SET DETAILS], then press the  button.
- 4 Press Up or Down on the directional keypad to select [DIGITAL ZOOM], then press Right on the directional keypad.
- 5 Press Up or Down on the directional keypad to select [OFF], then press the  button.
- 6 Press the MENU button. When the menu display is turned off, the setting is completed.

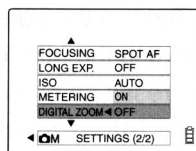

- Since the setting for this mode is saved even if the power is turned off, resetting will be necessary depending on the scene and subject to be shot.



Using Playback “▶” Mode Functions

Playback Mode is used to check images that have been shot. Playback Mode also includes functions for adding audio to images and rotating images 90°.

[MULTI] Multiple Image Playback

With multiple image display, it is possible to display six thumbnail images on the LCD monitor.

Viewing Pictures on the Multiple Image Display

- 1 Turn on the power and set the mode select dial to “▶”.
- 2 Press the MENU button to display the menu icons.
- 3 Press Left or Right on the directional keypad to select  [MULTI], then press the  button.
The multiple image playback screen appears.

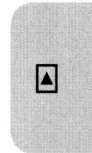
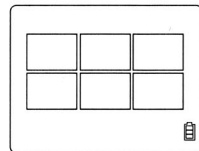
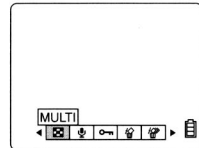

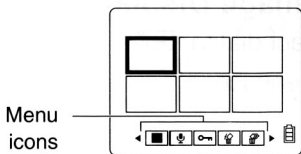
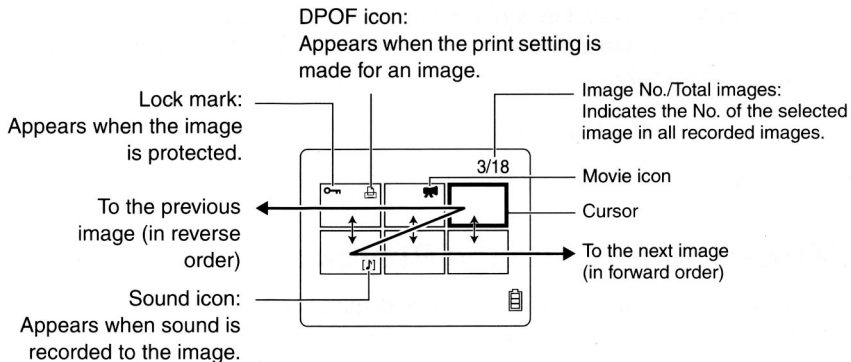

Multiple Image Display and Operations



- Press Left on the directional keypad to move the cursor to the previous image and Right on the directional keypad to move the cursor to the next image.
- Press Up on the directional keypad to move the cursor to the image above and Down on the directional keypad to move the cursor to the image below.
- Press the MENU button to display the menu icons.

Erasing an Image on the Multiple Image Display.

- 1 Press the MENU button to display the menu icons.
- 2 Press Left or Right on the directional keypad to select  [ERASE], then press the  button.

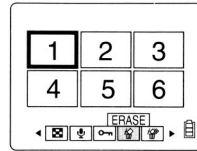

- 3 Use the directional keypad to move the cursor to the image you wish to erase.
- 4 Press Up on the directional keypad to select [EXECUTE], then press the  button.

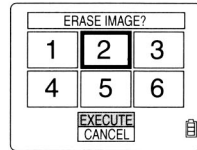

The image will be erased.

- To erase other images, repeat steps 3 and 4.

- 5 Press the MENU button to finish the erasure operation.
The multiple image display will appear again.

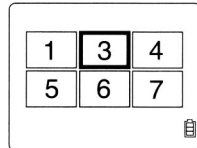

Returning to the normal playback (single image display)

- 1 Use the directional keypad to move the cursor to the image you wish to display for the normal playback.
- 2 Press the  button to return to the normal display.

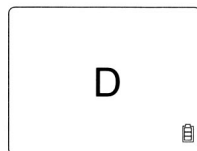
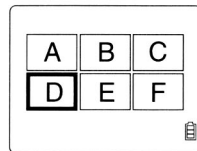

[RECORDING] Adding a Voice Message to an Image

Audio can be added to and erased from still images that have been shot.

- You cannot use this operation while the SD memory card is write-protected. For write protect, see page 15.

Recording Audio

1 Turn on the power and set the mode select dial to "▶".

2 Press the MENU button to display the menu icons.

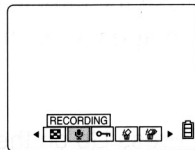

3 Press Left or Right on the directional keypad to select [RECORDING], then press the button.

4 Press Left or Right on the directional keypad to select the image.

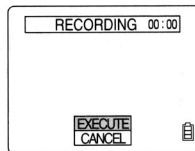

5 Press Up on the directional keypad to select [EXECUTE], then press the button. The audio recording starts.

6 Speak toward the microphone on the camera.

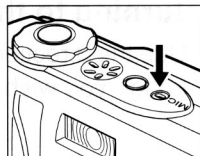

Counts the elapsed seconds during recording.

- The maximum recording time is 30 seconds.

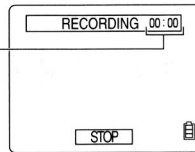

7 Press the button to stop recording before 30 seconds have elapsed.

8 Press MENU button to finish audio recording.

- After recording, the number of recordable images might be reduced. See (page 52).

Erasing the Audio

You can erase the audio recorded using the [RECORDING] function. Be careful when erasing audio as it cannot be restored after it is erased.

- The audio in movie cannot be erased.

Before proceeding, perform steps 1 to 3 of "Recording Audio".

4 Press Left or Right on the directional keypad to select the image from which you wish to erase the audio.

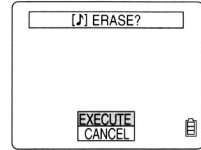

5 Press Up on the directional keypad to select [EXECUTE], then press the **▶** button.

The audio is erased and [RECORDING] appears on the display.

6 Press the MENU button to finish the operation.

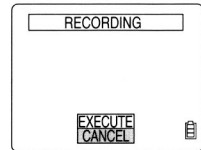

Playing back the audio

The image with audio is displayed as shown below.

The display before the audio playback

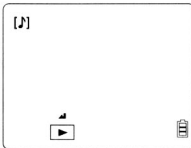

- Press the **▶** button to start playback.

The display during audio playback

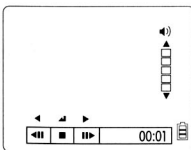

- Press the **▶** button to stop playback.
- Press Up or Down on the directional keypad to adjust the volume.
- Press and hold Right on the directional keypad to enter the 2x (fast-forward) playback, Releasing the keypad returns to normal playback.
- Press and hold Left on the directional keypad to enter the 1/2x (slow) playback, Releasing the keypad returns to normal playback.

[PROTECT] Protecting Images from being Erased

Important images can be protected against accidental erasure.

- You cannot use this operation while the SD memory card is write-protected. For write protect, see page 15.

To protect images

- 1 Turn on the power and set the mode select dial to “▶”.
- 2 Press the MENU button to display the menu icons.

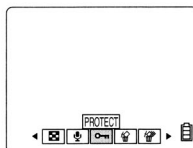

- 3 Press Left or Right on the directional keypad to select [PROTECT], then press the button.

- 4 Press Left or Right on the directional keypad to select the image you wish to protect.

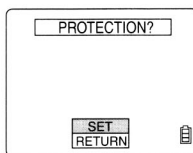

- 5 Select [SET] and press the button to protect the image.
 - To protect other images, repeat steps 4 and 5.

- 6 Press the MENU button to finish the operation.

- The protected images will not be erased even if [ERASE ALL] is executed, but they will be erased when the memory card is formatted.



[ERASE] Erasing Individual Images

- Use caution when erasing an image. You cannot restore the erased image.
- The protected images cannot be erased. (page 72)
- You cannot use this operation while the SD memory card is write-protected. For write protect, see page 15.

To Erase an Image

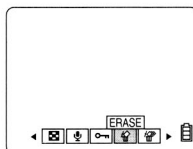
- 1 Turn on the power and set the mode select dial to “▶”.
- 2 Press the MENU button to display the menu icons.



- 3 Use the directional keypad to select  [ERASE], then press the  button.
- 4 Press Left or Right on the directional keypad to select the image you wish to erase.
- 5 Press Up on the directional keypad to select [EXECUTE], then press the  button to erase the image.
 - To erase other images, repeat steps 4 and 5.
 - If an image with audio (page 72) is erased, audio will also be erased.
- 6 Press the MENU button to finish the operation.

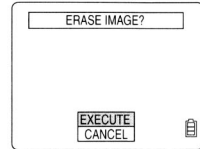



[ERASE ALL] Erasing All Images

You can erase all images recorded in the memory card.

- Use caution when erasing an image. You cannot restore the erased image.
- The protected images cannot be erased. (page 72)
- You cannot use this operation while the SD memory card is write-protected. For write protect, see page 15.

To Erase All Images

- 1 Turn on the power and set the mode select dial to “▶”.
- 2 Press the MENU button to display the menu icons.
- 3 Press Left or Right on the directional keypad to select  [ERASE ALL], then press the  button.

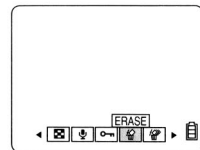

- 4 Press Up on the directional keypad to select [EXECUTE], then press the  button to erase all images.
 - If an image is displayed, the image might have been protected.
 - If an image with audio (page 70) is erased, audio will be also erased.

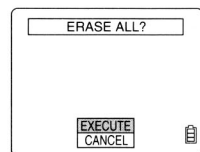

- 5 Press the MENU button to finish the operation.

[RESIZE] Resizing and Trimming Images

You can change (resize) image dimensions and clip (trim) images. Since an image that has been resized or trimmed is saved as a new image, it is possible to keep the original image.

- Resized images are recorded in the directory as shown on the right.

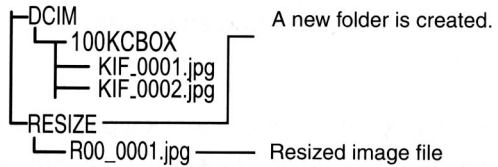

- You cannot use this operation while the SD memory card is write-protected. For write protect, see page 15.
- Files can be created under the name from [R00_0001.jpg] to [R00_9999.jpg] in the memory card. You cannot resize more than 9999 images in this card.

To Resize an Image

1 Turn on the power and set the mode select dial to "▶".

2 Press the MENU button to display the menu icons.

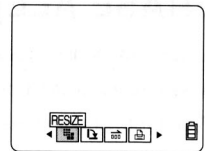

3 Press Left or Right on the directional keypad to select [RESIZE], then press the **▶** button.

4 Select [EXECUTE RESIZING], then press the **▶** button.

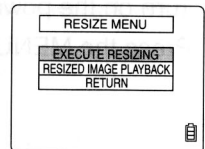

5 Press Left or Right on the directional keypad to select the image, press Up on the directional keypad to select [OK], then press the **▶** button.



6 Set the area to be resized.

When changing image dimensions only

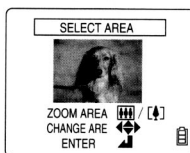

Press the **▶** button.

When enlarging the area

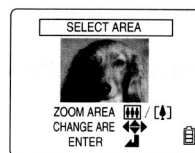

Press the **◀** button to enlarge the image (2x or 4x magnification). Use the directional keypad to set the area, then press the **▶** button.

- 7 Press Up or Down on the directional keypad to select the image size, then press the **⏮** button.

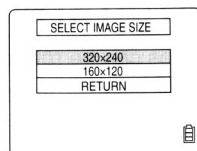

- 8 The name of the resized image will be displayed. Press the **⏮** button after checking the name.



- 9 Press the MENU button to finish the operation.

Confirming and Deleting the Resized Image

Resized images cannot be displayed in normal playback mode. To display the resized images, follow the procedure below.

Before proceeding, perform steps 1 to 3 of "To Resize an Image".

- 4 Press Down on the directional keypad to select [RESIZED IMAGE PLAYBACK], then press the **⏮** button.

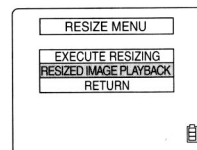

The resized image will be displayed.

Press Left or Right on the directional keypad to view the images in forward or reverse order.

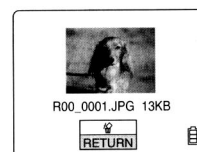

- 5 To erase the resized image, press Up or Down on the directional keypad to select [🗑️], then press the **⏮** button.

- Be careful pressing the **⏮** button once erases the resized image.

- 6 Press the MENU button to finish the operation.

- It is impossible to protect resized images.

[ROTATE] Rotating Images

Images can be rotated 90° to either right or left.

- You cannot use this operation while the SD memory card is write-protected. For write protect, see page 15.

To Rotate the Image to [90°↶]

- 1 Turn on the power and set the mode select dial to “▶”.
- 2 Press the MENU button to display the menu icons.

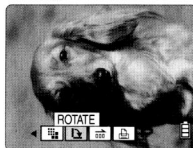

- 3 Press Left or Right on the directional keypad to select [↶] [ROTATE], then press the [ENTER] button.

- 4 Press Left or Right on the directional keypad to select the image you wish rotate.

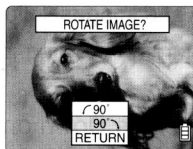

- 5 Press Up or Down on the directional keypad to select [90°↶], then press the [ENTER] button.

[↶90°] Rotate 90° to the left.

[90°↶] Rotate 90° to the right.

[RETURN] Returns to the menu icon display.

The rotated image will be displayed.

- To rotate other images, repeat steps 4 and 5.

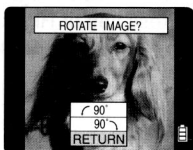

- 6 Press the MENU button to finish the operation.

[AUTO PLAY] Automatic Playback



This function plays back images automatically at set intervals.

Operation

1 Turn on the power and set the mode select dial to "▶".

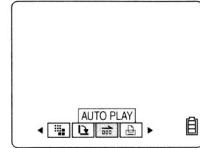
2 Press the MENU button to display the menu icons.



3 Press Left or Right on the directional keypad to select  [AUTO PLAY], then press the  button.

4 Set the interval.

① Press Up or Down on the directional keypad to select [INTERVAL], then press Right on the directional keypad.

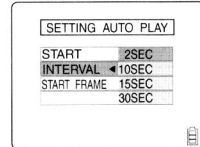



② Press Up or Down on the directional keypad to select a playback interval, then press the  button.

5 Set the first frame.

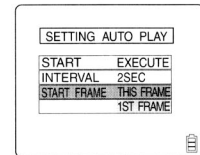
① Press Up or Down on the directional keypad to select [START FRAME], then press Right on the directional keypad.



② Press Up or Down on the directional keypad to select [THIS FRAME] or [1ST FRAME], then press the  button.

6 Press Up or Down on the directional keypad to select [EXECUTE], then press the  button to start automatic playback.

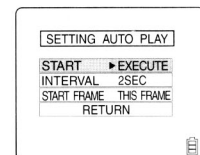

7 Press the  button to stop automatic playback.

• Pressing MENU button also stops automatic playback.

[SETTING PRINT] Digital Print Order Format (DPOF) Setting

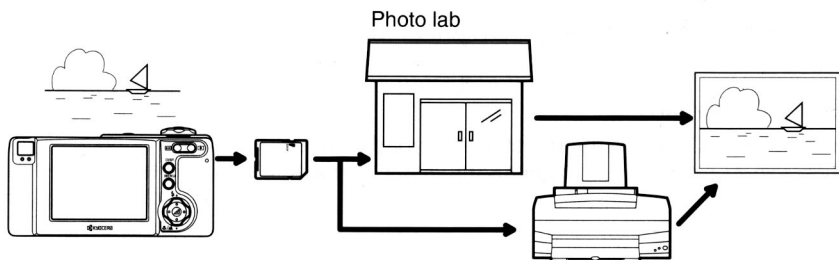

Digital Print Order Format (DPOF) is a standard used when printing digital photographs on a home printer or by a commercial printing service. The function is a simple way of specifying the number of copies to be printed, the need for date imprinting, and so on. Before using this function, confirm that your home printer or commercial photo printing service supports DPOF. When printing on a home printer, be sure to read and follow the operating instructions for it.

- You cannot use this operation while the SD memory card is write-protected. For write protect, see page 15.



Operation

- 1 Turn on the power and set the mode select dial to "▶".
- 2 Press the MENU button to display the menu icons.

- 3 Press Left or Right on the directional keypad to select  [PRINT], then press the  button.

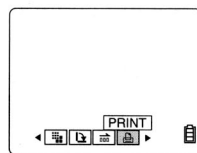

- 4 Press Up or Down on the directional keypad to select [PRINT], then press Right on the directional keypad.

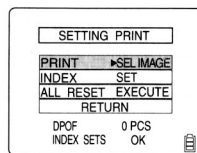

- 5 Press Left or Right on the directional keypad to select the image to be printed, then select [OK] and press the  button.

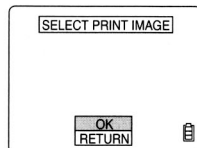

6 Set the number of prints.

- Press Up or Down on the directional keypad to select [PRINT QTY], then press Right on the directional keypad.

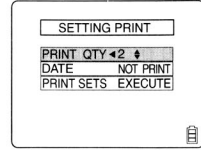

- Press Up or Down on the directional keypad to set the number of prints, then press the **▶** button.

7 Set to print the date or not.

- Press Up or Down on the directional keypad to select [DATE], then press Right on the directional keypad.

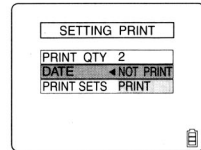

- Press Up or Down on the directional keypad to select [PRINT] or [NOT PRINT], then press the **▶** button.

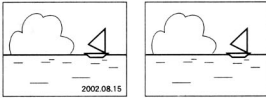

- Use caution when selecting "PRINT". When [PRINT] is set to the [INSERT DATE] (page 83) in the setup mode and [PRINT] is reselect in this mode, the date printing is doubled.

- Press Up or Down on the directional keypad to select [PRINT SET], then press Right on the directional keypad.

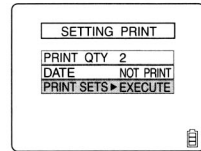

- Press Up or Down on the directional keypad to select [EXECUTE], then press the **▶** button to complete the DPOF setting.

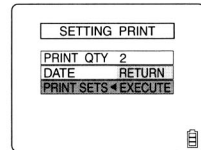

- If you select [RETURN], changes will not be applied to the setting and the display returns to the [SETTING PRINT] screen.

The display returns to the [SETTING PRINT] screen.

- To set the DPOF setting for other images, repeat steps 4 to 9.

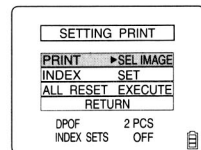

Setting an Index Print

You can print an index of images recorded in the memory card.

Before proceeding, perform steps 1 to 3 of "Setting the DPOF".

- Press Up or Down on the directional keypad to select [INDEX], then press Right on the directional keypad.

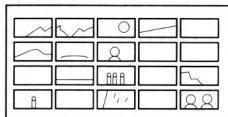

- Press Up or Down on the directional keypad to select [SETUP INDEX PRINT], then press the **▶** button to complete the setting.

[SETUP INDEX PRINT]

Images are printed in an index.

[ERASE INDEX SETTING]

Cancel the index print.

[RETURN]

The display returns to the [SETTING PRINT] screen.

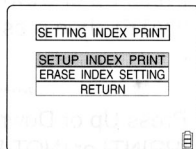
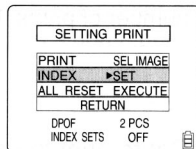

Resetting all print settings

Before proceeding, perform steps 1 to 3 of "Setting the DPOF".

- Press Up or Down on the directional keypad to select [ALL RESET], then press Right on the directional keypad.

- Press Up or Down on the directional keypad to select [EXECUTE], then press the **▶** button to release all print settings.

The display returns to the [SETTING PRINT] screen.

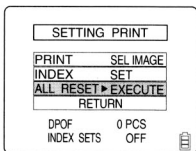
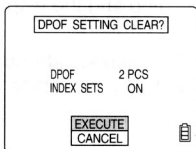
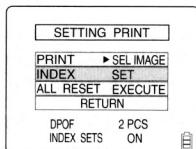

A Useful Way to Erase Images Using the Protect and All Erase Functions

If, for example, you have recorded 100 images and you only want to keep 5 or 6 of them, erasing the unwanted images one at a time is difficult work. If you have recorded a lot of images and only wish to keep a few, use [PROTECT] and [ERASE ALL] to make the operation easier.

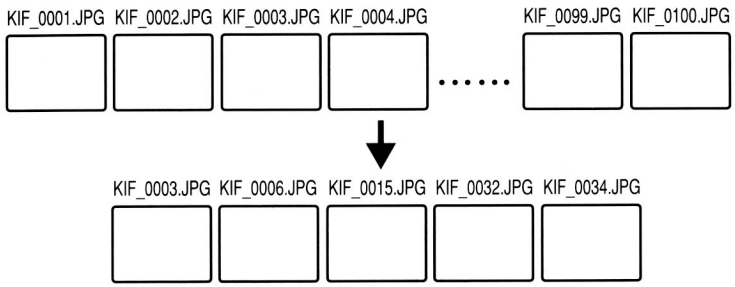

First, protect the images that should be kept. (Use the multiple image display.)

- 1 Display the menu icons and select [PROTECT].
- 2 Press Left or Right on the directional keypad to display the image desired that should be kept, then press the button.
Repeat this procedure to select the images that should be kept.

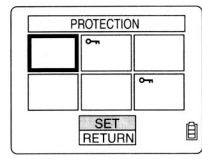

Then, erase all images.

- 1 Display the menu icons to select [ERASE ALL] then press the button.
[ERASE ALL?] appears on the screen.
- 2 Select [EXECUTE], then press the button to erase all images.
- 3 Protected images will not be erased but kept in the memory card.

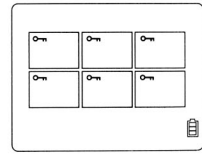
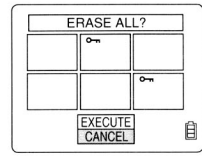

Using Setup “SET UP” Mode Functions

Functions such as setting the date and formatting the memory card are only performed infrequently, but they are convenient and important functions. Such functions are included in “SET UP” mode.

[BRIGHT CNTRL] Setting Brightness of the LCD Monitor

This function adjusts brightness of the LCD monitor.

Operation

- 1 Turn on the power and set the mode select dial to “SET UP”.
- 2 Press Up or Down on the directional keypad to select [BRIGHT CNTRL], then press Right on the directional keypad.
- 3 Press Up or Down on the directional keypad to select the brightness, press the  button to complete the setting.

Select + to make the LCD monitor brighter and – to make it darker.

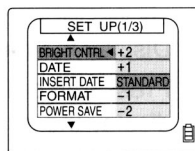

[INSERT DATE] Setting to Write the Date in the Image

Use this function if you want the date to be written in the image. Once the function is set to [WITH DATE], the date is written in images when shooting.

[WITH DATE] The date is written in images when shooting.

[NO DATE]
(default) The date is not written.

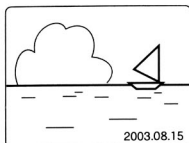

- The date is written on the right bottom corner of the image.

- Once the date is written on an image, you cannot erase the date.

Operation — setting to [WITH DATE]

- 1 Turn on the power and set the mode select dial to "SET UP".
- 2 Press Up or Down on the directional keypad to select [INSERT DATE], then press Right on the directional keypad.
- 3 Press Up on the directional keypad to select [WITH DATE], then press the  button to complete the setting.

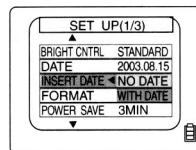

- When the function is set to [WITH DATE], the date is always displayed on the LCD monitor when shooting.

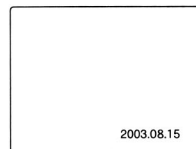

[FORMAT] Formatting the Memory Card

Use this function before using a new memory card or when erasing all data including images.

Operation to format a memory card.

1 Turn on the power and set the mode select dial to "SET UP".

2 Press Up or Down on the directional keypad to select [FORMAT], then press Right on the directional keypad.

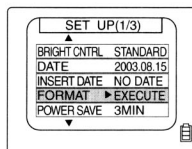

3 Press Up on the directional keypad to select [EXECUTE], then press the  button to begin formatting.

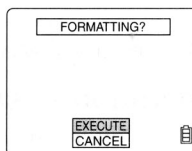

4 When formatting is completed, the display returns to the [SET UP(1/3)] screen.

- Note that protected images will also be erased.

[POWER SAVE] Saving Power by Turning Power Off Automatically

This camera is equipped with an Auto Power-off function that automatically turns the power off after several minutes if the camera is left on without any operation being performed. This function helps to reduce power consumption if you forget to turn off the camera. You can select the length of time before power is turned off.

[NO PWR OFF]	The power will not be turned off automatically. Do not forget to turn off the camera.
[15SEC.]*	The power will be turned off automatically if the camera is left inactive for more than 15 seconds, 1 minute, 3 minutes, or 6 minutes.
[1MIN.]	
[3MIN.]	
[6MIN.]	

*In the Playback mode or the Set Up mode, the power is automatically turned off after 1 minute.

Operation — setting to [1MIN.]

- 1 Turn on the power and set the mode select dial to "SET UP".
- 2 Press Up or Down on the directional keypad to select [POWER SAVE], then press Right on the directional keypad.
- 3 Press Up on the directional keypad to select the length of time before power is turned off, then press the  button to complete the setting.

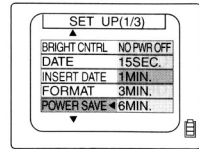

<Note regarding camera used in the "📷/📹" mode:>

When using the camera in the "📷/📹" mode, the auto power-off setting will cause the camera to respond as follows:

1 When [POWER SAVE] is set to one of [15SEC], [1MIN], [3MIN] and [6MIN]:



With this setting, if the camera is left inactive for more than the specified period of time, it will automatically enter the sleep mode for two minutes, after which the power will turn off. During the two-minute power-save sleep period, the camera can be quickly restored to its original shooting mode by depressing the shutter button halfway, or by pressing one of the other function buttons.

After the two minutes have expired, the camera power will automatically turn off.

2 When [POWER SAVE] is set to [NO PWR OFF]:

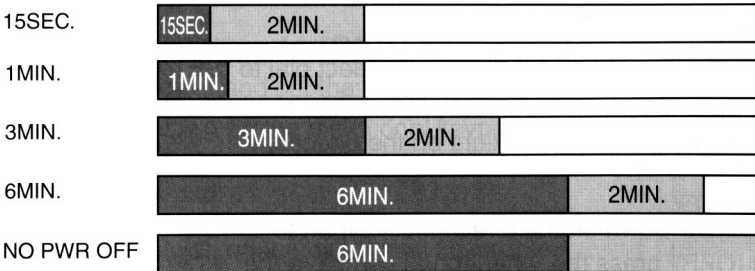
With this setting, when the camera is left inactive for more than six minutes, it automatically enters the sleep mode. (In this case, the camera remains in the sleep mode indefinitely, without the power turning off.) To restore the camera to its normal shooting mode, depress the shutter button halfway, or press one of the other function buttons.



-  Power on and camera in ready but inactive state.
-  Sleep mode; camera operation stops with lens in extended position, but function can be restored by pressing the shutter button halfway, or by pressing other function buttons.
-  Power OFF.

[MODE LOCK] Preserving the Mode Settings

This function preserves the camera mode functions set in the "CAM", "M" or "SET UP" mode when the power is turned OFF. (page 98)

- [ON] Mode settings are preserved even if the power is turned off.
- [OFF] Mode settings will be returned to their default values when the power is turned off.
- (default)

Operation — setting to [ON]

- 1 Turn on the power and set the mode select dial to "SET UP".
- 2 Press Up or Down on the directional keypad to select [MODE LOCK], then press Right on the directional keypad.
- 3 Press Up on the directional keypad to select [ON], then press the  button to complete the setting.

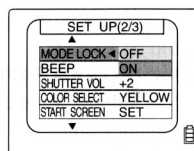

[BEEP] Setting the Volume of the Electronic Beeps

- [+3] Turns the volume up.
- [+2] Middle level (default)
- [+1] Turns the volume down.
- [OFF] Turns the beeping sound off. (The starting sound is also off.)

Operation — setting to [OFF]

- 1 Turn on the power and set the mode select dial to "SET UP".
- 2 Press Up or Down on the directional keypad to select [BEEP], then press Right on the directional keypad.
- 3 Press Up or Down on the directional keypad to select [OFF], press the  button to complete the setting.

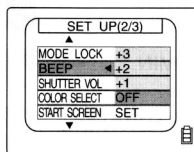

[SHUTTER VOL] Setting the Volume of the Shutter Sound

- [+3] Turns the volume up.
- [+2] Middle level (default)
- [+1] Turns the volume down.
- [OFF] Turns the shutter sound off.

Operation — setting to [+1]

- 1 Turn on the power and set the mode select dial to "SET UP".
- 2 Press Up or Down on the directional keypad to select [SHUTTER VOL], then press Right on the directional keypad.
- 3 Press Up or Down on the directional keypad to select [+1], then press the  button to complete the setting.

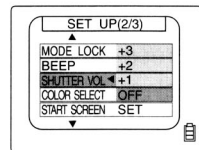

[COLOR SELECT] Setting the Color of Menu Display

- [YELLOW] (default)
- [RED]
- [PURPLE]
- [BLUE]

Operation — setting to [RED]

- 1 Turn on the power and set the mode select dial to "SET UP".
- 2 Press Up or Down on the directional keypad to select [COLOR SELECT], then press Right on the directional keypad.
- 3 Press Up or Down on the directional keypad to select [RED], then press the  button to complete the setting.

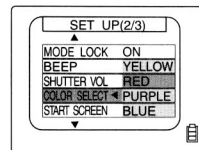

[START SCREEN] Selecting the Startup Screen

There are three types of startup screen.

- KYOCERA logo screen (default)
- Customized screen You can select an image recorded in the memory card as a startup screen.
- [OFF] Nothing appears on start screen.

Operation

- 1 Turn on the power and set the mode select dial to "SET UP".
- 2 Press Up or Down on the directional keypad to select [START SCREEN], then press Right on the directional keypad.
- 3 Press Left or Right on the directional keypad to select one of the screens, then press the **OK** button to complete the setting.

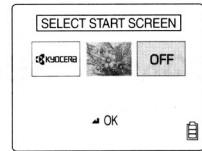
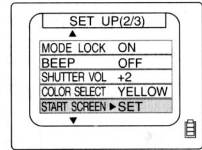

Operation — Setting an image as startup screen

- 1 Select the center image in step 3 of [Operation], then press Down on the directional keypad.
- 2 Press Left or Right on the directional keypad to select the image, then press the **OK** button.
- 3 Select [SET] and press the **OK** button.
- 4 Select the center image, then press the **OK** button to complete the setting.

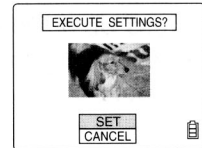
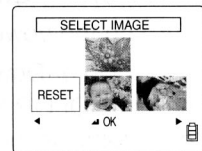

- As the image set for the startup screen is saved in the camera's memory, the startup screen will not change even if you replace the memory card or delete the image.

SET UP

[REC REVIEW] Reviewing the Image Just after Shooting

You can display the image for a few seconds immediately after shooting.

[OFF]	The image will not be displayed after shooting.
[2SEC] (default)	The image is displayed for 2 seconds after shooting.
[4SEC]	The image is displayed for 4 seconds after shooting.

Operation — setting to [OFF]

- 1 Turn on the power and set the mode select dial to "SET UP".
- 2 Press Up or Down on the directional keypad to select [REC REVIEW], then press Right on the directional keypad.
[REC REVIEW] menu screen appears.
- 3 Press Up or Down on the directional keypad to select [OFF], then press the  button to complete setting.

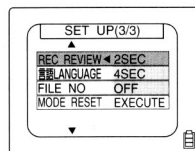

[LANGUAGE] Selecting the Display Language

[日本語]	Japanese
[ENGLISH]	English
[FRANÇAIS]	French
[DEUTSCH]	German
[ESPAÑOL]	Spanish
[中文]	Chinese(simplified)

Operation — setting to [FRANÇAIS]

- 1 Turn on the power and set the mode select dial to "SET UP".
- 2 Press Up or Down on the directional keypad to select [言語 LANGUAGE], then press Right on the directional keypad.
[REC REVIEW] menu screen appears.
- 3 Press Up or Down on the directional keypad to select [FRANÇAIS], then press the  button to complete the setting.

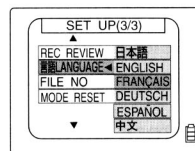

[FILE NO.] Resetting the File Number to 0001

The images are stored as files with consecutive numbers in the order images have been shot. These files are stored in the "100KCBOX" folder. If the consecutive file number is reset, a new folder is created on the memory card and a consecutive number starting from 0001 is attached to the new files placed in the new folder. Use this function for changing the folder for each separate photographic session.

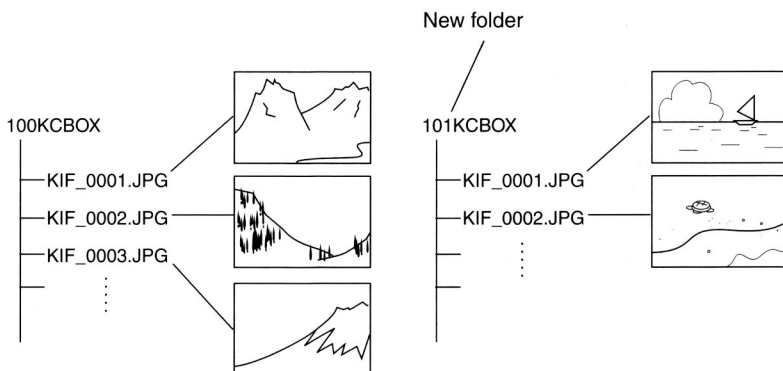

- When the folder name is [999KCBOX], the file number cannot be reset. (A new file cannot be created.)
- The folders that can be created are named from [100KCBOX] to [999KCBOX]. To reset the folder number to [100KCBOX], reset the File Number without inserting the memory card. After that, insert a formatted memory card or a memory card without data.

Operation — Resetting File Numbers

- 1 Turn on the power and set the mode select dial to "SET UP".
- 2 Press Up or Down on the directional keypad to select [FILE NO.], then press Right on the directional keypad.
- 3 Press Up on the directional keypad to select [OK], then press the  button to complete the setting.

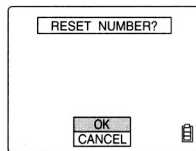
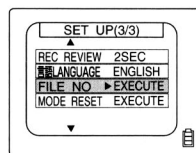

[MODE RESET] Restoring Default Settings of Functions

Use this mode when restoring modes and menus to default settings.

Operation — Restoring the default settings

- 1 Turn on the power and set the mode select dial to "SET UP".
- 2 Press Up or Down on the directional keypad to select [MODE RESET], then press Right on the directional keypad.
- 3 Press Up on the directional keypad to select [EXECUTE], then press the  button to complete the setting.

For default settings of each menu, see page 100.

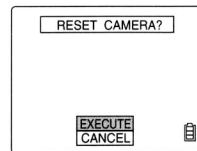
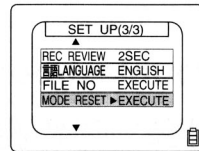

Appendix

Troubleshooting

Symptom	Cause	Remedy
LCD doesn't appear.	Battery power is depleted or the battery pack is not inserted.	Replace the battery pack with a new one.
	The auto-off function has operated to turn power off. (page 84)	Press the POWER button again to turn power ON.
	Setting of power-save function may cause camera to enter sleep mode when it is inactive for set period.	Press the shutter button halfway, or press any other function buttons to return the camera to normal operating condition. Since camera response differs depending on the setting of the Power-Save function, consult page 84 for details.
	The LCD monitor is turned off.	Press the DISP button to turn on the LCD monitor.
	A strong magnet or other electromagnetic generator is located too near the camera.	Move the camera away from the magnet or electromagnetic field. After that, the LCD doesn't display, remove the battery pack once and reinstall it in the original location.
The number of images recordable does not change when a picture is taken.	The file size of the recorded image was very small.	File size and number of pictures recordable differ depending on the image quality setting and subject conditions; not a malfunction.
Image cannot be erased; "🔑" mark appears.	The image is protected.	Release the image protect function. (page 72)

Symptom	Cause	Remedy
The number of recordable images didn't change when an image was erased.	The size of the erased image file was very small.	File size and number of recordable pictures differ depending on image quality mode and subject conditions; not a malfunction.
The camera feels hot.	Large power consumption occurs during use of the LCD monitor; the camera may feel warm when the LCD monitor is used for a long period of time.	This in itself is not a malfunction, but the camera should be allowed to cool down before continuing use.
Caution LED flashes slowly.	The flash is charging.	Remove your finger from the shutter release button and wait for the flashing to stop.
Caution LED flashes rapidly.	Camera shake warning, indicating that a slow shutter speed has been selected.	Use a tripod or other means to stabilize the camera.
Focus can't be set. Standby LED flashes. Focus mark flashes.	The subject being shot is difficult to bring into focus. (page 40)	Use the focus lock function to lock the focus on a part of the subject with higher contrast before final composition of the image. (page 40)
Everything appears as a white screen.	The setting is adjusted to over-exposure.	Either turn off the long exposure or reset the mode settings.
Image cannot be rotated, set for DPOF, protected, resized or audio recorded. The message "WRITE PROTECT" appears.	The write protect switch is set (SD memory card).	Release the SD memory card's write protect lock, or insert a different memory card. (page 15)
Much noise is found on the image.	Noise occurs easily by increasing the ISO sensitivity or setting to the long exposure time.	Remove noise using the retouching software or use a lighting.
Some images that had not been played back in the camera were printed in the print shop.	Resized images or images recorded in the PC are suspected.	Select the images you want to print following one of the procedures below. Set printing (DPOF). (A resized image cannot be set for DPOF). Erase unnecessary images using the PC.
When the camera and the PC are connected, [Removable Disk] or [Untitled Folder] cannot be displayed.	The USB cable is improperly inserted.	Insert the USB cable securely.
	The driver is not installed or the driver installation is failed.	Follow the procedure shown in the section "Uninstalling the USB Driver and Remedies" (page 35).

Messages and Remedies

Message	Cause	Remedy
"MEMORY CARD FULL"	The memory card has insufficient free memory available.	Insert a new memory card, or erase unneeded images on the current card. Or, change the setting of image size or quality.
"NO CARD"	No memory card is loaded.	Insert a memory card.
"WRITE PROTECT"	The write protect switch is activated (SD memory card).	Release the write protect switch, or insert a different memory card. (page 15)
"CARD ERROR"	The inserted memory card has been formatted in a different camera or information device.	Reformat the memory card in the camera. (page 84)
	The memory card format is not compatible with the camera.	Insert another memory card or format it.
	Memory card is not loaded correctly.	Remove the memory card and reload it correctly.
"NO IMAGE"	Nothing is recorded on the memory card.	<ul style="list-style-type: none"> ● Insert a memory card with recorded image data. ● Take a picture.
"CANCEL PRINT"	Printing is cancelled from the printer or camera.	Return the menu of [Direct Print] by selecting [Check] or [Cancel]. If you restart printing, check the status of the printer or the camera. If you cannot print the images, turn off the powers of the camera and the printer once and turn on them. After that, restart printing.
"PRINTER BUSY"	Start printing from the camera when the printer is starting or operating.	
"PRINTER ERROR"	Printer has any trouble, such as ink shortage or paper jam.	
"NO PLAYBACK"	It appears when the image is broken or the image was restored in the PC.	Take a picture again.

List of Menus and Icons Displayed on the LCD Monitor

Display when the Camera “” or Movie “” mode is selected

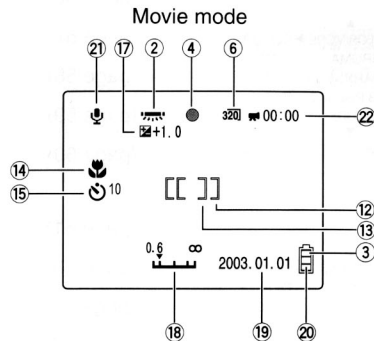
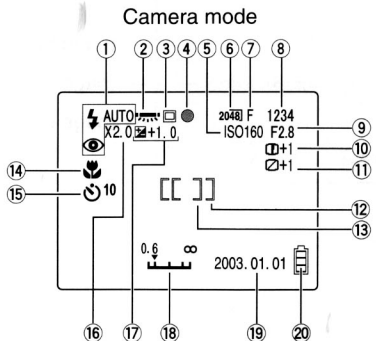

- ① Flash mode (page 44)
- ② White balance mode/color mode (page 54/page 56)
- ③ Metering mode (page 65)
- ④ Focus mark (lights when focus is set)
- ⑤ ISO Sensitivity (page 64)
- ⑥ Pixels (page 50)
- ⑦ Image quality (page 51)
- ⑧ Number of recordable images
- ⑨ Auto-Exposure mode (page 60)
- ⑩ Sharpness (page 58)
- ⑪ Chroma (page 57)
- ⑫ Wide AF
- ⑬ Spot AF
- ⑭ Macro/Landscape mode (page 47)
- ⑮ Self-timer (page 49)
- ⑯ Digital zoom/Long Exposure (page 63)
- ⑰ Exposure compensation (page 53)
- ⑱ Focus gauge (appears when focus mode is set to [MF]) (page 61)
- ⑲ Date
- ⑳ Battery indicator
- ㉑ Audio mode (page 55)
- ㉒ Remaining seconds that can be recorded for

Display when the MENU button is pressed

- Menu icons are displayed.

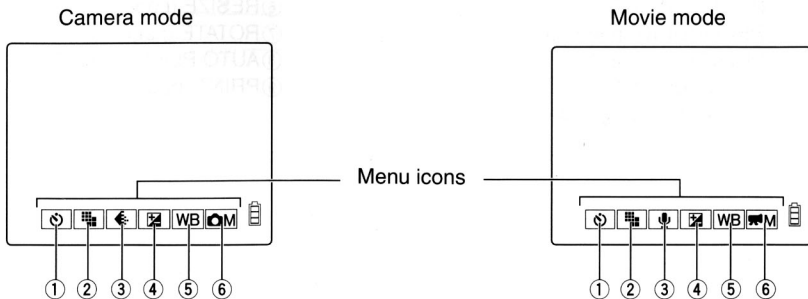

- ① SELF TIMER (page 49)
- ② PIXELS (page 50)
- ③ QUALITY (page 51)
- ④ EXP.COMP (page 53)
- ⑤ WHITE BALANCE (page 54)
- ⑥ SET DETAILS
- ① SELF TIMER (page 49)
- ② PIXELS (page 50)
- ③ SOUND (page 55)
- ④ EXP.COMP (page 53)
- ⑤ WHITE BALANCE (page 54)
- ⑥ SET DETAILS

Display when [SET DETAILS] in Camera “” or Movie “” mode is selected
Menus appear.

Camera mode

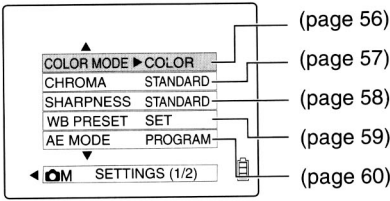

Movie mode

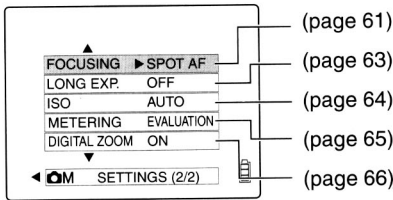
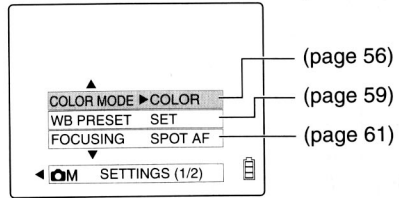

Display when Playback “” mode is selected

Display when the MENU button is pressed

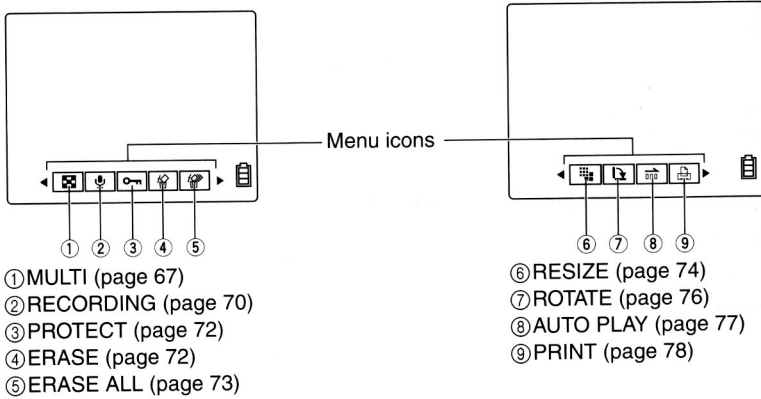

Display when "SET UP" mode is selected

The setup menu is displayed.

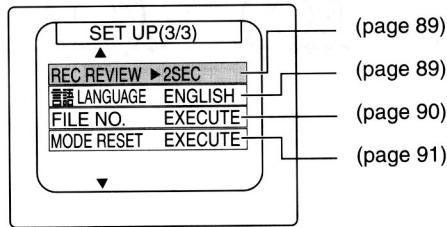
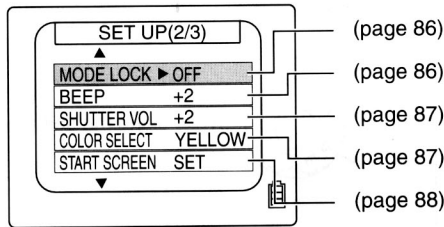
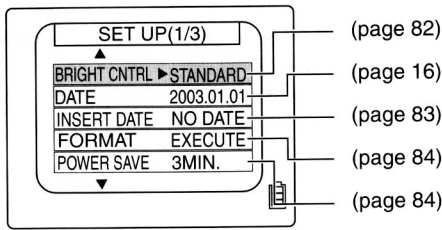

LED Indication and Camera Status

There are 5 LEDs on the camera.

Each LED indicates the status of the camera depending on how it lights or flashes.

Front illumination (Blue / Red)

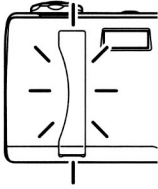

Each LED lights after the power of the camera is turned on, after a mode is selected or when the camera is connected to the PC.

Self-timer LED (Red)

Flashes

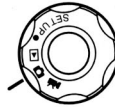
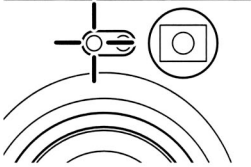

While using the self-timer

Lights

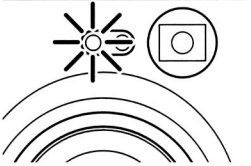

When shooting still images or movies

When Playback "▶" or "SET UP" mode is selected



When the camera is connected to a PC

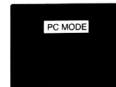

Memory card access LED (orange)

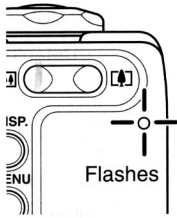

Flashes while the camera is accessing the memory card, such as recording images to memory card or reading data.

- While the LED is flashing, do not open the memory card door or remove the memory card. Failure to do so might break the data.

Standby LED (green)

Camera "📷" mode /Movie "🎥" mode	<p>Lights</p>	Ready to take a picture as the focus is set.
	<p>Flashes</p>	The focus is not set. (But you can still take a picture.)

Caution LED (red)

Camera "📷" mode	<p>Flashes rapidly</p>	As the shutter speed is slow, you need to take care of camera shake.
	<p>Flashes slowly</p>	As the flash is being charged, you need to wait to take the next picture until the LED stops flashing.

List of Menu modes that can be locked and default settings

Mode	Menu	Mode lock	Default
"Camera Mode/ Movie Mode"	Flash	Locked	AUTO
	Macro/Landscape	Locked	Normal shooting
	SELF TIMER	Default	OFF
	PIXELS (L4v)	Previous	2304x1728
	PIXELS (L3v)	Previous	2048x1536
	PIXELS	Previous	320x240
	SOUND	Previous	ON
	QUALITY	Previous	NORMAL
	EXP.COMP	Locked	±0.0
	WHITE BALANCE	Locked	AUTO
	SET DETAILS → COLOR MODE	Default	COLOR
	SET DETAILS → CHROMA	Previous	STANDARD
	SET DETAILS → SHARPNESS	Previous	STANDARD
	SET DETAILS → WB PRESET	Previous	Previous
	SET DETAILS → AE MODE	Previous	PROGRAM
	SET DETAILS → FOCUSING	Previous	SPOT AF
	SET DETAILS → LONG EXP.	Default	OFF
	SET DETAILS → ISO	Previous	AUTO
SET DETAILS → METERING	Previous	EVALUATION	
SET DETAILS → DIGITAL ZOOM	Previous	ON	
"SET UP" Mode	BRIGHT CNTRL	Previous	STANDARD
	DATE	Previous	Previous
	INSERT DATE	Previous	NO DATE
	FORMAT	—	—
	POWER SAVE	Previous	3MIN.
	MODE LOCK	Previous	OFF
	BEEP	Previous	+2
	SHUTTER VOL	Previous	+2
	COLOR SELECT	Previous	YELLOW
	START SCREEN	Previous	Kyocera Logo Screen
	REC REVIEW	Previous	2SEC
	LANGUAGE	Previous	Previous
	FILE NO.	—	—
	MODE RESET	—	—

Locked: When MODE LOCK is set to ON, the setting is saved even if the power is turned off when "MODE LOCK" is set to "ON".

Default: The setting returns to its default mode whether "MODE LOCK" is set to "ON" or "OFF".

Previous: The setting that you set previously is saved whether "MODE LOCK" is set to "ON" or "OFF".

Optional Accessories

AC Adapter AC-74L

You don't have to pay attention to the battery capacity if you use this adapter to do a long playback or connect a PC.

Connecting AC Adapter AC-74L

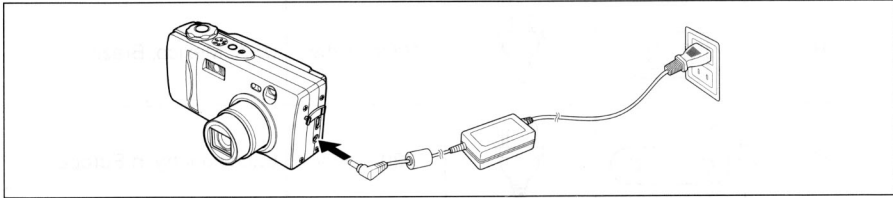









<AC Adapter Handling Precautions>

 WARNING	<ul style="list-style-type: none"> ● Be sure that AC adapter plugs is connected securely before use. Loose plugs and poor contacts can cause generation of heat, fire, and electrical shock. ● Do not attempt to modify the AC adapter's cords, or subject them to unreasonable force. Damage to the cords can cause fires and electrical shock. If cords become so damaged that their wire cores are exposed, discontinue use and consult your dealer or Kyocera/Yashica Service Center. ● Do not attempt to remove covers, disassemble, repair or modify your AC adapter, since dangerous electrical shock could result. ● AC adapter plugs that have become laden with dirt or household dust should not be used or approached with metal objects, since electricity might be transmitted through the metal, causing fire or personal electrical shock. In the event of heavy soiling of a plug, remove it from its outlet and clean away the dirt before reusing. ● In the event that an AC adapter plug emits smoke or unusual smell or sound, or if it is damaged by impact or falling, cease use immediately. Continuing to use a damaged plug could result in fire danger. In the event of damage to a plug, consult your dealer or Kyocera/Yashica Service Center. ● Do not connect the AC adapter to any sources of power other than a household AC outlet (AC 100V to 240V; 50/60Hz). Using the adapter with other voltages or ratings may cause the hazard of fire or electrical shock.
---	---

 CAUTION	<ul style="list-style-type: none"> ● Use the designated AC adapter. Using other adapters may result in accidents and fire danger. ● Never attempt to splice the AC adapter cord, or subject it to severe twisting, bending, or stretching. ● Do not handle the AC adapter with wet hands, since personal electrical shock could result. ● Always grasp the plug body (not cord) when removing the AC adapter plugs from camera and power outlet. Pulling on the cords could cause breakage or other damage to the wires, resulting in danger of fire or electrical shock. ● If you observe any damage to the AC adapter, including broken wires and faulty plug contacts, discontinue use and consult your dealer Kyocera/Yashica Service Center.
---	--

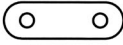
- Prolonged use may cause the AC adapter to feel warm; this is a normal phenomenon and not a malfunction.
- When not using the AC adapter for an extended period of time, first remove the plug from the camera body, then disconnect the adapter from its AC outlet.
- If you wish to use the AC adapter while batteries are loaded in the camera, first set the camera's power switch to OFF, then connect the AC adapter before turning on the camera again.
- The AC adapter has been designed for exclusive use with this camera. To prevent the danger of fire and electrical shock, do not use the adapter with products other than the specific digital camera for which it was designed.

There are 4-type AC cables.

Shape of Plug Socket			Voltage	Country
Type	Terminal front	Terminal side		
A			100v - 125v	Japan
B			100v - 125v	USA, Mexico, Brazil, etc.
C			220 - 240v	Each country in Europe
BF			220 - 240v	England, Singapore, etc.

- If you use the adapter other than the countries specified in the table, check the voltage and shape of plug socket for the country.
- In some regions, more than one type of plug sockets can be used. (For example, you can use C type as well as BF type in a certain area of England.)

Pay attention to your selection of [LONG EXP.] and [ISO].

Some combination of [LONG EXP.] and [ISO] menu icons cannot be selected as shown in the table below.

LONG EXP.		ISO	Menu items			
			AUTO	80	160	320
Menu items	OFF		○	○	○	○
	[LT2S] 2 SEC		○	○	○	○
	[LT4S] 4 SEC		○	○	○	×
	[LT8S] 8 SEC		○	○	×	×

- Selectable combination
- × Unselectable combination

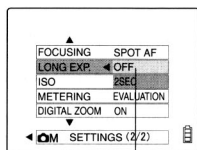

Menu items

In this case, the unselectable menu icons are not be displayed on the screen and cannot be selected.

For example, if the [ISO] is set to 320, "4 SEC" and "8 SEC" cannot be displayed in [LONG EXP.] mode.

Specifications

L4v: Finecam L4v

L3v: Finecam L3v

Type:	Digital still camera with record, playback, and erase modes.	
Recording media:	SD Memory Card, Multi Media Card (MMC)	
Recording Capacity (Guideline) and Image Dimensions in Pixels (when using 16 MB SD Memory Card, all pictures taken in the same mode):		
2304×1728 (L4v only)	About 7 to10 (Fine)	About 14 to 19 (Normal)
2048×1536 (L3v only)	About 9 to 12 (Fine)	About 17 to 24 (Normal)
1600×1200	About 14 to 20 (Fine)	About 27 to 36 (Normal)
1280×960	About 21 to 29 (Fine)	About 39 to 52 (Normal)
640×480	About 67 to 85 (Fine)	About 104 to 123 (Normal)
Movies 320×240	About 1 to 2 (30 seconds each)	
Movies 160×120	About 1 to 2 (120 seconds each)	
Image Format:	Complies with JPEG standard (Exif ver2.2), DCF Standard (Design rule for Camera File system), supports DPOF	
Effective pixels:	L4v: 4.03 mega pixels, L3v: 3.22 mega pixels	
Pickup Device:	L4v 1/2.5" square-pixel interlace readout system CCD 4,230,000 pixels gross L3v 1/2.7 square-pixel interlace readout system CCD 3,340,000 pixels gross	
Lens:	f = 5.8 mm to 17.4 mm (L4v: 35 mm camera equivalent to about 35 mm to 105 mm, L3v: 35 mm camera equivalent to 38 mm to 115 mm) 3x zoom lens, F2.8 to 4.7	
Focusing Range (measured from front lens surface):	About 64.5 cm* ² to infinity ∞ In Macro Mode: About 24.5 cm* ¹ to 64.5 cm* ² (fixed to wide-angle position)	
Exposure Control/Metering Method:	CCD multi area evaluation, center weighted, spot metering	
Control Method:	Programmed AE, Aperture Priority AE, Long Exposure mode	
Exposure Compensation:	+2.0 EV to -2.0 EV (in 1/3 steps)	
Aperture Control:	Automatic, or manually settable to F2.8, F7.5*, *:brightness converted F value	
Automatic Exposure Linkage Range:	LV6 to LV16	
White Balance:	Automatic, Manual (Preset, Bright sun, Incandescent light bulbs, Cloudy weather, Fluorescent light)	
Shutter:	CCD electronic shutter and programmed electronic shutter with independent aperture control (1 sec to 1/2000 sec, 2 sec, 4 sec, 8 sec).	
Focusing Control:	Video feedback auto focusing and manual focusing	
Viewfinder:	True image zoom viewfinder Field of view ratio: 80% or more (within 3 m) Magnification: About 0.3x (wide angle) to about 0.8x (telephoto)	

Flash:	Built-in flash, recycling time about 8 seconds(with new batteries, at room temperature, based on our testing standards). Flash range about 64.5 cm* ² to 2.5 m (zoom set at wide, ISO80). * ¹ :About 20 cm away from the front side of the lens * ² :About 60 cm away from the front side of the lens
Camera modes:	Flash modes (auto flash, red eye reduction, fill in flash, flash off, night backdrop, * ³ red eye reduction forced flash); macro mode; landscape mode; color modes (color, B&W, sepia), chroma; sharpness; white balance (auto, daylight, tungsten, cloudy, fluorescent, preset); AE modes (programmed, F2.8; F7.5); focus (Wide AF, Spot AF, MF); long exposure (OFF, 2 sec, 4 sec, 8 sec); sensitivity (AUTO, ISO80, ISO160, ISO320); metering modes (evaluation, center weighted, spot); Digital zoom ON OFF * ³ Settable during long exposure
Movie Modes:	Macro mode; landscape mode; color modes (color, B&W, sepia); white balance (auto, daylight, tungsten, cloudy, fluorescent, preset); focus (Wide AF, Spot AF, MF);audio ON OFF
Playback modes:	Multiple image display; audio recording; protect; erase (single image); all erase (erase all images in folder \DCIM); rotation (right left 90 degrees); slide show; DPOF setting; Resizing
Setup modes:	Brightness control; date; date inserting; memory card format; auto power off setting function ON OFF and time setting (until camera power turns off automatically); mode lock ON OFF (preserves mode setting data); beep volume setting; shutter volume setting; select color (Purple, Red, Yellow, Blue); startup screen setting; REC Review On Off; display language setting (Japanese, English, French, German, Spanish, Chinese); file number reset; default reset
Other:	USB Direct Print* ⁴ , PC mode (displayed on the LCD monitor in connecting the camera and PC.) * ⁴ It supports the USB DIRECT-PRINT proposed by Seiko Epson.
LCD monitor:	Built-in 2.5", 110,000-pixels TFT color LCD monitor, size: 474x234 pixels.

<Display>

LCD monitor display:	Remaining battery capacity; camera and movie mode settings (Self-timer mode, flash mode, macro landscape mode, white balance mode, AE mode, focus, long exposure, sensitivity, metering mode, sound mode, chroma, sharpness), number of recordable images; remaining recordable seconds of movie; digital zoom setting (L4v: $\times 1.3 \times 1.6 \times 2.0 \times 3.0 \times 4.0$, L3v: $\times 1.3, \times 1.6, \times 2.0$); date (appears for 3 seconds after power is turned on only); focus frame; SD memory card write protect status (appears only when write protect is enabled); image recorded (still, movie); playback mode setting (multi image, audio recording, protect, erase, all erase, rotate, slide show, DPOF setting, resizing); setup mode (LCD brightness, date, date inserting, format, auto off, mode lock, beep volume, shutter volume, select color, startup screen, REC view, display language, file number reset, default reset)
Self-timer LED (red):	Self-timer LED (red): lights to indicate self-timer operation, recording completion, connection to a PC, playback mode, set up mode or movie recording
Card access LED (orange):	Front LED: lights when the camera is turned on and goes off automatically, when starting operation or when selecting mode
Standby LED (green):	lights to indicate focus display
Caution LED (red):	lights to indicate flash charging or camera shake warning
Front illumination:	lights when the camera is turned on and goes off automatically, when starting operation or when selecting mode

<Input, Output>

Input output connector:	External power input connector; USB connector
-------------------------	---

<Battery Power>

Power:	Lithium battery pack (CR-V3), 2 AA nickel metal hydride rechargeable battery or 2 AA alkaline cells can be used as well as the dedicated AC adapter.
Battery capacity:	<p>L4v: Number of recordable images (using 50% flash, 2304\times1728, Normal mode)</p> <p style="padding-left: 40px;">LCD monitor ON about 160</p> <p style="padding-left: 40px;">LCD monitor OFF about 170</p> <p>L3v: Number of recordable images (using 50% flash, 2048\times1536, Normal mode)</p> <p style="padding-left: 40px;">LCD monitor ON about 160</p> <p style="padding-left: 40px;">LCD monitor OFF about 170</p> <p>Continuous playback time about 200 minutes (using LCD monitor)</p> <p>(All values assume new batteries, room temperature, using the supplied lithium battery CR-V3, based on our testing standards)</p>

<Other>

Ambient operating temperature:	0°C to 45°C
Dimensions:	112.5 (Width) x 54.5 (Height) x 35 (Depth) mm (not including protruding parts)
Weight:	About 170 g (not including memory card or battery pack)

*All descriptions and specifications are subject to change without notice.