

**Canon**

# MULTIMEDIA PROJECTOR SX6/SX60/X600

## User's Manual



Safety Instructions

Before Use

Setting Up the Projector

Projecting an Image from the Computer

Projecting an Image from AV Equipment

Useful Functions Available During a Presentation

Setting Up Functions from Menus

Maintenance

Troubleshooting

Appendix

Index

  
**AISYS**  
Aspectual Illumination  
System

**ENG**

# Quick Reference – How to start projection



## Computer

- 1. Install the projector.** P28-29
  - Install the projector at the desired distance from the screen.
  - Install batteries in the remote control (P26)

---

- 2. Connect the projector.** P32-34
  - Connect the projector and the computer with a cable.

---

- 3. Turn on the projector.** P35-38
  - Connect the power cord and turn on the projector.
  - Adjust the height of the projecting image (P38).
  - Select a display language when turning on the projector for the first time (P36).

---

- 4. Set up the computer.** P39-40
  - Turn on the computer and set the resolution.

---

- 5. Select the input signal by pressing the  button.** P43-45
  - Select an appropriate input signal in accord with the signal from the computer.

---

- 6. Press the  button.** P41
  - Adjust the input signal, focusing, keystone distortion, etc. automatically with the auto setup function.

---

- 7. Press the  button.** P49
  - Optimize the input signal with the auto PC function (Skip this step if the projector is projecting an image properly.)

---

- 8. Select the image mode with the  button.** P50-51
  - Select an appropriate image mode for projection.
  - Specify the aspect ratio or display area in the [Aspect] menu as required (P52, 78).

---

- 9. Start the presentation.** P66-71
  - Set the useful functions available during the presentation from the remote control.

---

- Finishing the projection...  
**Turn off the projector** P53-54
  - Turn off the projector and unplug the power cord.



## AV Equipment

- 1. Install the projector.** P28-29
  - Install the projector at the desired distance from the screen.
  - Install batteries in the remote control (P26)

---

- 2. Connect the projector.** P56-58
  - Connect the projector and the AV equipment with a cable\* (see P34 for the instruction on connecting a audio cable).

---

- 3. Turn on the projector.** P35-38
  - Connect the power cord and turn on the projector.
  - Adjust the height of the projecting image (P38).
  - Select a display language when turning on the projector for the first time (P36).

---

- 4. Set up the AV equipment.**
  - Turn on the AV equipment and play the video image.

---

- 5. Select the input signal by pressing the  button.** P61-63
  - Select DIGITAL VIDEO as the input signal for a digital video image.\*  
For the other video image, go to step 6.

---

- 6. Press the  button.** P60
  - Adjust the input signal, focusing, keystone distortion, etc. automatically with the auto setup function.

---

- 7. Select the image mode with the  button.** P50-51
  - Select an appropriate image mode for projection.
  - Specify the aspect ratio or display area in the [Aspect] menu as required (P64, 78, 79).

---

- Finishing the projection...  
**Turn off the projector** P53-54
  - Turn off the projector and unplug the power cord.

\* Connect the projector and the AV equipment with a HDMI/DVI cable to project a digital video image.

# Features of the Multimedia Projector SX6/SX60/X600

---

Thank you for purchasing a Canon projector.

The MULTIMEDIA PROJECTOR SX6/SX60/X600 are high-performance projectors which project the data from the computer and the moving picture from the DVD player to the big screen.

## Major Features

### Smooth and Beautiful Imaging Capability

Incorporation of AISYS, Canon's unique optical engine, and LCOS (Liquid Crystal On Silicon) achieves high brightness, high contrast ratio, and smooth and beautiful lattice-free images.

### High Brightness of 3500 Lumen (SX6/X600)

This projector provides high brightness of the best-in-class\* 3500 lumen.

\* Portable projectors less than 5 kg.

### Super-Silent Operation of 27dB\* (SX60)

This projector achieves super-silence operation as low as 27dB which creates a comfortable atmosphere where you can concentrate on watching a movie.

\* At a silent mode.

### Native SXGA+ Resolution (SX6/SX60)

Native SXGA+ resolution (1400 by 1050 dots) ensures projection of a high-quality image in a wider projection area with a high degree of resolution.

\* X600 supports native XGA resolution (1024 by 768 dots).

### High-powered 1.7X Zoom Lens

1.7X zoom aspheric lens can project a 100-inch image when placed 3 m (9.8') to 4.9 m (16.0') away.

### "Auto Setup Function" for Easy Installation

The "Auto Setup Function" allows you to install the projector easily by automatically adjusting focus and keystone distortion.

### Adobe® RGB Color Space Compatibility (SX6)

AdobeRGB color space compatibility achieves faithful color reproduction.

### "Home Cinema" Mode Reproducing the Atmosphere of a Movie Theater (SX60)

You can reproduce the atmosphere of a full-scale movie theater in your home by selecting "Home Cinema" from the image mode.

### "Off and Go" Function Allowing the Carriage Immediately After the Use

You can carry the projector immediately after the use because the cooling fan keeps rotating even if the power cord is removed from the electrical outlet.

### Compact and Easy-to-use Wireless Remote Control

It comes with a wireless remote control which allows you to control all functions of this projector.

# Supplied Manuals and Symbols Used in This Manual

## Supplied Manuals

### User's Manual (This Document)

This is a universal manual for the projector, SX6/SX60/X600. This manual provides detailed information on how to use the projectors. Read this manual thoroughly to make the most of your projector and ensure safety.

### Quick Start Guide (Another Document)

This guide shows an outline flowchart of the work necessary to start up, adjusting, and turn off the projector.

## Symbols of Button Operations

This projector can be operated using buttons on the remote control or the top control on the main unit. In this manual, the button operation is shown as below.

**Adjusting the Focus**

You can adjust the focus.  
Follow the steps below to adjust the focus manually if the Auto setup function (Auto) does not adjust the focus appropriately.

1 Press the [FOCUS] button.  
The Focus adjustment window appears.

Indicates the button operation on the top control.

Indicates the button operation on the remote control.

Indicates the button to be pressed.

## Symbols Used in This Manual

Meanings of the following symbols used in this manual are as follows:

	A precaution about operation or restriction is given here.
	An important matter that you should be aware of before operation or a useful tip is provided here.

## COPYRIGHT NOTICE

- Microsoft, Windows, Windows Me, Windows 2000 and Windows XP are registered trademarks of the U.S. Microsoft Corporation in the U.S. and other countries.
- XGA, SXGA, SXGA+, and UXGA are U.S. registered trademarks of IBM Corporation.
- Macintosh is a trademark of the U.S. Apple Computer, Inc. registered in U.S. and other countries.
- Adobe is a trademark of Adobe systems Incorporated.
- Other company names and product names are registered trademarks or trademarks of the respective companies.
- The "HD ready" logo is a trademark of EICTA.

# Safety Instructions

Before operating this projector, read this manual thoroughly in order to operate the projector properly.

This projector offers many convenient features and functions. Operating the projector properly enables you to manage those features and maintain it in good condition for a long period.

Improper operation may result in not only reducing the product-life, but also malfunctions, fire hazards, or other accidents.

If your projector is not operating correctly, read this manual again, check operations and cable connections, and try the solutions shown in the "Troubleshooting" section at the end of this booklet. If the problem still persists, contact the service center or the dealer where you purchased the projector.



**CAUTION**  
**RISK OF ELECTRIC SHOCK**  
**DO NOT OPEN**



**CAUTION: TO REDUCE THE RISK OF ELECTRIC SHOCK, DO NOT REMOVE COVER (OR BACK). THERE ARE NO USER-SERVICEABLE PARTS INSIDE EXCEPT LAMPS. REFER SERVICING TO QUALIFIED SERVICE PERSONNEL.**



THIS SYMBOL INDICATES THAT DANGEROUS VOLTAGE CONSTITUTING A RISK OF ELECTRIC SHOCK IS PRESENT WITHIN THIS UNIT.



THIS SYMBOL INDICATES THAT THERE ARE IMPORTANT OPERATING AND MAINTENANCE INSTRUCTIONS FOR THIS UNIT IN THE OWNER'S MANUAL.

## CAUTION

Not for use in a computer room as defined in the Standard for the Protection of Electronic Computer/Data Processing Equipment, ANSI/NFPA 75.

## Safety Precautions

**WARNING: TO REDUCE THE RISK OF FIRE OR ELECTRIC SHOCK, DO NOT EXPOSE THIS APPLIANCE TO RAIN OR MOISTURE.**

- This projector projects intense light from the projection lens. Do not stare directly into the lens if possible, as doing so may result in eye damage. Be especially careful that children do not stare directly into the beam.
- Install the projector in an appropriate position. Installing the projector in an inappropriate position may result in a fire hazard.
- Allow for appropriate space above, beside and behind of the projector cabinet for allowing air circulation and cooling of the projector. Minimum clearances must be maintained. If the projector is to be built into a compartment or similarly space, the minimum distances must be maintained. Do not cover the ventilation slot on the projector. Heat build-up can reduce the service life of your projector, and can also be dangerous.

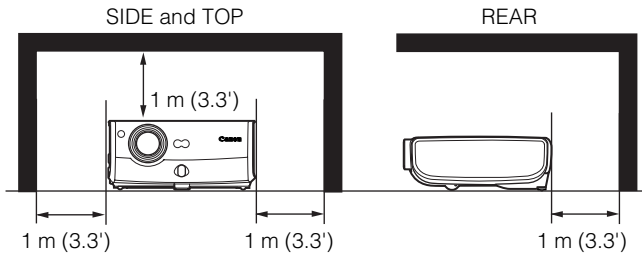

- Do not put any flammable objects or spray cans near the projector, as the hot air exhausted from the ventilation holes may result in an explosion.
- If the projector is not to be used for an extended period of time, unplug it from the power outlet.

---

## READ AND KEEP THIS OWNER'S MANUAL FOR LATER USE.

All the safety and operating instructions should be read before beginning to operate the product.

Read all of the instructions given here and retain them for later use. Unplug this projector from the AC power supply before cleaning. Do not use liquid or aerosol cleaners on the projector. Use a damp cloth for cleaning.

Follow all warnings and instructions marked on the projector.

For added protection of the projector during a lightning storm, or when it is left unattended or unused for long periods of time, unplug it from the wall outlet. This will prevent damage due to lightning and power surges.

---

Do not expose this unit to rain or use near water... for example, in a wet basement, near a swimming pool, etc...

Do not use attachments not recommended by the manufacturer as they may result in hazards.

Do not place this projector on an unstable cart, stand, or table. The projector may fall, causing serious injury to a child or adult, and serious damage to the projector. Use only with a cart or stand recommended by the manufacturer, or sold with the projector. Wall or shelf mounting should be carried out in accordance with the manufacturer's directions, and should use a mounting kit approved by the manufacturers.

An appliance and cart combination should be moved with care. Sudden stops, excessive force, and uneven surfaces may cause the appliance and cart combination to overturn.

Slots and openings in the back and bottom of the cabinet are provided for ventilation, to insure reliable operation of the equipment and to protect it from overheating.

The openings should never be covered with cloth or other materials, and the bottom opening should not be blocked by placing the projector on a bed, sofa, rug, or other similar surface. This projector should never be placed near or over a radiator or heat register.

This projector should not be placed in a built-in installation such as a book case unless proper ventilation is provided.





---

Never push objects of any kind into this projector through cabinet slots as they may touch dangerous voltage points or short out parts that could result in a fire or electric shock. Never spill liquid of any kind onto the projector.

Do not install the projector near the ventilation duct of air-conditioning equipment.

This projector should be operated using only the type of power source indicated on the marking label. If you are not sure of the type of power supplied, consult your authorized dealer or local power company.

Do not overload wall outlets and extension cords as this can result in fire or electric shock. Do not allow anything to rest on the power cord. Do not locate this projector where the cord may be damaged by people walking on it.

Do not attempt to service this projector yourself as opening or removing covers may expose you to dangerous voltages or other hazards. Refer all servicing to qualified service personnel.

Unplug this projector from the wall outlet and refer servicing to qualified service personnel under the following conditions:

- a. When the power cord or plug is damaged or frayed.
- b. If liquid has been spilled into the projector.
- c. If the projector has been exposed to rain or water.
- d. If the projector does not operate normally after following the operating instructions. Adjust only those controls that are covered in the operating instructions as improper adjustment of other controls may result in damage and will often require extensive work by a qualified technician to restore the projector to normal operating condition.
- e. If the projector has been dropped or the cabinet has been damaged.
- f. When the projector exhibits a distinct change in performance-this indicates a need for servicing.

When replacement parts are required, be sure the service technician uses replacement parts specified by the manufacturer that have the same characteristics as the original parts. Unauthorized substitutions may result in fire, electric shock, or injury.

Upon completion of any service or repairs to this projector, ask the service technician to perform routine safety checks to determine that the projector is in safe operating condition.

## AC Power Cord Requirement

The AC Power Cord supplied with this projector meets the requirements for use in the country you purchased it.

### AC Power Cord for the United States and Canada:

The AC Power Cord used in the United States and Canada is listed by the Underwriters Laboratories (UL) and certified by the Canadian Standard Association (CSA).

The AC Power Cord has a grounding-type AC line plug. This is a safety feature to ensure the plug fits into the power outlet. Do not try to tamper with this safety feature. Should you be unable to insert the plug into the outlet, contact your electrician.

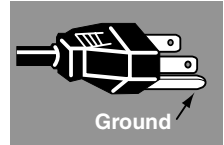

### THE SOCKET-OUTLET SHOULD BE INSTALLED NEAR THE EQUIPMENT AND EASILY ACCESSIBLE.

#### NOTE FOR CUSTOMERS IN THE US

(Hg) LAMP(S) INSIDE THIS PRODUCT CONTAIN MERCURY AND MUST BE RECYCLED OR DISPOSED OF ACCORDING TO LOCAL, STATE OR FEDERAL LAWS.



#### European Union (and EEA) only

This symbol indicates that this product is not to be disposed of with your household waste, according to the WEEE Directive (2002/96/EC) and your national law. This product should be handed over to a designated collection point, e.g., on an authorized one-for-one basis when you buy a new similar product or to an authorized collection site for recycling waste electrical and electronic equipment (EEE). Improper handling of this type of waste could have a possible negative impact on the environment and human health due to potentially hazardous substances that are generally associated with EEE. At the same time, your cooperation in the correct disposal of this product will contribute to the effective usage of natural resources. For more information about where you can drop off your waste equipment for recycling, please contact your local city office, waste authority, approved WEEE scheme or your household waste disposal service. Your cooperation in the correct disposal of this product will contribute to the effective usage of natural resources and will avoid incurring administrative sanctions according to art. 50 and following of Italian legislative decree 22/97. For more information regarding return and recycling of WEEE products, please visit [www.canon-europe.com/environment](http://www.canon-europe.com/environment).

(EEA: Norway, Iceland and Liechtenstein)

## **Federal Communication Commission Notice**

Multimedia Projector, Model: SX6/SX60/X600

This device complies with Part 15 of the FCC Rules. Operation is subject to the following two conditions:

- (1) This device may not cause harmful interference, and
- (2) this device must accept any interference received, including interference that may cause undesired operation.

Note: This equipment has been tested and found to comply with the limits for a Class B digital device, pursuant to Part 15 of the FCC Rules. These limits are designed to provide reasonable protection against harmful interference in a residential installation. This equipment generates, uses and can radiate radio frequency energy and, if not installed and used in accordance with the instructions, may cause harmful interference to radio communications. However, there is no guarantee that interference will not occur in a particular installation. If this equipment does cause harmful interference to radio or television reception, which can be determined by turning the equipment off and on, the user is encouraged to try to correct the interference by one or more of the following measures:

- Reorient or relocate the receiving antenna.
- Increase the separation between the equipment and receiver.
- Connect the equipment into an outlet on a circuit different from that to which the receiver is connected.
- Consult the dealer or an experienced radio/TV technician for help.

The cable with a ferrite core provided with the projector must be used with this equipment in order to comply with Class B limits in Subpart B of Part 15 of the FCC rules. Use of a shielded cable is required to comply with class B limits in Subpart B of Part 15 of FCC Rules.

Do not make any changes or modifications to the equipment unless otherwise specified in the instructions. If such changes or modifications should be made, you could be required to stop operation of the equipment.

Canon U.S.A., Inc.

One Canon Plaza, Lake Success, NY 11042, U.S.A.

Tel No. (516) 328-5600

## **Canadian Radio Interference Regulations**

This Class B digital apparatus meets all requirements of the Canadian Interference-Causing Equipment Regulations.

## Lamp Handling Precautions

This projector uses a high-pressure mercury lamp which must be handled carefully and correctly as mentioned below.

- A lamp may explode with a loud sound or burn out due to a shock, scratch, or use beyond its expiry date.
- The lamp life may differ from lamp to lamp and according to the usage environment. There is no guarantee that all lamps will last for the same period of time. Some lamps may fail in a shorter period of time than other similar lamps.
- A lamp gradually becomes darker over time.
- If the projector indicates that the lamp should be replaced (i.e., the LAMP REPLACE indicator lights up twice), the chances of an explosion increase. Replace the lamp with a new one immediately if such is the case.
- Always keep your face away from the exhaust vent so that you are not injured from the gas and broken lamp shards.



### **If a Lamp Explodes**

If a lamp explodes, gas and broken shards may scatter inside the projector and may come out of the exhaust vent. The gas contains toxic mercury. Open windows and doors for ventilation. If you inhale the gas or the shards of the broken lamp contact your eyes or mouth, consult a doctor immediately.

If a lamp explodes, its shards may scatter inside the projector. Ask the Canon service representative to clean and check the inside of the projector and replace the lamp.



### **Disposal of Waste Lamp**

Dispose of the projector's mercury lamp according to local regulations just like the fluorescent lamps.

## **Carrying/Transporting the Projector**

- This projector is a precision machine. Do not subject the projector to strong shocks or vibrations or turn it down.
- Install the lens cap to protect the lens and put the projector in the carrying bag to protect it from dust and scratches on the surface of it when you carry the projector.
- Do not put the projector in the carrying bag until the cooling fan stops rotating. The projector may be damaged due to the heat.
- The carrying bag is not designed to protect the projector from external shocks. When carrying the projector with it put in the carrying bag, do not give a shock to it, drop it, or place anything on it. The projector may be damaged or malfunctioned.
- Do not transport the projector through a courier or transport service with the carrying bag. Put the projector in an impact-resistant transport case if such is the case.

## Installation Precautions

Ensure that the projector is installed with a minimum distance of 1 m (3.3') from its left, right, rear, and top panels to the neighboring object such as a wall.

### Installation

Install the projector correctly. Incorrect installation may cause troubles and accidents.

- Do not tilt the projector more than 20 degrees above and below the horizontal.
- Do not point the projector up or down.
- Do not install the projector vertically.

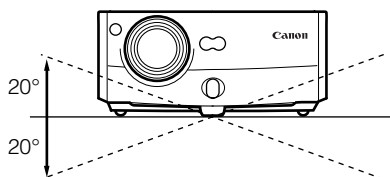

- The projector may be damaged if it is tilted more than 20 degrees above or below.

### Hot Air from Exhaust Vent

- Hot air is exhausted from the exhaust vent. Do not place any object near the exhaust vent.
  - Do not put any spray cans near the vent. The internal pressure increases due to heat, such may result in an explosion.
  - Do not put any metallic object on the projector. It may become hot, resulting in an accident or injury.
  - Do not put anything such as a plant pot near the exhaust vent.
  - Do not put anything near the exhaust vent that may deform or deteriorate due to heat.
  - Do not seat anyone near the exhaust vent.
- The area around the exhaust vent and the cabinet above the exhaust vent become hot. Do not touch these areas, or you may get burnt. In particular, keep children away from these areas.
- Do not put anything that may deform or discolor due to heat on the projector.

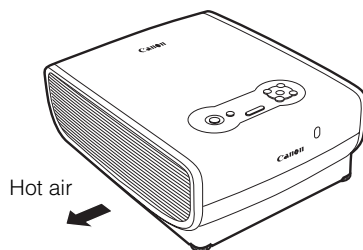

### Do Not Use in the Following Environments

- Do not install the projector in a humid or dusty location or a position where there is a lot of oily or cigarette smoke. Optical parts such as a lens and mirror may be stained, resulting in poor picture quality.
- Do not use the projector in a place subject to either very high or very low temperatures.
  - Operating temperature: +5°C to +35°C
  - Storage temperature: -10°C to +60°C

### Condensation

- If the projector is carried from a cold place to a warm place or the room temperature is raised rapidly, condensation may form on the lens and mirror due to the moisture in the atmosphere, resulting in a blurred picture. Wait until condensation evaporates and normal picture is shown.

# Table of Contents

Quick Reference – How to start projection.....	2
Features of the Multimedia Projector SX6/SX60/X600 .....	4
Supplied Manuals and Symbols Used in This Manual .....	5
Supplied Manuals.....	5
Safety Instructions.....	6
⚠ Safety Precautions.....	7
AC Power Cord Requirement .....	10
Federal Communication Commission Notice .....	11
Canadian Radio Interference Regulations .....	11
⚠ Lamp Handling Precautions .....	12
Installation Precautions .....	13
Table of Contents.....	14
Before Use .....	18
Supplied Accessories .....	18
Part Names.....	20
Preparing the Remote Control.....	26
Setting Up the Projector .....	28
Determining the Distance to the Screen .....	28
Determining the Installation Position .....	29
Projecting an Image from the Computer .....	32
Connecting the Projector to the Computer.....	32
Starting Projection .....	35
Adjusting the Image .....	37
Preparing the Computer .....	39
Performing the Auto Setup .....	41
Adjusting the Focus.....	46
Adjusting Keystone Distortion .....	47
Setting Up the Computer Screen Automatically (AUTO PC).....	49
Selecting an Image Mode (IMAGE) .....	50
Selecting a Screen Mode (Aspect) .....	52
Turning Off the Projector .....	53
Projecting an Image from AV Equipment .....	56
Connecting the Projector to an AV Equipment.....	56
Projecting a Video Image from an AV Equipment.....	59
Performing the Auto Setup .....	60
Selecting a Screen Mode (Aspect) .....	64
Useful Functions Available During a Presentation .....	66
Blackened Out an Image Temporarily .....	66
Muting the Sound .....	66
Freezing the Picture .....	67
Adjusting the Volume .....	67
Showing the Elapsed Time.....	68

Pointing with a Spotlight .....	68
Zooming an Image .....	69
Operating a Mouse with the Remote Control .....	70
Page Up or Down through the Pages .....	71
<b>Setting Up Functions from Menus .....</b>	<b>74</b>
How to Use Menus .....	74
<b>Setting Display Status from the Display Settings Menu .....</b>	<b>78</b>
Selecting a Screen Mode (1) .....	78
Selecting a Screen Mode (2) .....	78
Selecting a Screen Mode (3) .....	79
Selecting an Input Signal Type (1) .....	79
Selecting an Input Signal Type (2) .....	80
Selecting an Input Signal Type (3) .....	80
Adjusting the Total Number of Dots .....	81
Adjusting the Tracking .....	81
Adjusting the Horizontal Position .....	82
Adjusting the Vertical Position .....	82
Adjusting the Number of Horizontal Pixels .....	83
Adjusting the Number of Vertical Pixels .....	83
Performing Progressive Processing .....	84
Selecting a Menu Position .....	84
Performing the Ceiling-mounted/Rear Projection .....	85
Correcting the Screen Color .....	86
Capturing a Logo to Be Projected .....	86
Selecting a Logo Display Position .....	87
Displaying a Logo (No signal screen) .....	87
Displaying a Logo (NO SHOW) .....	88
Selecting a Logo at Startup .....	88
<b>Setting the Image Quality from the Image Adjustment Menu .....</b>	<b>89</b>
Selecting an Image Mode .....	89
Adjusting the Brightness .....	90
Adjusting the Contrast .....	90
Adjusting the Sharpness .....	91
Making a Gamma Correction .....	91
Making Color Adjustment (1) .....	92
Making Color Adjustment (2) .....	92
Making Advanced Color Adjustment (1) .....	93
Making Advanced Color Adjustment (2) .....	93
Making Advanced Color Adjustment (3) .....	94
Reducing the Lamp Brightness .....	94
Resetting the Image Settings .....	95
<b>Setting Various Function with the System Settings Menu .....</b>	<b>96</b>
Setting Auto Setup Function .....	96
Selecting the Power Management Mode .....	96
Skip the POWER Button Operation .....	97

---

Enabling/Disabling the Beep .....	97
Prohibiting the Projector Operation .....	98
Selecting a Display Language .....	98
Enabling/Disabling the Guide Message .....	99
Turning On/Off the LED Illumination .....	100
Setting up the Remote Control .....	100
Setting up the Digital Video Input Signal .....	101
Setting a Password .....	101
Registering a Password .....	102
Resetting the Lamp Counter .....	102
Resetting to the Factory Defaults .....	103
<b>Maintenance .....</b>	<b>106</b>
Cleaning the Projector .....	106
Cleaning and Replacing the Air Filter .....	107
Replacing the Lamp .....	108
<b>Troubleshooting .....</b>	<b>112</b>
WARNING Lamp Flash Patterns .....	112
Symptoms and Solutions .....	113
<b>Appendix .....</b>	<b>118</b>
Supported Computer Signal Types .....	118
Relationship between Screen Size and Projecting Distance .....	119
Glossary .....	120
Specifications .....	123
<b>Index .....</b>	<b>125</b>
<b>Menu Configuration .....</b>	<b>128</b>



# BEFORE USE

Safety Instructions

Before Use

Setting Up the Projector

Projecting an Image from the Computer

Projecting an Image from AV Equipment

Useful Functions Available During a Presentation

Setting Up Functions from Menus

Maintenance

Troubleshooting

Appendix

Index

# Before Use

## Supplied Accessories

Check whether the following accessories are supplied with the projector.

- Remote control

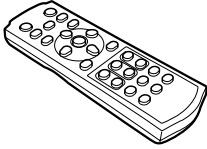

- Batteries (type AAA, two) for remote control

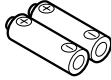

- Computer connection cable (DVI/Mini D-sub, 15-pin) (1.8m/5.9') [YH7-2052]

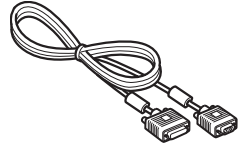

- Power cord (2m/6.6')

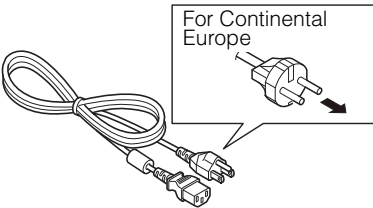

For the U.S.A and Canada

- USB cable (1.8m/5.9') [YH7-2054]

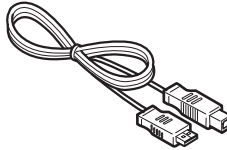

- Component cable (RCA/Mini D-sub, 15-pin) (0.4m/1.3') [YH7-2084]

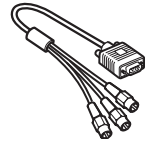

- Carrying bag

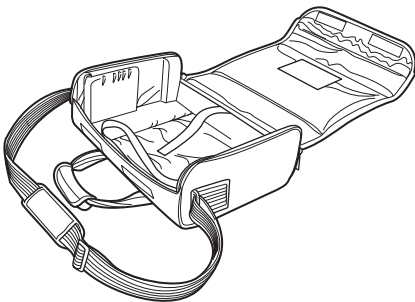

- Lens cap



- Lens cap strap



- User's Manual
- Quick Start Guide
- Warranty card

### Installing the Lens Cap

As shown in the illustration on the right, let the lens cap strap through the hole on the lens cap, and then the lens cap strap insertion hole.

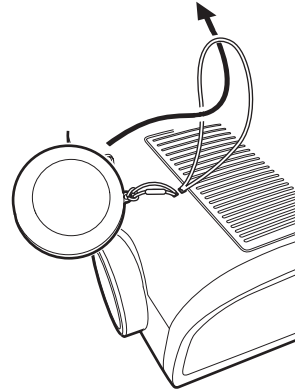

- When the projector is not in use, attach the lens cap to protect the lens from dust and other foreign objects.

### Putting the Projector in the Carrying Bag

As shown in the illustration on the right, put the projector in the carrying bag with its lens faces sideways.

Align the lens with the dimple on the cushioning material.

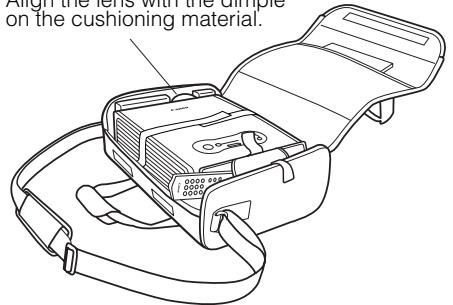

- The lens may be damaged or its function such as zooming or focusing may be malfunctioned.

# Part Names

## Main Unit of Projector

### Front Side

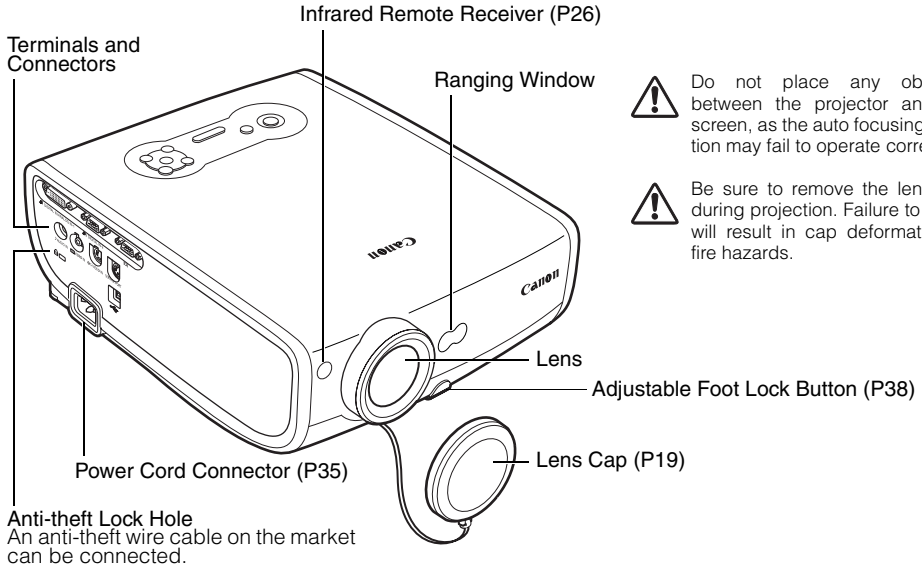

### Rear Side

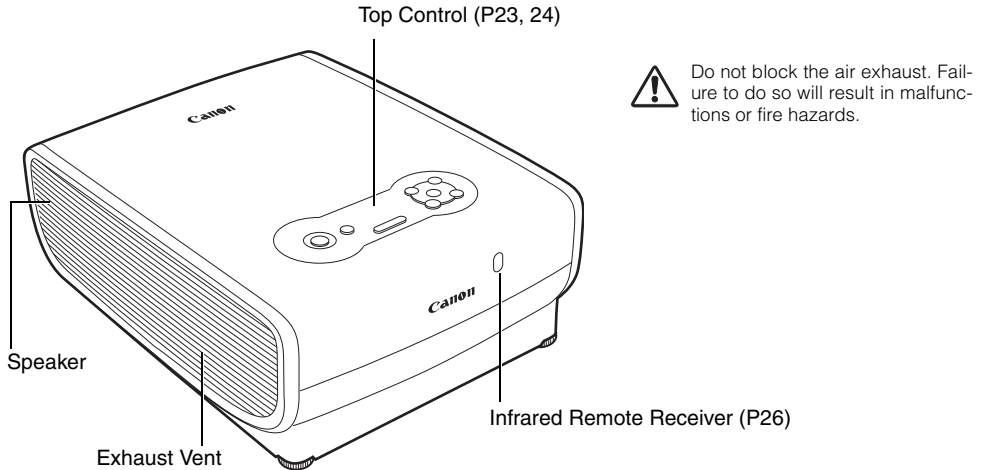

## Bottom Side

Lens Cap Strap  
Insertion Hole

Adjustable Foot (P38)



Do not block the air intake. Failure to do so will result in malfunctions or fire hazards.

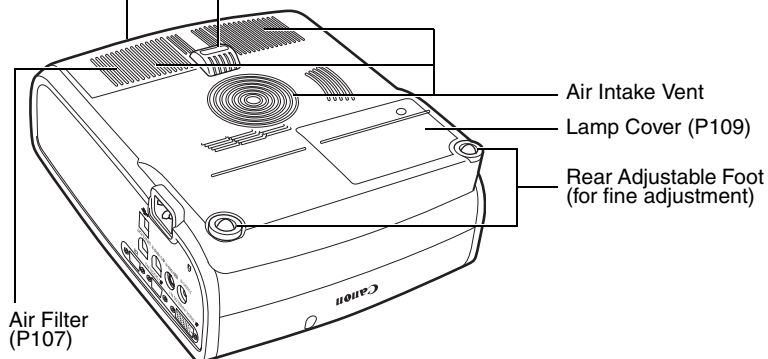

### Mounting the Projector on the Ceiling

You can mount the projector on the ceiling.

You need an optional ceiling mounting bracket (part number: RS-CL06) for it.

Contact the dealer where you purchased the projector for more detailed information.

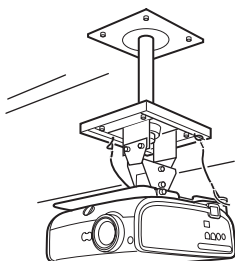

- If you mount the projector on the ceiling, you have to invert the projected image by selecting [Image flip H/V] from the menu (P85).

## Buttons on the Remote Control and Top Control

### Remote Control

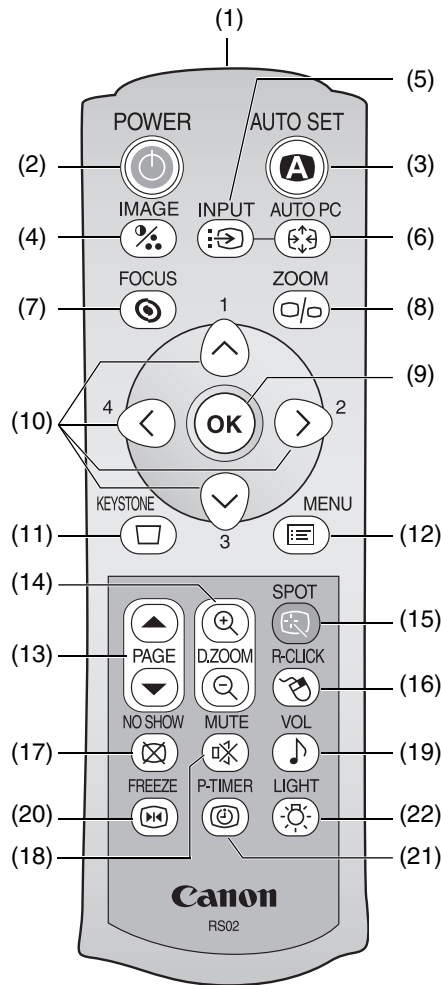

This projector can be operated using buttons on the remote control or the top control on the main unit.

The remote control allows you to operate all functions of the projector.

- (1) **Infrared Remote Emitter**  
Sends a signal to the infrared remote receiver on the main unit.
- (2) **POWER button (P35, 53)**  
Turns the projector on or off.
- (3) **AUTO SET button (P41, 60)**  
Performs auto adjustment on focusing, keystone distortion, screen color correction, and so on (Auto Setup Function).
- (4) **IMAGE button (P50)**  
Switches among image modes (image qualities).
- (5) **INPUT button (P43, 45, 61)**  
Switches among input signals.
- (6) **AUTO PC button (P49)**  
Adjusts tracking and so on automatically in accordance with signal from a computer when ANALOG PC-1 or ANALOG PC-2 is selected.
- (7) **FOCUS button (P46)**  
Adjusts focusing.
- (8) **ZOOM button (P37)**  
Adjusts the image size.
- (9) **OK button (P77)**  
Determines the item selected from the menu. Also works as the left button of a mouse under the USB connection (P70).

## Top Control

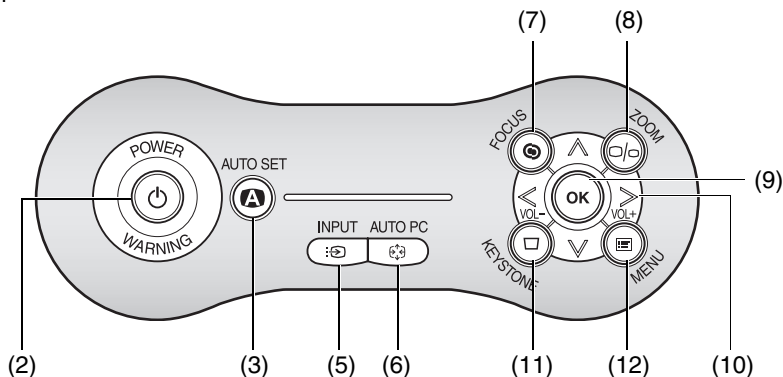

### (10) POINTER button (P75)

Selects the upper, lower, left, or right item in the menu. Also moves the mouse cursor under the USB connection.

On the top control, the [ $<$ ] and [ $>$ ] buttons also turn the volume up and down, respectively (P67).

### (11) KEYSTONE button (P47)

Corrects keystone distortion.

### (12) MENU button (P75)

Displays a menu on the screen.

### (13) PAGE button (P71)

Acts as the Page Up and Page Down keys on the computer keyboard under the USB connection.

Pressing  $\blacktriangle$  scrolls to the previous page and pressing  $\blacktriangledown$  scrolls to the next page.

### (14) D.ZOOM button (P69)

Zooms the image in or out digitally. Pressing  $\textcircled{+}$  enlarges the image and pressing  $\textcircled{-}$  reduces the image.

### (15) SPOT button (P68)

Performs the spot light function.

### (16) R-CLICK button (P70)

Acts as the right button of a mouse under the USB connection.

### (17) NO SHOW button (P66)

Turns the picture into a black image.

### (18) MUTE button (P66)

Mutes the sound.

### (19) VOL button (P67)

Adjusts the sound volume.

### (20) FREEZE button (P67)

Freezes the projected image.

### (21) P-TIMER button (P68)

Displays the time elapsed since this button was pressed.

### (22) LIGHT button (P26)

Turns on or off the lights of the remote control buttons.

## Indicators on the Top Control

### Top Control

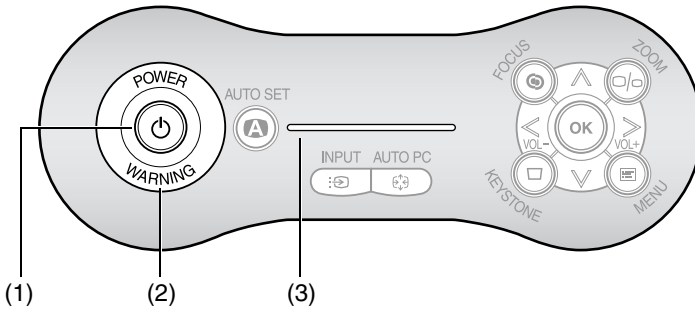

#### (1) POWER indicator (P35, 53, 96)

Indicates the projector status.

Red:	The projector can be turned on.
Flashing red:	The projector is being turned off (the lamp is being cooled).
Green:	The projector is on.
Flashing green:	The projector is being turned on.
Blink between red and green:	The projector is under the power management mode.

#### (2) WARNING lamp (P112)

Flashes red when a problem has been detected on the projector.

#### (3) LED illumination lamp (P100)

Indicate the projector status with 3 blue LEDs.

Blinking from the left:	The projector is being turning on.
Blinking from the right:	The projector is being turned off.
Middle LED flashing slowly:	The image is blackened out (NO SHOW).
Left and right LEDs flashing slowly:	The image is stopped (FREEZE).



## Input Terminals on Main Unit

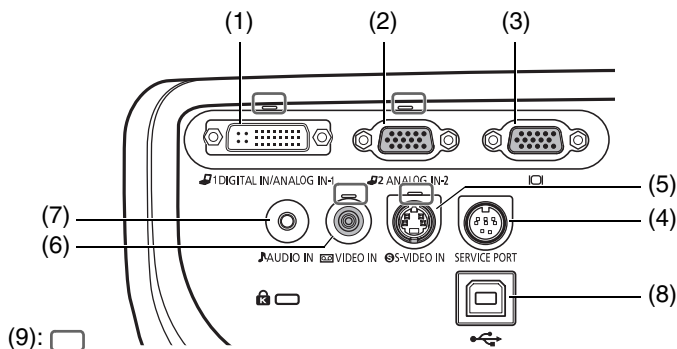

- (1) **Input Terminal-1 (DIGITAL IN/ANALOG IN-1) (P32, 33, 57)**  
 Receives a digital (DIGITAL PC) and analog PC signal (ANALOG PC-1).  
 Receives a digital content image signal (DIGITAL VIDEO).
- (2) **Input Terminal-2 (ANALOG IN-2) (P32, 33, 56)**  
 Receives an analog PC signal (ANALOG PC-2).  
 Receives a component and SCART image signal (COMPONENT/SCART).
- (3) **Monitor Output Terminal (I/O) (P34)**  
 Outputs an analog PC signal to display an image on an external monitor.
- (4) **SERVICE PORT jack**  
 Exclusively used by the service personnel (it is not used normally).
- (5) **S-VIDEO IN terminal (P57)**  
 Receives an S-Video signal from an AV equipment.
- (6) **VIDEO IN terminal (P58)**  
 Receives a composite video signal from an AV equipment.
- (7) **AUDIO IN terminal (P34)**  
 Receives an audio signal from a computer or AV equipment.
- (8) **USB terminal (P70)**  
 Connected to the computer with a USB cable when the remote control is used as the mouse of the computer. (you cannot use this terminal to receive any video image)
- (9) **Input Terminal Indicator (P43, 61)**  
 Indicates the input signal status.  
 Green : The input signal is confirmed and an image is projected.  
 Flashing green : The input signal is confirmed but no image is projected.  
 Off : An input signal is not confirmed (a cable is not connected).

# Preparing the Remote Control

## Installing Remote Control Batteries

- 1** Open the battery compartment lid. Slide the lid with it pressed down.
- 2** Insert batteries. Insert new two AAA-size batteries in the compartment with the + and - poles positioned correctly.
- 3** Replace the compartment lid.

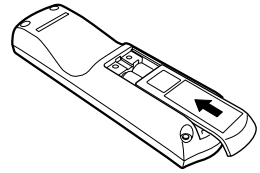
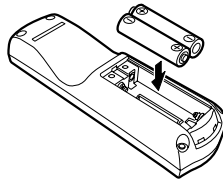
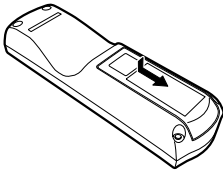

- You can check the batteries of the remote control by pressing the [LIGHT] button. If all buttons on the remote control do not light when the [LIGHT] button is pressed, or buttons are inoperative when you attempt to operate the projector, replace with new batteries.
- It is recommended to check the batteries before a presentation.

## Remote Control Operating Range

Point the remote control to the infrared remote receiver on the front or rear of the projector whenever pressing any button.

- Use the remote control within a distance of approximately 5 m (16.4') from the projector.
- Use the remote control within an angle of 30° in any direction from directly in front of the infrared remote receiver.

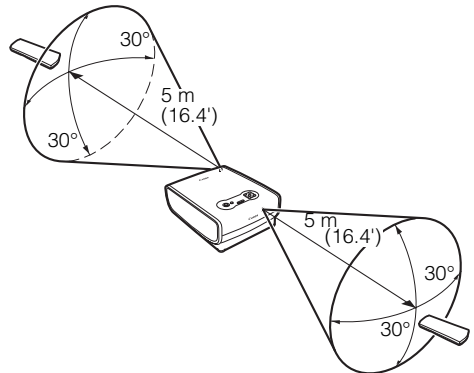

The remote control may be inoperative if:

- There is an obstacle between the remote control and main unit.
- The infrared remote receiver on the main unit is exposed to direct sunlight or strong light of lighting equipment.



- The remote control uses infrared light.
- When you use two projectors at the same time, you can change the channel settings to prevent the two remote controls from interfering with each other (P100).

# SETTING UP THE PROJECTOR

Safety Instructions

Before Use

Setting Up the Projector

Projecting an Image from the Computer

Projecting an Image from AV Equipment

Useful Functions Available During a Presentation

Setting Up Functions from Menus

Maintenance

Troubleshooting

Appendix

Index

# Setting Up the Projector

## Determining the Distance to the Screen

The projected image size is determined by the distance between the projector lens and the screen. Select the place where the desired image size is obtained according to the illustration shown below.

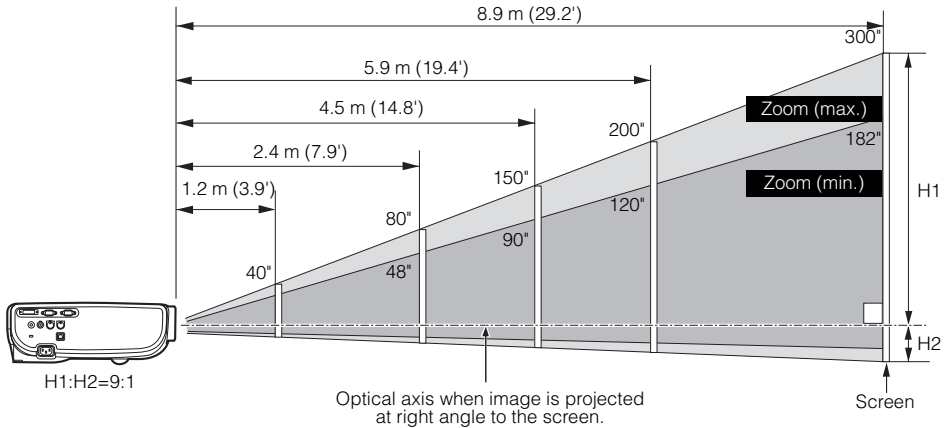

Screen size (W x H) cm	40"	60"	80"	100"	150"	182"	200"	250"	300"	
	81 x 61	122 x 91	163 x 122	203 x 152	305 x 229	370 x 277	406 x 305	508 x 381	610 x 457	
Projection distance	Zoom (max)	1.2 m (3.9')	1.8 m (5.9')	2.4 m (7.9')	3.0 m (9.8')	4.5 m (14.8')	5.4 m (17.7')	5.9 m (19.4')	7.4 m (24.2')	8.9 m (29.2')
	Zoom (min)	2.0 m (6.6')	2.9 m (9.6')	3.9 m (12.9')	4.9 m (16.1')	7.4 m (24.2')	9.0 m (29.5')	-	-	-
H1	55 cm (1.8')	82 cm (2.7')	110 cm (3.6')	137 cm (4.5')	206 cm (6.8')	250 cm (8.2')	274 cm (9.0')	343 cm (11.3')	411 cm (13.5')	
H2	6 cm (0.2')	9 cm (0.3')	12 cm (0.4')	15 cm (0.5')	23 cm (0.8')	28 cm (0.9')	30 cm (1.0')	38 cm (1.2')	46 cm (1.5')	

H1 and H2: The height of the screen from the intersection of optical axis and screen surface when an image is projected at right angle to the screen.

- Install the projector at the position where the projection distance is between approximately 1.2 m (3.9') to 9 m (29.5'). If the installation position is too close or too far, the image is out of focus or the screen becomes dark, respectively.
- The sizes in the above table have been obtained assuming that the aspect ratio is 4:3. They may vary from the actual sizes depending on the type of the projected image.



- For the relationship between the screen size and projection distance, see the table on page 119.
- You can also adjust the image size with the zoom function (P37).

## Determining the Installation Position

### Placing in Front of the Screen

Place the projector perpendicular to the screen as far as possible.



- A slight error in the projection angle can be corrected using the [KEYSTONE] button (P47).

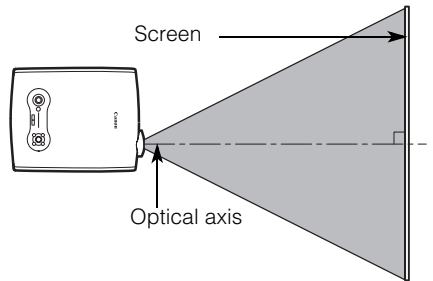

### Placing on a Level Place

Place the projector on a level place as far as possible.



- A slight tilt can be corrected using the rear adjustable foot. (P38)
- Make sure that the installation position is free from any obstacle that may block the exhaust vent (fan) on the right side of the projector and the air intake vent on the bottom of the projector.
- The screen must not be exposed to direct sunlight or light from lighting equipment. In a bright room, it is recommended to limit ambient lighting in order to improve the image quality.

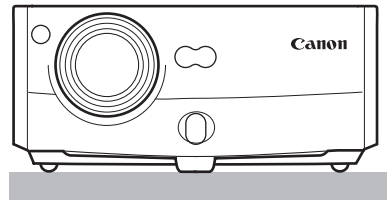

### Ceiling Mounting or Rear Projection

You can mount the projector on the ceiling (Ceiling mounted) with it turned up side down or place it behind the screen (Rear) if you use a translucent screen.

If you mount the projector on the ceiling, you have to invert the projected image (P85).

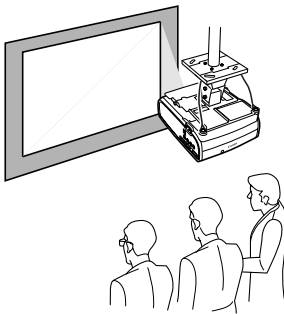

Ceiling Mounting

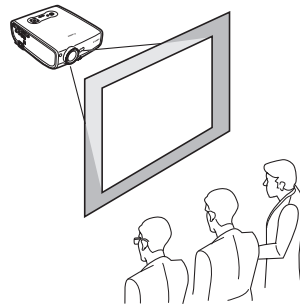

Rear Projection



# PROJECTING AN IMAGE FROM THE COMPUTER

Safety Instructions

Before Use

Setting Up the Projector

Projecting an Image from the Computer

Projecting an Image from AV Equipment

Useful Functions Available During a Presentation

Setting Up Functions from Menus

Maintenance

Troubleshooting

Appendix

Index

# Projecting an Image from the Computer

## Connecting the Projector to the Computer

Connect the projector to the computer.

### Connecting to Video Terminals

#### Supplied computer connection cable

To monitor output terminal  
(mini D-sub 15-pin terminal)

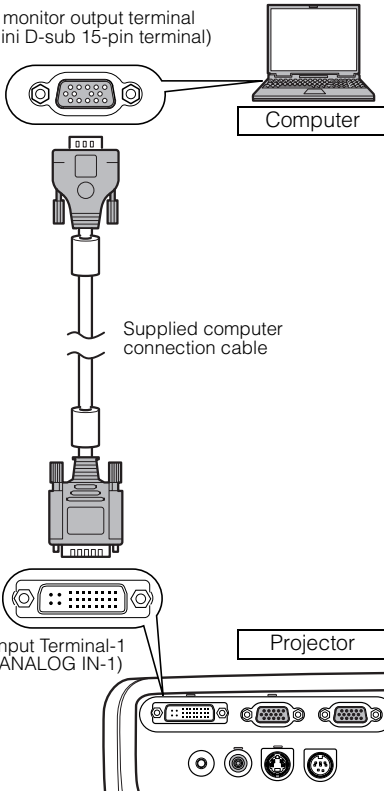

Input Signal: Select [ANALOG PC-1] (P43)

#### VGA cable

To monitor output terminal  
(mini D-sub 15-pin terminal)

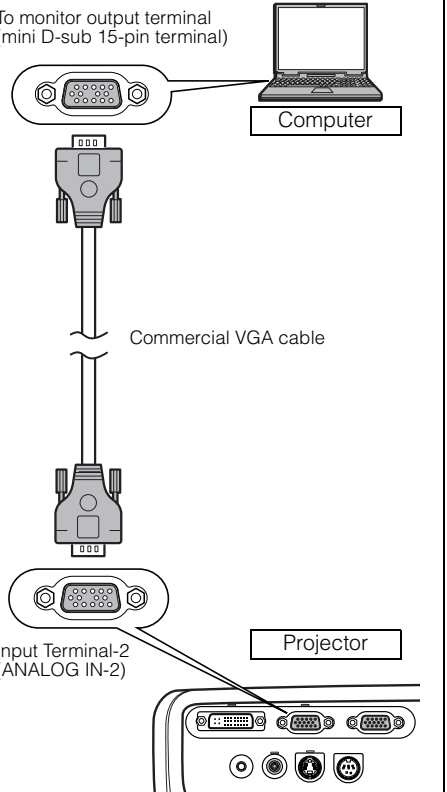

Input Signal: Select [ANALOG PC-2] (P45)



- To ensure projection of high-resolution high-quality images, it is recommended to use high-performance cables.
- An adapter may be required depending on the shape of the connector on the computer. For more detailed information, refer to your computers instruction manual.



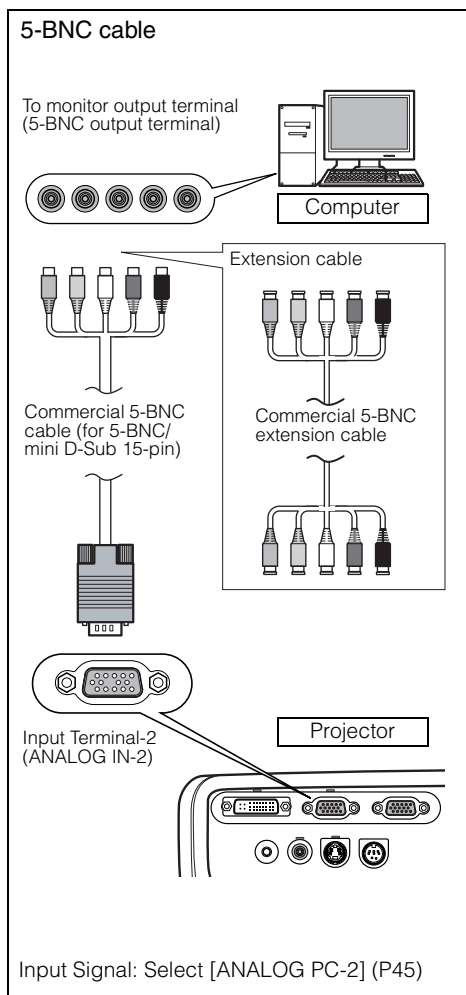
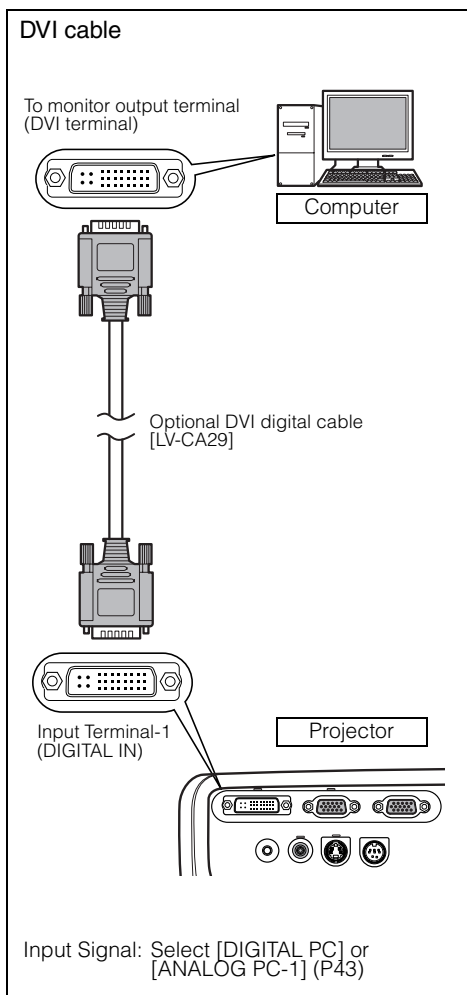

- Before connecting cables, turn off both the projector and computer.
- It may project an image inappropriately when projecting the digital PC signal in 1280 x 1024 or 1400 x 1050 depending on the type of computer or DVI cable (SX6/SX60).
- The USB terminal is used to use the remote control as the computer mouse. An image cannot be projected simply by connecting the USB cable.

## Connecting to an External Monitor

You can display an image from the projector to an external monitor.

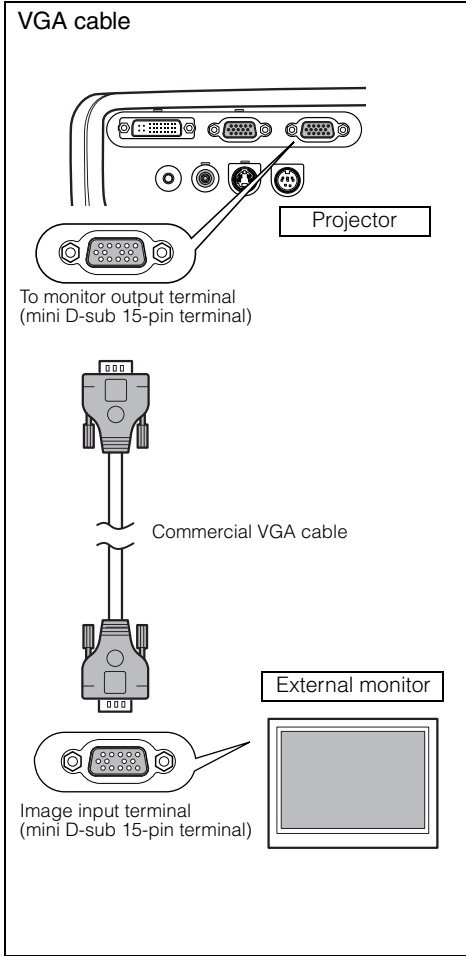

## Connecting to Audio Terminals

Connect an audio cable between the projector and computer if you want to use the projectors speaker.

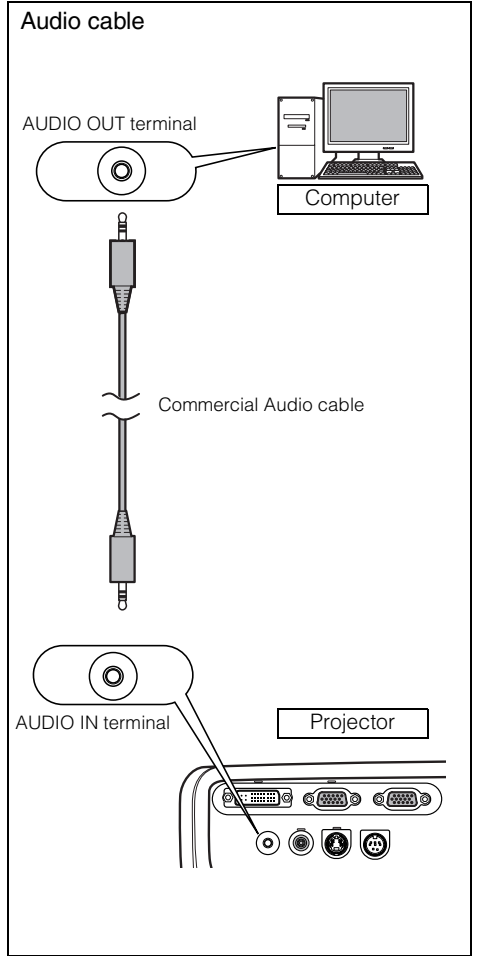

- You can connect one external monitor. The multi-monitor display is not supported.
- The projected image is displayed on the external monitor.
- You cannot output the input signal to the external monitor if it is DIGITAL PC.



- Use an audio cable without a built-in resistor. Using an audio cable with a built-in resistor turns down the sound.
- The built-in speaker is monaural.
- The speaker plays the sound from the equipment which the audio cable is connected to regardless of the image input signal.

# Starting Projection

Connect the power cord and turn on the projector to start the projection.

- Once the projector is turned off, it cannot be turned on for a while. Wait until the lamp is cooled down and the [POWER] indicator lights in red.

## 1 Connect the power cord.

Fully insert the power cord plug into the socket.  
The [POWER] indicator flashes red.

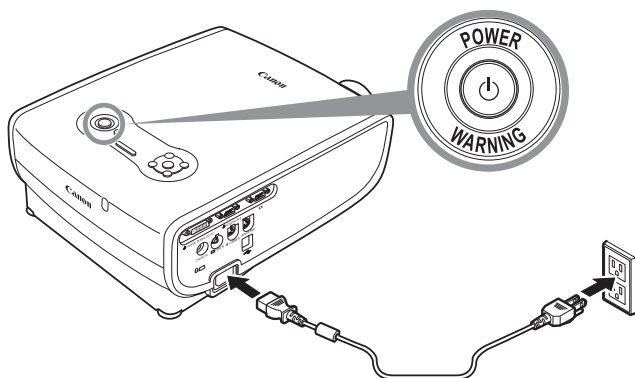

## 2 Press the [POWER] button.

The [POWER] indicator flashes green, and then lights in green.

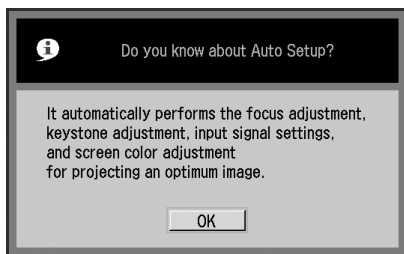
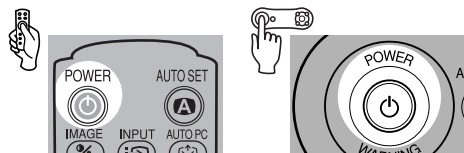

The countdown window is displayed for approximately 20 seconds, and then the guiding message for the auto setup function appears.

The LED illumination lamp blinks blue until the projection is started.  
To project an image immediately, press the [OK] button.

- Enter a password if the Password input screen appears (P101, 102).
- You can turn on the projector by connecting the power cord without pressing the [POWER] button (direct power on) (P97).
- You can display a specified Logo on the countdown screen (P88).
- You can specify whether to enable or disable the LED illumination lamp (P100).
- You can skip the countdown window (P88).



## Connect the Ground Terminal

Connect the ground terminal on the power plug to ground. Otherwise, the operating computer may suffer electromagnetic radiation problems and poor reception by TV and radio.

## Unplug the Power Cord When the Projector is Not in Use

The projector constantly consumes approximately 7W power even when it is turned off. To ensure safety, malfunction prevention, and power saving, remove the power plug from the AC outlet when the projector is not used for an extended period of time.

## Selecting a Language

A window appears when the projector is turned on for the first time. You can select a language to be used by the projector for displaying menus and so on in the window. Select your language as shown below.

Select a language with the POINTER buttons and press the [OK] button.

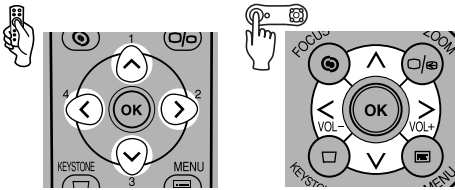

An item highlighted in orange will be selected.

- Focus the projected image before selecting the language if it is out of focus (P46).
- You can change the language from the menu at a later time (P98).

# Adjusting the Image

## Adjusting the Image Size (ZOOM).

Adjust the image size in accordance with the screen.

### 1 Press the [ZOOM] button.

The Zoom adjustment window appears.

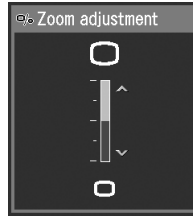
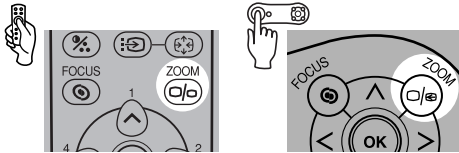

### 2 Adjust the image size.

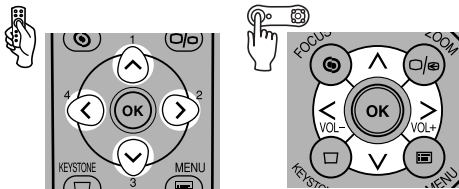

#### Zoom in:

Press [ $\wedge$ ] for rough adjustment.  
Press [ $>$ ] for fine adjustment.

#### Zoom out:

Press [ $\vee$ ] for rough adjustment.  
Press [ $<$ ] for fine adjustment.

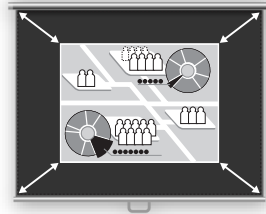

### 3 Press the [OK] button.

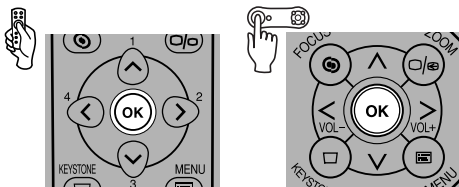

- Change the projector installation position if your desired image size is too large or too small to adjust with the zoom function (P28).

## Adjusting the Projection Angle

You can adjust the projection angle with the adjustable foot.

- 1** Lift the front side of the projector and push the adjusting foot lock button. The adjustable foot extends.
- 2** Adjust the projection angle while pushing the adjustable foot lock button, and then release the lock button. The adjustable feet is fixed.

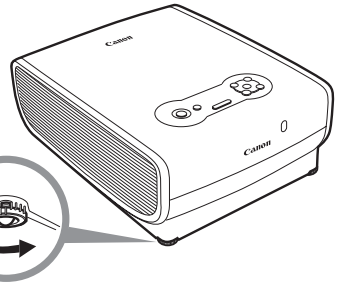
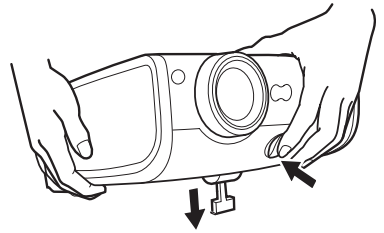

- With the adjustable foot, the projection angle can be adjusted up to 10 degrees.
- If the projector is tilting in the lateral direction, use the rear adjustable feet on both sides to adjust its angle. You can adjust up to 10mm with one foot.

## If Keystone Distortion is Too Large

Extending the adjustable foot too far causes keystone distortion. If the distortion is too large, adjust the height of the projector with a pedestal.

The keystone distortion can be corrected with the Auto keystone function or by pressing the [KEYSTONE] button. (P41, 47, 60)

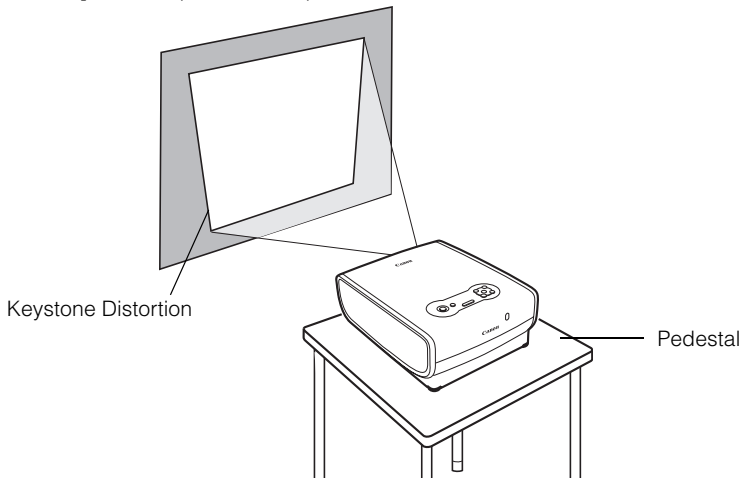

# Preparing the Computer

## Determining the Output Resolution of the Computer

To make the most of the display performance of this projector, set output signal resolution of the computer to an optimum value.

### Windows XP

1. Right-click on the desktop background and select [Properties] to open the [Display Properties].
2. Select the [Settings] tab and move the slider to select "1400 x 1050 pixels" ("1024 x 768 pixels" for X600). If this resolution is not available, select the highest resolution under 1400 x 1050 pixels. (under 1024 x 768 pixels for X600)
3. Click the [OK] button.



### Macintosh OSX

1. Open the Apple Menu and select [System Environment Setting].
2. In the System Environment Setting window, click the [Displays] icon to display the Display window.
3. Select the [Display] tab and select "1400 x 1050" ("1024 x 768" for X600) from the [Resolution] list. If this setting is not available, select the highest resolution under 1400 x 1050. ("1024 x 768 pixels" or less for X600)
4. Close the windows.

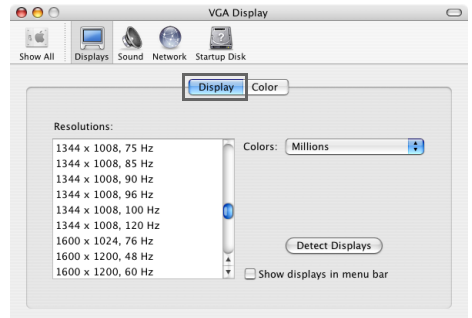

### For SX6/SX60

- If the display resolution of the computer is set to SXGA (1280 by 1024 dots) or WXGA (1280 by 768 dots), it is recommended to select [True size] as the screen mode (P78).

## Projecting the Image from the Notebook Computer

Most of notebook computers require to turn on the external monitor output to project an image from the projector. To turn on the external monitor output, press the [LCD] or [VGA] function key ([F1] to [F10]) or a key with an icon for the external monitor while pressing the [Fn] key on the keyboard.

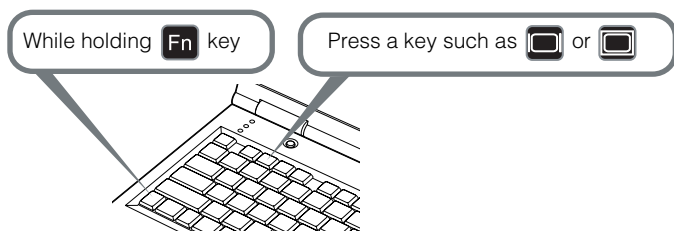

The following table lists the key combinations for each personal computer manufacturer.

DELL	[Fn]+[F8]
EPSON	[Fn]+[F8]
FUJITSU	[Fn]+[F10]
GATEWAY	[Fn]+[F3]
HITACHI	[Fn]+[F7]
HP	[Fn]+[F4]
IBM	[Fn]+[F7]

MITSUBISHI	[Fn]+[F5]
NEC	[Fn]+[F3]
Panasonic	[Fn]+[F3]
SHARP	[Fn]+[F5]
SONY	[Fn]+[F7]
SOTEC	[Fn]+[F3]
TOSHIBA	[Fn]+[F5]



- For the key combination for the computer series not listed in the above table, refer to the User's Manual that came with the computer.



## Performing the Auto Setup

With the auto setup function, the following set of adjustments is performed automatically when projecting an image from a computer. You can start the projection only with this operation if the input signal has been appropriately selected.

### Auto focus

Adjusts the focusing automatically.

### Auto keystone

Corrects the keystone distortion (in the vertical direction) automatically.

### Auto input

Sets the image input signal automatically.

### Auto screen color\*

Performs the screen color correction (white balance adjustment) automatically.

\*: This is not enabled at the factory.



- Among 4 functions above, the function that has been enabled in the menu is performed during the auto setup. "Auto focus", "Auto keystone", and "Auto input" are enabled in the factory.
- You can manually set or adjust each function. You can set or adjust a specific function independently if you press the [AUTO SET] button during the manual adjustment.
- Select [Greenboard] from [Screen color] when using a greenboard (dark green) as a screen (P86).
- The auto focusing and the screen color correction may not be performed properly depending on the brightness of the room or the condition of the screen. Adjust the image manually if such is the case.

## 1 Select an input signal.

Select an appropriate input signal by following the steps in the "Selecting an Input Signal" section at the page 43 if you change the input signal due to changing the connection to the computer or so.

Skip this step if you have not changed the input signal since the last projection.

## 2 Press the [AUTO SET] button.

The Auto setup window appears.

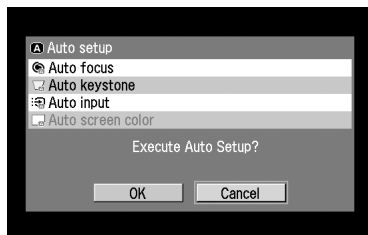
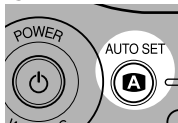
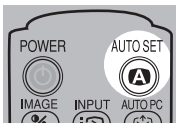

---

### 3 Press the [AUTO SET] button again.

One or more functions highlighted in black are performed automatically.

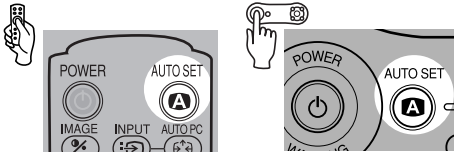

- You can perform this step by selecting [OK] with the [<] button, and then pressing the [OK] button.

## Selecting an Input Signal

You can select an input signal type.

Select an input signal from the followings:

ANALOG PC-1 : Analog signal Connecting with a DVI/Mini D-sub 15-pin cable  
(supplied cable)

DIGITAL PC : Digital signal Connecting with a DVI digital cable

ANALOG PC-2 : Analog signal Connecting with a VGA cable or 5-BNC cable

Select an appropriate input signal before starting the auto setup function by following the steps below if you change the input signal due to changing the connection to the computer or so.



- An LED for a terminal flashes in green if a cable is connected and an input signal is confirmed. An LED for a terminal turns on if the projected image is obtained through the terminal.
- Connecting a DVI cable to Input Terminal-1, select the appropriate input signal with the [INPUT] button in accordance with the setting on the computer (digital signal/analog signal).

### ■ Selecting [ANALOG PC-1] or [DIGITAL PC]

#### 1 Press the [INPUT] button.

The [INPUT] window appears.

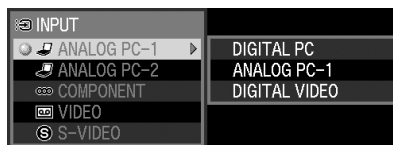
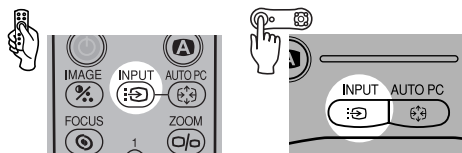

#### 2 Select the top item in the menu with the [INPUT] button.

The selection is toggled through available input signal types from above.

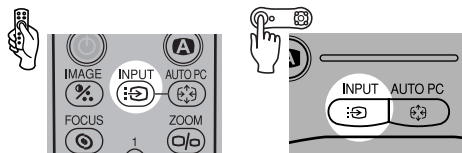

- You can select any input signal type from all options through the [V] / [Λ] button.

- 
- 3 If the target input signal is unavailable from the list at the left, press the [>] button, and then press the [v] / [^] button to select the target input signal from the list at the right.

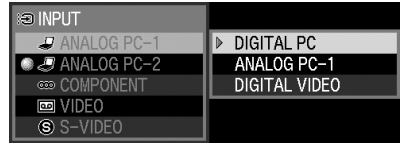
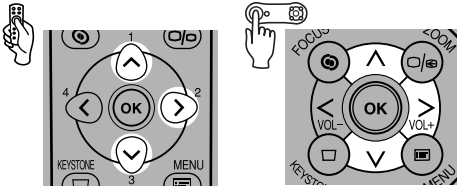

- 4 Press the [OK] button.

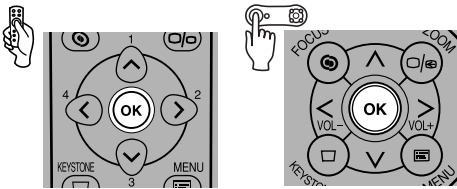

## ■ Selecting ANALOG PC-2



- Select [ANALOG PC-2] for Input Terminal-2.

### 1 Press the [INPUT] button.

The [INPUT] window appears.

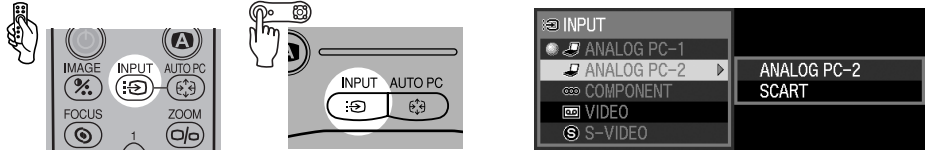

### 2 Select the second top item in the menu with the [INPUT] button.

The selection is toggled through available input signals from above.

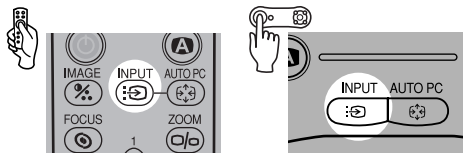

- You can select any input signal type from all options through the [V] / [Λ] button.

### 3 If the ANALOG PC-2 is unavailable from the list at the left, press [>], and then press [V] / [Λ] to select the ANALOG PC-2 from the list at the right.

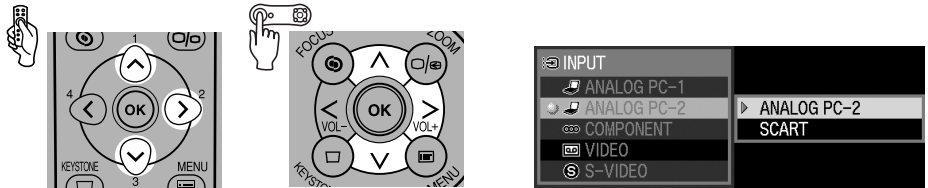

### 4 Press the [OK] button.

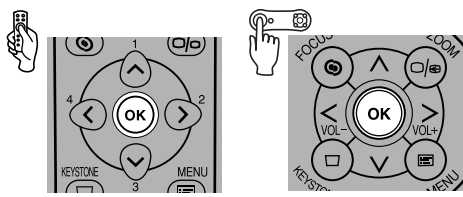

# Adjusting the Focus

You can adjust the focus.

Follow the steps below to adjust the focus manually if the Auto setup function (Auto focus) does not adjust the focus appropriately.

## 1 Press the [FOCUS] button.

The Focus adjustment window appears.

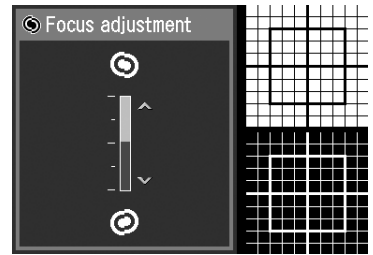
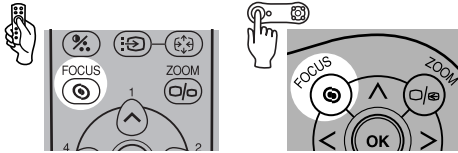

## 2 Press the POINTER buttons to adjust the focus.

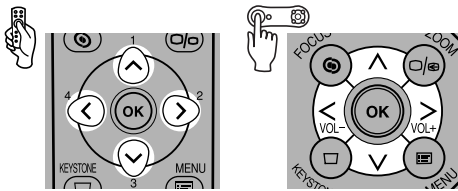

Rough adjustment: [v] [^]  
Fine adjustment : [<] [>]



- You can activate the Auto focus function if you press the [AUTO SET] button now.



- The projected image may be out of focus if the projection distance is beyond the range of 1.2 m (3.9') to 9 m (29.5'). Move the projector installation position if such is the case (P28).

# Adjusting Keystone Distortion

The Auto setup function (Auto keystone) automatically adjusts the keystone distortion in a longitudinal direction. Follow the steps below if the function does not adjust the distortion appropriately or you want to adjust the keystone distortion in a horizontal direction.

## 1 Press the [KEYSTONE] button.

The [Keystone adjustment] windows appears.

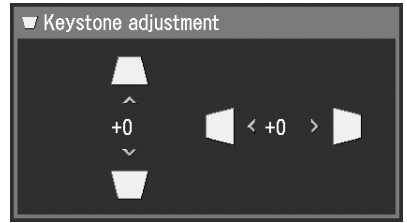
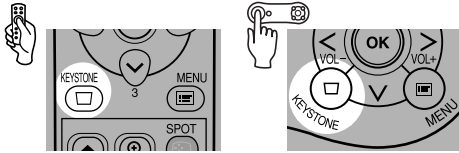

## 2 Press the POINTER buttons to adjust the focus.

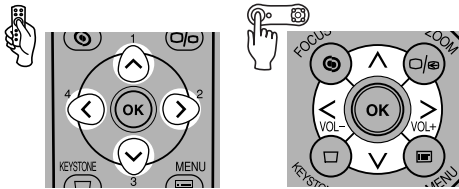

To reduce the length of the upper edge, press [ $\wedge$ ].

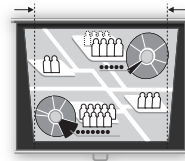

To reduce the length of the lower edge, press [ $\vee$ ].

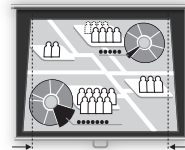

To reduce the length of the left edge, press [ $\leftarrow$ ].

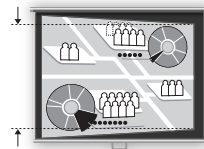

To reduce the length of the right edge, press [ $\rightarrow$ ].

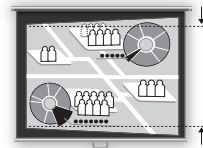

- You can activate the Auto keystone function if you press the [AUTO SET] button now.

---

### 3 Press the [OK] button.

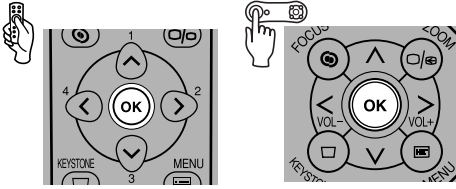

- The result of keystone adjustment is memorized. If you place the projector at the same position, the keystone adjustment is not necessary.
- When the Keystone adjustment is selected, signals are processed digitally. The image may look different from the original one.
- The aspect ratio of the image may change after the keystone adjustment.
- Keystone can be adjusted vertically and horizontally within the range of +/-20 degrees. The amount of adjustment may be less than +/-20 degrees depending on the combination of the amount of optical zooming, input signal type, and adjustment direction (vertical or horizontal).
- If the keystone distortion is too large to adjust, move the projector installation position.
- To reset the keystone adjustment to 0, press the [KEystone] button again to display the [Keystone reset] window. On the window, select [OK] with the [<] button, and then press the [OK] button.



## Setting Up the Computer Screen Automatically (AUTO PC)

This projector automatically makes optimum settings for the total number of dots and tracking depending on a signal type (SXGA+, XGA, etc.).

The auto PC adjustment function does not need to be performed if the projector is projecting an image properly with [AUTO SETUP].

You can use this function if the input signal is [ANALOG PC-1] or [ANALOG PC-2].

### 1 Press the [AUTO PC] button.

The auto PC adjustment function is activated and the projected image is optimized.

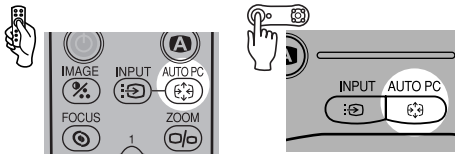

- For some computers, the auto PC adjustment function does not optimize the projected image. If such is the case, you need to make settings (total dots, tracking, horizontal/vertical positions, horizontal/vertical pixels, etc.) for the input signal (P81-83).



- The previous signal type ([ANALOG PC-1] or [ANALOG PC-2]) is recorded. If you connect the projector to the same computer, you can project the image with the same settings as before simply by selecting the input signal.

## Selecting an Image Mode (IMAGE)

You can select an image mode depending on the projecting image. You can also adjust the image quality (sharpness, gamma, color correction, etc.) as you like.

- 1 Press the [IMAGE] button.

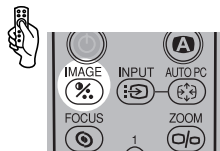

(SX6)

The Image mode window appears. The selection is toggled among following modes by pressing the button.

**[Standard]** Select this to project an image with near-original quality and a high regard for reproduction of white. It is also suited to project moving pictures such as a TV program or a DVD movie in a bright room.

**[Presentation]** Select this to project an image with quality suited for the presentation. It also suited to project moving pictures with a high regard for the brightness.

**[Movie]** Select this to project moving pictures of all kinds. Its brightness is suited to easily enjoy the atmosphere of a movie theater in a dim room.

**[Movie&Photo]** Select this to project an image or moving pictures with quality suited for those shot by a digital camera or so.

**[sRGB]** Select this if you want to project an image in the display mode conforming to Windows standard color space. It is suited to project an image shot by an sRGB-compatible digital camera.

**[AdobeRGB]** Select this if you want to project an image in the display mode conforming to Adobe RGB color space. You can project an image with more accurate color reproduction since It has wider color gamut than sRGB.

**[Home Cinema]** Select this to project a movie with quality suited to seriously enjoy the atmosphere of a movie theater in a dark room.

SX6	SX60	X600
Standard Presentation Movie&Photo AdobeRGB sRGB	Standard Presentation Movie Home Cinema sRGB	Standard Presentation Movie sRGB



- You can adjust the followings for each image mode. For detailed information on the procedures, refer to "Image Adjustment Menu" (P89 to 95).
  - Brightness Adjust this when the image is too bright or dark.
  - Contrast Adjust this to decrease or increase contrast of the entire image.
  - Sharpness Adjust this to soften or sharpen an image.
  - Gamma Adjust this when light or dark portions of an image are obscure.
  - Color adjustment  
Adjust this to adjust the color level and balance.
  - Advanced adjustment  
Adjust this when color tones are different from those of the original image.
- The results of adjustments are saved for each input signal. Once you save them, you can project images with the same settings.
- You can set an image mode from the menu. Refer to [Image mode] section in the menu (P89)

---

## Selecting a Screen Mode (Aspect)

---

You can select one of four screen modes depending on the aspect ratio or display resolution of your computer.

- You can specify the aspect ratio from the menu. Refer to [Aspect] in the menu (P78).

### ■ Full screen

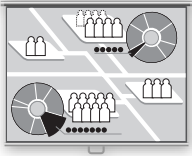

Select this to project a computer screen with aspect ratio of 4:3 (SXGA+ [1400 by 1050 dots] or XGA [1024 by 768 dots]).

If you select this mode to project the computer screen with aspect ratio of 5:4 (SXGA [1280 by 1024 dots]), it is compressed vertically or horizontally.

Select this mode under normal conditions.

### ■ Auto

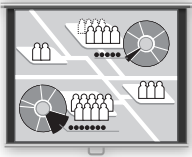

Select this to project a wide screen or computer screen with aspect ratio of 5:4 (SXGA).

Since the image is projected with it fitted to either the width or length of the computer screen, it does not display the top and bottom portions or the leftmost and rightmost portions of the image.

### ■ Wide Screen

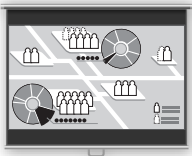

Select this to project a computer screen with aspect ratio of 16:9.

Since the image is projected with it fitted to the width of the computer screen, it blackens the top and bottom portions of the screen.

### ■ True size



Select this if you want to project a computer screen in its original size.

A clear image can be obtained because of no image processing.



- If the display resolution of the computer is higher than 1400 by 1050 dots (1024 by 768 dots for X600), select a lower resolution before starting projection.
- The upper, lower, left, and/or right portions of a projected image may be missing depending on the Aspect setting.

# Turning Off the Projector



- You may shorten the lamp life if turning off the projector while its lamp is still in an unstable state shortly after turning on the projector. Wait at least 5 minutes before turning off the projector.
- Wait at least 5 minutes before turning on the projector when you turn off the projector. It may shorten the lamp life if you turn on the projector immediately after turning it off.
- Using the projector for a long time may shorten the life of the lamp and internal optical components.



- When the projector is turned off, it starts cooling the lamp. You cannot turn it on during the process.

## 1 Press the [POWER] button.

A confirmation message appears on the screen.

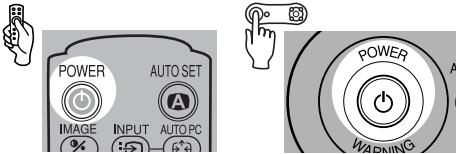

To continue projection, wait until the confirmation message disappears (approximately 4 seconds) or press a button other than the [POWER] button.

## 2 Press the [POWER] button again while the confirmation message is displayed.

The lamp goes off, the [POWER] indicator starts flashing in red, and it starts cooling the lamp.

## 3 Remove the power cord from the AC outlet.

It continues to cool down the lamp even after removing the power cord.

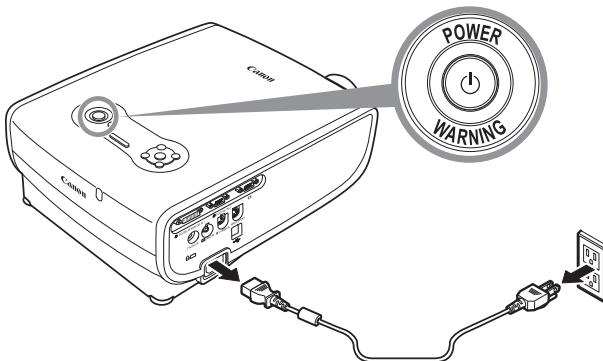



- You can carry the projector immediately after the use ("Off & Go" function).
- You can turn off the projector by disconnecting the power cord without pressing the [POWER] button (direct power on). (P97)
- The LED illumination lamp turns on to indicate the lamp is being cooled when the power cord is connected.

## Setting Up the Power Management Function

You can use the power management function that turns off the lamp if the projector receives no signal input for a while.

If you enable the power management mode, the projector displays a countdown timer if the projector is receiving no signal input and is not operated for 30 seconds, and approximately 5 minutes later the lamp is turned off and the projector goes into the power management mode.

You can select one of the following power management modes from the menu (P96).

### Standby mode

Select this mode if you want to start projection soon.

In the standby mode, the lamp is turned off and cooled down. When the lamp has been cooled down, the [POWER] indicator starts flashing in red and green to indicate it is standby. It will start projection if the input signal is inputted or any button on the top control or remote control is pressed.

### Exit mode

Select this mode to turn off the projector automatically.

In the exit mode, the lamp is turned off and cooled down. When the lamp has been cooled down, the [POWER] indicator stops flashing in red and stays on and the power is turned off.



- The projector becomes inoperative when the lamp is being cooled in a power management mode.

# PROJECTING AN IMAGE FROM AV EQUIPMENT

Safety Instructions

Before Use

Setting Up the Projector

Projecting an Image from the Computer

Projecting an Image from AV Equipment

Useful Functions Available During a Presentation

Setting Up Functions from Menus

Maintenance

Troubleshooting

Appendix

Index

# Projecting an Image from AV Equipment

## Connecting the Projector to an AV Equipment

Connect the projector and AV equipment.

### Connecting to Video Terminals

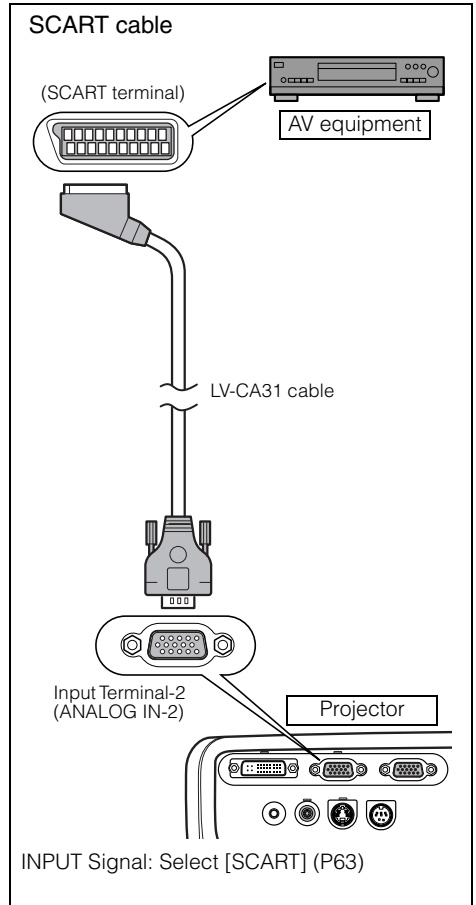
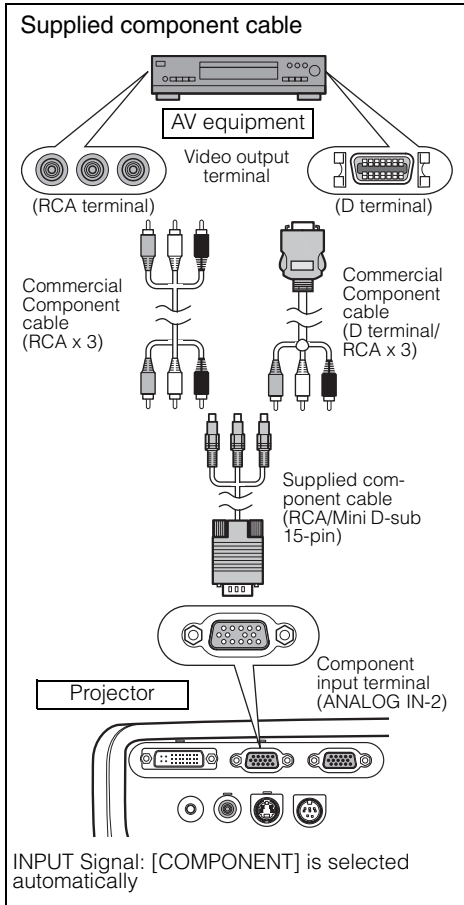

- Before connecting cables, turn off both the projector and AV equipment.
- The above illustrations are just examples. For more detailed information, refer to the manual for the connecting AV equipment.



#### About the Component Cable

The projector cannot be connected to an AV equipment only with the supplied component cable (RCA/Mini D-sub 15-pin). Please purchase either of the following cables according to the type of the terminal on the AV equipment:

- RCA terminal: RCA x 3/RCA x 3 cable
- D-terminal: D-terminal/ RCA x 3 cable



### Digital cable

You can project digital content via the HDMI or DVI terminal.

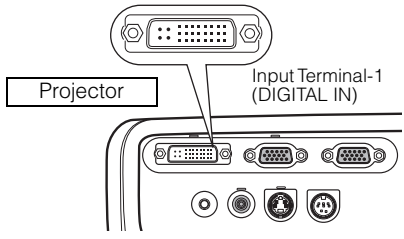
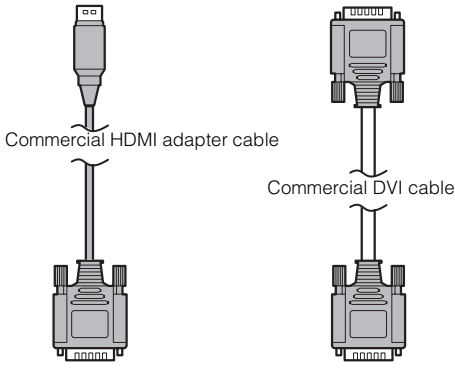
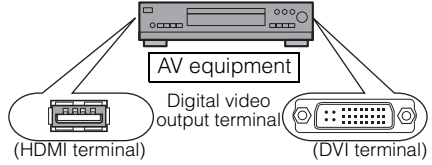

INPUT Signal: Select [DIGITAL VIDEO] (P61)

### S-VIDEO cable

S-VIDEO output terminal (S-VIDEO OUT terminal)

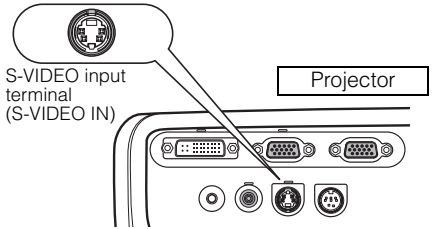
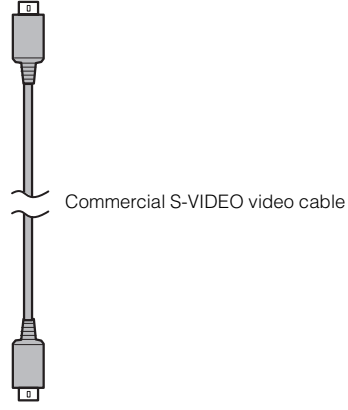

INPUT Signal: [S-VIDEO] is selected automatically



- Connect an audio cable if you want to use the projector's speaker (P34).
- Set the input signal as [COMPONENT] by referring to "Projecting an Image from the Computer" and "5-BNC cable" if you want to connect the projector to an AV equipment using a 5-BNC extension cable via an video control apparatus in a hall or so (P33).

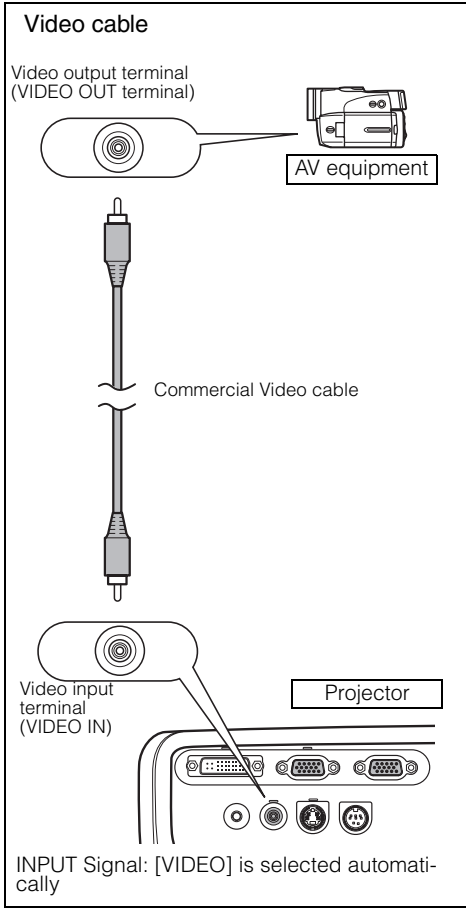

---

## Projecting a Video Image from an AV Equipment

---

You can project a video image with the steps similar to those for projecting an image from a computer.

This section provides information specific to the projection from an AV equipment.

For more detailed information for each step, refer to the corresponding page.

### 1 Turn on the projector. P35\*

- Connect the power cord and turn on the projector (P35).
- Adjust the height of the projecting image (P38).
- Select a display language for the first time (P36).



### 2 Prepare the AV equipment.

- Turn on the AV equipment and start playing the video image.



For digital content video image:

### 3 Press the button to switch the input signal. P61

- Select [DIGITAL VIDEO] as the input signal.





### 4 Press the button. P60

- Adjust the input signal, focusing, keystone distortion, and so on automatically using the auto setup function.



### 5 Press the button.

- Select an appropriate image mode depending on the projecting image.  P50\*
- Select an appropriate screen mode from the [Aspect] menu.  P64, 78, 79



Stopping projection...

### Turn off the projector. P53\*

- Turn off the projector and remove the power cord from the AC outlet.

\* Those steps are same as those for projecting the computer screen.

## Performing the Auto Setup

With the auto setup function, the following set of adjustments is performed automatically when projecting a video image from an AV equipment. You can start the projection only with this operation if the input signal has been appropriately selected.

### Auto focus

Adjusts the focusing automatically.

### Auto keystone

Corrects the keystone distortion automatically.

### Auto input

Sets the image input signal automatically.

### Auto screen color\*

Performs the screen color correction (white balance adjustment) automatically.

\*: This is not enabled at the factory.



- Among 4 functions above, the function that has been enabled in the menu is performed during the auto setup. "Auto focus", "Auto keystone", and "Auto input" are enabled in the factory.
- You can manually set or adjust each function. You can set or adjust a specific function independently if you press the [AUTO SET] button during the manual adjustment.
- Select [Greenboard] from [Screen color] when using a greenboard (dark green) as a screen (P86).
- The auto focusing and the screen color correction may not be performed properly depending on the brightness of the room or the condition of the screen. Adjust the image manually if such is the case.

## 1 Select [DIGITAL VIDEO].

Perform the steps shown in the "Selecting DIGITAL VIDEO" section on page 61 before performing the auto setup if you want to project a digital content video image. Skip this step if [DIGITAL VIDEO] has been selected at the previous projection.

## 2 Press the [AUTO SET] button.

The [Auto setup] window appears.

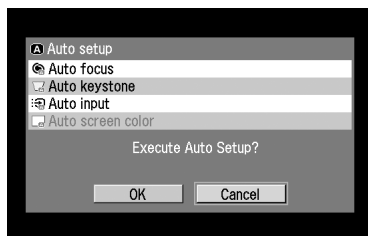
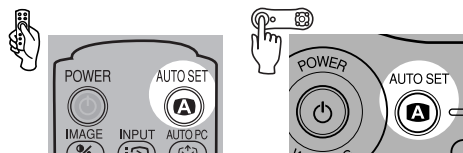

### 3 Press the [AUTO SET] button again.

One or more functions highlighted in black are performed automatically.



- You can perform this step by selecting [OK] with the [<] button, and then pressing the [OK] button.

## Selecting an Input Signal

Select [DIGITAL VIDEO] among the following 4 input signals by following the steps shown in the "Selecting DIGITAL VIDEO" section below if you want to project a digital content video image.

DIGITAL VIDEO	: Digital signal	Connecting with an HDMI/DVI cable or DVI digital cable
COMPONENT	: Component signal	Connecting with a supplied component cable
SCART	: SCART signal	Connecting with a supplied SCART cable
VIDEO	: Video signal	Connecting with a video cable
S-VIDEO	: S-VIDEO	Connecting with an S-Video cable

The component, video, and S-VIDEO signals are automatically set if a cable is connected and the input signal is confirmed.



- A LED (green) on a terminal flashes when an input signal is confirmed. The LED turns on if the signal is selected and projected.
- Connecting with a HDMI/DVI cable, the image may be projected with the minimum resolution (480p or 575p) due to the specification of the AV equipment.

### ■ Selecting DIGITAL VIDEO

#### 1 Press the [INPUT] button.

The [INPUT] window appears.

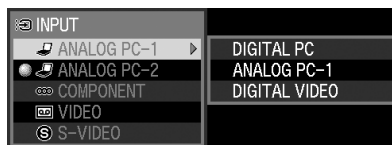
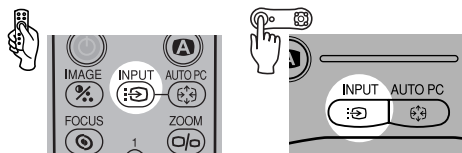

---

## 2 Select the top item in the menu with the [INPUT] button.

The selection is toggled through available input signal types from above.

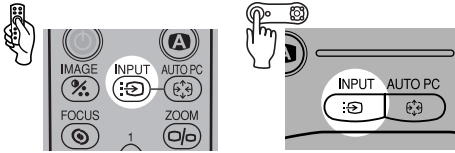

- You can select any input signal type from all options through the [v] / [^] button.

---

## 3 If [DIGITAL VIDEO] is unavailable from the list at the left, press [>], and then press [v] / [^] to select it from the list at the right.

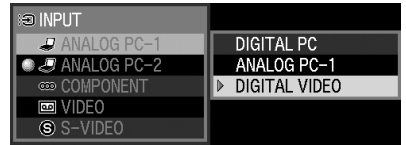
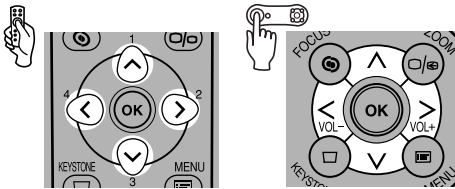

---

## 4 Press the [OK] button.

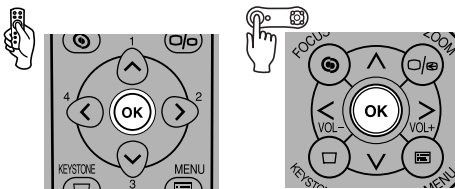

## ■ Selecting SCART



- Select [SCART] for Input Terminal-2.

### 1 Press the [INPUT] button.

The [INPUT] window appears.

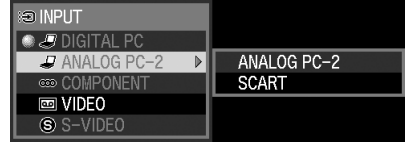
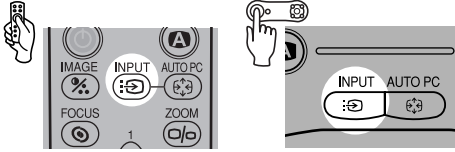

### 2 Select the second top item in the menu with the [INPUT] button.

The selection is toggled through available input signals from above.

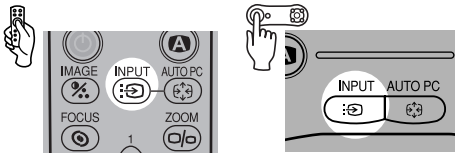

- You can select any input signal type from all options through the [v] / [^] button.

### 3 If the SCART is unavailable from the list at the left, press [>], and then press [v] / [^] to select the SCART from the list at the right.

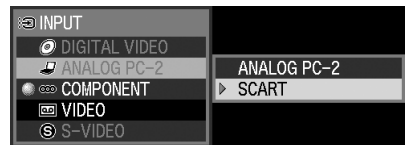
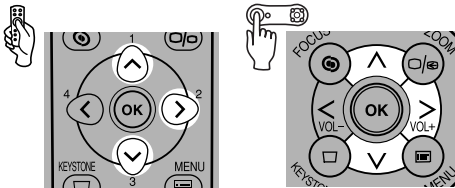

### 4 Press the [OK] button.

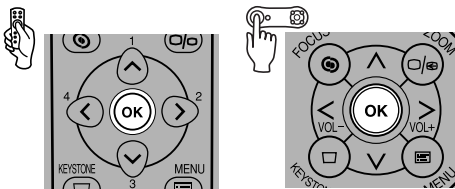

---

## Selecting a Screen Mode (Aspect)

---

You can select one of three screen modes depending on the aspect ratio of your AV equipment or content software.

- You can specify the aspect ratio from the menu. Refer to [Aspect] in the menu (P78, 79).

### ■ Full screen

Select this to project a video image with aspect ratio of 4:3. 4:3



### ■ Wide Screen

Select this to project a video image with aspect ratio of 16:9. 16:9



- Refer to the table on the page 119 for more detailed information on the screen size for the wide screen.



### ■ Auto ([DIGITAL VIDEO]/[COMPONENT])

Select this to switch between [Normal] and [Wide Screen] automatically in accordance with the video image.



- The upper, lower, left and right portions of a projected image may be missing depending on the [Aspect] setting.



# USEFUL FUNCTIONS AVAILABLE DURING A PRESENTATION

Safety Instructions

Before Use

Setting Up the Projector

Projecting an Image from the Computer

Projecting an Image from AV Equipment

Useful Functions Available During a Presentation

Setting Up Functions from Menus

Maintenance

Troubleshooting

Appendix

Index

# Useful Functions Available During a Presentation

## Blackened Out an Image Temporarily

NO SHOW



- ▶ Useful when:
- ▶ You finished the presentation.
- ▶ You want to divert attendees' attention from the screen.

Blacken out the image temporarily.

### Blackening out an Image



The screen changes to black or blue.

### Showing the Image Again

Press the <sup>NO SHOW</sup> button to show the image again.



- You can capture a specified logo (P86).
- You can show a logo such as a company logo while blackening out the image (P88).
- The (middle) LED illumination lamp on the top control flush slowly while blackening out the image.
- A guiding message appears if you press an invalid button while the NO SHOW function is on.



## Muting the Sound

MUTE



- ▶ Useful when:
- ▶ You want to immediately mute the sound from the projector.

Mute the sound temporarily.

### Muting the Sound



The projector shows the [MUTE] icon on the screen.

### Canceling the MUTE function

Press the <sup>MUTE</sup> button again to cancel the MUTE function.

Pressing the <sup>VOL</sup> button also cancels the MUTE function.

## Freezing the Picture

FREEZE



- ▶ **Useful when:**
- ▶ You want to perform a computer operation which is irrelevant to the proceedings of the presentation.
- ▶ You want to stop a moving image.

Freeze the moving image.

### Freezing an Image



The "FREEZE" message is shown on the screen.

### Canceling the FREEZE function

Press the  button again to cancel the FREEZE function.



- You can expand or reduce the frozen image (P69).
- The (left and right) LED illumination lamps on the top control flashes slowly while stopping the image.
- A guiding message appears if you press an invalid button while the FREEZE function is on.

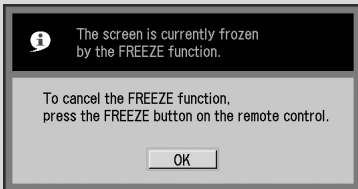

## Adjusting the Volume

VOL



- ▶ **Useful when:**
- ▶ You want to adjust the volume level of the projector's speaker.

### Adjusting the Volume

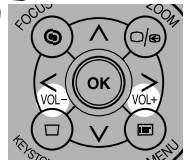

Volume bar appears on the screen.

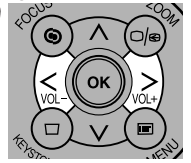
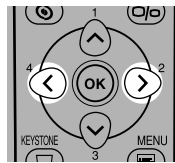

- Adjust the volume or mute setting on the computer if the volume level is too low.

## Showing the Elapsed Time

P-TIMER



- ▶ Useful when:
- ▶ You want to manage the proceedings of the presentation.

The elapsed time from 00:00 to 59:59 is displayed at the lower right corner of the screen.

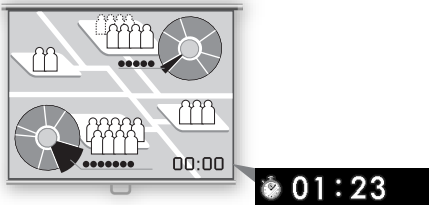

### Starting the Countdown



Press this button once to display the timer and start counting.

### Stopping the Countdown

Press the  button again to stop the countdown.

### Canceling the Countdown

Press the  button again to disappear the timer.

## Pointing with a Spotlight

SPOT



- ▶ Useful when:
- ▶ You want to point to a portion of an image that should draw attendees' attention.

Highlight a desired portion of the projected image with a spotlight.

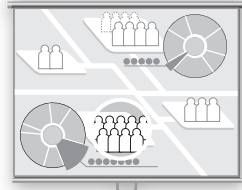

### Showing the Spotlight



A spotlight appears at the center of the screen and the image becomes dark except for the spotlight.

Press the  button repeatedly to change the shape of the spotlight.

### Moving the Spotlight

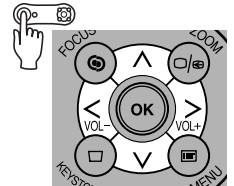
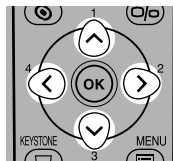

Move the spotlight to a desired position.

- Press the [OK] button to cancel the SPOT function.

## Zooming an Image



D.ZOOM



### ► Useful when:

- Zoom in an object such as a small graph during a presentation.
- Moving unnecessary information off the screen to focus on the current subject.

Zoom the projected image.

### Zooming In an Image



Press this button repeatedly until the image becomes the desired size.

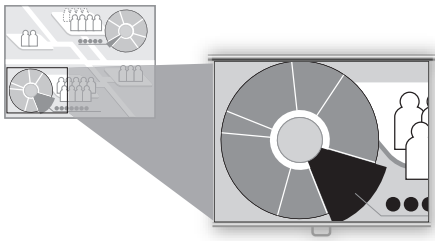

- The magnification appears on the screen when you press the [D.ZOOM] button.
- The zoom ratio is 1x to 12x.
- You can freeze the enlarged image.
- Press the [OK] button to cancel the digital zoom function.
- The following guiding message appears if you press an invalid button during operating the digital zoom function.

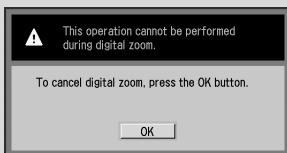

### Moving an Image to the Desired Position

If the image you want to zoom in stays out of the screen or out of the center of the screen, you can move it to the desired position.

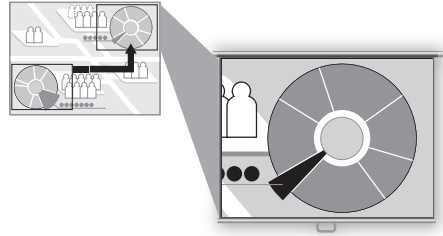
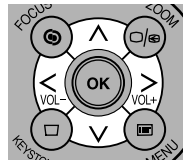
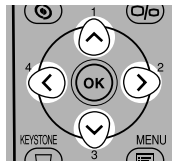

### Zooming Out an Image



Press this button repeatedly until the image becomes the desired size.

## Operating a Mouse with the Remote Control



- ▶ Useful when:
- ▶ You want to operate a mouse with the remote control.

You can use the supplied remote control as the wireless mouse for your computer.

### Connecting a USB Cable

Make sure that both the computer and projector are turned off, and then connect the supplied USB cable between the USB terminals on the computer and the projector.

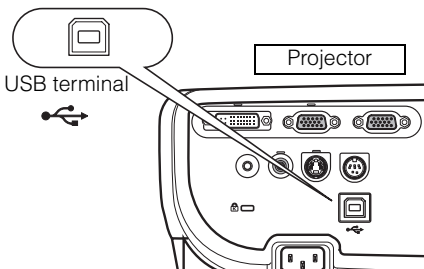
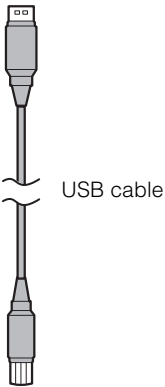
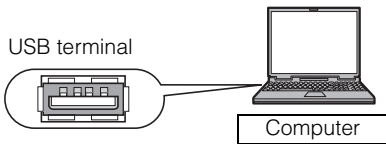

- This function is supported on Windows XP, Windows 2000, Windows Me, or Mac OS 9.2 and later.

### Moving the Cursor

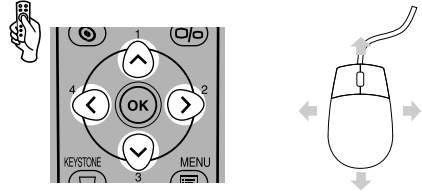

You can move the mouse cursor vertically and horizontally.

### Using the Left Button of the Mouse

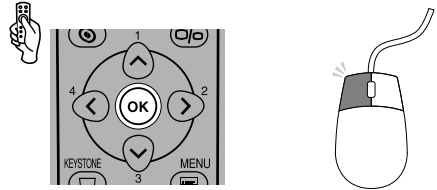

You can click, double-click, or drag an object with this button.

### Using the Right Button of the Mouse

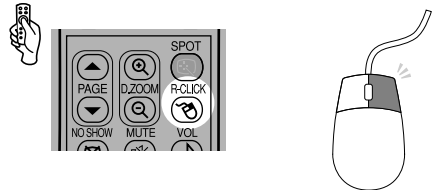

## Page Up or Down through the Pages



PAGE



### ► Useful when:

- You want to page up or down through the projected application pages with the remote control.

You can page up or down in the projected application with the supplied remote control.

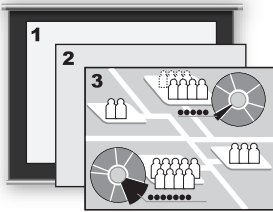

### Page Up



### Page Down



- This function acts as the Page Up and Page Down keys on the computer keyboard. You can not use this function depending on the application.





# SETTING UP FUNCTIONS FROM MENUS

Safety Instructions

Before Use

Setting Up the Projector

Projecting an Image from the Computer

Projecting an Image from AV Equipment

Useful Functions Available During a Presentation

**Setting Up Functions from Menus**

Maintenance

Troubleshooting

Appendix

Index

# Setting Up Functions from Menus

## How to Use Menus

Some of the projector's function are used through the menu screen. It consists of following three menus.

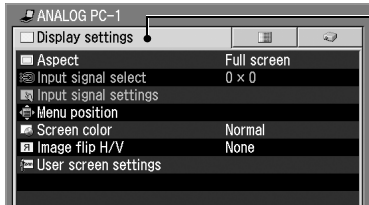

### Display settings menu (P78)

This menu is used to select an input signal and make various settings related to display.

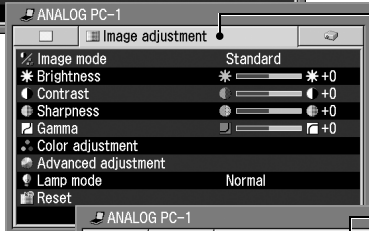

### Image adjustment menu (P89)

This menu is used to make various adjustments to the projected image. You can make the adjustments according to your preference while checking the image.

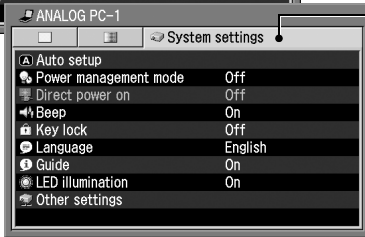

### System settings menu (P96)

This menu is used to set various functions of the projector. You can set them regardless of the input signal.

- \* The menu items may differ depending on the input signal.  
The projector stores the settings for each input signal (8) and image mode (up to 5).

### Symbols Indicating Item Categories

Menu items are classified into two categories, menu items used to project the image from the computer and menu items used to project the image from the AV equipment.



Menu item used when projecting an image from the computer.

**DIGITAL PC**

DIGITAL PC input

**ANALOG PC**

ANALOG PC-1/ANALOG PC-2 input



Menu item used when projecting an image from AV equipment.

**DIGITAL VIDEO**

DIGITAL VIDEO input

**COMP.**

COMPONENT input

**SCART**

SCART input

**COMP./SCART**

COMPONENT input/SCART input

**VIDEO/S-VIDEO**

VIDEO input/S-VIDEO input

This section provides the basic operation on the menu.

## 1 Press the [MENU] button.

A menu window appears.

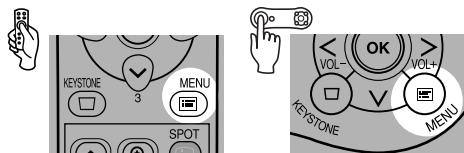

- Press the [MENU] button again to close the menu window.

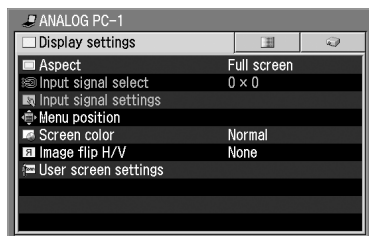

## 2 Press [<] / [>] to select the appropriate tab.

Press [^] to move the cursor on the tab if it is not on it.

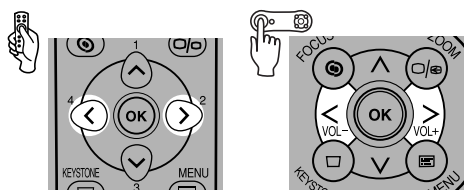
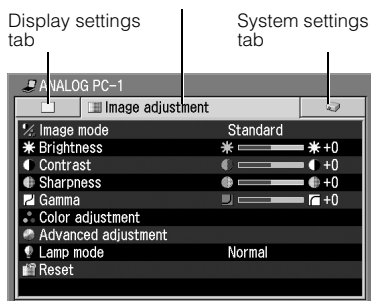
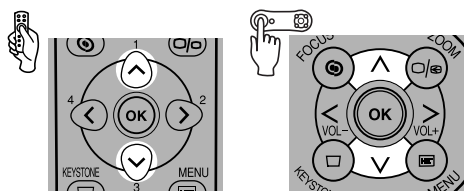

Image adjustment tab (Image adj.)



## 3 Press [v] to select a menu item you want to set.

You can also use [^] to select the menu item.



- Some menu items provide more detailed menu items.

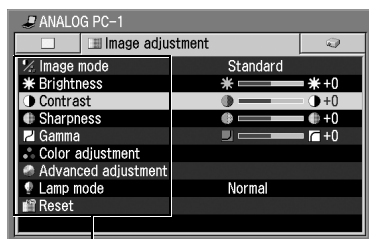

Menu items

## 4 Set the menu item.

There are four types of menu items that you make a setting:

- Directly
- From a list
- With a slider
- In a different screen

### ● Directly

Example: Tracking

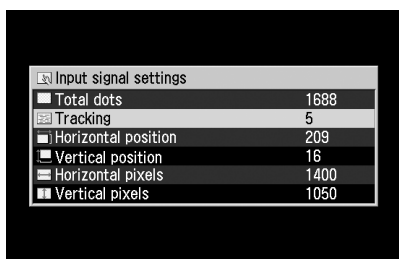

Press [**<**] [**>**] to increase/decrease the setting.

### ● From a list

Example: Aspect

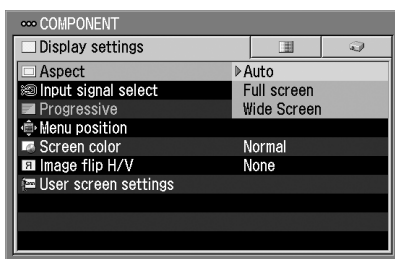

Press the [**OK**] button to display a list.

Press [**v**] [**^**] to select a desired setting.

### ● With a slider

Example: Contrast

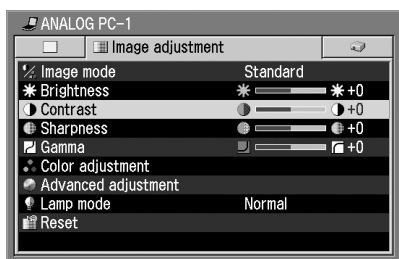

Press [**<**] [**>**] to move the slider.

### ● In a different screen

Example: Menu position

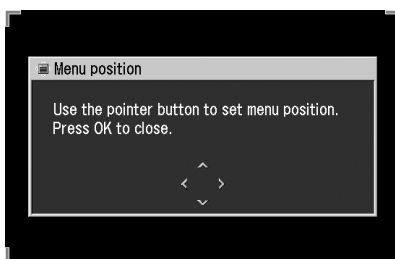

Press the [**OK**] button to display a different screen. Then follow the instruction on the screen.

---

**5** Press the [OK] button.

In some menu items, the setting is enabled just by making a selection.

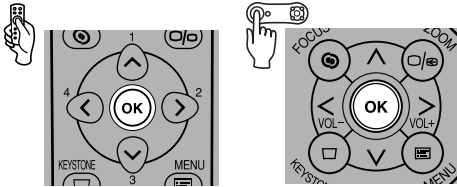

---

**6** Press the [MENU] button when you finish.

The menu disappears.

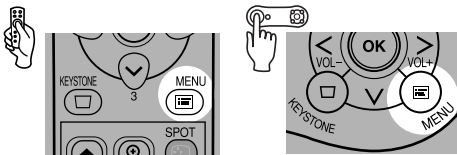

# Setting Display Status from the Display Settings Menu

## Selecting a Screen Mode (1)

[Aspect]

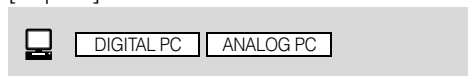

You can adjust the aspect ratio of the image projected on the screen.

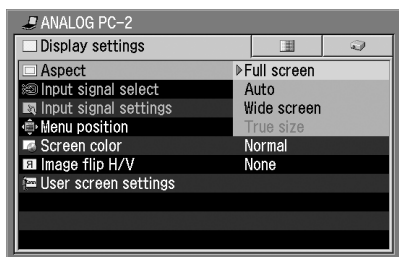
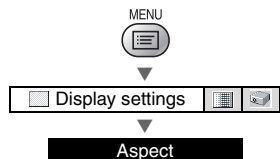

- Full screen Projects a full computer screen fully on the screen.
- Auto Projects an input signal image in the maximum size with the aspect ratio unchanged.
- Wide Screen Projects a computer screen at 16:9 aspect ratio with its width matching to the width of the projecting area.
- True size Projects a computer screen in its original size (no enlargement/reduction).

Press the [MENU] button when you finish.

- Circles may become out of round depending on the display resolution of the computer if Full screen is selected.
- The upper, lower, left, and/or right portions of a projected image may be missing depending on the selected display mode.
- You cannot select [True size] depending on the input signal.

## Selecting a Screen Mode (2)

[Aspect]



You can adjust the aspect ratio of the image projected on the screen.

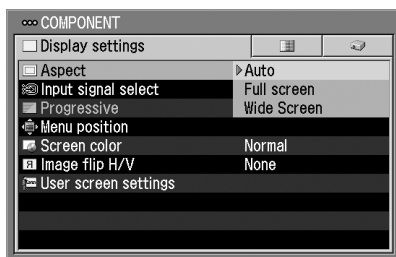
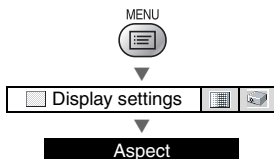

- Auto Switches between [Full screen] and [Wide Screen] automatically in accordance with the video image (COMPONENT input only).
- Full screen Projects a video image with aspect ratio of 4:3.
- Wide Screen Projects a video image with aspect ratio of 16:9.

Press the [MENU] button when you finish.

- The upper, lower, left, and/or right portions of a projected video image may be missing depending on the selected display mode.

## Selecting a Screen Mode (3)

[Aspect]

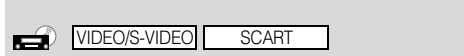

You can adjust the aspect ratio of the image projected on the screen.

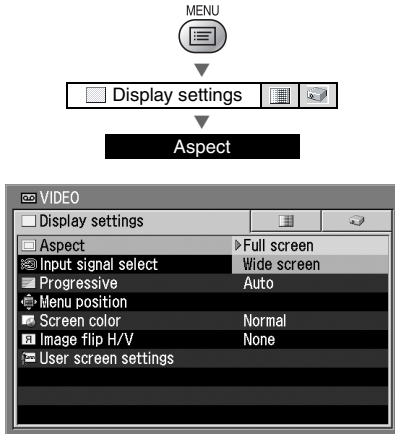

- Full screen Projects a video image with aspect ratio of 4:3.
- Wide Screen Projects a video image with aspect ratio of 16:9.

Press the [MENU] button when you finish.



- The upper, lower, left, and/or right portions of a projected video image may be missing depending on the selected display mode.

## Selecting an Input Signal Type (1)

[Input signal select]



You can select a desired input signal type if the auto PC adjustment function detects more than one input signal types.

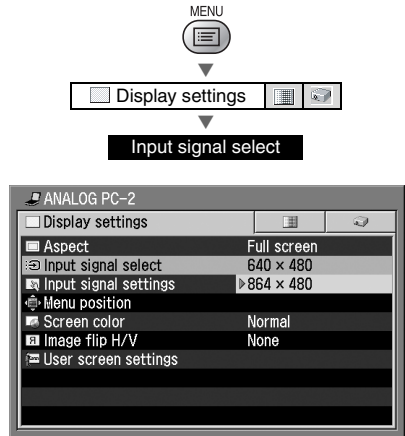

Select an input signal type suitable for the computer from the displayed signal types. Press the [MENU] button when you finish.



- See P118 for the signal types supported by this projector.

## Selecting an Input Signal Type (2)

[Input signal select]



You can select an input signal type manually if a video image from a AV equipment is not projected correctly (irregular color or no image).

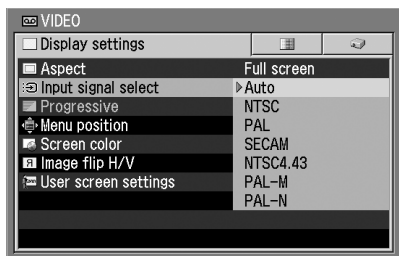
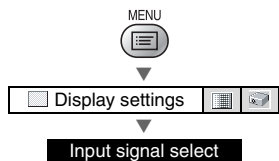

- Auto Selects the input signal automatically.
- NTSC Select one of input signal types shown on the left if video image is not projected correctly in the [Auto] mode.
- PAL
- SECAM
- NTSC4.43
- PAL-M
- PAL-N

Press the [MENU] button when you finish.



- Confirm the input signal type according to the User's Manual that came with the AV equipment connected.

## Selecting an Input Signal Type (3)

[Input signal select]



You can select an input signal type manually if a video image from a AV equipment is not projected correctly.

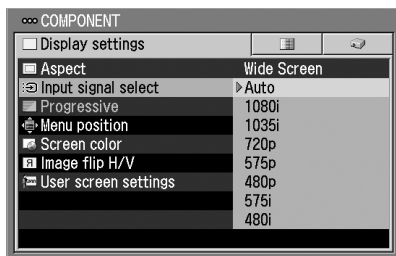
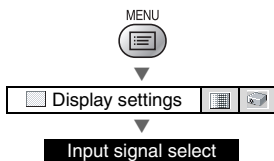

- Auto Selects the component format automatically according to the input signal.
- 1080i
- 1035i
- 720p
- 575p
- 480p
- 575i
- 480i

Press the [MENU] button when you finish.



- Confirm the input signal type according to the User's Manual that came with the AV equipment connected.



## Adjusting the Total Number of Dots

[Total dots]



You can adjust the total number of dots in the horizontal direction.

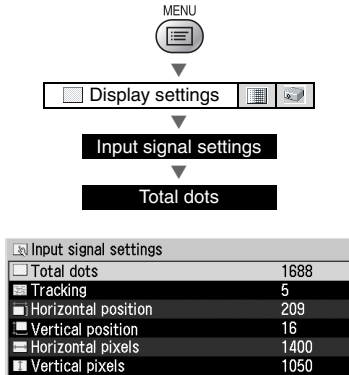

- > Increases the total number of dots.
- < Decreases the total number of dots.

Press the [MENU] button when you finish.



- Perform this adjustment if the auto PC adjustment function cannot adjust the project image correctly.
- The setting is recorded for [ANALOG PC-1] and [ANALOG PC-2] separately.

## Adjusting the Tracking

[Tracking]



You can adjust the tracking when the projected image flickers due to a tracking error.

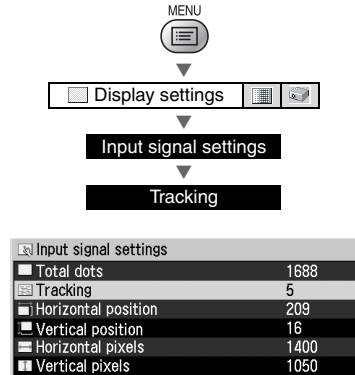

- > Increases the set value.
- < Decreases the set value.

Press the [MENU] button when you finish.



- Perform this adjustment if the auto PC adjustment function cannot adjust the project image correctly.
- The setting is recorded for [ANALOG PC-1] and [ANALOG PC-2] separately.

## Adjusting the Horizontal Position

[Horizontal position]



ANALOG PC

You can adjust the horizontal position of the screen when the projected image is shifted in the horizontal direction.

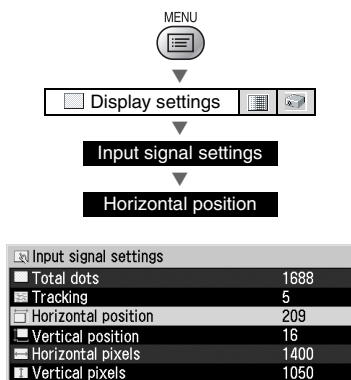

> Moves the screen to the right.

< Moves the screen to the left.

Press the [MENU] button when you finish.



- Perform this adjustment if the auto PC adjustment function cannot adjust the project image correctly.
- The setting is recorded for [ANALOG PC-1] and [ANALOG PC-2] separately.

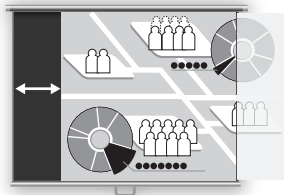

## Adjusting the Vertical Position

[Vertical position]



ANALOG PC

You can adjust the vertical position of the screen when the projected image is shifted in the vertical direction.

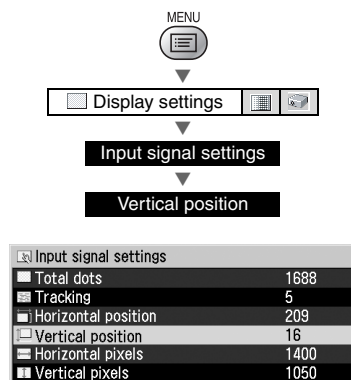

> Moves the screen up.

< Moves the screen down.

Press the [MENU] button when you finish.



- Perform this adjustment if the auto PC adjustment function cannot adjust the project image correctly.
- The setting is recorded for [ANALOG PC-1] and [ANALOG PC-2] separately.

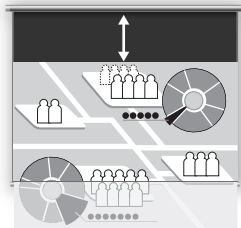

## Adjusting the Number of Horizontal Pixels

[Horizontal pixels]



ANALOG PC

You can adjust the number of the pixels in the horizontal direction if the length of the screen is too long or too short in the horizontal direction.

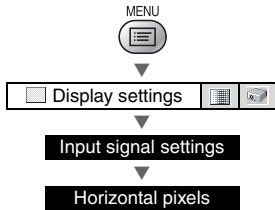

Input signal settings	
Total dots	1688
Tracking	5
Horizontal position	209
Vertical position	16
Horizontal pixels	1400
Vertical pixels	1050

> Increases the number of pixels in the horizontal direction.

< Decreases the number of pixels in the horizontal direction.

Press the [MENU] button when you finish.



- Perform this adjustment if the auto PC adjustment function cannot adjust the project image correctly.
- The setting is recorded for [ANALOG PC-1] and [ANALOG PC-2] separately.

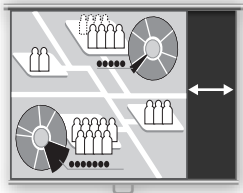

## Adjusting the Number of Vertical Pixels

[Vertical pixels]



ANALOG PC

You can adjust the number of the pixels in the vertical direction if the length of the screen is too long or too short in the vertical direction.

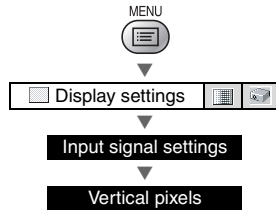

Input signal settings	
Total dots	1688
Tracking	5
Horizontal position	209
Vertical position	16
Horizontal pixels	1400
Vertical pixels	1050

> Increases the number of pixels in the vertical direction.

< Decreases the number of pixels in the vertical direction.

Press the [MENU] button when you finish.



- Perform this adjustment if the auto PC adjustment function cannot adjust the project image correctly.
- The setting is recorded for [ANALOG PC-1] and [ANALOG PC-2] separately.

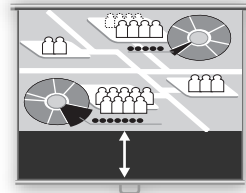

## Performing Progressive Processing [Progressive]



You can use the progressive processing function if you want to project a high-quality video image.

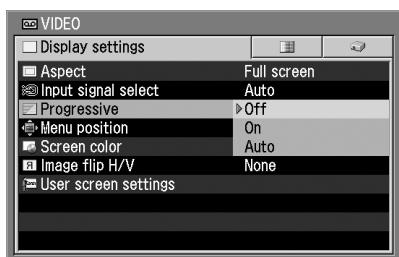
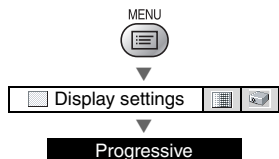

- On Performs the progressive processing.
- Off Does not perform the progressive processing.
- Auto Performs the appropriate progressive processing depending on the input signal.

Press the [OK] button to confirm, and then press the [MENU] button.

- You cannot use this function if the component signal is 1080i, 1035i, 720p, 575p, or 480p.
- This setting is saved for the currently selected input signal.
- Select [Off] when flickers and horizontal lines are noticeable on a fast-moving picture.
- See P121 for more detailed information on the progressive processing.

## Selecting a Menu Position [Menu position]

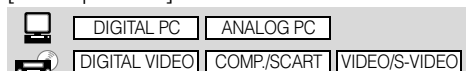

You can select the position of the menu displayed on the screen.

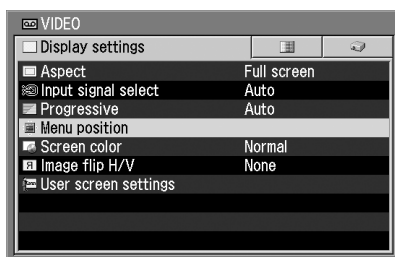
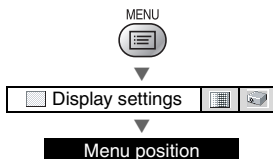

Move the menu to the desired position with [▲], [▼], [◀], and [▶], and then press the [OK] button.

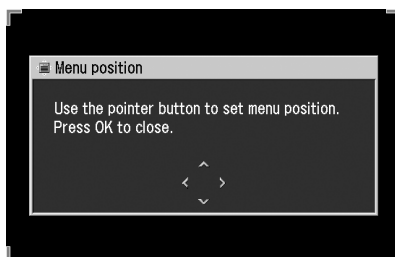

Press the [MENU] button when you finish.

## Performing the Ceiling-mounted/Rear Projection

[Image flip H/V]

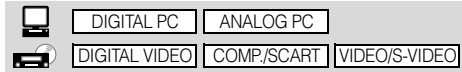

You can make this setting if you want to hang the projector from the ceiling or project an image on a transmissive screen.

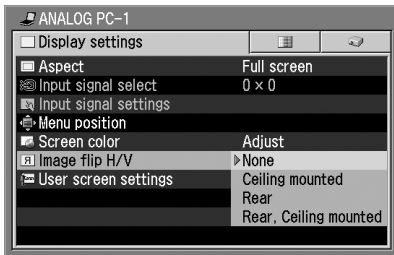
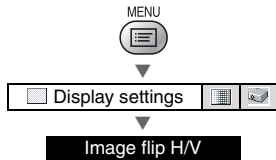

- None Select this if you project an image normally.
- Ceiling mounted Select this if you project an image with the projector hung from the ceiling. The projected image is inverted in both vertical and horizontal directions.
- Rear Select this if you project an image from behind the screen. The projected image is inverted in the horizontal direction.
- Rear, Ceiling mounted Select this if you project an image from behind the screen with the projector hung from the ceiling. The projected image is inverted in the vertical direction.

Press the [MENU] button when you finish.

None (Normal image)

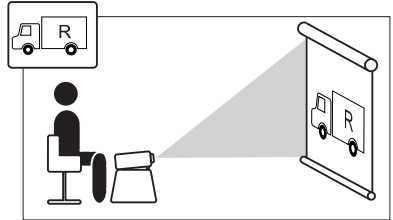

Ceiling mounted

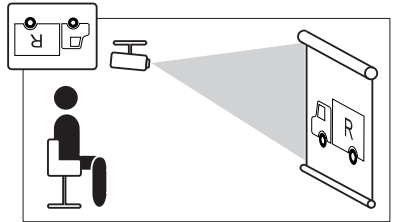

Rear

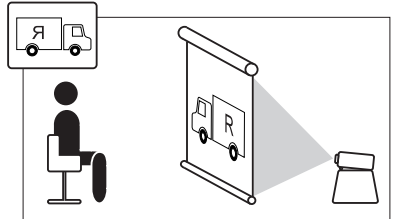

Rear, Ceiling mounted

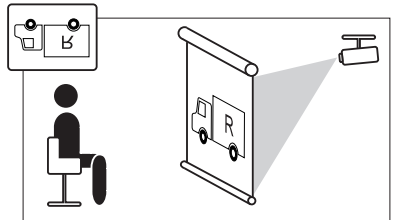

- When hanging the projector from the ceiling, make sure to use optional brackets. Contact your Canon dealer.

## Correcting the Screen Color

[Screen color]

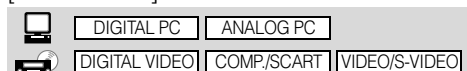

You can adjust the white balance so that white portions of the image are displayed correctly.

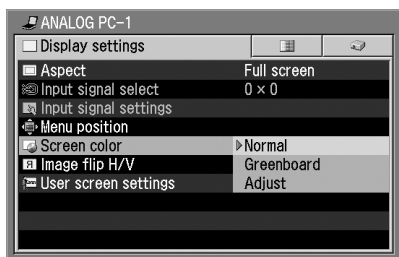
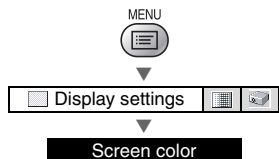

- Normal Projects an image in a color tone similar to that of natural light on a standard screen.
- Greenboard Projects an image in an almost natural color tone on a greenboard (dark green).
- Adjust Adjusts color tone with the level meter. To adjust the color tone automatically, press the [AUTO SET] button when the following level meter is displayed. Use this function if the [Greenboard] setting is inadequate.

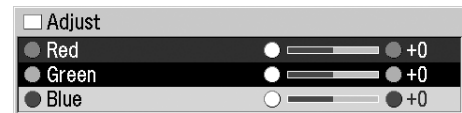

If you manually adjust it, press [^] or [v] button to select red, green, or blue.

[>] Increases the color tone of each color.

[<] Decreases the color tone of each color.

Press the [OK] button to confirm, and then press the [MENU] button.

## Capturing a Logo to Be Projected

[Logo capture]

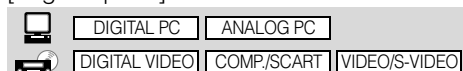

You can project a desired image (logo) when you turn on the projector, there is no input signal, or you blacken a projecting image temporarily.

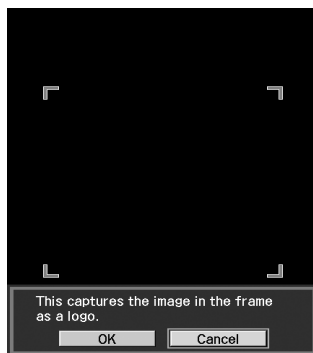
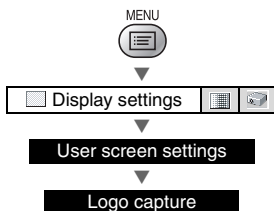

- OK Projects the image to be captured on the screen. Surround the capturing area with the red frame and press [OK]. The image in the red frame is captured.
- Cancel Cancels the image capturing.

Press the [OK] button to confirm, and then press the [MENU] button.

- You can capture only one image.
- Select [User logo] on the [Projector on], [No signal screen], or [NO SHOW] menu item.
- You may not capture an image depending on the resolution and scan system.

## Selecting a Logo Display Position

[Logo position]

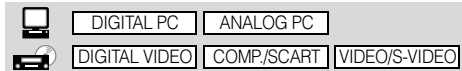

You can select a logo display position. You can place the logo at the center or a corner of the screen as you wish.

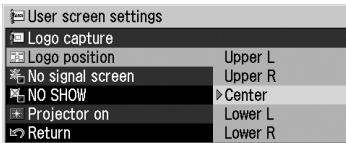
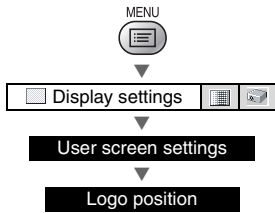

- Select a position you want to display a logo and press the [OK] button.
- 
- 
- 
- 

Press the [MENU] button when you finish.

- You cannot select [Logo position] if you have not captured a logo on the [Logo capture] screen.

## Displaying a Logo (No signal screen)

[No signal screen]

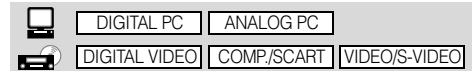

You can display a logo on a screen when there is no input signal.

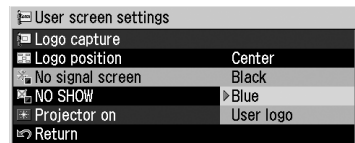
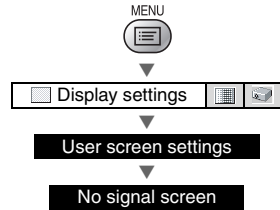

- Displays no logo (black screen).
- Displays no logo (blue background).
- Displays a logo captured on the [Logo capture] screen.

Press the [OK] button to confirm, and then press the [MENU] button.

- You cannot select [User logo] if you have not captured a logo on the [Logo capture] screen.

## Displaying a Logo (NO SHOW)

[NO SHOW]

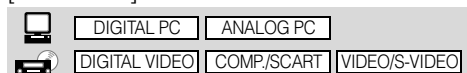

You can display a logo on a screen when the projected image is blackened out temporarily by pressing the [NO SHOW] button.

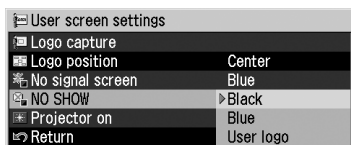
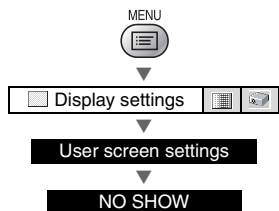

- Black Displays no logo (black screen).
- Blue Displays no logo (blue background).
- User logo Displays a logo captured on the [Logo capture] screen.

Press the [OK] button to confirm, and then press the [MENU] button.

-  You cannot select [User logo] if you have not captured a logo on the [Logo capture] screen.

## Selecting a Logo at Startup

[Projector on]

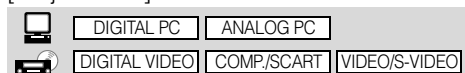

You can display a specified logo on a screen from the moment the projector is turned on to the moment it is ready for projection.

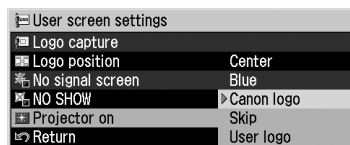
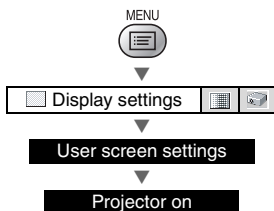

- Canon logo Displays the Canon logo captured at the factory.
- Skip Projects an image immediately after turning on the projector.
- User logo Displays a logo captured on the [Logo capture] screen.

Press the [OK] button to confirm, and then press the [MENU] button.

-  You cannot select [User logo] if you have not captured a logo on the [Logo capture] screen.



# Setting the Image Quality from the Image Adjustment Menu

## Selecting an Image Mode

[Image mode]

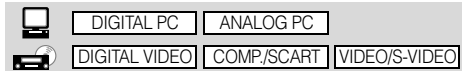

You can select an image mode suitable for the projecting image.

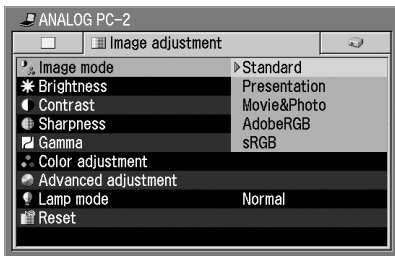
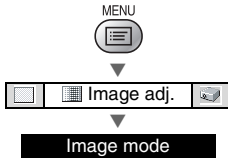

(SX6)

**Standard** Select this to project an image with near-original quality and a high regard for reproduction of white. It is also suited to project moving pictures such as a TV program or a DVD movie in a bright room.

**Presentation** Select this to project an image with quality suited for the presentation. It is also suited to project moving pictures with a high regard for the brightness.

**Movie** Select this to project moving pictures of all kinds. Its brightness is suited to easily enjoy the atmosphere of a movie theater in a dim room.

**Movie&Photo** Select this to project an image or moving pictures with quality suited for those shot by a digital camera or so.

**sRGB** Select this if you want to project an image in the display mode conforming to Windows standard color space. It is suited to project an image shot by an sRGB-compatible digital camera.

**AdobeRGB** Select this if you want to project an image in the display mode conforming to Adobe RGB color space. You can project an image with more accurate color reproduction since its has wider color gamut than sRGB.

**Home Cinema** Select this to project a movie with quality suited to seriously enjoy the atmosphere of a movie theater in a dark room.

SX6	SX60	X600
Standard	Standard	Standard
Presentation	Presentation	Presentation
Movie&Photo	Movie	Movie
AdobeRGB	Home Cinema	sRGB
sRGB	sRGB	

Press the [OK] button to confirm, and then press the [MENU] button.



- You can adjust the image quality (brightness, contrast, etc.) for each image mode as you wish.
- The projector stores the image quality settings for each input signal (8) and image mode (up to 5) separately.

## Adjusting the Brightness

[Brightness]

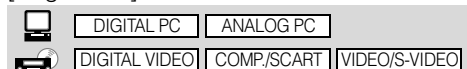

You can adjust the brightness of an image when it is too bright or dark.

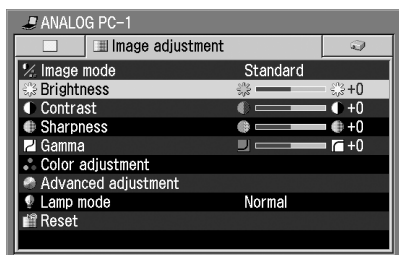
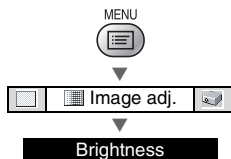

> Increases the brightness of an image.

< Decreases the brightness of an image.

Press the [MENU] button when you finish.

- This setting is saved for the currently selected input signal and image mode.

## Adjusting the Contrast

[Contrast]

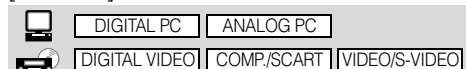

You can adjust the contrast of an image if you want to make it more or less vivid, adjust the difference in tone between the lightest and darkest portions of the image.

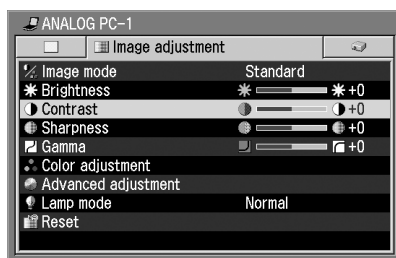
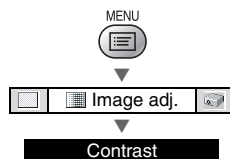

> Increases the contrast of an image. The image becomes more vivid.

< Decreases the contrast of an image. The image becomes less vivid.

Press the [MENU] button when you finish.

- This setting is saved for the currently selected input signal and image mode.

## Adjusting the Sharpness

[Sharpness]

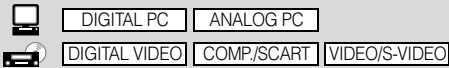

You can adjust the sharpness when you want to make an image sharper or softer.

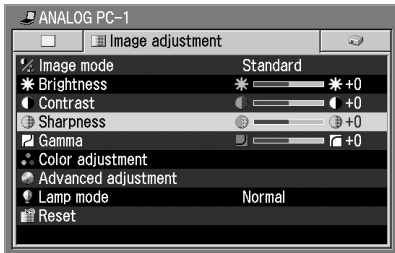
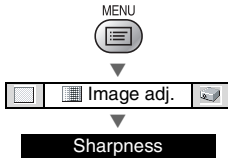

- Increases the sharpness of an image.
- Decreases the sharpness of an image.

Press the [MENU] button when you finish.



- This setting is saved for the currently selected input signal and image mode.

## Making a Gamma Correction

[Gamma]

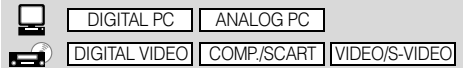

You can make a gamma correction if light or dark portions of an image are obscure.

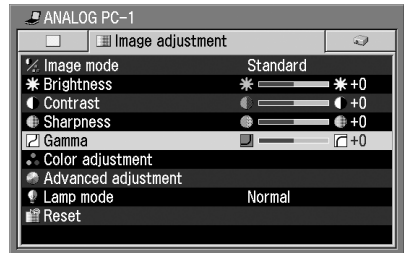
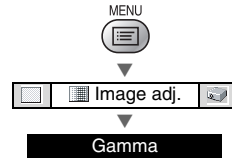

- Makes dark and obscure portions of an image visible.
- Makes light and obscure portions of an image visible.

Press the [MENU] button when you finish.



- This setting is saved for the currently selected input signal and image mode.

## Making Color Adjustment (1)

[Color adjustment]

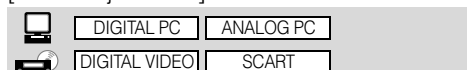

You can make color adjustment for each color (red, green, and blue).

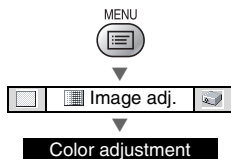

**R/G/B Gain** Adjusts the intensity of each color.

[>] Increases the intensity of color.

[<] Decreases the intensity of color.

**R/G/B Offset** Adjusts the color reproducibility of dark portions of each color.

[>] Increases the color reproducibility of color.

[<] Decreases the color reproducibility of color.

Press the [MENU] button when you finish.

- This setting is saved for the currently selected input signal and image mode.

## Making Color Adjustment (2)

[Color adjustment]

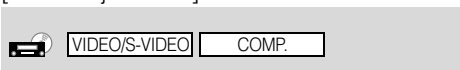

You can adjust color level and color balance and make color adjustment for each color (red, green, and blue).

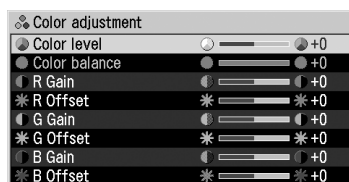
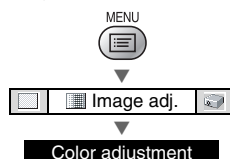

**Color level** Adjusts the intensity of each color.

[>] Increases the intensity of color.

[<] Decreases the intensity of color.

**Color balance** Adjusts the color balance of a reddish or greenish image.

[>] Corrects a reddish image.

[<] Corrects a greenish image.

**R/G/B Gain** (Refer to "Making Color Adjustment (1)")

**R/G/B Offset** (Refer to "Making Color Adjustment (1)")

Press the [MENU] button when you finish.

- You cannot make color adjustment if the video format is PAL, PAL-M, PAL-N, or SECAM.
- This setting is saved for the currently selected input signal and image mode.

## Making Advanced Color Adjustment (1)

[Dynamic gamma]

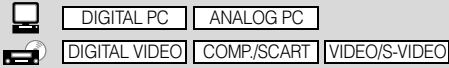

You can adjust the gradation representation of light and dark portions of an image automatically.

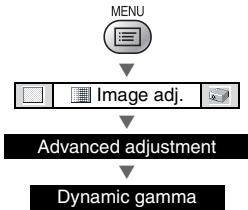

Enables dynamic gamma.

Disables dynamic gamma.

Press the [OK] button to confirm, and then press the [MENU] button.



- Dynamic gamma automatically optimizes image quality in real time.
- This setting is saved for the currently selected input signal and image mode.

## Making Advanced Color Adjustment (2)

[Mem. color correct]

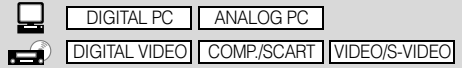

You can correct colors (e.g. blue sky) in our memory so that they can be projected more vividly.

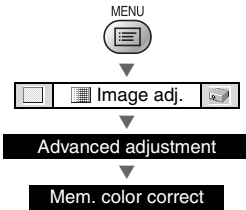

Disables the memorized color correction function.

Specifies the intensity of the memorized color correction in three steps.

Press the [MENU] button when you finish.



- This setting is saved for the currently selected input signal and image mode.

## Making Advanced Color Adjustment (3)

[6-axis color adjust]

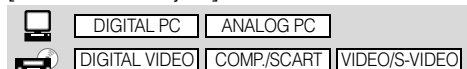

You can make fine color adjustment with the 6-axis color adjustment box (RGB (red/green/blue) and CMY (cyan/ magenta/yellow)).

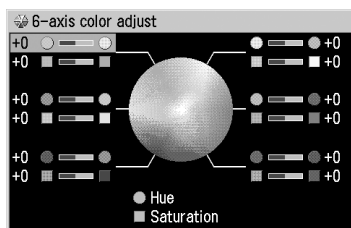
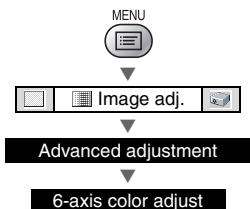

- Adjust Enables the 6-axis color adjustment.
- Off Disables the 6-axis color adjustment.

The 6-axis color adjustment box appears on the screen if you select [Adjust].

Press [ $\wedge$ ] / [ $\vee$ ] to select the [Hue] or [Saturation] slider, and press [<] / [>] to make an adjustment.

Press the [MENU] button when you finish.

- This setting is saved for the currently selected input signal and image mode.

## Reducing the Lamp Brightness

[Lamp mode]

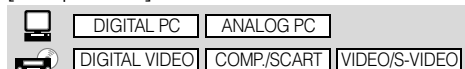

You can reduce the lamp brightness if you want to make the image darker or reduce the fan noise.

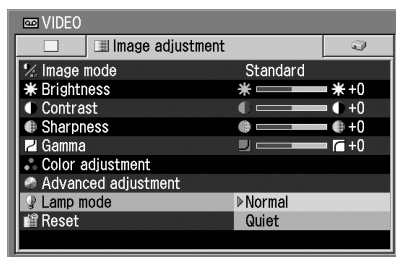
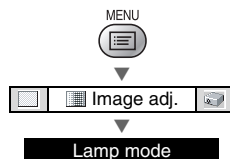

- Normal Projects an image at the normal brightness level.
- Quiet Reduces the lamp brightness and the fan noise.

Press the [OK] button to confirm, and then press the [MENU] button.

- You can reduce the power consumption of the lamp if you select in the quiet mode.
- This setting is saved for the currently selected input signal and image mode.

## Resetting the Image Settings

[Reset]

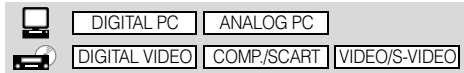

You can reset the current image settings to the default settings if you want to make all image settings all over again.

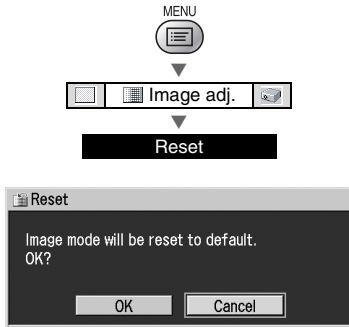

Resets the image settings.

Cancels resetting of the image settings.

Press the [OK] button to confirm, and then press the [MENU] button.



- The projector stores the image settings for each input signal (8) and image mode (up to 5) separately. If you select [OK], the settings saved for the currently selected set of the input signal and image mode are reset.

Performing [Color adjustment] or [Advanced adjustment]:

A check mark (☑) appears on the Image Adjustment menu if you perform [Color adjustment] or [Advanced adjustment] (Dynamic gamma, Mem. color correct, or 6-axis color adjust ).

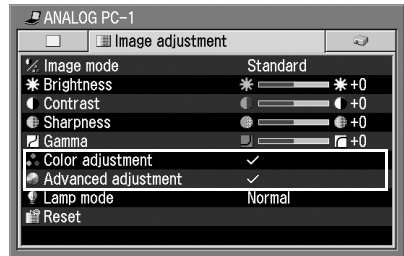

# Setting Various Function with the System Settings Menu

## Setting Auto Setup Function

[Auto setup]

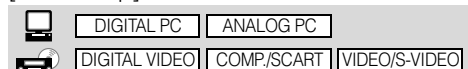

You can select an item you want to enable in the auto setup function.

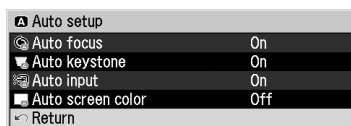
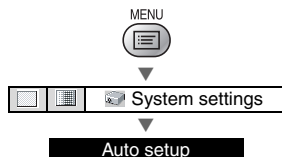

Select [On] or [Off] for the following items if you want to enable or disable them in the auto setup function, respectively.

- Auto focus    Enables/disables the auto focusing.
- Auto keystone    Enables/disables the auto keystone correction.
- Auto input    Enables/disables the auto input selection.
- Auto screen color    Enables/disables the auto screen color correction.

- A confirmation screen appears during the auto setup so that you can check which functions are enabled/disabled (P41, 60).
- You can manually adjust each item.
  - [Auto focus]: [FOCUS] button (P46)
  - [Auto keystone]: [KEYSTONE] button (P47)
  - [Auto input]: [INPUT] button (P43, 61)
  - [Auto screen color]: Menu function (P86)

## Selecting the Power Management Mode

[Power management mode]

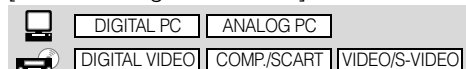

You can turn off the lamp or projector automatically for saving power.

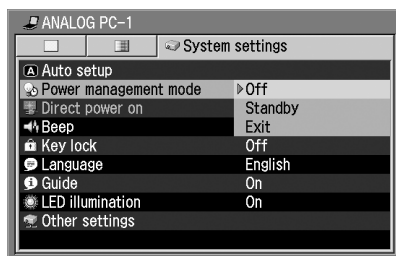
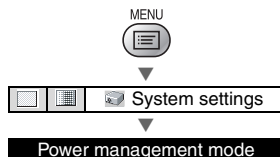

- Off    Disables the power management mode.
- Standby    Enters the power management mode. The projector restarts projection when a signal is inputted or any operation button is pressed.
- Exit    Enters the exit mode and turns off the projector automatically.

Press the [OK] button to confirm, and then press the [MENU] button.

- You cannot enable the [Direct Power on] function if you select [Off].
- The [POWER] indicator flashes red and green during the power management mode.



## Skip the POWER Button Operation

[Direct power on]

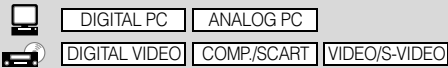

You can set the projector to be turned on when you connect the power cord.

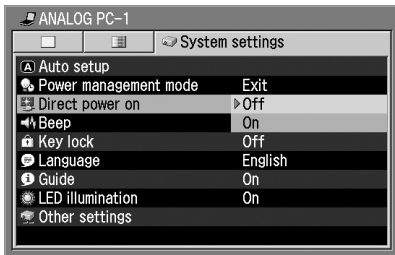
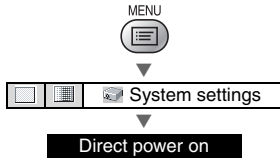

Off Enables the direct power on function.

On Disables the direct power on function.

Press the [OK] button to confirm, and then press the [MENU] button.



- Wait at least 5 minutes before turning on the projector when you turn off the projector with the direct power on function. It may shorten the lamp life if you turn on the projector immediately after turning it off.
- Set the previous [Power management mode] to [Standby] or [Exit] in addition to this setting if you want to enable the direct power on function.

## Enabling/Disabling the Beep

[Beep]

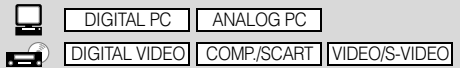

You can enable/disable the beep when you press a button on the top control or remote control.

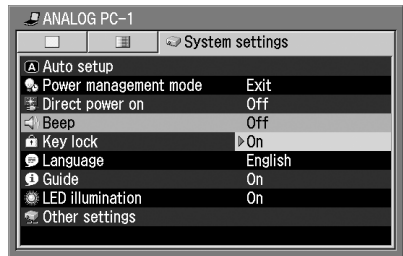
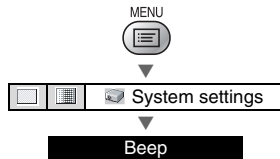

Off Disables the beep.

On Enables the beep.

Press the [OK] button to confirm, and then press the [MENU] button.



- It does not beep if you mute the projector sound temporarily with the [MUTE] button.

## Prohibiting the Projector Operation

### [Key lock]

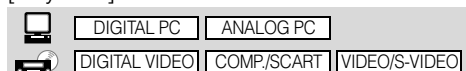

You can prohibit the use of the buttons on the top control or remote control to prevent them from being pressed by mistake.

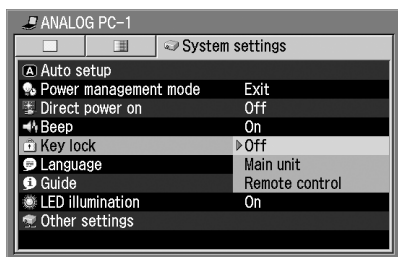
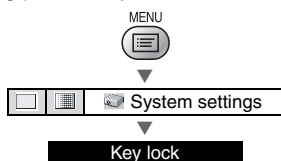

- Off Disables the key lock function.
- Main unit Prohibits the use of the top control.
- Remote control Prohibits the use of the remote control.

Press the [OK] button to confirm, and then press the [MENU] button.

- The key lock function becomes effective from the moment when the [OK] button is pressed after selecting [Main unit] or [Remote control]. Be sure to press the [OK] button on the top control or remote control which is not locked.
- To unlock the key lock function forcibly, remove the power plug from the AC outlet after the projection, and then insert the power plug while holding down the [OK] button until the projector beeps.

## Selecting a Display Language

### [Language]

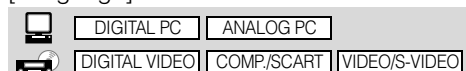

You can select a language to be used in the menu from 20 different languages.

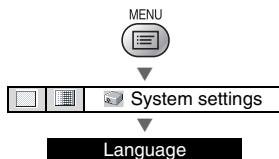

- English English
- Deutsch Germany
- Français French
- Italiano Italian
- Español Spanish
- Português Portuguese
- Svenska Swedish
- Русский Russian
- Nederlands Dutch
- Suomi Finnish
- Norsk Norwegian
- Türkçe Turkish
- Polski Polish
- Magyar Hungarian
- Čeština Czech
- Dansk Danish
- 中文简体 Simplified Chinese
- 中文繁體 Traditional Chinese
- 한국어 Korean
- 日本語 Japanese

Press the [OK] button and all words in the menu will be displayed in the selected language. Press the [MENU] button when you finish.

## Enabling/Disabling the Guide Message [Guide]

You can enable/disable the guide message showing how to use the projector.

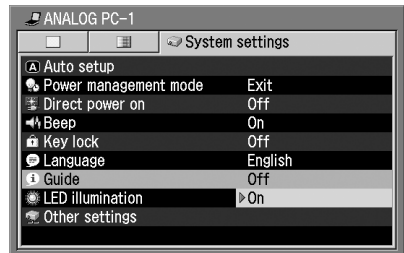
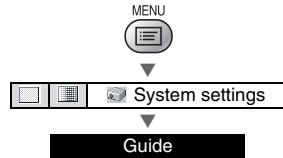

Disables the guide message.

Enables the guide message.

Press the [OK] button to confirm, and then press the [MENU] button.



- The guide message appears on the screen when:
  - The projector is turned on (P35).
  - The projector is turned off (the [POWER] button is pressed) (P53).
  - No input signal is confirmed (P32, 56).
  - The invalid button is pressed under NO SHOW, FREEZE, or D.ZOOM (P66, 67, 69).

## Turning On/Off the LED Illumination

[LED illumination]

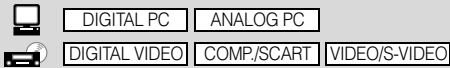

You can turn on/off the LED illumination lamp and the LEDs on the terminals (P24, 25).

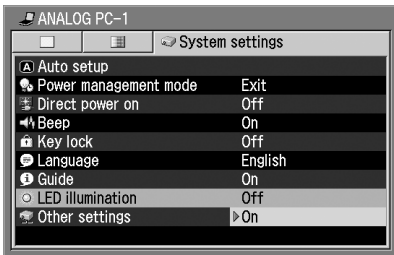
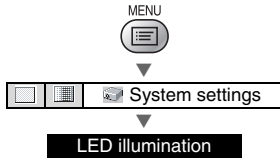

- Turns off all LEDs.
- Turns on LEDs as necessary.

Press the [OK] button to confirm, and then press the [MENU] button.

- This setting does not effect the POWER indicator or WARNING lamp.

## Setting up the Remote Control

[Remote control]

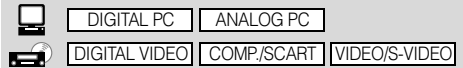

You can change the channel settings to prevent the two remote controls from interfering with each other when you use two projectors at the same time.

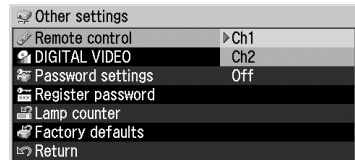
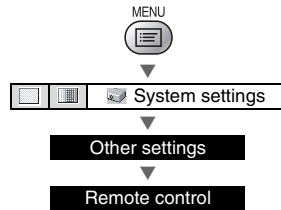

- Selects the channel on the projector you use.
- 

Press the [OK] button to confirm, and then press the [MENU] button.

### Selecting a Channel on the Remote Control

Press the [LIGHT] button for 3 seconds while holding down the [OK] button on the remote control.

The above operation toggles the channel between Ch1 (the button flashes once) and Ch2 (the button flashes twice).

- Make sure to set the same channel for both remote control and projector.
- Performing this operation with the remote control, you cannot control the projector after pressing the [OK] button. Make sure to change the channel for the remote control at the same time.

## Setting up the Digital Video Input Signal [Digital video]

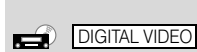

You can select the standard of the digital video input signal.

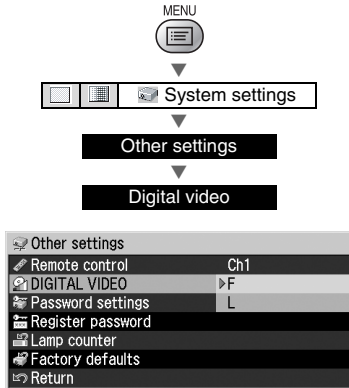

Projects a full range digital signal.

Projects a limited range digital signal.

Press the [OK] button to confirm, and then press the [MENU] button.



- Refer to the User's Manual that came with the AV equipment for more detailed information on settings.

## Setting a Password

[Password settings]

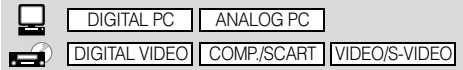

You can set a password to the projector.

Once you set the password, you will need to enter the password each time you turn on the projector.

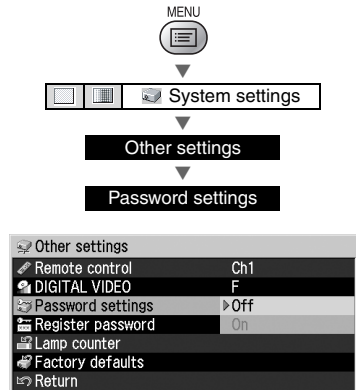

Disables the password protection.

Enable the password protection.

Press the [OK] button to confirm, and then press the [MENU] button.



- Once you set a password, the password entry screen appears at power-on. Enter a 4-digit password with [^], [v], [<], and [>]. If the password is valid, projection starts. If you enter a wrong password three times, the projector will be turned off.
- To cancel the password, remove the power plug from the AC outlet after the projection, and then insert the power plug while holding down the [MENU] button until the projector beeps.

## Registering a Password

[Register password]

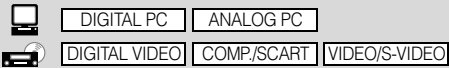

You can register a password that you need to enter when turning on the projector.

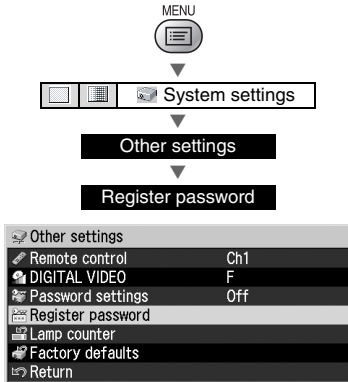

Press the [OK] button to display the password entry screen.



Enter a 4-digit password from the left. You can enter a value 1, 2, 3, and 4 by pressing [Λ], [∇], [<], and [>], respectively. Once you enter a value for all four digits, the password is registered automatically.



- Press the [MENU] button without entering a password if you want to cancel registering the password.

## Resetting the Lamp Counter

[Lamp counter]

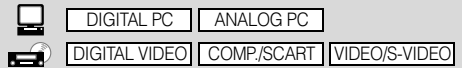

You can reset the lamp counter that indicates the timing to replace the projector when you replace it.

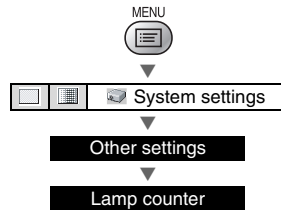

- If the time of use is less than 1,000 hours (1,840 hours for SX60)

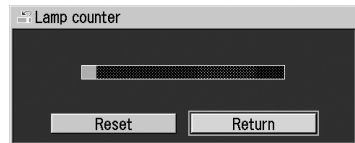

- If the time of use is 1,000 to 1,400 hours (1,840 to 2,500 hours for SX60)

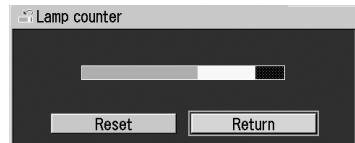

- If the time of use is 1,400 hours or longer (2,500 hours or longer for SX60)



- If you replace the lamp

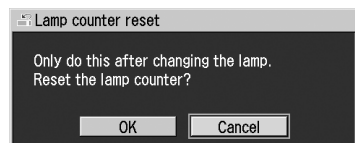

Resets the lamp counter.

Cancels resetting the lamp counter.

Press the [OK] button to confirm, and then press the [MENU] button.



- Do not reset the lamp counter except when you have replaced the lamp. Otherwise, the lamp counter cannot indicate the correct timing for replacing the lamp.



- See P108 for more detailed information on replacing the lamp.

## Resetting to the Factory Defaults

[Factory defaults]

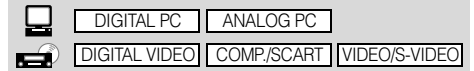

You can reset the menu item settings and restore the system settings to the factory defaults.

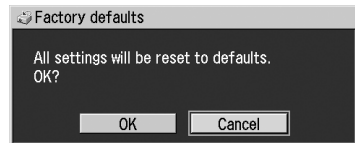
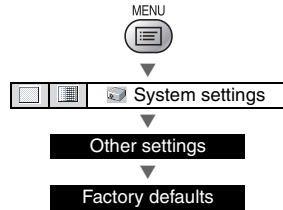

Resets the projector's menu item settings.

Cancels resetting the menu item settings.

Press the [OK] button to confirm, and then press the [MENU] button.



- The settings of [Lamp counter], [Language] and [Remote control] will not be reset even after resetting to the factory defaults.
- For the factory defaults, see P128, 129.





# MAINTENANCE

Safety Instructions

Before Use

Setting Up the Projector

Projecting an Image from the Computer

Projecting an Image from AV Equipment

Useful Functions Available During a Presentation

Setting Up Functions from Menus

**Maintenance**

Troubleshooting

Appendix

Index

# Maintenance

## Cleaning the Projector

Clean the projector frequently to prevent dust from settling on the surface. A dirty lens may ruin the quality of the projected image.



- The main unit is very hot immediately after turning off the projector. Wait until the projector cools down sufficiently before cleaning the projector. Otherwise, you may get burned or injured.
- Before cleaning the projector, be sure to remove the power plug from the AC outlet. Otherwise, electric shock or fire may result.

Wipe the projector's main unit softly with a soft cloth.

If the projector is heavily soiled, soak the cloth in water with a small amount of detergent in it, squeeze the cloth very well, and then wipe the projector with it. After cleaning, wipe the projector with a dry cloth.



- Never use volatile cleaning liquid or benzene, as these may damage the finish of the projector. When using a chemical dust cloth, make sure to read the instructions thoroughly.
- When cleaning the projector's lens, use a commonly available air blower or lens cleaning paper. The lens surface is easily damaged, so do not use a hard cloth or tissues.

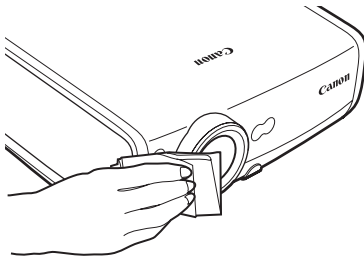

### When Not Used for an Extended Period of Time

Be sure to attach the lens cap on the lens and store in the supplied carrying bag.

---

## Cleaning and Replacing the Air Filter

---

An air filter is installed in the air intake vent on the bottom of the main body to protect the internal lens and mirror from dust. Should the air filter become clogged with dust, the projector may be damaged since it will block the air flow into the projector and raises the internal temperature of the projector.



**Caution**

- The main unit is very hot immediately after turning off the projector. Wait until the projector cools down sufficiently before cleaning the projector. Otherwise, you may get burned or injured.
- Before cleaning or replacing the air filter, be sure to remove the power plug from the AC outlet. Otherwise, electric shock or fire may result.
- Do not insert any object into the projector through the air filter opening. You may suffer electric shock or injury due to the high-voltage parts or rotating parts.

### Cleaning the Air Filter

Turn the projector upside down, remove the cover by pushing the latch, remove the air filter, and clean it with a vacuum cleaner.

When cleaning dust off the side exhaust vent and the bottom air intake vent, bring the vacuum cleaner nozzle close to them directly.



- Clean the air filter frequently.
- After cleaning the air filter, install it by following the removal steps in reverse.

### Replacing the Air Filter

- 1 Turn off the projector, remove the power plug from the AC outlet, and let the projector stand for at least 1 hour.
- 2 Remove the filter cover by pushing the position of the arrow.
- 3 Remove the air filter.
- 4 Install a new air filter.
- 5 Install the filter cover securely without any space.

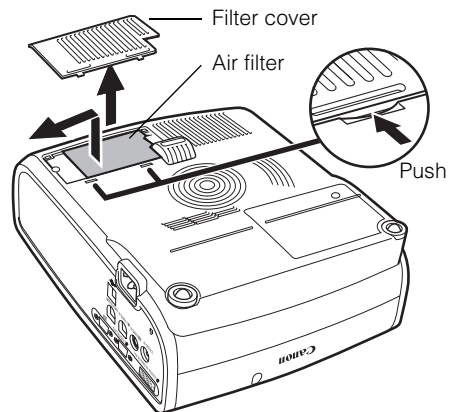

- Attach the lens cap when replacing the air filter.
- Handle the air filter carefully. If damaged, the air filter will not work appropriately.
- Replace the air filter whenever you replace the lamp.
- An air filter can be ordered from your dealer.

## Replacing the Lamp

When the time of use of the lamp exceeds 1,400 hours (2,300 hours for SX60), the following message (two types) is displayed for 10 seconds each time the projector is turned on.

- When the time of use is 1,400 to 1,500 hours:  
(2,300 to 2,500 hours for SX60)



\* [<], [>], the [OK] button, and the [POWER] button are available during this message is displayed.

- When the time of use is 1,500 hours or longer:  
(2,500 hours for SX60)

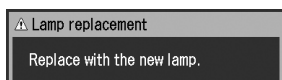

\* The [POWER] button is available during this message is displayed.



- This message will not be displayed again if you select [No] in response to the message "Do you want to display this message again?".
- You can check the time of use of the lamp in [Lamp counter] in the [System settings] menu (P102).



### Caution

- When replacing the lamp, turn off the projector, wait until the cooling fan stops, remove the power plug from the AC outlet, and let the projector stand for at least 1 hour. Otherwise, you may get burned because the main unit is very hot immediately after the projector is turned off.
- Do not touch the inner glass surface when you replace the lamp. Otherwise, the projector's performance may degrade.
- Make sure to handle the lamp carefully and correctly since it may explode if it is scratched or shocked.
- Do not remove screws unless specified.

## Replacing Lamp

This projector uses the following lamp.

Lamp type No. SX6/X600: RS-LP02  
SX60: RS-LP03



- Be sure to use the specified lamp.



- A lamp can be ordered from your dealer or Canon home page.

## Replacing the Lamp

- 1 Turn off the projector, disconnect the power plug from the AC outlet, and then let the projector stand for at least 1 hour.
- 2 Loosen a screw with a flathead screwdriver and remove the lamp cover.

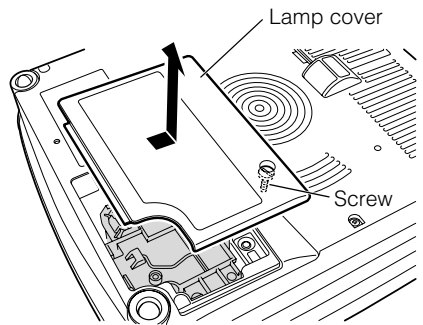

- 3 Loosen two screws, pull up the handle, and then remove the lamp.
- 4 Fully insert a new lamp and secure it with two screws.  
\* After the installation, be sure to push down the handle.

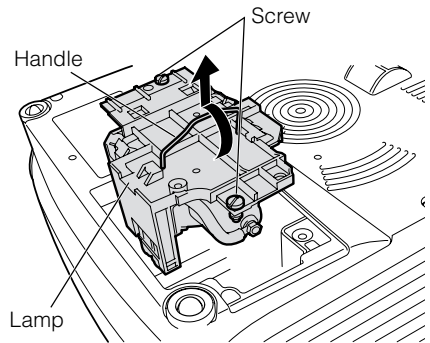

- 5 Replace the lamp cover and tighten the screw.
- 6 Turn on the projector.
- 7 Bring up the menu and select [System settings] -> [Other settings] -> [Lamp counter] (P102).
- 8 Select [Reset] -> [OK] to reset the lamp counter.

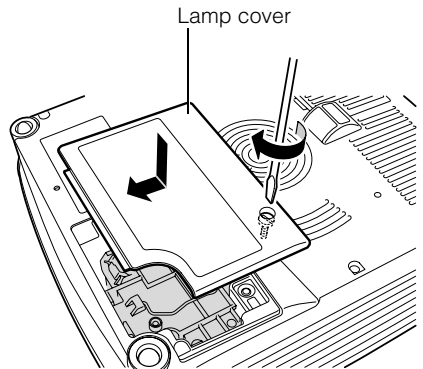



# TROUBLE- SHOOTING

Safety Instructions

Before Use

Setting Up the Projector

Projecting an Image from the Computer

Projecting an Image from AV Equipment

Useful Functions Available During a Presentation

Setting Up Functions from Menus

Maintenance

**Troubleshooting**

Appendix

Index

# Troubleshooting

## WARNING Lamp Flash Patterns

The WARNING lamp on the Control Panel flashes in red when there is a trouble in the projector.



- Turn off the projector, wait until the cooling fan stops, and remove the power plug from the AC outlet before dealing with the trouble.

Flash Pattern	Meaning	Countermeasure
One flash	Temperature abnormality	The temperature inside the projector is too high for some reason or the outside air temperature is higher than the specified one. If the problem is inside the projector, check whether the projector is installed and operated normally, turn off the projector to cool its inside, and retry projection. If the same warning occurs again, the projector may be defective. Contact your dealer.
Two flashes	Faulty lamp	The lamp has burnt out. Replace the lamp with a new one. If the same warning is experienced again, the lamp drive circuit may be defective. Contact your dealer.
Three flashes	Faulty lamp cover	The lamp cover is open. Check whether the lamp cover is installed correctly. If it is installed correctly, the lamp cover detection switch may be defective. Contact your dealer.
Four flashes	Faulty cooling fan	The cooling fan or another component may be defective. Contact your dealer.
Five flashes	Faulty power supply	The abnormal voltage is applied to some parts in the power supply or any other problem has occurred in the power supply. Contact your dealer.
Six flashes	System failure	Some of the functions may be defective. Turn off the projector and retry projection. If the same warning is experienced again, contact your dealer.



---

## Symptoms and Solutions

---

### You cannot turn on the projector.

Cause	Countermeasure
The power cord is not connected correctly.	Check whether the power cord is connected correctly (P35).
The power cord has just been connected.	You cannot turn on the projector until the [POWER] indicator turns red after connecting the power plug (P35).
You attempted to turn on the projector immediately after turning it off.	The projector cannot be turned on for a while after it is turned off. Wait for a while before pressing the [POWER] button again (P53).
The safety device has activated because you put the projector in the carrying bag during the cooling fan was rotating.	You cannot release the safety device. Contact your dealer.
The safety device is activated because the air intake or the exhaust vent is blocked and the internal temperature of the projector is increased.	You cannot release the safety device for safety reasons. Contact your dealer.

### You cannot project an image from the projector.

Cause	Countermeasure
Any connection cable is connected incorrectly.	Check whether the projector is connected to the computer or AV equipment correctly (P32, 56).
20 seconds have not passed since the projector was turned on.	When the projector is turned on, the Opening window is displayed for approximately 20 seconds. To project an image immediately, press the [OK] button on the remote control or top control (P35).
No image is sent from the AV equipment.	Check that an image is played on the connected digital camera, video camcorder, DVD, etc.
The wrong video terminal or signal type is selected.	Check that the correct video terminal and signal type are selected (P43, 61).
The [NO SHOW] function has been selected.	Press the [NO SHOW] button on the remote control (P66).
No image is sent due to the problem in the computer.	Turn on the projector and computer in this order again.

## You cannot hear sound.

Cause	Countermeasure
The audio cable is not connected correctly.	Check the cable connection of the audio cable (P34).
The [MUTE] function is enabled.	Press the [MUTE] button on the remote control (P66).
The volume level is adjusted to the minimum.	Press the [VOL+] button on the remote control or top control to adjust the volume level (P67).
An audio cable with a built-in resistor is used.	Use an audio cable without a built-in resistor.

## The projected image is blur.

Cause	Countermeasure
The image is out of focus.	Adjust the focus (P46).
The lens cap is not removed.	Remove the lens cap.
The distance to the screen is too short.	Check whether the distance to the screen is appropriate. If the distance is shorter than approximately 1.2 m (3.9'), the projector cannot focus on the screen (P28, 119).
The projector is not placed straight in front of the screen.	Check whether the projector is placed obliquely to the screen. A slight error in the projection angle can be corrected through the keystone adjustment function (P38, 47).
The projector has been moved to a place where the temperature varies a lot.	When the projector is moved from a low-temperature place to a high-temperature place, condensation may form on the lens. The condensation will evaporate a while later and the projector will be able to project a normal image.
The lens is stained.	Clean up the lens (P106).

## You cannot project an image appropriately.

Cause	Countermeasure
The projected image is inverted in the vertical or horizontal direction.	The ceiling mounted/rear projection setting is incorrect. Check the [Image flip H/V] setting in the [Display settings] menu (P85).

## You cannot project an image from a notebook computer.

Cause	Countermeasure
The connection cable is not connected correctly.	Check whether the connection cable is connected to the video terminal of the computer correctly (P32, 33).
The video signal type is incorrect.	Check whether the selected signal type is correct (P78, 79, 118).
It is not set the external monitor output setting on the notebook correctly.	Turn on the external monitor output on the notebook computer. To turn on the external monitor output, press the [LCD] or [VGA] function key or a key with an icon for the external monitor while holding down the [Fn] key on the keyboard of the notebook computer (P40). The combination of keys used to perform this operation varies among computer manufacturers. For more detailed information, refer to the User's Manual that came with your computer.
The displayed image is not the same as that displayed on the notebook computer.	Check whether the dual screen (multi-display) mode is selected on the notebook computer. If the dual screen mode has been selected, change it to the simultaneous display mode on the notebook computer. The output setting method varies among computer manufacturers. For more detailed information, refer to the User's Manual that came with your computer.

## The projector is forced to be turned off.

Cause	Countermeasure
The air intake or exhaust vent is blocked.	Check whether the air intake or exhaust vent is blocked. If the air intake or exhaust vent is blocked, the temperature inside the projector rises and the power is automatically turned off to protect the projector. Wait until the internal temperature gets down, and then turn on the projector without blocking the intake and exhaust vents (P21, 35).
The air filter is dirty.	Check whether the bottom air filter is clogged with dust. If the air filter is clogged, clean or replace the air filter (P107).
The lamp has exploded (or it is defective).	Check whether the lamp has exploded. If the lamp has exploded, replace it. The lamp may be defective if it has not exploded. Check the lamp by replacing it with a spare lamp if you have one (P12, 108, 109).
The operating temperature is inappropriate.	Check whether the operating temperature is 5 to 35°C (P13).
Other reasons	The projector may be damaged. Contact your dealer.

## You cannot operate the remote control.

Cause	Countermeasure
Batteries are not installed properly or they have run out.	Check whether batteries are installed correctly. If batteries are installed correctly, replace them with new batteries (P26).
You are operating the remote control from the outside of the remote control operating range.	Check whether you are operating the remote control within the remote control operating range. Also check whether there is any obstacle between the infrared remote receiver of the projector and the remote control (P26).
You are operating the remote control under an inappropriate operating environment.	Check whether the infrared remote receiver of the projector is exposed to direct sunlight or strong light of lighting apparatus (P26).
The channel setting of the remote control does not match with the setting of the projector.	Check whether the channel setting of the remote control has been changed. You can check the [Remote control] setting in the [System settings] menu (P100).
The key lock function is prohibiting the remote control operation.	Check whether [Key lock] is enabled to disable the remote control operation. In the System settings menu, set [Key lock] to [Off] (P98).

## You cannot use the wireless mouse function.

Cause	Countermeasure
The USB cable is not connected correctly.	Check whether the USB cable is connected between the projector and computer correctly (P70).
A mouse driver is not installed.	Check whether the mouse is functioning on the computer. If it is not, install a mouse driver to the computer.
The mouse is not recognized due to a problem in the computer.	Turn on the projector and computer in this order again.

# APPENDIX

Safety Instructions

Before Use

Setting Up the Projector

Projecting an Image from the Computer

Projecting an Image from AV Equipment

Useful Functions Available During a Presentation

Setting Up Functions from Menus

Maintenance

Troubleshooting

Appendix

Index

# Appendix

## Supported Computer Signal Types

This projector supports following signal types.

If your computer or AV equipment is compatible with any one of these signal types, the projector's auto PC function select the input signal type to project an image appropriately.

### ANALOG PC

Signal type	Resolution (dots)	Horizontal frequency (KHz)	Vertical frequency (Hz)	
VGA	640 x 480	31.469	59.94	
		31.469	70.09	
		37.50	75.00	
		37.861	72.81	
		37.861	74.38	
		43.269	85.01	
SVGA	800 x 600	31.469	70.09	
		34.50	55.38	
		35.156	56.25	
		37.879	60.32	
		37.898	61.03	
		38.00	60.51	
		38.60	60.31	
		46.875	75.00	
		48.077	72.19	
		53.674	85.06	
XGA	1024 x 768	44.028	54.63	
		46.897	58.19	
		47.00	58.31	
		48.363	60.00	
		48.496	60.02	
		56.476	70.07	
		58.032	72.00	
		60.023	75.03	
		60.314	74.92	
		60.994	75.77	
		62.04	77.07	
		63.478	79.35	
		68.677	85.00	
		47.986	59.83	
		47.712	60.02	
		1152 x 864	64.196	70.39
		61.17	65.28	
		SXGA	1280 x 1024	61.846
71.399	75.64			
60.00	60.00			
62.50	58.63			
63.337	59.98			
63.364	59.95			
63.735	60.01			
63.791	60.18			
63.899	60.00			
63.981	60.02			
WXGA	1280x768	47.986	59.83	
	1360x768	47.712	60.02	
SXGA+	1400 x 1050	63.981	60.02	
UXGA	1600 x 1200	75.00	60.00	
MAC LC 13	640 x 480	34.967	66.60	
MAC 13	640 x 480	35.00	66.67	
MAC 16	832 x 624	49.725	74.55	
MAC 19	1024 x 768	60.248	75.08	
MAC 21	1152 x 870	68.681	75.06	
MAC	1280 x 960	75.00	75.08	
MAC	1280 x 1024	80.00	75.08	

### DIGITAL PC

Signal type	Resolution (dots)	Horizontal frequency (KHz)	Vertical frequency (Hz)
D-VGA	640 x 480	31.469	59.94
D-SVGA	800 x 600	37.879	60.32
D-XGA	1024 x 768	48.363	60.00
D-SXGA*	1280 x 1024	63.981	60.02
D-SXGA+*	1400 x 1050	63.981	60.02

\* Only for SX6/SX60

### DIGITAL VIDEO

Signal type	Horizontal frequency (KHz)	Vertical frequency (Hz)
D-480p	31.469	59.94
D-575p	31.250	50.00
D-720p	44.955	59.94
D-1080i**	28.125	50.00
D-1080i**	33.716	59.94

\*\* Interlaced signal

### COMPONENT

Signal type	Horizontal frequency (KHz)	Vertical frequency (Hz)
480p	31.469	59.94
480i**	15.734	59.94
575p	31.250	50.00
575i**	15.625	50.00
720p	44.955	59.94
1035i**	33.750	60.00
1080i**	28.125	50.00
	33.716	59.94

\*\* Interlaced signal

- The specifications in the table above are subject to change without prior notice.
- This projector does not support any computer signal of which dot clock is 170MHz or higher.

## Relationship between Screen Size and Projecting Distance

Screen size at 4:3 aspect ratio Type – W x D (cm)	Projecting distance at (m)		H1 (cm)	H2 (cm)	Screen size at 16:9 aspect ratio Type – W x D (cm)
	Max. zooming	Min. zooming			
40" 81 x 61	1.2 (3.9')	2.0 (6.6')	55 (1.8')	6 (0.2')	37" 81 x 46
50" 102 x 76	1.5 (4.9')	2.5 (8.2')	69 (2.3')	8 (0.26')	46" 102 x 57
60" 122 x 91	1.8 (5.9')	2.9 (9.6')	82 (2.7')	9 (0.3')	55" 122 x 69
70" 142 x 107	2.1 (6.9')	3.4 (11.2')	96 (3.1')	11 (0.36')	64" 142 x 80
80" 163 x 122	2.4 (7.9')	3.9 (12.9')	110 (3.6')	12 (0.4')	74" 163 x 91
90" 183 x 137	2.7 (8.9')	4.4 (14.6')	123 (4.0')	14 (0.46')	83" 183 x 103
100" 203 x 152	3.0 (9.8')	4.9 (16.1')	137 (4.5')	15 (0.49')	91" 203 x 114
110" 224 x 168	3.3 (10.8')	5.4 (17.7')	151 (5.0')	17 (0.5')	101" 224 x 126
120" 244 x 183	3.6 (11.8')	5.9 (19.4')	165 (5.4')	18 (0.59')	110" 244 x 137
130" 264 x 198	3.9 (12.8')	6.4 (21')	178 (5.8')	20 (0.66')	119" 264 x 149
140" 284 x 213	4.2 (13.8')	6.9 (22.6')	192 (6.3')	21 (0.69')	128" 284 x 160
150" 305 x 229	4.5 (14.8')	7.4 (24.2')	206 (6.8')	23 (0.75')	138" 305 x 171
160" 325 x 244	4.8 (15.5')	7.9 (25.9')	219 (7.2')	24 (0.79')	147" 325 x 183
170" 345 x 259	5.1 (16.8')	8.4 (27.4')	233 (7.6')	26 (0.85')	156" 345 x 194
180" 366 x 274	5.4 (17.7')	8.9 (29.2')	247 (8.1')	27 (0.86')	165" 366 x 206
182" 370 x 277	5.4 (17.7')	9.0 (29.5')	250 (8.2')	28 (0.9')	167" 370 x 208
190" 386 x 290	5.6 (18.4')	–	261 (8.6')	29 (0.95')	174" 386 x 217
200" 406 x 305	5.9 (19.4')	–	274 (9.0')	30 (0.98')	184" 406 x 229
210" 427 x 320	6.2 (20.3')	–	288 (9.4')	32 (1.05')	193" 427 x 240
220" 447 x 335	6.5 (21.3')	–	302 (9.9')	34 (1.12')	202" 447 x 251
230" 467 x 351	6.8 (22.3')	–	315 (10.3')	35 (1.15')	211" 467 x 263
240" 488 x 366	7.1 (23.3')	–	329 (10.8')	37 (1.21')	220" 488 x 274
250" 508 x 381	7.4 (24.3')	–	343 (11.3')	38 (1.25')	233" 508 x 286
260" 528 x 396	7.7 (25.3')	–	357 (11.7')	40 (1.31')	239" 528 x 297
270" 549 x 411	8.0 (26.3')	–	370 (12.1')	41 (1.35')	248" 549 x 309
280" 569 x 427	8.3 (27.2')	–	384 (12.6')	43 (1.41')	257" 569 x 320
290" 589 x 442	8.6 (28.2')	–	398 (13.1')	44 (1.44')	266" 589 x 331
300" 610 x 457	8.9 (29.2')	–	411 (13.5')	46 (1.51')	276" 610 x 343

---

## Glossary

### 6-axis Color Adjustment (P94)

The color adjustment function for an advanced user. You can adjust color balance and color level for 6 axis of RGB (red/green/blue) and CMY (cyan/magenta/yellow) of the projected image to make a fine color adjustment. You can perform the 6-axis color adjustment in the image adjustment menu.

### AdobeRGB (P50, 89)

A color space specification set up by Adobe systems Incorporated which is applied to high performance digital cameras, displays and others. You can project an image with more accurate color reproduction since its has wider color gamut than sRGB. In SX6, if you select [AdobeRGB] in the [Image mode] setting, the projector can project the best-quality image conforming to the AdobeRGB Standard. Please be aware that color of the projected image may vary with that of the original image if you project an AdobeRGB compatible image in sRGB mode or project an sRGB compatible image in AdobeRGB mode.

### Analog PC (P25, 32, 81)

A signal system used to send analog signal information of R (red), G (green), and B (blue). It is a typical system for connecting a color monitor to a computer. Connect the analog PC output terminal on the computer and Input Terminal-1 or Input Terminal-2 on this projector with a monitor cable. Select [ANALOG PC-1] for Input Terminal-1 and [ANALOG PC-2] for Input Terminal-2 at projection.

### Component (P25, 56, 80)

A signal system used to send a color signal (C) with it divided into a B-Y color difference signal and an R-Y color difference signal. This system can project a better-quality image as compared with the composite signal system. Connect the component video terminal on the AV equipment and the Input Terminal-2 on this projector with a component cable. Select [COMPONENT] at projection.

### Composite (P25, 58)

A video signal system used to send a brightness signal (Y) and a color signal (C) together. Connect the composite output (RCA) terminal on the AV equipment and the VIDEO IN terminal on this projector with a video cable. Select [VIDEO] at projection.

### Digital PC (P25, 33)

A signal system used to send digital information of individual display dots. This system is free from deterioration of image quality because of no analog conversion. Connect the DVI output terminal on the computer and Input Terminal-1 on this projector with a DVI connection cable. Select [DIGITAL PC] at projection.

### DVI (P33, 43, 57, 61)

A digital video signal connection interface for a computer and AV equipment. This interface allows digital data to be transmitted without converting to analog data, assuring high image quality with no signal degradation. The DVI-I (integrated) connector can be used to transmit both an analog video signal and digital video signal.



### Gamma Correction (P91, 93)

A tone adjustment system used during projection of image data. The gamma correction function works effectively when portions of an image are obscure because they are too light or dark.

This projector supports manual gamma correction and dynamic gamma correction which performs the gamma correction automatically.

### HDCP (P57, 61)

An abbreviation of High-bandwidth Digital Content Protection which is an encryption technology for copy protection of digital image signals. In SX6/SX60/X600, you can project digital contents copy-protected with the HDCP technology. To project the contents, connect the Input Terminal-1 on the projector and an HDMI terminal or DVI terminal on an AV equipment with a dedicated cable, and then select [DIGITAL VIDEO] from the [INPUT] menu.

### HDMI (P57, 61)

A digital video signal connection interface for an AV equipment. Its terminal is more compact than the DVI terminal. It allows to transmit video and audio signals simultaneously.

### Memorized Color Correction (P93)

A memorized color is a color in our memory. The memorized color such as blue for the sky is more vivid than the real color, so you may feel colors of a projected image are dull. If such is the case, enable the memorized color correction function to make the colors close to the ones in our memory. You can enable the memorized color correction function in the image adjustment menu.

### Progressive (P84)

An image display system used to display the entire screen per scan. For an interlace signal (video signal) that displays one screen by two scans (one for odd lines and one for even lines) is input, progressive processing is required. When the progressive function is turned off, one screen is displayed using image signals per interlace signal, deteriorating the vertical resolution of the image. When the progressive function is turned on, one screen is displayed using image signals per two interlace signals, improving the vertical resolution of the image. Turn off the progressive function when flickering and horizontal lines are noticeable on a fast-moving picture.

### Resolution (P39, 79)

The number of dots (horizontal dots x vertical dots) that can be displayed on a computer is called "resolution of display". Resolution indicates the size of the display area (amount of information).

Resolution	Number of dots	
	Horizontal	Vertical
VGA	640	480
SVGA	800	600
XGA	1024	768
SXGA	1280	1024
SXGA+	1400	1050
UXGA	1600	1200

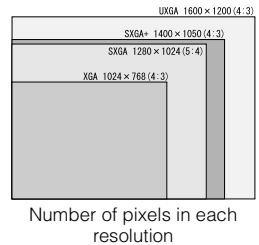

If you select SXGA+ (1400 dots x 1050 dots) as the display resolution for the connecting computer, this projector can project high-resolution images. If your computer does not have the SXGA+ option, select the maximum resolution among the selectable options.

### sRGB (P50, 89)

An international standard of color representation (color space) which is applied to general digital cameras, displays and others. In SX6/SX60/X600, if you select [sRGB] in the [Image mode] setting, the projector can project the best-quality image conforming to the sRGB Standard.

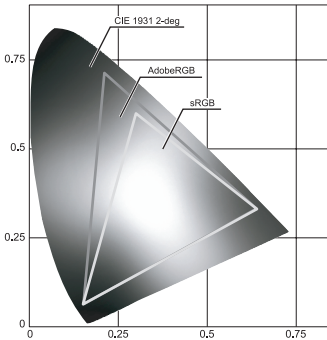

### S-video (P25, 57, 80)

A signal system (YC separation signal) used to send a brightness signal (Y) and color signal (C) separately. Connect the S-video terminal on the AV equipment and the S-VIDEO IN terminal on this projector with an S-video cable. Select [S-VIDEO] at projection.

### Video (P25, 58, 80)

An output terminal widely used in an AV equipment. It is also called as a composite output terminal (pin terminal or RCA terminal). For more details, refer to "Composite".

# Specifications

## Projector

Model name		SX6/SX60/X600
Display system		RGB liquid crystal system
Optical system		Color separation by dichroic mirror/polarizing beam splitter and color composition by prism
Display device	Type	Reflective liquid crystal panel
	Size/Aspect rat	0.7" x 3 panels/4 : 3
	Drive system	active matrix system
	Number of pixels/ Total Number of pixels	SX6/SX60: 1,470,000 (1400 x 1050) x 3 panels/4,410,000 X600: 786,432 (1024 x 768) x 3 panels/2,359,296
Projection lens	Zoom ratio/Focal length/F value	1.7x/f=21.7 to 35.8 mm/F1.85 to F2.5
	Zooming and focusing system	Electronic operation/electronic operation (with auto focusing function)
Lens shift		9 : 1 (fixed)
Light source		SX6/X600: 270W high-pressure lamp, SX60: 180W high-pressure lamp
Screen size (projection distance)		40" to 300" (1.2 to 9 m)
Number of reproducible colors		16,770,000 colors (full color)
Brightness		SX6/X600: 3500 lm, SX60: 2500 lm
Contrast ratio		1000:1 (full white : full black)/2000:1 (SX60 in Home Cinema mode)
Uniformity		88%
Speaker		1W monaural x 1
Maximum input resolution		1600 x 1200 dots (compression)
Video signals	ANALOG PC input	UXGA/SXGA+/WXGA/SXGA/XGA/SVGA/VGA (scan rate: horizontal: 15 to 100KHz, vertical 50 to 100Hz)
	DIGITAL PC input	SX6/SX60: SXGA+/SXGA/XGA/SVGA/VGA, X600: XGA/SVGA/VGA
	COMPONENT input	1080i, 1035i, 720p, 575i, 575p, 480i, 480p
	RGB SCART input	575i
	DIGITAL VIDED input	1080i, 720p, 575p, 480p
	VIDEO/S-VIDEO input	NTSC, PAL, SECAM, NTSC4.43, PAL-M, PAL-N
Input terminals	Input Terminal-1	Digital PC, analog PC, digital video (DVI-I connector 29-pin)
	Input Terminal-2	Analog PC, component, SCART (mini D-sub 15-pin)
	VIDEO IN terminal	composite (RCA)
	S-VIDEO IN terminal	S-Video (mini DIN 4-pin)
	AUDIO IN terminal	Audio signal (stereo mini jack)
	USB terminal	For mouse control (USB type B)
	SERVICE PORT	RS-232C (mini DIN 8-pin)
Output terminal		Analog PC (mini D-sub 15-pin)
Input signals	Digital PC	TMDS (Transition Minimized Differential Signaling)
	Analog PC	0.7Vp-p, positive polarity, impedance = 75Ω Horizontal/vertical synchronization: TTL level, negative or positive polarity Composite synchronization in G signal: 0.3Vp-p, negative polarity, impedance = 75Ω
	Video	Video:1Vp-p, negative synchronization, impedance = 75Ω S-video: Separate YC signal, Y: 1Vp-p, negative synchronization, impedance = 75Ω C: 0.286Vp-p (burst signal), impedance = 75Ω Component: Separate Y Cb/Pb Cr/Pr signal Y: 1Vp-p, Negative synchronization, impedance = 75Ω Cb/Pb: 0.7Vp-p, impedance = 75Ω Cr/Pr: 0.7Vp-p, impedance = 75Ω
	Audio	142mVrms, impedance = 47 KΩ or more
Noise (normal mode/silent mode)		SX6/X600: 35/31 db, SX60: 30/27 db
Operating temperature		5 °C to 35 °C
Power supply		AC 100 – 240 V, 50/60 Hz
Power consumption (normal mode/silent mode/standby)		SX6/X600: 355W/290W/7W, SX60: 250W/225W/7W
Dimensions		266 (W) x 114 (H) x 336 (D) mm / 10.6 (W) x 4.6 (H) x 13.4 (D) in (excluding protrusions)
Weight		SX6/X600: 4.7 kg/10.4 lbs, SX60: 4.6 kg/10.1 lbs
Accessories		Remote control, batteries for remote control, power cord, computer connection cable, USB cable, component cable, carrying bag, lens cover, string for lens cover, User's Manual, Quick Start Guide, and Warranty Card.

\* 99.99% or more of the LCD panel pixels are effective. During projection, 0.01% or less of pixels may stay lit or unlit due to the characteristics of the LCD panel.

\* Using the projector continuously for an extended period of time may accelerate the deterioration of optical parts.

## Remote Control

Power supply	Two 3.0 V, AAA-size batteries
Operating range	About 5 m (16.4') (to infrared remote receiver)
Dimensions	42 (W) x 22 (H) x 135 (D) mm / 1.7 (W) x 0.9 (H) x 5.3 (D) in
Weight (not including batteries)	55 g

## External View

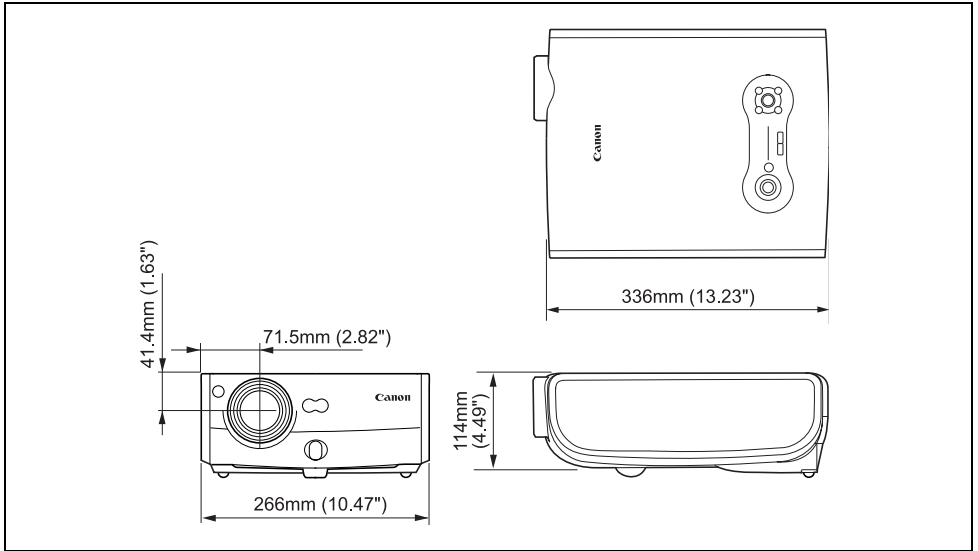

### Input terminal-2 (ANALOG IN-2) (Analog PC-2 input/component input terminal)

This terminal is used as a computer analog PC input or component input terminal. Use a D-sub computer cable for connection.

### Mini D-sub 15-pin

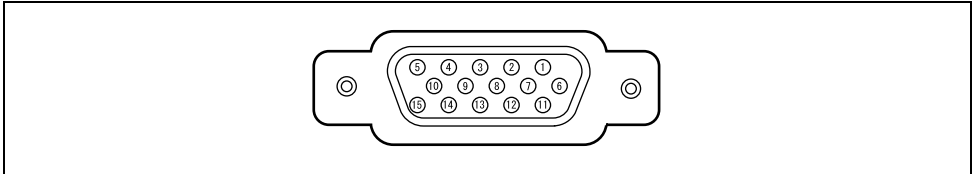

1	R	6	Ground (R)	11	Monitor ID0
2	G	7	Ground (G)	12	DDC data
3	B	8	Ground (B)	13	Horizontal sync.
4	Monitor ID2	9	+5 V power	14	Vertical sync.
5	Ground (Horizontal sync.)	10	Ground (Vertical sync.)	15	DDC clock



- The terminal specifications for the analog PC-2 input and component input are the same.

# Index

## Numerics

6-axis color adjust ..... 94

## A

Air filter ..... 107

Aspect ..... 52, 64, 78

AUDIO IN terminal ..... 34

Auto focus ..... 41, 60, 96

Auto input ..... 41, 60, 96

Auto keystone ..... 41, 60, 96

AUTO PC ..... 49

Auto screen color ..... 41, 60, 96

AUTO SET ..... 41, 60

Auto setup ..... 41, 60, 96

## B

Beep ..... 97

Brightness ..... 90

## C

Carrying bag ..... 12, 19

Ceiling mounted ..... 29, 85

Channel setting ..... 100

Color adjustment ..... 92

Contrast ..... 90

Cooling fan ..... 53

## D

D.ZOOM ..... 69

Digital video ..... 101

Direct power on ..... 97

Display settings menu ..... 74, 78

Dynamic gamma ..... 93

## E

External monitor ..... 34

## F

Factory defaults ..... 95, 103

Focus ..... 46

Focusing ..... 46

FREEZE ..... 67

## G

Gamma ..... 91

Guide ..... 99

## H

Horizontal pixels ..... 83

Horizontal position ..... 82

## I

IMAGE ..... 50

Image adjustment menu ..... 74, 89

Image flip H/V ..... 85

Image mode ..... 89

Image mode (quality) ..... 50, 89

INPUT ..... 43, 61

Input signal (AV equipment) ..... 61

Input signal (computer) ..... 43

Input signal select ..... 79

Input terminal ..... 25

Input terminal (for AV equipment) ..... 56

Input terminal (for computer) ..... 32

## K

Key lock ..... 98

Keystone ..... 47

Keystone distortion ..... 47

## L

Lamp ..... 12

Lamp counter ..... 102

Lamp mode ..... 94

Lamp replacement ..... 102, 108

Language ..... 36, 98

LED illumination ..... 100

Lens cap ..... 19

Logo capture ..... 86

Logo position ..... 87

## M

Mem. color correct ..... 93

Menu ..... 74

Menu position ..... 84

Mouse operation ..... 70

MUTE ..... 66

## N

NO SHOW ..... 66, 88

No signal screen ..... 87

## O

Output resolution ..... 39

## P

PAGE ..... 71

Page Up/Down ..... 71

Password settings ..... 101

POWER indicator ..... 24

Power management .....	54
Power management mode .....	54, 96
Progressive .....	84
Projection distance .....	28, 119
Projector installation .....	13, 29
Projector on .....	88
P-TIMER .....	68

## R

Rear projection .....	29, 85
Register password .....	102
Remote control .....	22, 26, 100
Reset .....	95
Resolution .....	52

## S

Screen color .....	86
Screen mode .....	52, 64
Screen size .....	119
Sharpness .....	91
Signal type .....	118
SPOT .....	68
Spotlight .....	68
Switching to external monitor .....	40
System settings menu .....	74, 96

## T

Top control .....	23
Total dots .....	81
Tracking .....	81

## V

Vertical pixels .....	83
Vertical position .....	82
VOL .....	67
Volume adjustment .....	67

## W

WARNING lamp .....	24, 112
--------------------	---------

## Z

Zoom (image size) .....	37
Zooming .....	69

## Options

- |   |  |
|---|--|
| <ul style="list-style-type: none"><li>● Lamp Part No.<br/>SX6/X600: RS-LP02<br/>SX60: RS-LP03</li><li>● Ceiling mounting bracket Part No: RS-CL06</li><li>● Ceiling mounting pipe (360mm)<br/>Part No: RS-CL03*</li><li>● Ceiling mounting pipe (550mm)<br/>Part No: RS-CL04*</li></ul> | <ul style="list-style-type: none"><li>● Ceiling mounting pipe (760mm)<br/>Part No: RS-CL05*</li><li>● Ceiling-mounting plate Part No: RS-CL02**</li><li>● DVI digital cable Part No: LV-CA29</li><li>● SCART cable Part No: LV-CA31</li><li>● Network adapter Part No: RS-NA01</li></ul> |
|---|--|

\* This part is used to hang the projector from a ceiling.

\*\* This part is used to join the ceiling pipe with the ceiling mounting bracket.

For more detailed information, refer to the instruction manual that comes with the ceiling mounting bracket RS-CL06.

# Menu Configuration

## The Display settings menu

Aspect	<b>DIGITAL PC/ANALOG PC</b> P78
	Full screen *
	Auto
	Wide Screen
	True size
	<b>VIDEO/S-VIDEO/SCART</b> P79
	Full screen *
	Wide Screen
	<b>DIGITAL VIDEO/COMPONENT</b> P78
	Auto *
	Full screen
	Wide Screen
Input signal select	<b>ANALOG PC</b> P79
	640 x 350
	:
	1680 x 1050
	<b>VIDEO/S-VIDEO</b> P80
	Auto *
	NTSC
	PAL
	SECAM
	NTSC4.43
	PAL-M
	PAL-N
	<b>COMPONENT</b> P80
	Auto *
	1080i
	1035i
	720p
	575p
	480p
	575i
	480i
	<b>SCART</b> P80
	575i
Input signal settings	<b>ANALOG PC</b>
	Total dots P81
	Tracking P81
	Horizontal position P82
	Vertical position P82
	Horizontal pixels P83
	Vertical pixels P83
Progressive	<b>COMPONENT/VIDEO/S-VIDEO</b> P84
	Off
	On
	Auto *

Menu position	P84
Screen color	Normal * P86
	Greenboard
	Adjust Red/Green/Blue
Image flip H/V	None * P85
	Ceiling mounted
	Rear
	Rear, Ceiling mounted
User screen settings	
Logo capture	OK/Cancel P86
Logo position	Upper L P87
	Upper R
	Center *
	Lower L
	Lower R
No signal screen	Black P87
	Blue *
	User logo
NO SHOW	Black * P88
	Blue
	User logo
Projector on	Canon logo * P88
	Skip
	User logo
Return	

\* : Factory defaults (settings after reset)



## The Image adjustment menu

Image mode	Standard *	P89
	Presentation	
	Movie (SX60/X600)	
	Movie&Photo (SX6)	
	AdobeRGB (SX6)	
	Home Cinema (SX60)	
	sRGB	
Brightness	P90	
Contrast	P90	
Sharpness	P91	
Gamma	P91	
Color adjustment	VIDEO/S-VIDEO/ COMPONENT	P92
	Color level	
	Color balance	
	COMMON	P92
	R Gain	
	R Offset	
	G Gain	
	G Offset	
	B Gain	
	B Offset	
Advanced adjustment		
Dynamic gamma	Off *	P93
	On	
Mem. color correct	Off *	P93
	L	
	M	
	H	
6-axis color adjust	Off *	P94
	Adjust   Hue/Saturation	
Return		
Lamp mode	Normal	P94
	Quiet	
Reset	OK/Cancel	P95

## The System settings menu

Auto setup	P96
Auto focus	Off
	On *
Auto keystone	Off
	On *
Auto input	Off
	On *
Auto screen color	Off *
	On
Return	
Power management mode	Off *
	Standby
	Exit
Direct power on	Off *
	On
Beep	Off
	On *
Key lock	Off *
	Main unit
	Remote control
Language	English   Turkish
	Germany   Polish
	French   Hungarian
	Italian   Czech
	Spanish   Danish
	Portuguese   Chinese
	Swedish   Chinese (Simplified)
	Russian   Chinese (Traditional)
	Dutch   Korean
	Finnish   Japanese
	Norwegian
Guide	Off
	On *
LED illumination	Off
	On *
Other settings	
Remote control	Ch1
	Ch2
Digital Video	F *
	L
Password settings	Off *
	On
Register password	Password input
Lamp counter	Return
	Reset (OK/Cancel)
Factory defaults	OK/Cancel
Return	

**CANON INC.**

30-2, Shimomaruko 3-chome, Ohta-ku,  
Tokyo 146-8501, Japan

**CANON U.S.A., INC.**

One Canon Plaza, Lake Success, NY 11042,  
U.S.A.

**CANON CANADA, INC.**

6390 Dixie Road Mississauga, Ontario L5T  
1P7 Canada

**CANON LATIN AMERICA, INC.**

703 Waterford Way Suite 400 Miami, Florida  
33126 U.S.A.

**CANON MEXICANA, S. de R.L. de C.V.**

Boulevard Manuel Avila Camacho, No. 138  
PB, Pisos 15, 16 y 17 Col. Lomas de  
Chapultepec, CP 11000, Mexico D.F., Mexico

**CANON EUROPA N.V.**

P.O.Box 2262, 1180 EG Amstelveen, The  
Netherlands

**CANON COMMUNICATION & IMAGE  
FRANCE S.A.**

102, Avenue du General de Gaulle, 92250 La  
Garenne Colombes, France

**CANON (UK) LTD.**

Woodhatch, Reigate, Surrey RH2 8BF,  
United Kingdom

**CANON DEUTSCHLAND GmbH**

Europark Fichtenhain A 10, 47807 Krefeld,  
Germany

**CANON ITALIA S.p.A.**

Palazzo L, Strada 6, 20089 Milanofiori-  
Rozzano (MI), Italy

**CANON (Schweiz) A.G.**

Industriestrasse 12, 8305 Dietlikon,  
Switzerland

**CANON BELGIUM N.V./S.A**

Bessenveldstraat 7, 1831 Diegem, Belgium

**CANON GmbH**

Zetschegasse 11, A-1232 Wien, Austria

**CANON ESPANA S.A.**

C/Joaquin Costa 41, 28002 Madrid, Spain

**CANON SVENSKA AB**

Stensättravägen 13, S-127 88 Skarholmen 2,  
Sweden

**CANON NORGE A/S**

Hallagerbakken 110, P. O. Box 2-33, Holmlia  
1201 Oslo 12, Norway

**CANON OY**

Huopalahdentie 24, P.O. Box 1, FIN-00351  
Helsinki, Finland

**CANON HONGKONG CO., LTD.**

19/F., The Metropolis Tower, 10 Metropolis  
Drive, Hungghom, Kln., H.K.

**CANON SINGAPORE PTE. LTD.**

1 HarbourFront Avenue #04-01, Keppel Bay  
Tower Singapore 098632

**CANON AUSTRALIA PTY. LTD.**

1 Thomas Holt Drive, North Ryde, Sydney,  
N.S.W.2113, Australia

**CANON NEW ZEALAND LTD.**

Akoranga Business Park, Akoranga Drive,  
Northcote, Auckland, New Zealand

**CANON DENMARK A/S**

Knud Hoejgaards Vej, DK-2860 Soeborg,  
Denmark



Y T 1 7 3 2 6 0 0 2