

## **Declaration of Conformity**

Hereby, Sharp Telecommunications of Europe Ltd, declares that this 902SH is in compliance with the essential requirements and other relevant provisions of Directive 1999/5/EC.

A copy of the original declaration of conformity can be found at the following Internet address:

<http://www.sharp-mobile.com>

Congratulations on your new 3G/UMTS 902SH phone.

### **Useful Functions and Services**

Your phone offers you the following features:

- *Video calls. You can talk while viewing each other on respective screens.*
- *A built-in digital camera for taking pictures and video clips.*
- *A message function for reading and creating SMS messages.*
- *MMS (Multimedia Messaging Services) for personalising your phone in various ways.*
- *A WAP browser for accessing information on the mobile Internet.*
- *Java™ applications. You can also download various applications from Vodafone via the mobile Internet.*
- *A voice recorder function for recording and playing back voice clips.*
- *A Bluetooth® wireless technology interface for establishing contact and transmitting data with certain devices. You can transmit pictures, sounds, and video clips to OBEX-enabled phones.*
- *An infrared interface for data communication. You can transmit pictures, sounds, and video clips to OBEX-enabled phones.*

## Introduction

---

- *A schedule alarm for creating and sending schedule entries with alarm settings.*
- *Video output. You can connect your phone to other devices, such as TVs or videos set to output, and display Java™ data, images, or video clips.*
- *Barcode scanner. With the built-in digital camera, you can read texts and barcodes, and create QR codes.*
- *Playback of the downloaded sound and video clip files.*
- *SD memory card slot that expands connectivity with a PC using the memory card.*

### **About This User Guide**

This user guide is carefully designed to help you learn about your phone's features and operations quickly and effectively.

### **NOTICE**

- *We strongly recommend that you keep separate permanent written records of all important data. Data may be lost or altered in virtually any electronic memory product under certain circumstances. Therefore, we assume no responsibility for data lost or otherwise rendered unusable, whether as a result of improper use, repairs, defects, battery replacement, use after the specified battery life has expired or any other cause.*
- *We assume no responsibility, directly or indirectly, for financial losses or claims from third parties resulting from the use of this product and any of its functions, such as stolen credit card numbers, the loss or alteration of stored data, etc.*
- *All company and/or product names are trademarks and/or registered trademarks of their respective holders.*
- *Screen layout may differ from that illustrated in this user guide.  
The information described in this user guide is subject to change without notice.*

## Introduction

---

- *All the functions described in this user guide may not be supported by all networks.*
- *We assume no responsibility for downloaded contents, information, etc. from the network.*
- *Occasionally, a few black or bright pixels may appear on the screen. Please note that this will not have any impact on any of the features or on performance.*

### Copyright

According to copyright laws, the reproduction, alteration and use of material which is protected by copyright (music, pictures, etc.) is only permitted for personal or private use. If the user is not in possession of more extensive copyright or has not received the explicit permission from the copyright owner to reproduce, alter or use a copy which has been made or modified in this way, this is considered to be a violation of the copyright laws and gives the copyright owner the right to claim for damages. For this reason, avoid the illegal use of material which is protected by copyright.

Windows is a registered trademark of Microsoft Corporation in the United States and/or other countries.

Powered by JBlend™ Copyright 1997-2004 Aplix Corporation. All rights reserved.  
JBlend and all JBlend-based trademarks and logos are trademarks or registered trademarks of Aplix Corporation in Japan and other countries.



Powered by Mascot Capsule®/Micro3D Edition™  
Mascot Capsule® is a registered trademark of HI Corporation  
©2002-2004 HI Corporation. All Rights Reserved.

Licensed by Inter Digital Technology Corporation under one or more of the following United States Patents and/or their domestic or foreign counterparts and other patents pending, including U.S. Patents: 4,675,863; 4,779,262; 4,785,450; 4,811,420; 5,228,056; 5,420,896; 5,799,010; 5,166,951; 5,179,571 & 5,345,467

## Introduction

---

T9 Text Input is licensed under one or more of the following: U.S. Pat. Nos. 5,818,437, 5,953,541, 5,187,480, 5,945,928, and 6,011,554; Australian Pat. No. 727539; Canadian Pat. No. 1,331,057; United Kingdom Pat. No. 2238414B; Hong Kong Standard Pat. No. HK0940329; Republic of Singapore Pat. No. 51383; Euro. Pat. No. 0 842 463 (96927260.8) DE/DK, FI, FR, IT, NL,PT,ES,SE,GB; Republic of Korea Pat. Nos. KR201211B1 and KR226206B1; and additional patents are pending worldwide.

SD logo  is a trademark.

Bluetooth is a trademark of the Bluetooth SIG, Inc.



The Bluetooth word mark and logos are owned by the Bluetooth SIG, Inc. and any use of such marks by Sharp is under license. Other trademarks and trade names are those of their respective owners.

Contains Macromedia® Flash™ technology by Macromedia, Inc.  
Copyright © 1995-2004 Macromedia, Inc. All rights reserved.  
Macromedia, Flash, Macromedia Flash, and Macromedia Flash Lite are  
trademarks or registered trademarks of Macromedia, Inc. in the United  
States and other countries.



Licensed by QUALCOMM Incorporated under one or more of the following  
United States Patents and/or their counterparts in other nations ;

4,901,307	5,490,165	5,056,109	5,504,773	5,101,501
5,506,865	5,109,390	5,511,073	5,228,054	5,535,239
5,267,261	5,544,196	5,267,262	5,568,483	5,337,338
5,600,754	5,414,796	5,657,420	5,416,797	5,659,569
5,710,784	5,778,338			



## Introduction

---



CP8 PATENT

This product is licensed under the MPEG-4 Visual Patent Portfolio License for the personal and non-commercial use of a consumer to (i) encode video in compliance with the MPEG-4 Video Standard ("MPEG-4 Video") and/or (ii) decode MPEG-4 Video that was encoded by a consumer engaged in a personal and non-commercial activity and/or was obtained from a licensed video provider. No license is granted or implied for any other use. Additional information may be obtained from MPEG LA. See <http://www.mpegla.com>.

This product is licensed under the MPEG-4 Systems Patent Portfolio License for encoding in compliance with the MPEG-4 Systems Standard, except that an additional license and payment of royalties are necessary for encoding in connection with (i) data stored or replicated in physical media which is paid for on a title by title basis and/or (ii) data which is paid for on a title by title basis and is transmitted to an end user for permanent storage and/or use. Such additional license may be obtained from MPEG LA, LLC. See <http://www.mpegla.com> for additional details.

# Contents

---

<b>Introduction .....</b>	<b>1</b>	<b>Using the Menu .....</b>	<b>51</b>
<b>Your Phone .....</b>	<b>13</b>	Top Menu .....	51
<b>Getting Started .....</b>	<b>14</b>	<b>Entering Characters .....</b>	<b>53</b>
Inserting the SIM Card and the Battery .....	20	Changing the Input Languages .....	55
Removing the SIM Card and the Battery .....	21	Changing the Input Mode .....	55
Charging the Battery .....	22	Using Templates .....	57
Inserting the Memory Card .....	25	<b>Contacts List .....</b>	<b>59</b>
Removing the Memory Card .....	26	Changing the Name Order .....	60
Turning Your Phone On and Off .....	26	Changing the List Displayed .....	60
Keypad Lock .....	28	Selecting the Storage Memory .....	61
Display Indicators (Main Display) .....	29	Changing the Contact List Order .....	61
Display Indicators (External Display) .....	32	Add New Contact .....	61
Opening Your Phone .....	33	Viewing My Contact Details .....	62
<b>Navigating Functions .....</b>	<b>34</b>	Copying Contacts List Entries between SIM Card and Handset .....	63
Using in the Normal Position of the Display .....	34	Finding a Name .....	63
<b>Voice Call/Video Call Functions .....</b>	<b>36</b>	Dialling from the Contacts List .....	63
Making a Voice Call .....	36	Editing Contacts List Entries .....	64
Speed Dialling .....	37	Deleting Contacts List Entries .....	64
Redialling .....	38	Manage Group .....	65
Answering a Voice Call .....	38	Assigning a Ringtone or a Ring Video Clip to Each Contacts List Entry .....	66
Incall Menu (Voice Call) .....	40	Memory Status .....	67
Making a Video Call .....	45	Speedial List .....	67
Answering a Video Call .....	46	Sending a Contacts List Entry .....	68
Incall Menu (Video Call) .....	47		

Receiving a Contacts List Entry .....	69	My Saved Page .....	138
<b>Camera .....</b>	<b>70</b>	Text Templates .....	139
Taking Pictures .....	70	Other Documents .....	140
Recording Video Clips .....	80	<b>Games &amp; More .....</b>	<b>143</b>
<b>Messages .....</b>	<b>87</b>	Games .....	143
MMS .....	87	Screensavers .....	145
SMS .....	87	Settings .....	146
Email .....	87	Java™ Information .....	148
Cell Broadcasts .....	98	<b>Organiser .....</b>	<b>149</b>
Area Info .....	100	Calendar .....	149
Setting Up MMS/SMS/Email .....	101	Alarms .....	153
<b>Vodafone live! .....</b>	<b>105</b>	Calculator .....	155
Starting the WAP Browser .....	106	Voice Recorder .....	157
Navigating a WAP Page .....	106	Scanner .....	158
<b>Media Player .....</b>	<b>110</b>	Stopwatch .....	162
Switching between Music Player and		Tasks .....	163
Video Player .....	110	World Clock .....	166
Music Player .....	110	Countdown Timer .....	167
Video Player .....	113	Expenses Memo .....	168
<b>My Items .....</b>	<b>117</b>	Phone Help .....	169
Pictures .....	118	<b>SIM Application .....</b>	<b>170</b>
Videos .....	124	<b>Settings .....</b>	<b>171</b>
Sounds & Ringtones .....	129	Profiles .....	171
Games & More .....	134	Setting the Display .....	178
Bookmarks .....	138	Sound Settings .....	185

## Contents

---











Time & Date .....	185	PRECAUTIONS CONCERNING VEHICLE USE .....	236
Language Setting .....	187	SAR .....	237
Call Settings .....	188	PRECAUTIONS FOR USE IN USA .....	238
Video Call Settings .....	195	<b>Specifications and Optional Accessories .....</b>	<b>242</b>
Security .....	197	Specifications .....	242
Memory Settings .....	200	Optional Accessories .....	242
Master Reset .....	201	<b>Index .....</b>	<b>243</b>
<b>Call Log .....</b>	<b>202</b>	<b>List of Menu Functions .....</b>	<b>248</b>
Call Timers .....	203		
Call Costs .....	204		
<b>Connectivity .....</b>	<b>206</b>		
Bluetooth .....	206		
Infrared .....	212		
Network Settings .....	213		
Internet Settings .....	216		
Backup/Restore .....	220		
<b>Connecting 902SH to Your PC .....</b>	<b>223</b>		
System Requirements .....	223		
3G/GSM GPRS Modem .....	224		
Handset Manager .....	225		
Software Installation .....	225		
<b>Troubleshooting .....</b>	<b>227</b>		
<b>Safety Precautions and Conditions of Use .....</b>	<b>229</b>		
CONDITIONS OF USE .....	229		
ENVIRONMENT .....	235		

Please check the following carefully. Your phone should come complete with:





- 3G (UMTS)/GSM 900/1800/1900/GPRS phone
- Lithium Ion Battery
- Battery Cover
- AC Charger
- Stereo Headset
- Handsfree Microphone Unit
- CD-ROM
- SD Memory Card
- Video Cable

## Getting Started

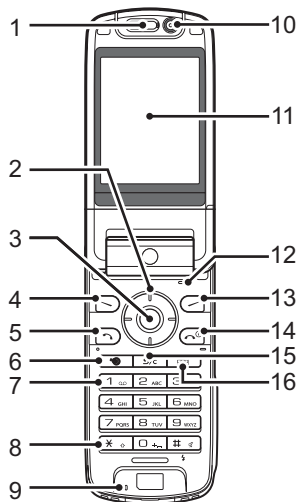
---

1. Earpiece
2. Navigation Keys (Arrow Keys):
  -     Moves cursor to highlight a menu item, etc.
  - Up/Down arrow keys: Displays the Contacts List when pressed during stand-by.
  - Left arrow key: Displays the message inbox when pressed during stand-by.
  - Right arrow key: Displays the monthly calendar when pressed during stand-by.
3. Centre Key:
  -  Displays Main menu when pressed during stand-by, then executes a function highlighted.
4. Left Soft Key:
  -  Executes a function at the bottom left of the screen. Press during stand-by to display the Messaging screen.
5. Send/Redial Key:
  -  Makes or accepts calls, displays the All Calls screen in stand-by mode.
6. Shortcut Key:
  -  Press to open the shortcut menu to access the desired applications.
7. Voice Mail Key:
  -  Press and hold to connect to the Voice mail centre automatically. (Depending on the SIM card.)
8. \* /Shift Key:
  -  Switches character case between four modes: Abc, ABC, 123 and abc on the text entry screen. Press to enter P, ?, – or \* in stand-by mode.



- 9. Microphone
- 10. Sub Camera (Internal Camera)
- 11. Main Display
- 12. Microphone (for the viewer style of the display)
- 13. Right Soft Key:  
 Executes the function at the bottom right of the screen. Shortcut to "Vodafone live!" by opening the browser. Press during stand-by.
- 14. End/Power Key:  
 Ends a call and turns power on/off.
- 15. Clear/Back Key:  
 Clears the characters before the cursor, returns to the previous screen, etc.
- 16. Multimedia Key:  
 Opens the Media Player screen.



## Getting Started

---

### 17. Keypad:

1 key:

Shortcut to the Voice mail centre. (Depending on the SIM card.) Press and hold during stand-by.

2-9 keys:

Press and hold during stand-by to display each speed dial phone number.

0 key:

Press and hold to enter +.

### 18. #/Flash Light Key:



Switches symbol screens on the text entry screen.

Press and hold to switch languages on the text entry screen.

Turns the flash/auxiliary light on or off in camera mode.

Press and hold during stand-by to switch Profiles settings between the mode most recently activated and Silent mode.

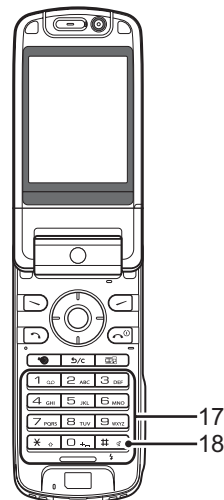

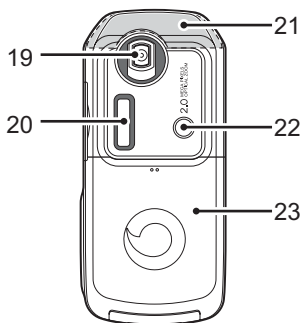

19. Camera (External Camera)

20. Sub Display

21. Built-in Aerial:

Warning: Do not cover the top of the phone with your hand when in use as this may interfere with the performance of the built-in aerial.

22. Mobile Light:

Used as a flash or an auxiliary light in camera mode.

23. Battery Cover

24. VIDEO OUT/Handsfree Microphone Connector

25. External Connector:

Used to connect either the charger or a USB data cable.

26. Stereo Speakers

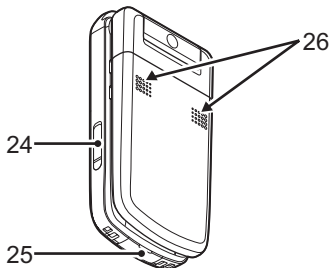

## Getting Started

---

27. Infrared Port: Sends and receives data via infrared.
28. Memory Card Slot Cover
29. Small Light: Used as a battery charge indicator.
30. Side Keys (Side–Up/Side–Down/Camera/Cancel):  
Side-Up/Side-Down: (These two keys work in reverse with the viewer position of the display.)  
Moves the highlight up or down.  
Press during stand-by or during a call to increase or decrease the earpiece volume.  
Press in camera mode to increase or decrease the zooming ratio.
- Camera Key: Displays the Main menu when pressed during stand-by, then executes a highlighted function. Press and hold to activate the camera.  
Press and hold to display the Options menu.  
Press during an incoming call to answer the call.  
Press during a call to display the Call options.  
Press halfway to lock the focus in camera mode.  
Press (and hold) to take a picture with the camera.

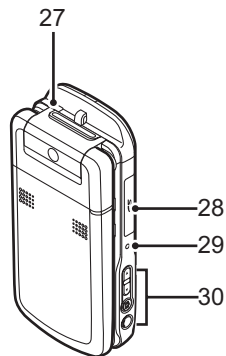

Cancel Key:

Press to return to the previous screen.

Press and hold to reject an incoming call.

Press during an incoming call to send a busy tone to the caller.

Press to end the call.

### Inserting the SIM Card and the Battery

1. Slide off the battery cover (① ②).
2. Slide the SIM card into the SIM holder.
3. Hold the battery so that the metal contacts of the battery are facing down, slide the guides on the top of the battery into the battery slots (③), and then insert it (④).
4. Replace the battery cover.

#### Note

- Make sure that only 3V SIM cards are used.
- Make sure that the standard accessory battery (XN-1BT90) is used.

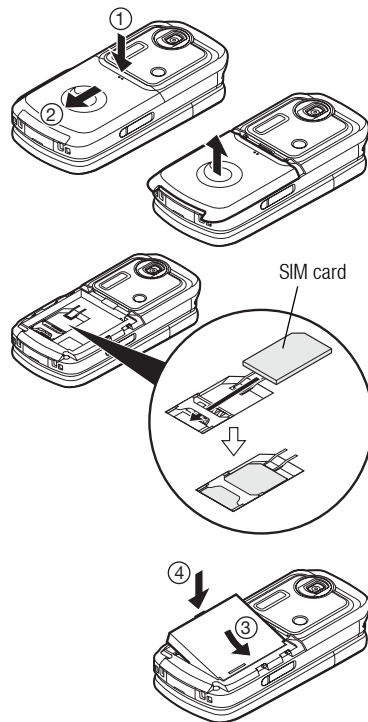

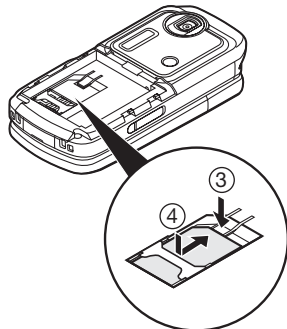
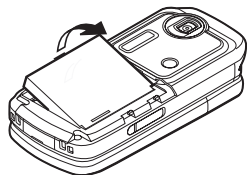
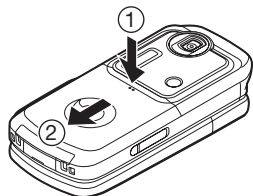

## Removing the SIM Card and the Battery

1. Ensure that the phone is turned off and that the charger and other accessories are disconnected. Slide off the battery cover (① ②).
2. Lift the battery using the protruding edge and remove the battery from the phone.
3. Hold ③ down gently while sliding the SIM card out of the SIM holder (④).

### Battery Disposal

The device is battery-powered. In order to protect the environment, please read the following points concerning battery disposal:

- Take the used battery to your local waste depot, dealer or customer service centre for recycling.
- Do not expose the used battery to a naked flame, immerse in water or dispose with the household waste.

### Charging the Battery

You must charge the battery for at least 135 minutes before using your phone for the first time.

#### Using the Charger

1. Open the cover of the external connector, connect the charger to the external socket located at the bottom of the phone by pressing both sides indicated with arrows, and connect to an AC outlet.

The small light turns red.

Standard charging time: Approx. 135 minutes

#### Note

- *Charging time may vary depending on the state of the battery and other conditions. (See "Battery" on page 231.)*

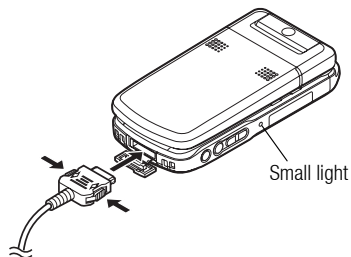

### To Disconnect the Charger

When charging is complete, the small light turns off.

1. Unplug the charger from the AC outlet, then unplug the charger connector from the phone.
2. Close the cover.

### **Note**

- Do not use any non–approved chargers as they may damage your phone and invalidate any warranties, see “Battery” on page 231 for details.
- When the phone is charging, the small light blinks and the animated battery status indicator () in the upper right of the screen displays the current status of the battery.

### To Charge Using the Cigarette Lighter Charger

The optional cigarette lighter charger supplies power for charging from the cigarette lighter socket of a car.

### Battery Level Indicator

The current battery level is displayed in the upper right of the main and the external displays.







## Getting Started

---

### Low Battery during Use

When the battery is running low, an alarm will sound and “” is displayed on the main and external displays.

If you are using your phone and you hear the low battery alarm, attach your charger as soon as possible. The phone may not be able to continue normal operation if you continue to use it.

Battery Indicators	Charge Level
	Sufficiently charged
	Charging recommended
	Charging required
	Empty

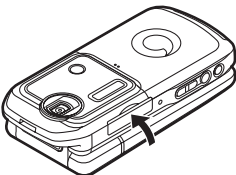
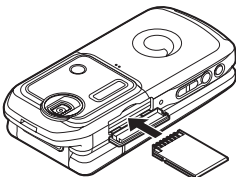
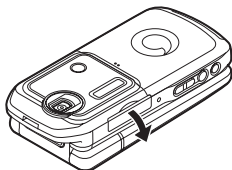

## Inserting the Memory Card

1. Turn off the phone.
2. Open the memory card slot cover.
3. Insert the memory card all the way in.
4. Close the cover.

### Note

- The miniSD memory card cannot be used with your phone.
- Make sure that the phone is turned off before inserting the memory card.
- Be sure to insert the card in the correct direction and orientation.
- The SD memory card has a write-protect switch that prevents you from deleting memory contents by accident. If you slide the switch to the lock position, you cannot save or delete files.
- Do not open the memory card cover while the memory card is being formatted or written to. The card may be damaged beyond use.
- Keep all memory cards out of the reach of small children.

## Getting Started

---

### Tip

- You see the following indicators when the memory card is in use:



: Appears when the card is inserted.



: Appears when the card is inserted and locked.



: Appears when the card is damaged or unusable.



: Appears when the card is locked and damaged or unusable.



: Appears when the card is being written or read.



: Appears when the card is being formatted.

## Removing the Memory Card

1. Open the memory card slot cover, remove the card, and close the cover.

### Note

- Make sure that the phone is turned off before removing the memory card.
- Do not remove the memory card while the memory card is being formatted or written to.

## Turning Your Phone On and Off

To turn the power on, press and hold  for approximately 2 seconds.

The stand-by screen is displayed.

### To Enter the PIN Code

If activated you are asked to enter a PIN (Personal Identification Number) code and handset lock code after turning on your phone.

1. Enter your PIN code.

The PIN code is 4 to 8 digits.

2. Press .

To turn the power off, press and hold  for approximately 2 seconds.

### Note

- If your PIN code is entered incorrectly three times in a row, the SIM card is locked. See “Enabling/Disabling the PIN Code” on page 197.
- If the clock settings have not been made, the date and time entry screen is displayed (p. 185).

### To Copy All Contacts List Entries from the SIM Card

When you insert the SIM card into your phone for the first time and start the Contacts List application, you are asked whether you wish to copy Contacts List entries on the SIM card. Follow the on-screen instructions, or you can do it later using the Contacts List menu as follows:

**“Contacts” → “Advanced” → “Copy All Entries”**

1. Select “SIM to Handset”.

## Getting Started

---

### Keypad Lock

You can lock the keypad to prevent it from being pressed accidentally.

#### Locking the Keypad

1. Press and hold  during stand-by.







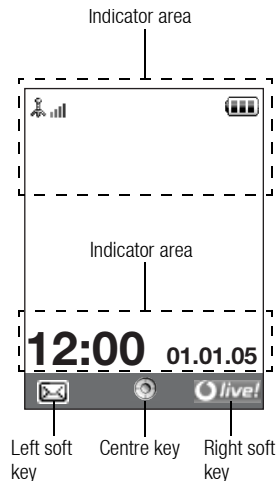













To unlock, press and hold .

#### **Tip**

- *Emergency numbers (112, etc.) can be entered and dialled regardless of the keypad lock.*





































## Display Indicators (Main Display)

1.   : Strength of received signal/Service out of range
  -  : 3G (UMTS)/GPRS
  -  : GSM/GPRS
  -  : Roaming outside network
2.  : Offline mode [enabled]
3.  : Data exchange with external device
4.   : Connection to the server [established/communicating]
5.  : Memory card inserted
6.   : Voice call [incoming/in progress]
7.    : Video call communication mode enabled
8.  : Diverts set to "Voice calls" of "All Calls"
9.  : Secure WAP page displayed
10.    : Alerts [text message/multimedia message/email]

## Getting Started

---

11.  /  /  /  :  
Connection status  
[USB cable/IrDA ON/IrDA exchanging information/*Bluetooth* wireless setting [enabled (during stand-by or except during stand-by)/exchanging information/talking with the Bluetooth headset]]
12.  /  : Java™ application [executed (colour)/suspended (grey)]
13. (No display) /  /  /  /  /  /  :  
Current profile [Normal/Meeting/Activity/Car/Headset/Silent]
14.  /  /  /  :  
Silent/vibration setting [silent/increasing volume/vibration enabled/silent and vibration enabled/increasing volume and vibration enabled]
15.  /  /  : Speaker mode [speaker phone/speaker activated/microphone muted]
16.  /  /  /  :  
Battery level [sufficiently charged/charging recommended/charging required/empty]
17.  : Mobile light enabled
18.  : Daily alarm enabled
19.  /  : Schedule entry enabled [with/without reminder alarm]
20.  : Outbox contains unsent messages [text message/multimedia/email]

21. : WAP/OTA provisioning alerts [WAP alert/OTA provisioning alert/WAP and OTA provisioning alerts]
22. : Voicemail message alert
23. : Connection status [1st IrDA communication [enabled/exchanging information]]
24. : Phone Lock enabled
25. : Keypad Lock enabled
26. /(blank): IrDA setting [enabled/disabled]
27. 12:00: Clock
28. 01.01.05: Date
29. (Operator name)
30. (Cell Broadcasts information)

### Soft Key Indicators

To execute the operation indicated, press the corresponding key.

31. Area at the lower left of the screen:  
Display the operation executed by the left soft key.
32. Area at the lower right of the screen:  
Display the operation executed by the right soft key.



### Display Indicators (External Display)

#### Status Indicators

1. Battery level [sufficiently charged/charging recommended/charging required/empty]
2. Clock
3. : Strength of received signal/Service out of range
4. : Missed events
5. : Voice call incoming
6. : Video call incoming
7. : Call in progress
8. : Alerts [messages/Delivery Report]
9. : WAP Push service
10. : Daily alarm enabled
11. : Sound file being played
12. : Offline mode
13. : Stopwatch/countdown timer
14. : OBEX data incoming
15. : Voice Recorder activated

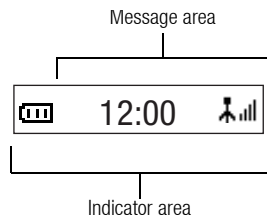

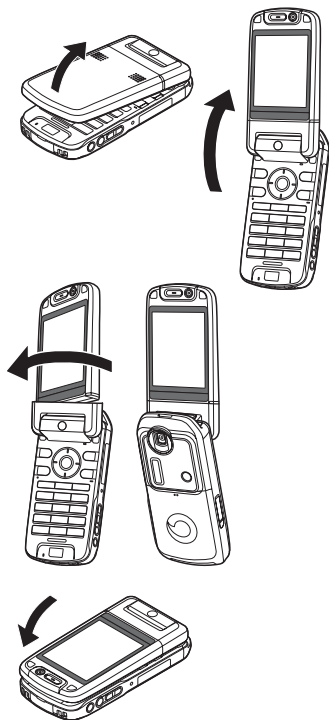

## Opening Your Phone

Your phone can be opened in the following three positions: normal, self-portrait and viewer positions.

### Normal Position

1. Open the phone until the display stops as illustrated.

### Self-portrait Position

2. Turn the display 180° clockwise.

Use this position to take a self-portrait position with the external camera.  
Do not turn the display anticlockwise as this may damage it.

### Viewer Position

3. Close the main display toward the keypad.

### Note

- Operations of the side-up and side-down keys are reversed in the viewer position of the display.
- Keypad operations cannot be performed in the viewer position of the display.
- Do not carry the phone in the viewer position of the display as this may damage the display.

## Navigating Functions

---

### Using in the Normal Position of the Display

All applications are accessed from the Main menu. To open the Main menu, press the centre key (○) during stand-by.

To launch applications, you will need to highlight menu items, and make selections. To select a menu item (indicated in quotation marks), move the cursor using ▲, ▼, ◀ and ▶, and press ○ to select.

In certain procedures, you will need to press one of the soft keys (indicated in square brackets), which are displayed at the bottom left and right of the screen. Press the corresponding soft key (⏪ or ⏩).

To return to the previous screen, press the right soft key if it displays *Back*. To close the Main menu, press the right soft key if it displays *Exit*.

Each section in this user guide starts with a list of items you will need to select in order (indicated in italics) before performing the procedures shown. Select each item to reveal the next set of items that you have to select. Open subsection items after opening those listed in the main section.

Example:

***“Contacts”*** → ***“Contacts List”*** → ***“Add New Contact”***

### Using in the Viewer Position of the Display

Available keys in viewer position of the display are the side-up and side-down keys, camera key and cancel key.

To open the Main menu, press the camera key during stand-by.

To select a menu item (indicated in quotation marks), press the side-up and side-down keys and press the camera key to select.

In certain procedures, you will need to press one of the soft keys (indicated in square brackets), which are displayed at the bottom left and right of the screen. The left soft key is the camera key and right soft key is the cancel key.

#### The side keys function in camera mode as follows:

Side-up/Side-down keys:      Zoom-in/Zoom-out

Camera key:                      Capture

Cancel key:                        Options



## Voice Call/Video Call Functions

---

### Tip

- You can make and answer a call in the viewer position of the display using the side keys.

### Making a Voice Call

1. Enter the area code and the phone number you wish to dial and press  to dial.  
If you enter the wrong number, press  to delete the number to the left of the cursor.

### Emergency Calls



1. Enter 112 or 911 (international emergency number) using the keypad and press  to dial.

### Note

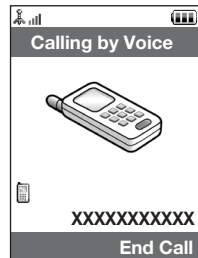
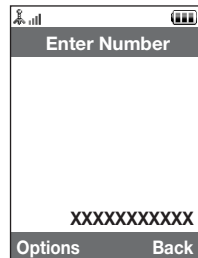
- Emergency calls may not be able to be made on all mobile phone networks when certain network services and/or phone features are in use. Contact your network operator for more information.
- This emergency number can normally be used to make an emergency call in any country, with or without a SIM card inserted, if a 3G (UMTS)/GSM network is within range.



### International Calls

1. Press and hold  until a + (international dialling prefix) sign is displayed.
2. Enter the country code, followed by the area code (without the leading zero) and the phone number, and press  to dial.



### Adding an Entered Phone Number to the Contacts List

1. After entering a phone number, press [Options] and select “Save Number”.  
For details on creating a new entry, see “Add New Contact” on page 61.



### Showing or Hiding My Phone Number on the Display of the Called Party

1. After entering a phone number, press [Options] and select “Hide My ID” or “Show My ID”.

### Speed Dialling

Up to 8 phone numbers from the Contacts List memory (Handset and SIM) can be assigned to speed dials. You can call the numbers using the digit keys ( to ). The phone number of the Voice mail centre is assigned to .

For details on setting the speeddial list, see “Speeddial List” on page 67.



1. To dial a number using the speed dial, press and hold any of the digit keys ( to  or ).

The phone number saved in the speeddial list is dialled.

### Redialling

You can redial numbers in the call log. Select from specific categories or “All Calls”. Specific categories contain up to 10 numbers and the “All Calls” list contains up to 30.

1. Press  during stand-by.
2. Select the category from “All Calls”, “Dialled Numbers”, “Missed Calls” or “Received Calls”.



To switch logs, press  or .

3. Highlight the phone number you wish to call.
4. Press  to redial the call.

### Answering a Voice Call

When an incoming call is detected, the phone rings.

1. Press  or [Answer] to answer the call.

Or press any key except , ,  and [Busy] when the “Any Key Answer” function is enabled. Set the Any Key Answer function in the profile of each mode (p. 177).

### **Tip**

- *If you have subscribed to the Calling Line Identification (CLI) service and the caller's network sends the number, the caller's number is displayed on the screen. If the caller's name and number are saved in the Contacts List, the caller's name and phone number are displayed on the screen.*
- *If the number is a restricted number, the display shows "Withheld".*
- *When you receive a call from the person whose picture is registered in the Contacts List, the picture, name and phone number are displayed.*

### **Rejecting an Incoming Call**

1. Press  while the phone is ringing to reject a call you do not wish to answer.

### **Letting the Caller Know You are Unavailable**

1. Press [Busy] while the phone is ringing to send a busy tone to the caller of an incoming call letting them know that you cannot answer the call.





### Incall Menu (Voice Call)

Your phone has additional functions available while a call is in progress.

#### Adjusting the Earpiece Volume

During a call, you can adjust the earpiece volume (and handsfree volume, if connected).

1. During a call, press the side–up or side–down key to display the Earpiece Volume screen.
2. Press the side–up key (or ) to increase the volume of the call or press the side–down key (or ) to decrease the volume.  
Five levels (level 1 to 5) can be selected.
3. Press  when the volume is set to the desired level.

The phone returns to the in-call screen automatically if left unoperated.

#### Turning the Speakers On and Off

You can talk via the loud speakers on the back of the phone by turning them on.

1. During a call, press [Options] and select “Loud Speaker On”.

### Putting a Call on Hold

This function allows you to manage two calls at the same time. If you wish to make another call while you are talking to someone, you can put the current call on hold to call someone else.

#### To Make Another Call during a Call

1. During a call, press [Options] and select “Hold”.

The current call is put on hold.

2. Press [Options] and select “Dial New Number”.
3. Enter the phone number you wish to make another call to, then press .

#### Tip

- You can also make another call by entering the phone number during a call instead of step 1. The current call is automatically put on hold.

### Accessing SMS/MMS Menu during a Call

1. During a call, press [Options] and select “Send Message”.

The following options are available: “Create New” to make an SMS and MMS, or “Inbox”, “Sent” or “Drafts” to access these folders. For details on SMS, see “SMS” and “MMS” on page 87.

## Voice Call/Video Call Functions

---

### Call Waiting

This service notifies you of another incoming call while you have a call in progress.

1. During a call, press [Options] and select “Hold & Answer” to answer the second call.  
The first call is put on hold and you can now talk to the second caller.
2. Press [Options] and select “Release & Answer” to end the current call and return to the held call.

### Note

- You need to set “Call Waiting” to “On” if you use the Call Waiting service (p. 190).
- Call Waiting service may not be available on all networks. Contact your network operator for more information.
- If you do not wish to answer the second call, press [Options] and select “Busy” in step 1. If “Reject” is selected, the log of the second call is saved as a missed call.

### Conference Call

Conference call is a call with more than 2 participants. You may include up to 5 participants in a conference call.

#### To Make a Conference Call

You must have one active call and one held call.

1. During a call, press [Options] and select “Multi Party”.
2. Select “Conference All” to join the conference call.
3. Press  to end the conference call.

### **Note**

- *The conference call service may not be available on all networks. Contact your network operator for more information.*
- *You have more options for the Conference call in step 2:*
  - *To put all participants on hold, select “Hold All”.*
  - *To put all participants except the current call on hold, select “Private”.*
  - *To end the call with all participants, select “End Active Call(s)” or “End Held Call(s)”.*
  - *To reject adding more participants to the current party, press [Options] and select “Reject”, or you can send the busy tone by selecting “Busy”.*

### To Add New Participants to the Conference Call

1. Press [Options] and select “Dial New Number”.
2. Enter the number you wish to include in the conference call and press  to dial.
3. Press [Options] and select “Multi Party”.
4. Select “Conference All” to join the conference call.

If you wish to add other participants, repeat steps 1 to 4.

### To End the Call with a Conference Call Participant

1. During a conference call, highlight the person that you wish to disconnect from the conference call.
2. Press [Options] and select “End Active Call(s)” or “End Held Call(s)”.

## Voice Call/Video Call Functions

---

### To Have a Private Conversation with One of the Participants

If you wish to have a private conversation with one of the participants, you may select the participant from the conference list and put the other participants on hold.

1. During a conference call, select the person that you wish to talk to.
2. Press [Options] and select “Multi Party”.
3. Select “Private”.
4. Once you have finished the private conversation, press [Options] and select “Multi Party”.
5. Select “Conference All” to return to the conference call.

### Muting the Microphone

1. During a call, press [Mute] to mute the microphone.  
To unmute the microphone, press [Unmute].

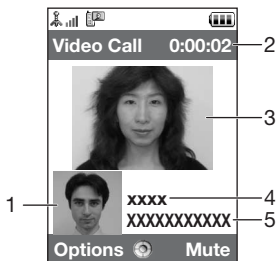

## Making a Video Call

### Note

- Use this function with only the video call enabled phones.
- Make sure that the battery is fully charged and the signal length is greater before using this function.
- Turn the loud speakers on or use a switch–equipped earphone microphone or handsfree kit so that you can talk while looking at the video call screen on the main display.

### Status Indicators

1. Sub screen for your image
2. Elapsed time (hour:minute:second)
3. Main screen for the calling party's screen
4. Calling party's name
5. Calling party's phone number

### Making a Video Call

1. Enter the area code and the phone number you wish to dial and press [Options] and select "Video Call" to dial.

If you enter the wrong number, press **[DEL]** to delete the number to the left of the cursor. When the line is connected, the image of the called party is displayed upper on the screen, and yours lower left.

## Voice Call/Video Call Functions



---

### Tip

- If the called party's phone is not video call enabled, you can press  and enter the phone number again to make a voice call.
- When the call ends, the last call cost is displayed.

## Answering a Video Call

When an incoming call is detected, the phone rings.

1. Press  to answer the call by video or  [Answer] to answer the voice only.

### Tip

- When the call is ended, the call cost is displayed.
- If you have subscribed to the Calling Line Identification (CLI) service and the caller's network sends the number, the caller's number is displayed on the screen. If the caller's name and number are saved in the Contacts List, the caller's name and phone number are displayed on the screen.

## Rejecting an Incoming Call

1. Press  while the phone is ringing to reject a call you do not wish to answer.

## Letting the Caller Know You are Unavailable

1. Press [Busy] while the phone is ringing to send a busy tone to the caller of an incoming call letting them know that you cannot answer the call.

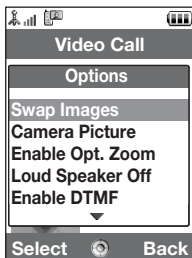

## Incall Menu (Video Call)

### Muting the Microphone

1. During a video call, press [Mute] to mute a microphone.  
To unmute the microphone, press [Unmute].

### Swapping Images

You can swap images between the main and sub screens.

1. During a video call, press [Options] and select “Swap Images”.

### Changing the Image of Yourself

1. During a video call, press [Options] and select “Camera Picture”.
2. Select from “Internal Camera”, “External Camera” or “Alternative Image”.

“Internal Camera”: The image through the internal camera is displayed and sent to the party.

“External Camera”: The image through the external camera is displayed and sent to the party.

“Alternative Image”: The camera is turned off and the image selected in “Alternative Image” of “Video Call Settings” (p. 195) is used.



## Voice Call/Video Call Functions

---

### Using the Optical Zoom Function

The optical zoom enables you to zoom the picture more clearly by the actual zooming action of the optical lens. The optical zoom is used up to the [×2] zooming ratio. If you increase the ratio more than that, it is replaced by the digital zoom.

1. During a video call, press [Options] and select “Enable Opt. Zoom”.

The image is magnified.

### Turning the Speakers On and Off

You can talk via the loud speakers on the back of the phone by turning them on.

1. During a video call, press [Options] and select “Loud Speaker On”.

### Note

- *In a high-noise environment, you may not be able to continue a call, or make a clear call. We recommend that you use the Stereo Headset and Handsfree Microphone Unit.*
- *With this option, you may not be able to continue a call without interruption if you increase the earpiece volume. We recommend that you decrease the earpiece volume or use the Stereo Headset and Handsfree Microphone Unit.*

### Video Call Settings

#### To Change the Quality of the Incoming Image

You can adjust the quality of the called party's image.

1. During a video call, press [Options] and select "Video Call Settings".
2. Select "Incoming Format".
3. Select "Normal", "Quality Prio." or "Frame Rate Prio."

"Normal": The standard quality is used.

"Quality Prio.": The quality of the picture takes precedence over the frame rate.

"Frame Rate Prio.": The frame rate takes precedence over the quality.

#### To Turn the Backlight On or Off

You can turn on the backlight of your screen.

1. During a video call, press [Options] and select "Video Call Settings".
2. Select "Backlight".
3. Select from "On", "As Normal Setting" or "Off".



When "On" is selected, the backlight will always be on during a video call.

When "As Normal Setting" is selected, the backlight will time out depending on the Backlight setting (p. 181).

## Voice Call/Video Call Functions







---

To Adjust the Video Exposure

1. During a video call, press [Options] and select “Video Call Settings”.
2. Select “Exposure”.
3. Press  (Light) or  (Dark).



## Top Menu

1. Press  during stand-by.  
The Main menu is displayed.
2. Press , ,  or  to highlight the desired menu, then press  to access the function.  
The sub menu is displayed.  
For details on the menu options, see the table on pages 248 and 249.

## Using the Menu in the Viewer Position of the Display

1. Set the phone in the viewer position of the display.
2. Press the camera key to display the Main menu.
3. Press the side-up or side-down key to move the focus up or down, then press the camera key.  
Press the cancel key to return to the Main menu.  
The focus moves the same as in the normal position of the display by using the side-up and side-down keys illustrated by arrows.  
For details on the functions of these keys, see page 18.

## Using the Menu

---

### Shortcuts

Your phone has a shortcut key (assigned to the shortcut key: ) with which you can access the desired menu quickly. The default shortcuts are as follows, which you can later customise:

- Dialed Numbers
- Received Calls
- Calendar
- Calculator
- Voice Recorder



#### To Use the Shortcuts

1. Press the shortcut key.
2. Select the desired item.

#### To Customise the Shortcuts

1. Press the shortcut key.
2. Press [Options] and select “Assign”.  
The list of the available items is displayed.
3. Select the desired item.

### Note

- To move the item in the list that appears in step 1, highlight the item, press [Options] and select “Move”.  
Then press  or  to the desired location and press .

When entering characters to create Contacts List entries, text messages or multimedia messages, etc., press the corresponding keys.

In multi-tap input method, press each key until the desired character is displayed. For example, press **2** once for the letter A or twice for the letter B.





### Table of Characters



Pressing each key scrolls characters in the following order. The order varies depending on the language selected.

#### English Mode

Key	Upper Case Characters	Lower Case Characters	Numeric
<b>1</b> <small>OD</small>	. (full-stop) , (comma) - (hyphen) ? ! ' (apostrophe) @ : 1		1
<b>2</b> <small>ABC</small>	ABC2	abc2	2
<b>3</b> <small>DEF</small>	DEF3	def3	3
<b>4</b> <small>GHI</small>	GHI4	ghi4	4
<b>5</b> <small>JKL</small>	JKL5	jkl5	5
<b>6</b> <small>MNO</small>	MNO6	mno6	6
<b>7</b> <small>PQRS</small>	PQRS7	pqrs7	7

## Entering Characters

Key	Upper Case Characters	Lower Case Characters	Numeric
	TUV8	tuv8	8
	WXYZ9	wxyz9	9
	(space) += <> € £ \$ ¥ % & 0		0
	Switches character case between four modes: Abc, ABC, 123 and abc.		
	. , ? ! : ; - + # * @ " ( ) _ & € £ \$ % / ^ < > § = \   ¥ ÷ ¡ ¢ £ ¤ ¥ ¦ § ¨ © ª « ¬ ® ¯                 à á â ã ä å ç è é ê ë ì ï ð ñ ò ó ô õ ö ø ù ú û ü ÿ Δ Φ Γ Λ Ω Π Ψ Σ Θ Ξ (space) ↵		

 -  : Press and hold to enter 0 - 9 numbers.



 : Press and hold to shift between multi-tap and T9 mode.

 : Press and hold to display the Input Language screen.

## Changing the Input Languages







You can change the input language on the text entry screen.

1. On the text entry screen, press [Options] and select “Input Language”.
2. Select the desired language.

## Changing the Input Mode

### T9 Text Input

T9 text input method is a shortcut to enter text easily and quickly.

1. On the text entry screen, press and hold  to enter T9 mode.
2. Press [Options] and select “Input Mode”.
3. Select the input mode (Abc, ABC, abc, 123).
4. Press each key once for any letter you require on that key.  
To enter the word “How”, press   .
5. If the word shown isn’t the one you want, press  or  until you highlight the correct one.
6. Press  to select the word.

### Note

- If the correct word is not shown in step 5, enter the correct word again after switching to the multi-tap input method.



## Entering Characters

---

### **Tip**

- If you press  instead of step 6, a space is inserted next to the selected word.

### Symbols and Punctuation

1. On the text entry screen, press [Options] and select “Add Symbol”.
2. Select the desired symbol.

### My Dictionary

You can create your own word list for T9 text input.

1. On the text entry screen in T9 mode, press [Options] and select “My Dictionary”.
2. Select “Add New Word” and enter a new word.

To edit a word in the list

1. On the text entry screen in T9 mode, press [Options] and select “My Dictionary”.
2. Highlight the desired word.
3. Press [Options] and select “Edit”.
4. Modify the word.

## Using Templates

You can use the sentences registered in Text Templates when entering characters. For details on creating the text template, see “Adding Phrases to Text Templates” on page 139.



1. On the text entry screen, move the cursor to the point you wish to insert the template.
2. Press [Options] and select “Advanced”.
3. Select “Insert Template”.
4. Select the desired text template.

The selected text template is inserted.

## Copying, Cutting and Pasting Text

By using these options, you can carry out editing smoothly.

### To Copy and Cut Text

1. On the text entry screen, press [Options] and select “Advanced”.
2. Select “Copy” or “Cut”.
3. Move the cursor to the first letter to be copied or to be cut, then press .
4. Move the cursor to the last letter to highlight the area, then press .

## Entering Characters

---

### To Paste Text

1. On the text entry screen, move the cursor to the point you wish to paste the letters.
2. Press [Options] and select “Advanced”.
3. Select “Paste”.

The saved text is pasted.

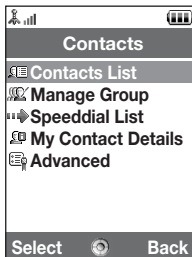

You can store the phone numbers and email addresses of your friends, family and colleagues in the Contacts List.

Your phone can store up to 500 entries. In a Contacts List, you can save the following items:

### Items Saved in the Handset Memory

First Name:	up to 16 characters
Last Name:	up to 16 characters
Tel 1:	up to 32 digits
Tel 2 (displayed if "Tel 1" is entered):	up to 32 digits
Tel 3 (displayed if "Tel 2" is entered):	up to 32 digits
Email1:	up to 128 characters
Email2 (displayed if "Email1" is entered):	up to 128 characters
Email3 (displayed if "Email2" is entered):	up to 128 characters
Group:	16 groups (Group names can be edited by the Manage Group menu.)
Street Name:	up to 64 characters
City Name:	up to 64 characters
State Name:	up to 64 characters
Postcode:	up to 20 characters
Country Name:	up to 32 characters
Note:	up to 256 characters

## Contacts List

---

Birthday:

Picture:

Assign Tone/Video (For Voice Call, For Video Call, For New Message):

Secret:

### Items Saved in the SIM Memory

Name: up to 16 characters

Tel 1: up to 32 digits

Tel 2 (displayed if "Tel 1" is entered):  
up to 32 digits

Email1: up to 80 characters

Group: 11 groups (Group names can be edited using the Manage Group option.)

Using the infrared or *Bluetooth* wireless function, you can send the Contacts List entry to a PC to share the same entries.

## Changing the Name Order

***"Contacts" → "Advanced" → "Name Order"***

1. Select "First–Last Name" or "Last–First Name".

## Changing the List Displayed

***"Contacts" → "Advanced" → "Contacts Location"***

1. Select "Handset" or "SIM".

## Selecting the Storage Memory

***“Contacts”*** → ***“Advanced”*** → ***“Save New Contact to”***

1. Select the Contacts location from “Handset”, “SIM” or “Choice”.

### ***Tip***

- *“Choice” prompts you to choose the memory every time you save a new entry.*

## Changing the Contact List Order

You can change the listing order of the Contacts List entries between by alphabet order or by group.

***“Contacts”*** → ***“Advanced”*** → ***“View Contacts”***

1. Select “By Alphabet” or “By Group”.

## Add New Contact

You can choose either the phone or SIM card memory locations to store the new entry. For switching locations, see “Selecting the Storage Memory”.

The amount of phone numbers that you can store to the SIM card is dependent on its capacity. Contact your network operator for details.

***“Contacts”*** → ***“Contacts List”*** → ***“Add New Contact”***

If you select the “Choice” option for the memory to be used, the selection is between “To Handset” and “To SIM”.

1. Select the field you wish to fill in, and enter the relevant information.
2. Press [Save] when finished.

## Contacts List

---

### **Tip**

- *To create an entry, at least one field must be filled (“First Name”, “Last Name”, “Tel 1 ” or “Email1” for the handset memory; “Name”, “Tel 1” or “Email1” for the SIM memory).*

### **Adding a Thumbnail to Entries**

#### **“Contacts” → “Contacts List”**

1. Highlight the desired entry.
2. Press [Options] and select “Edit”.
3. Select “Picture:”.
4. Select “Assign Picture”.
5. Select the desired picture.
6. Press [Save] when finished.

### **Note**

- *If you delete a picture in the handset memory, the corresponding thumbnail is also deleted.*

### **Viewing My Contact Details (M 8–4)**

You can register and edit your own contact as other Contacts List entries.

#### **“Contacts” → “My Contact Details”**

## Copying Contacts List Entries between SIM Card and Handset

**“Contacts”** → **“Advanced”** → **“Copy All Entries”**

1. Select “SIM to Handset” or “Handset to SIM”.

### **Note**

- When you insert the SIM card into your phone for the first time and start the Contacts List application, the confirmation screen is displayed automatically, asking you if you wish to copy or not. The number of Contacts List entries to be copied varies depending on the SIM capacity.
- If the memory space is not enough to save all entries, you cannot complete copying.

## Finding a Name

**“Contacts”** → **“Contacts List”**

1. Enter the first few letters of the name.  
Search results are displayed in alphabetical order.

### **Tip**

- You can select the Contacts location from “Handset” or “SIM” before searching.

## Dialling from the Contacts List

**“Contacts”** → **“Contacts List”**



1. Highlight the desired entry and press .



## Contacts List

---

### Tip

- If more than one phone number is registered for the entry, highlight the desired phone number after step 1 and press .
- You can also dial from the details screen of the Contacts List. On the details screen, select the desired phone number and press .

## Editing Contacts List Entries

### ***“Contacts”*** → ***“Contacts List”***

1. Highlight the entry you wish to edit.
2. Press [Options] and select “Edit”.
3. Modify the information.
4. Press [Save] when finished.

## Deleting Contacts List Entries

### Deleting All Contact Entries

#### ***“Contacts”*** → ***“Advanced”*** → ***“Delete All Entries”***

1. Select “Handset Entries” or “SIM Entries”.
2. Enter your handset code.

The default handset code is “9999”. For details on changing the handset code, see “To Change the Handset Code” on page 199.

### Deleting a Contact Entry

#### ***“Contacts”*** → ***“Contacts List”***

1. Highlight the desired entry.
2. Press [Options] and select “Delete”.

### Manage Group (M 8–2)

Different ringtones can be set for each group. If you do not change a group ringtone, the ringtone assigned in the Settings menu is used.

#### ***“Contacts”*** → ***“Manage Group”***

1. Highlight the desired group.
2. Press [Options] and select “Assign Tone/Video”.
3. Select from “For Voice Call”, “For Video Call” or “For New Message”.
4. Select “Assign Tone” or “Assign Video”.  
When selecting “Assign Video”, go to step 6.
5. Select “Preset Sounds” or “My Sounds”.
6. Select the desired tone or video clip.

For details on selecting a ringtone or a ring video clip in the Settings menu, see “Assigning a Ringtone” on page 173 or “Assigning a Ring Video Clip File” on page 174.

#### **Note**

- *You can only edit group names in the SIM card. You cannot edit the ringtone or ring video settings.*

## Contacts List

---

### Editing the Group Name

You can edit group names to be assigned to the Contacts List entries. First, change the Contacts List displayed (p. 60).

***“Contacts”*** → ***“Manage Group”***

1. Highlight the desired group name.
2. Press [Options] and select “Edit Name”.
3. Modify the name.

### Assigning a Ringtone or a Ring Video Clip to Each Contacts List Entry

A specified ringtone or vibration setting can be associated to a pre-registered entry.

***“Contacts”*** → ***“Contacts List”***

1. Highlight the desired entry.
2. Press [Options] and select “Edit”.
3. Select “Assign Tone/Video”.
4. Select “For Voice Call”, “For Video Call” or “For New Message”.
5. Select “Assign Tone” or “Assign Video”.  
When selecting “Assign Video”, go to step 7.
6. Select “Preset Sounds” or “My Sounds”.

**7. Select the desired tone or video clip.**

For details on selecting a ringtone or a ring video clip in the Settings menu, see “Assigning a Ringtone” on page 173 or “Assigning a Ring Video Clip File” on page 174.

**8. Press [Save] when finished.****Memory Status**

This function helps you to check the memory used in the Contacts List.

**“Contacts” → “Advanced” → “Memory Status”**

**Speeddial List (M 8–3)**

You can set a maximum of 8 phone numbers in the speeddial list (p. 37).

**Setting Contacts List Entries in the Speeddial List**

**“Contacts” → “Contacts List”**

1. Select the desired entry.
2. Highlight the desired phone number.
3. Press [Options] and select “Add to Speeddial”.
4. Select the desired location.

**Tip**

- The nine digit keys correspond to list numbers.
- To view the speeddial list, see “Speed Dialling” on page 37.

## Contacts List

---

To Edit the Speeddial List

***“Contacts”*** → ***“Speeddial List”***

1. Highlight the entry you wish to edit.
2. Press [Options] and select the desired option.

“Re-Assign” (displayed when a phone number is already assigned):

Displays the Contacts List entries. Select (Reassign) other entries.

“Assign” (displayed when no phone number is assigned):

Displays the Contacts List entries. Select (assign) the desired entry.

“View”:  
Displays the assigned phone number.

“Delete”:  
Deletes the selected phone number from the speeddial list.

“Clear All”:  
Clears all phone numbers from the speeddial list.

## Sending a Contacts List Entry

***“Contacts”*** → ***“Contacts List”***

1. Highlight the desired entry.
2. Press [Options] and select “Send Contact”.
3. Select “As Message”, “Via Bluetooth” or “Via Infrared”.

### For “As Message”

For details, see “MMS” on page 87.

### For “Via Bluetooth”

For details, see “Bluetooth” on page 206.

### For “Via Infrared”

For details, see “Infrared” on page 212.

## Receiving a Contacts List Entry

When the phone receives a Contacts List entry, a confirmation message is displayed during stand-by.

### 1. Press [Yes].

The received entry is saved in the Contacts List. Press [No] to reject.

### **Tip**

- For details on making Infrared or Bluetooth wireless settings, see “Connectivity” on page 206.
- For details on making MMS settings, see “MMS Settings” on page 103.

## Camera (M 5)

---

Your phone has an integrated digital camera.



This allows you to shoot and send pictures and video clips wherever you are.

### Taking Pictures

#### “Camera”

1. Press  to take the picture.  
The shutter sounds and the still image of the taken picture is displayed.
2. Press [Save].  
To cancel, press [Cancel].  
The taken picture is saved in My Items.

#### Note

- Press the camera key instead of  in the viewer position of the display.
- When the digital camera is not activated, press [Options] and select “Go to Photo Camera”, or press .

#### Taking a Self-Portrait

You can take a self-portrait while looking at the main display.

1. Rotate the main display 180° clockwise from the normal position.
2. Press the camera key on the side of the phone.





**Note**

- *Do not rotate the main display anti-clockwise. Otherwise, the phone may malfunction.*

**Sending Taken Pictures**

You can send the taken picture via "With Message" or "live! Postcard". (The Postcard service is not available with some service providers. Contact your service provider for more information.)

**"Camera"**

1. Press  to take the picture.
2. Press .
3. Select the send option.

For details, see "Creating a New Message" on page 87. After the message has been sent, the taken picture is stored in My Items. (The resized picture is not saved in My Items.)

**Note**

- *When you try to send the picture that has too large a file size, the picture size is resized for the message. The original sized picture is saved in My Items.*



## Camera

---

### Selecting the Picture Size

You can select the size of pictures. All taken pictures are saved in the JPEG format.



**“Camera”** → **[Options]** → **“Picture Settings”** → **“Picture Size”**

1. Select the desired size.

Picture Sizes: 1224 × 1632 dots  
960 × 1280 dots  
768 × 1024 dots  
480 × 640 dots  
240 × 320 dots  
120 × 160 dots  
120 × 128 dots

### Using the Digital Zoom Function

To Adjust the Zooming Ratio

1. In the viewfinder mode, press  or .

### To Enable or Disable the Optical Zoom

The optical zoom enables you to zoom the picture more clearly by the actual zooming action of the optical lens. The optical zoom is used up to the [ $\times 2$ ] zooming ratio. If you increase the ratio more than that, it is replaced by the digital zoom.

**“Camera” → [Options] → “Advanced”**

#### 1. Select “Enable Opt Zoom”.

Select “Disable Opt Zoom” to disable.

If you select “Disable Opt Zoom”, you can only use the digital zoom function.

#### 2. Press or .

Once the phone has returned to the stand-by screen, the zoom settings return to default.

### Adjusting the Exposure

**“Camera” → [Options] → “Picture Settings” → “Exposure”**

#### 1. Press (Bright) or (Dark).

Picture brightness (exposure level) indicators

     : (Bright → Normal → Dark)

Once the phone has returned to the stand-by screen, the brightness settings return to default.

### Mobile Light

#### To Change the Light Colour

You can take a picture in various colour modes.

**“Camera” → [Options] → “Picture Settings” → “Mobile Light” → “Light Colour”**

## Camera

---

### 1. Select the desired light colour.

Light Colours: White/Red/Yellow/Green/Blue/Violet/Light Blue/Disco

### To Change the Mobile Light Mode

Set the mobile light according to your purpose.

**“Camera” → [Options] → “Picture Settings” → “Mobile Light” → “Switch On/Off”**

### 1. Select the desired mode.

“On” (☀): The light is always on.

“Auto” (☁): The light turns on if the phone detects that the conditions are dark.

“Low Light” (🌙): Select this mode for macro shooting.

“Off”: The light is always off.

The corresponding indicator is displayed on the screen. Select “Off” to turn it off.

### Using the Timer (Timer)

**“Camera” → [Options] → “Camera Modes” → “Timer”**

### 1. Select “On” or “Off”.

“🕒” is displayed on the screen when you select “On”.

### Selecting the Scene

You can select the appropriate mode by scene when you take the picture.

**“Camera” → [Options] → “Picture Settings” → “Scene”**

### 1. Select the desired scene.

## Continuous Shoot

You can take continuous shoots in various options.

**“Camera”** → **[Options]** → **“Camera Modes”** → **“Continuous Shoot”**

### 1. Select the desired mode.

The following continuous shoot modes are available:

“Off”:

The continuous shoots are cancelled.

“4 Pictures”/“9 Pictures”: Takes 4 or 9 pictures continuously.

After selecting this mode, select the desired speed from the following:

“Very Fast”

“Fast”

“Normal”

“Slow”

“Very Slow”

“Manual”



“Bracket”:

Takes 9 continuous pictures with various colours and brightness levels.

After selecting this mode, press  then select “Fast” or “Normal”.



“Overlapped”:



Overlaps continuous pictures into one picture and makes an afterimage.

After selecting this mode, press  then select “Fast” or “Normal”.

## Camera

---

### Note

- When you select “Manual” to take continuous pictures, press  or the camera key (in the viewer position of the display) manually in the desired speed.
- When the Timer and Continuous Shoot functions are simultaneously set, “ ” (for “4 Pictures”, for example) is displayed instead.

### Selecting a Frame

You can select the frame from preset patterns. You can also select a frame in Saved Pictures.

**“Camera”** → **[Options]** → **“Camera Modes”** → **“Photo Frame”**

1. Select “Preset Frames” or “My Pictures”.
2. Select the desired frame.  
The selected frame is confirmed on the display.
3. Press .

### Note

- Images larger than 240 dots [W] × 320 dots [H] cannot be used.

### Switching to the Video Camera Mode

You can switch from the camera mode to the video camera mode. You can also switch between these two modes by pressing .

**“Camera”** → **[Options]** → **“Go to Video Camera”**

### Using the Full Screen

You can display the preview on the full screen without the soft key area and indicator area.

**“Camera” → [Options] → “Advanced”**

1. Select “Full Viewfinder”.

To return to the normal viewfinder, select “Normal Viewfinder”.

### Selecting the Picture Quality

**“Camera” → [Options] → “Picture Settings” → “Picture Quality”**

1. Select the desired picture quality.

Picture quality indicators

⋯**S****F** : Super Fine

⋯**F** : Fine

⋯**N** : Normal

### Selecting the Shutter Sound

You can select the shutter sound from 3 preset patterns.

**“Camera” → [Options] → “Advanced” → “Shutter Sound”**

1. Select the desired shutter sound.

#### Note

- *Continuous Shoot uses the specialised shutter sound that cannot be changed from the above settings.*

## Camera

---

### Selecting the Storage Memory

You can select the location to save the taken pictures in.

**“Camera”** → **[Options]** → **“Advanced”** → **“Save New Pictures to”**

1. Select the desired location from “Handset Memory”, “Memory Card” or “Choice”.

#### **Note**

- If you select “Choice”, select the desired location every time you save.

### Focus Setting

This function enables you to set the focus mode along with the situation for taking a picture.

**“Camera”** → **[Options]** → **“Advanced”** → **“Focus Setting”**

1. Select the desired option.

Focus mode indicators

AF : Normal

 : Macro

MF : Manual Focus

**Auto Save**

You can set the phone to save pictures automatically.

***“Camera” → [Options] → “Advanced” → “Auto Save”***

1. Select “On”.

Select “Off” to disable.

**Using the Help Function**

***“Camera” → [Options] → “Help”***

**Exiting from the Viewer Position of the Display**

Carry out the following operation when you want to go back from the viewer position of the display to the normal position.

1. Press and hold the cancel key in the viewer position.





### Recording Video Clips

You can record a video clip with your phone. You can also use this function in the viewer position of the display.

#### Recording Video Clips

##### “Camera”

The preview is displayed through the screen.

1. Press .  
Press the camera key in the viewer position of the display.
2. To stop recording, press .  
To view the preview before saving, select “Preview”.
3. Select “Save”.  
The video clip is saved in My Items.

##### Note

- If you want to record a video clip in landscape, set the phone to the viewer position of the display while in the viewfinder mode. The display switches to landscape automatically.
- Put the phone into the video camera mode to record a video. Video clips are saved in “.3gp” format in the following two modes:

 For Message:      QCIF or SubQCIF

 Extended Video:    QCIF, SubQCIF or QVGA (MPEG4)

QVGA (MPEG4) is available when you select “Extended Video” for the Recording Time (p. 83) and select QVGA (MPEG4). The video clips are saved in “ASF” format.



- The sound can be recorded with a video clip if the microphone is turned on. The default setting of the microphone is set to "On". To record a video clip without the sound, turn off the microphone. For details, see "Recording Video Clips with the Sound" on page 85.

### **Sending Video Clips**

#### **"Camera"**

1. Press .

Press the camera key in the viewer position of the display.

2. To stop recording, press .

To view the preview before saving, select "Preview".

3. Select "Save and Send".

Select the desired way you wish to send.

For details, see "Creating a New Message" on page 87.

#### **Note**

- You can send video clips only when "For Message" is selected for the recording time. For details, see "Selecting the Recording Time" on page 83.

### **Using the Zoom Function**

To Adjust the Zooming Ratio

1. In the viewfinder mode, press  or .

## Camera

---

### To Enable or Disable the Optical Zoom

The optical zoom enables you to zoom the picture more clearly by the actual zooming action of the optical lens. The optical zoom is used up to the [x2] zooming ratio. If you increase the ratio more than that, it is replaced by the digital zoom.

**“Camera” → [Options] → “Advanced”**

1. Select “Enable Opt Zoom”.

Select “Disable Opt Zoom” to disable.

2. Press  or .

### Note

- The default setting is “Enable Opt Zoom”. If you select “Disable Opt Zoom”, you can use only the digital zoom function.

### Adjusting the Exposure

**“Camera” → [Options] → “Video Settings” → “Exposure”**

1. Press  (Bright) or  (Dark).

Picture brightness (exposure level) indicators

     : (Bright → Normal → Dark)

Once the phone has returned to the stand-by screen, the brightness settings return to default.

### Mobile Light

You can record a video clip in various colour modes.

**“Camera” → [Options] → “Video Settings” → “Mobile Light” → “Light Colour”**

1. Select the desired light colour.

Light Colours: White/Red/Yellow/Green/Blue/Violet/Light Blue/Disco

### To Change the Mobile Light Mode

Set the mobile light according to your purpose.

**“Camera” → [Options] → “Picture Settings” → “Mobile Light” → “Switch On/Off”**

1. Select the desired mode.

“On” (☀): The light is always on.

“Auto” (☁): The light turns on if the phone detects that the conditions are dark.

“Off”: The light is always off.

The corresponding indicator is displayed on the screen. Select “Off” to turn it off.

### Selecting the Recording Time

**“Camera” → [Options] → “Video Settings” → “Record Time”**

1. Select “Extended Video” or “For Message”.

For Message: Limits the size to send a message depending on service providers.

Extended Video: Less than 30 minutes (depending on the memory).

## Camera

---

### Note

- If you select “For Message” for the recording time, the file size is limited depending on the service provider. Therefore, the quality is also limited for the setting.
- “Save and Send” is not displayed after recording in the Extended Video mode.
- When you select “Extended Video”, you can select the video format from “QCIF or SubQCIF” or “QVGA(MPEG4)”.

### Switching to the Photo Camera Mode

You can switch to the digital camera mode. You can also switch to the photo camera mode by pressing .

**“Camera” → [Options] → “Go to Photo Camera”**

### Selecting Video Quality

**“Camera” → [Options] → “Video Settings” → “Video Quality”**

1. Select the desired video quality.

Video quality indicators

 : Super Fine

 : Fine

 : Normal

### Note

- The better quality you select, the larger file size is needed.

### Recording Video Clips with the Sound

To record a video clip with the sound, the microphone needs to be activated.

**“Camera”** → **[Options]** → **“Video Settings”** → **“Microphone”**

1. Select “On” or “Off”.

#### **Note**

- The microphone is already turned on in the default setting. Select “Off” to record a video clip without the sound.

#### **Tip**

- The file size of a video clip can be reduced if the sound is not recorded.

### Changing the Picture Size

You can change the picture size during playback/recording.

**“Camera”** → **[Options]** → **“Advanced”** → **“Picture Size”**

1. Select “Large(QCIF)” or “Small(SubQCIF)”.

### Selecting the Storage Memory

You can select the location to save the recorded video clips.

**“Camera”** → **[Options]** → **“Advanced”** → **“Save New Videos to”**

1. Select the desired location from “Handset Memory”, “Memory Card” or “Choice”.

#### **Note**

- If you select “Choice”, select the desired location every time you save.

## Camera

---

### Focus Settings

This function enables you to adjust the focus automatically along with the situation for recording a video clip.

***“Camera” → [Options] → “Advanced” → “Focus Setting”***

1. Select the desired option.

Focus Mode indicators

 : Normal

 : Macro

 : Manual Focus

To Use the Help Function

***“Camera” → [Options] → “Help”***

### Video Encoding

***“Camera” → [Options] → “Advanced” → “Video Encode”***

1. Select the appropriate format.

### Exiting from the Viewer Position of the Display

Carry out the following operation when you want to go back from the viewer position of the display to the normal position.

1. Press and hold the cancel key in the viewer position.

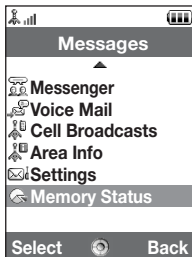
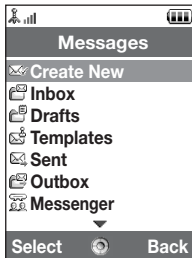

Your phone allows you to send and receive text, multimedia and email, and receive WAP alerts as well.

### MMS

MMS allows you to send and receive multimedia messages of up to 300 KB with images, sound, or video clips attached.

#### Note

- **Some MMS functions may not always be available depending on your network. Contact your network operator for more information.**
- *Maximum message size varies depending on the settings by the network operator.*

### SMS

SMS allows you to send text messages up to 765 characters long. If you send a message more than 160 characters, it is split into several segments.

### Email

Email allows you to send messages of up to 300 KB.

#### Creating a New Message

##### (For Email)

☐ → "Create New" → "E-mail"

##### (MMS/SMS)

☐ → "Create New" → "Message"

1. Enter the message.



## Messages

---

### 2. (Email/MMS)

Press [Options] and select "Insert Item", if you wish to attach files.

### 3. (Email/MMS)

Select the desired item. Details are given in the following sections.

"Pictures": Attaches picture files.

"Sounds": Attaches sound files.

"Videos": Attaches video clip files.

"Attach Contact": Attaches Contacts List entries.

"Attach Appointment": Attaches Schedule entries.

### 4. Select "Send".

### 5. (MMS)

Enter or select the email address or phone number from the Contacts List.

#### (SMS)

Enter or select the phone number from the Contacts List.

#### (Email)

Enter the email address from the Contacts List.

To add multiple email addresses or phone numbers (up to 20), highlight the recipient field, press [Options], select "Edit & Add Recipients", then select "Add Recipient".

Enter or select the email address or phone number, or select from the existing Contacts List.

Up to 20 digits (MMS/SMS) or 128 characters (Email/MMS) can be entered for each email address or phone number.

To change the recipient types, press [Options], select "Edit Recipients" and select "Change to TO", "Change to CC" or "Change to BCC" (Email/MMS).

**6. (Email/MMS)**

Select the subject field and enter the subject.

**7. (MMS/SMS)**

Transportation type (SMS or MMS) is shown in the field of "Message Type". Select the field and select the desired transportation type.

**8. Select "Advanced" to set the advanced message sending options.**

- "Delayed Delivery" ("No delay", "30 minutes", "1 hour", "6 hours", "1 day", "1 week") (for MMS):  
Sets the time the message is delivered after the Send key is pressed.
- "Delivery Report" ("Yes", "No") (for MMS/SMS):  
Enables or disables Delivery Report when the message is successfully sent to the recipient.
- "Expiry Time" ("Never delete", "30 minutes", "1 hour", "6 hours", "1 day", "1 week") (for SMS/MMS):  
Sets Expiry Time for a message to be saved in the server.
- "Priority" ("High", "Normal", "Low"):  
Prioritises composed messages.
- "Read Report" ("Yes", "No") (for MMS/SMS):  
Enables or disables Read Report when the recipient is required to inform the sender that the message has been read.

**9. Highlight "Send", then press  to send.**

After the message is sent, the message is moved to the Sent box.

## Messages

---

### **Note**

- *The current message size displayed while you are creating the message is an approximation.*
- *If a message cannot be sent for some reason, the message stays in the Outbox and the “✉” is displayed during stand-by.*

### **Tip**

- *To save the message without sending, select [Options] and select “Save to Drafts” in step 2.*
- *You can send the following items attached to multimedia messages. Details are given in the following sections.*
  - *My Items data*
  - *Contacts List entry*
  - *File (Schedule entry created by Calendar, Contacts List entry), etc.*
- *You can use the template option to help you compose messages. For details on using this option, see “Using Templates” on page 57.*

### **To Attach My Items Data**

1. In step 3 in “Creating a New Message” on page 87, select from “Pictures”, “Sounds” or “Videos”.

### **2. Select the desired file.**

If you wish to take new pictures, record sounds or video clips, select “Take Picture”, “Record Sound” or “Record Video”.

- (For pictures)

For attached pictures, select the appropriate resize option, as the maximum message size for sending varies depending on the network operator.

- (For sounds)

For attached sounds, select the appropriate format option, as the maximum message size for sending varies depending on the network operator.

### **To Attach a Schedule Entry**

- 1.** In step 3 in “Creating a New Message” on page 87, select “Attach Appointment”.
- 2.** Select the desired day including a schedule entry you wish to add.
- 3.** Select the desired schedule entry.

### **To Add Information from a Contacts List Entry**

- 1.** In step 3 in “Creating a New Message” on page 87, select “Attach Contact”.
- 2.** Select the desired entry.

If you wish to select your own Contacts List entry, select “My Contact Details”.

- 3.** Select the desired field.

The selected information is entered.

## Messages

---

### To Add a Slide Show

1. In Step 2 in “Creating a New Message” on page 87, select “Options” and select “Add Slide”.  
If you wish to add more slides, select “Add Slide Before” or “Add Slide After”.
2. Enter the message.  
If you wish to set the duration of each slide, press [Options] and select “Slide duration”, then select the desired duration.

### **Tip**

- *You can create messages up to 300 KB. Each slide can contain one picture and/or one sound file or video clip.*

### To Remove or Replace Attachments

1. In step 3 in “Creating a New Message” on page 87, press [Options] and select the corresponding remove option for each attachment.

### **Sending a Message in the Drafts Box**

 → **“Drafts”**

1. Select the desired tab, SMS/MMS or Email.
2. Press [Options] and select “Edit & Send”.
3. Modify the message, if necessary.
4. Select “Send”.
5. Highlight “Send”, then press  to send.

### Reading MMS

Messages you receive are saved in the Inbox.

#### To View Messages Before Downloading

The MMS indicator (  ) is displayed when you are receiving an incoming message.

 → **"Inbox"**

1. Select the message alert you wish to view.

#### Tip

- *The volume varies depending on the Application Volume settings (p. 146). The sound is deactivated when "Application Volume" is set to "Silent".*

### Storing the Phone Number of a Sender in the Contacts List

 → **"Inbox"**

1. Highlight the message from which you wish to store the phone number or email address.
2. Press [Options] and select "Save address".

The new Contacts List entry screen including the phone number is displayed. For details on creating a new Contacts List entry, see "Add New Contact" on page 61.

### Calling the Phone Number of a Sender Embedded in the Message

 → **"Inbox"**

1. Highlight the message including the phone number you wish to dial.
2. Press [Options] and select "Call Sender".

## Messages

---

### Downloading a Single MMS

 → **"Inbox"**

1. Highlight the message alert () you wish to download.
2. Press [Options] and select "Download".

The downloading starts and the indicator becomes .

#### **Tip**

- You can download multiple messages at the same time. See the next section.

### Downloading Multiple MMS

 → **"Inbox"**

1. Press [Options] and select "Advanced".
2. Select "Multiple Select".
3. Select the desired message alert using the "Select/Unselect" or "Select All" option.
4. Select "Download".

The selected messages are downloaded at the same time.

### Replying to a Message or to All Addresses

 → **"Inbox"**

1. Highlight the message the sender of which you wish to reply to.
2. Press [Options] and select "Reply" or "Reply all".
3. Enter the message.
4. Press "Send".
5. Highlight "Send" then press  to send.

### Forwarding a Message

 → *"Inbox"*

1. Highlight the message you wish to forward.
2. Press [Options] and select "Forward".
3. Perform steps 2 to 9 in "Creating a New Message" on page 87.

### Remote Forward

You can transfer your email messages saved in the mail server directly to other recipients.

 → *"Inbox"*

1. Highlight the message alert () you wish to transfer.
2. Press [Options] and select "Forward".
3. Perform steps 2 to 5 in "Creating a New Message" on page 87.

### Sorting the Messages in the List

 → *"Inbox"*

1. Press [Options] and select "Advanced".
2. Select "Sort".
3. Select the desired sort type.

### Locking or Unlocking the Messages

 → *"Inbox"*

1. Highlight the message you wish to lock or unlock.
2. Press [Options] and select "Advanced".
3. Select "Lock/Unlock".



## Messages

---

### **Sending a Picture File with Postcard**

Your phone allows you to send multimedia messages to a Vodafone specific Postcard service centre that prints the picture and mails it to the recipient's home address specified in the MMS message. (Your phone is initially provided with the address of a Vodafone specific Postcard service centre, and its address cannot be changed.)

#### **Note**

- *This service is not available with some service providers. Please contact your service provider for more information.*

To Create a New Postcard

☐ → **“Create New”** → **“live! Postcard”**

1. Select a picture you wish to send.
2. Enter your message.
3. Press [OK].
4. Enter the following information for the recipient.

See the note below for details.

- “Name”
  - “Additional Information”
  - “Address”
  - “City”
  - “Post Code”
  - “County”
  - “Country”
  - “Send Postcard”
5. Press [Options] and select “Send”.

### **Note**

- *The items "Name", "Address" and "City" are necessary to complete sending Postcards.*
- *Information for a recipient*
  - "Name" (mandatory):*
    - Name of the recipient for a postcard up to 50 characters*
  - "Additional Information" (optional):*
    - Additional information of the recipient up to 50 characters*
  - "Address" (mandatory):*
    - Street and number up to 50 characters*
  - "City" (mandatory):*
    - City up to 50 characters*
  - "Post Code" (optional):*
    - Postal code up to 20 characters*
  - "County" (optional):*
    - State, province, and region or province up to 50 characters*
  - "Country" (optional):*
    - Country up to 20 characters*
- *The items displayed differ according to the service. Please contact your service provider for more information. The item "Country" may not be displayed, so you cannot send Postcards overseas from your phone.*
- *Files in Animation GIF format cannot be used for the Postcard service.*
- *The picture quality of Postcards varies depending on the picture size.*

### Cell Broadcasts (M 4–10)

You can receive cell broadcast messages or general messages such as weather forecasts and traffic reports. This information is broadcast to subscribers in certain network areas.

This function may not be available on all mobile phone networks. Contact your network operator for more information.

#### Enabling/Disabling Cell Broadcasts

***“Messages”*** → ***“Cell Broadcasts”*** → ***“Switch On/Off”***

1. Select “On” or “Off”.

#### Reading Cell Broadcast Messages

***“Messages”*** → ***“Cell Broadcasts”*** → ***“Read Messages”***

1. Select the desired subject.
2. Scroll the screen to read the message.
3. Press [Back].

#### Setting Languages

You can select your preferred language for the cell broadcast message display.

***“Messages”*** → ***“Cell Broadcasts”*** → ***“Settings”*** → ***“Language”***

The current language is displayed.

1. Press .

The language list is displayed.

2. Select the desired language.
3. Press [Save].

### **Subscribing to Cell Broadcasts**

Select the page of the cell broadcast message that you want.

***“Messages” → “Cell Broadcasts” → “Settings” → “Set Info Subjects” → [Options]***

1. Select “Add/Remove”.
2. Select the desired page.
3. Press [Back].

### ***Tip***

- *If the desired page is not in the list that appears in step 2, select “Create Subject” in step 1, then enter the subject code to add a page. For details on the subject code, contact your service provider.*

## Messages

---

### Area Info (M 4–11)

The Area Info is the message information that operators send to subscribers in certain areas.

When you receive Area Info, the message (area code) is displayed during stand-by.

#### **Note**

- *This function may not be available on all mobile phone networks. Contact your network operator for more information.*

#### **Enabling/Disabling Area Info**

**“Messages”** → **“Area Info”**

1. Select “On” or “Off”.

#### **Note**

- *If Area Info is set to “On”, the stand-by time will decrease.*

---

## Setting Up MMS/SMS/Email (M 4–12)

### General Settings

***“Messages” → “Settings” → “General Settings”***

1. Select the item you wish to set up.
  - “Home Download” (“Always download”, “Always defer”):  
Controls message download timing inside your network area.  
“Always download”: Downloads messages immediately from the server.  
“Always defer”: Defers message download.
  - “Roam. Download” (“Always download”, “Always defer”):  
Controls message download timing when roaming outside of your network.  
“Always download”: Downloads messages immediately from the server.  
“Always defer”: Defers message download.
  - “Delivery Report”:  
Enables or disables Delivery Report request.
  - “Read Report”:  
Enables or disables Read Report request.
  - “Expiry Time”:  
This indicates the number of days and hours for which a message you send may remain undelivered to the message recipient. During this period, the message service centre will continually try to deliver the message to the recipient.  
Select the validity period.

## Messages

---

- “Delivery Rep. Allow”:  
Enables or disables Delivery Rep. Allow when receiving a message, which applies to the Delivery Report function.
- “Auto Delete” (“None”, “Inbox”, “Sent”, “Both”):  
Deletes the oldest message automatically, when the Inbox, Sent or both (Inbox and Sent) is full.
- “Edit Signature”:  
Opens the screen to enter the signature.
- “Reply History” (“Yes”, “No”):  
Disables or enables whether the message will be added to your reply message or not.

### SMS Settings

**“Messages”** → **“Settings”** → **“SMS Settings”**

1. Select the item you wish to set up.
  - “Message Centre”:  
Enter the centre phone number.  
If you wish to enter a country code for a message to an international number, press and hold  until a + sign is displayed.
  - “Reply Path”:  
Accepts or rejects the same reply path with the send path when receiving the reply message for your message.

- “Message Format”:  
Select the message format to be used when creating a new message.
- “Optimisation”:  
When set “On” (default), double-byte characters such as European characters with an accent are converted into single-byte characters and sent.  
When “Off”, double-byte characters are sent as displayed.  
Please note that you may be charged double for double-byte characters sent in an SMS when Optimisation is set “Off”.  
Select “On” or “Off”.

### **MMS Settings**

***“Messages” → “Settings” → “MMS Settings”***

1. Select the item you wish to set up.
  - “Slide Duration”:  
Sets the duration of the slide.
  - “Max Message Size”:  
Defines the maximum size of messages that are downloaded.
  - “Creation Mode” (“Free”, “Restricted”):  
When set to “Free”, you can attach files of any format to the mail. When set to “Restricted”, only certain formats can be attached.



## Messages

---

### Email Settings

***“Messages”*** → ***“Settings”*** → ***“Email Settings”***

1. Select the item you wish to set up.
  - “Download Interval”:  
Sets the download interval.
  - “Max Message Size”:  
Defines the maximum size of messages that are downloaded.

Your phone is already configured to access Vodafone live! and the mobile internet\*.



Vodafone live! is a new mobile internet portal which is your gateway to a new world of information, games, music and services.

Because your phone uses 3G (UMTS), it has a system that is much faster than previous ways of getting mobile information. Also, the connection is 'always on' which means there is no need to wait for dialling up. You only have to pay for the data you send or receive, not how long you're connected.

\* If you have problems getting connected, please phone Vodafone Customer Support. Your phone contains a WAP browser used for surfing on the Mobile Internet, where you can get a lot of useful information. Normally, pages are designed for a mobile phone. Your phone is already setup to Vodafone site for WAP/MMS Settings.





## Starting the WAP Browser

1. Press  during stand-by.

## To Exit the WAP Browser

1. Press  to exit the browser.

## Navigating a WAP Page

- :  
Move the highlights around in the screen.
- :  
Executes the option displayed in the lower centre of the screen.
- :  
Launches the browser option menu.
- :  
Selects an action displayed in the lower right of the screen.  
Used to access "Vodafone live!" by opening the browser.
-  (short press):  
Exits the browser.  
(press and hold):  
Turns off the phone.

## Browser Menu

### To Edit Favourites

☐ → [Options] → **“Bookmarks”**

1. Select the desired URL, and press [Options].

You can edit the list of Bookmarks by the following options:

“Select”:	Selects a bookmark.
“Details”:	Displays detailed information of the WAP page.
“Send page”:	Sends the URL address to recipients.
“New”:	Creates new folders or bookmarks.
“Rename”:	Renames bookmarks.
“Edit URL”:	Edits URL address of the bookmark.
“Move”:	Moves Bookmarks to another location.
“Delete”:	Deletes bookmarks.
“Delete All”:	Deletes all bookmarks.

## The Browser Options

You can use various options of the WAP browser.

### ☐ → **[Options]**

- “Select”:  
Selects a WAP page.
- “Home”:  
Goes to the homepage.
- “Bookmarks”:  
(see page 107.)
- “Mark Page”:  
Marks the selected WAP page.
- “Save items”:  
Saves items from WAP pages.
- “Go to URL”:  
Goes to the WAP page that you enter the URL address.
- “Access History”:  
Shows the history where you have browsed.
- “Forward”:  
Goes to the next page of the pages displayed.
- “Reload Page”:  
Reloads the WAP page again to get new information.
- “Advanced”:  
Displays the advanced menus.
- “Exit”:  
Exits the browser.

## The Advanced Options

### ☐ → **[Options]** → **“Advanced”**

- “My Saved Page”:  
Displays the bookmarked pages.
- “Save this page”:  
Saves the WAP page as the local file.
- “Send page”:  
Sends the WAP page data.
- “Details”:  
Shows detailed information of the WAP page.
- “Browser Data”:  
Edits the browser data. You can clear the cache/cookies/  
history.

---

“Search This Page”:	Searches specific words in the WAP page.
“Alert Inbox”:	Displays WAP Push alerts.
“Copy Text”:	Copies the text on the web page.
“Settings”:	Displays the Settings menus.
“Restart browser”:	Restarts the browser.
“About”:	Displays the browser information.

### Browser Settings

☐ → **[Options]** → **“Advanced”** → **“Settings”**

“Send Referrer”:	Enables or disables the notification of the referrer.
“Cookies”:	Adjusts the setting of cookies.
“Downloads”:	Categorises downloading data from the images/sounds/objects.
“Security”:	Adjusts the security prompt level.
“IMEI Notification”:	Enables or disables the notification of mobile phone identification.
“Scroll step”:	Sets the speed of scrolling.
“Font Size”:	Sets the size of the browsing font.

## Media Player (M 3)

---

Media Player can play sound files and video clip files by switching between two applications: Music Player and Video Player. These applications can handle files in MP4 and 3gp (video clip, sound) format. While playing back sound files in the background, you can use other menus.

### Switching between Music Player and Video Player

When you start the Media Player for the first time, the Music Player is started.

#### **“Media Player”**

The list of the last-launched player (All Videos or All Music) is displayed.

1. When the desired playlist is not displayed, press [Options] and select “Open Video” or “Open Music”.
2. Select “Handset Memory” or “Memory Card”.

### Music Player

#### Playing Back Sound Files

##### **“Media Player”**

1. Select the desired file.  
To pause playback, press .

#### **Note**

- *You are asked whether or not to play sounds when the Silent mode is activated.*

### **Tip**

- You can return to the Main menu screen while playing back the file in the background.
- You can create your playlist listing only the desired files (p. 113).
- You can make tone adjustment in step 1. Press [Options] and select “Tone Control”. Select from “Normal”, “Bass”, “Surround” or “Surround Bass”.
- You can select the playback pattern in step 1. Press [Options] and select “Playback Pattern”.

*“Normal”:* Plays back all files in the selected folder once and stops playback.

*“Repeat”:* Continues to play back the selected file.

*“Repeat All”:* Plays back all files in the selected folder.

*“Random”:* Plays back files in the selected folder at random.

### **Searching a File to Be Played Back**

#### **“Media Player”**

1. Press [Options] and select “Search”.
2. Enter the first few letters of the title.

Search results are displayed in alphabetical order and the matching file is highlighted.

### **Adding a File to the Playlist**

You can create a playlist registering desired files.

#### **“Media Player”**

1. Highlight the file you wish to add to the playlist.



## Media Player

---

**2. Press [Options] and select “Add to Playlist”.**

The playlists are displayed. For details on adding a playlist, see “Adding a New Playlist” on page 113.

**3. Select the desired folder.**

**4. Press .**

The file highlighted in step 1 is saved.

To delete the playlist, highlight the playlist and press [Options]. Then select “Delete Playlist”.

### Streaming

You can play back sound files while downloading them from the mobile network.

You can also register the address of the Web site as a bookmark.

#### **“Media Player”**

**1. Press [Options] and select “Streaming”.**

**2. Select from “Enter URI”, “Favourites” or “Access Log”.**

“Enter URI”: Enter the desired address of the Web site. The browser opens, starts downloading and plays back.

“Favourites”: The address of the Web site is registered.

“Access Log”: Shows the logs of the Web site you accessed. From the log you can start streaming.

### Adding a New Playlist



#### *“Media Player”*

1. Press [Options] and select “Open Music”.
2. Select “Handset Memory” or “Memory Card”.
3. Press [Options] and select “Add New Playlist”.
4. Enter the desired playlist name.
5. Press .

### Video Player

#### Playing Back Video Clip Files

##### *“Media Player”*

1. Select the desired file.  
To pause playback, press .  
To stop playback, press .

#### **Tip**

- You can create your playlist listing only the desired files (p. 115).

### Searching a File to Be Played Back

#### *“Media Player”*

1. Press [Options] and select “Search”.
2. Enter the first few letters of the title.

Search results are displayed in alphabetical order and the matching file is highlighted.

### Adding a File to the Playlist

You can create a playlist registering desired files.

#### *“Media Player”*

1. Highlight the file you wish to add to the playlist.
2. Press [Options] and select “Add to Playlist”.  
The playlists are displayed. For details on creating a playlist, see “Adding a New Playlist” on page 115.
3. Select the desired folder.
4. Press .

The file highlighted in step 1 is saved.

To delete files from the playlist, highlight the playlist and press [Options]. Then select “Delete from Playlist”.

**Streaming**

You can play back video clip files while downloading them from the mobile network.

You can also register the address of the Web site as a bookmark.

***“Media Player”***

1. Press [Options] and select “Streaming”.
2. Select from “Enter URI”, “Favourites”, “Access Log” or “Display Size”.

“Enter URI”: Enter the desired address of the Web site. The browser opens, starts downloading and plays back.

“Favourites”: The address of the Web site is registered.

“Access Log”: Shows the logs of the Web site you accessed. From the log you can start streaming.

“Display Size”: Select the display size when playing back video clip files.

**Adding a New Playlist*****“Media Player”***

1. Press [Options] and select “Open Video”.
2. Select “Handset Memory” or “Memory Card”.
3. Press [Options] and select “Add New Playlist”.
4. Enter the desired playlist name.
5. Press .

### Editing the Video Clip File

#### *“Media Player”*

1. Select the file you wish to edit.
2. Press [Options] and select “Edit”.
3. Select the desired option.
  - “Crop”: Select the desired area to be cropped.
  - “Subtitle”: Create a subtitle to add to the file.

### Backlight

#### *“Media Player”*

1. Select the file the backlight of which you wish to adjust.
2. Press [Options] and select “Settings”.
3. Select “Backlight:”.
4. Select from “Always On”, “Always Off” or “Normal Settings”.
  - “Always On”: Lit while the file is played back.
  - “Always Off”: Unlit while the file is played back even if a key is pressed.
  - “Normal Settings”: Works with the main backlight setting (p. 181).

## My Items (M 6)

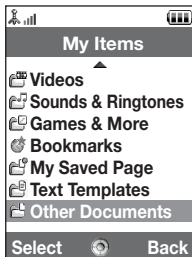
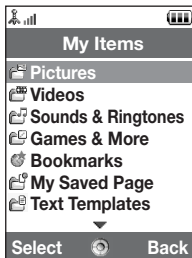

My Items contains several types of picture, sound and video clip data. Also included in My Items are frequently used text message phrases and accessed WAP pages (addresses) which you can use. You can also transmit picture, sound and video clip data via infrared or *Bluetooth* wireless technology to OBEX-enabled phones.

### Pictures (M 6–1)

Pictures that are taken by a digital camera or images that are downloaded from mobile Internet sites can be managed. You can register pictures in the following formats: JPEG, PNG, WBMP and GIF.

#### Viewing Pictures

**“My Items” → “Pictures”**

1. Select the file you wish to view.

The selected picture is displayed.

#### Switching the Memory Source

**“My Items” → “Pictures”**

1. Press .

The tab switches and the list is displayed from the memory card. To go back to the handset memory, press .

2. Select the picture file you wish to view.

#### Using Images as Wallpaper

**“My Items” → “Pictures”**

1. Highlight the file you wish to use as wallpaper.
2. Press [Options] and select “Set as Wallpaper”.

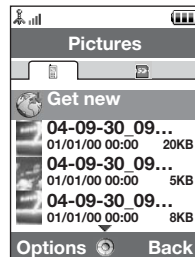

**Saving an Image to Contacts List Entries**

You can use this option only for pictures saved in the handset memory.

***“My Items”* → *“Pictures”***

1. Highlight the file you wish to add to Contacts List.

2. Press [Options] and select “Add to Contact”.

To overwrite, select the data you wish to save.

To save as a new entry, select “As New Contact”.

For details on entering a name, see “Add New Contact” on page 61.

**Editing Pictures*****“My Items”* → *“Pictures”***

1. Highlight the file you wish to edit.

2. Press [Options] and select “Picture Editor”.

3. Select the desired option.

**Note**

- *The size of pictures that you can retouch is 52 dots [W] × 52 dots [H] minimum.*



### Adjusting the Size

You can adjust the picture to an appropriate size depending on the scene.

**“My Items”** → **“Pictures”**

1. Highlight the file you wish to adjust the size of.
2. Press [Options] and select “Resize”.
3. Select the desired option.

Each option resizes the picture for each use.

“To Wallpaper”

“Power On/Off”

“For Incoming Call”

“Alarm”

“Cut”

### Note

- “Resize” may not be available depending on the original picture and copyright issued.

### **Sending a Picture File**

#### ***“My Items” → “Pictures”***

1. Highlight the file you wish to send.
2. Press [Options] and select “Send”.
3. Select the desired option.

For details on creating a message, see “Creating a New Message” on page 87.

#### **Note**

- *The Postcard service is not available with some service providers. Please contact your service provider for more information.*
- *Some pictures protected with a copyright may not be sent attached to a message.*

### **Operating the Files**

You can copy, move, sort, rename, and delete the saved pictures.

#### ***“My Items” → “Pictures”***

1. Highlight the desired file.
2. Press [Options] and select “Advanced”.

Select the desired option according to your purpose.

“Move”: Moves the files to another folder. Select the desired folder to move.

“Copy”: Copies the file. Select the desired folder to copy.

“Create Folder”: Creates a new folder.

## My Items

---

### Using Multiple Select

You can select more than one file for moving, copying and deleting.

#### Note

*The following procedure applies when the entries other than "Get new" are highlighted.*

**"My Items" → "Pictures" → [Options] → "Advanced" → "Multiple Select"**

1. Select the desired file names.
2. Press [Options] and select the desired menu.

If you select "Delete", a confirmation message is displayed.

#### Tip

- To remove the check, select the file again or select "Unselect" in step 2.
- If you wish to select all files, select "Select All" in step 2. To unselect all, select "Unselect All". Then press [Options] to select the desired menu.

To Sort the Files

#### Note

*The following procedure applies when the entries other than "Get new" are highlighted.*

**"My Items" → "Pictures" → [Options] → "Advanced" → "Sort"**

1. Select the desired order.

To Rename the File

**"My Items" → "Pictures"**

1. Highlight the desired file.
2. Press [Options] and select "Rename".

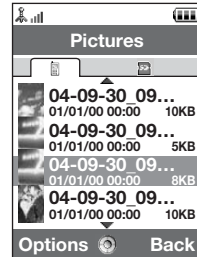

To Delete the File

**“My Items”** → **“Pictures”**

1. Highlight the desired file.
2. Press [Options] and select “Delete”.

To See the Picture Details

**“My Items”** → **“Pictures”**

1. Highlight the file of which you wish to view the detail information.
2. Press [Options] and select “Details”.

### **Uploading Picture Files**

You can upload your pictures to the live! Studio.

#### **Note**

- *This service is not available with some service providers. Please contact your service provider for more information.*

**“My Items”** → **“Pictures”**

1. Highlight the file you wish to upload.
2. Press [Options] and select “Send”.
3. Select “To live! Studio”.

#### **Note**

- *Pictures protected with a copyright cannot be uploaded, with the exception of Separate Delivery files.*

## My Items

---

### Downloading Picture Files

**“My Items”** → **“Pictures”** → **“Get new”**

The picture file download site is displayed.

#### Tip



- For details on transmitting My Items data, see “Sending My Items Data” on page 137.

### Videos (M 6–2)

Video clips that are recorded by a video camera or video clips that are downloaded from mobile Internet sites can be managed.



#### Playing Back Video Clip Files

**“My Items”** → **“Videos”**

1. Select the file you wish to play back.
2. Press .  
To resume, press  again.  
To stop playback, press [Back].

#### Switching the Memory Source

**“My Items”** → **“Videos”**

1. Press .  
The tab switches and the list is displayed from the memory card. To go back to the handset memory, press .
2. Select the video clip you wish to view.

### **Sending a Video Clip File**

#### **“My Items” → “Videos”**

1. Highlight the file you wish to send.
2. Press [Options] and select “Send”.
3. Select the desired option.

For details on creating a message, see “Creating a New Message” on page 87.

#### **Note**

- *Video clips protected with a copyright cannot be sent attached to a message, with the exception of Separate Delivery files.*

### **To Record a Video**

You can record a video also from My Items.

#### **Note**

- *The following procedure applies when the entries other than “Get new” are highlighted.*

#### **“My Items” → “Videos” → [Options] → “Record Video”**

The video camera application launches. To record a video, see “Recording Video Clips” on page 80.

### **Operating the Files**

You can copy, move, sort, rename, and delete the saved video clips.

#### **“My Items” → “Videos”**

1. Highlight the desired file.

## My Items

---

### 2. Press [Options] and select “Advanced”.

Select the desired option according to your purpose.

“Move”: Moves the files to another folder. Select the desired folder to move.

“Copy”: Copies the file. Select the desired folder to copy.

“Create Folder”: Creates a new folder.

### Using Multiple Select

You can select more than one file for moving, copying and deleting.

#### **Note**

- *The following procedure applies when the entries other than “Get new” are highlighted.*

**“My Items” → “Videos” → [Options] → “Advanced” → “Multiple Select”**

#### 1. Select the desired file names.

#### 2. Press [Options] and select the desired menu.

If you select “Delete”, a confirmation message is displayed.

#### **Tip**

- *To remove the check, select the file again or select “Unselect” in step 2.*
- *If you wish to select all files, select “Select All” in step 2. To unselect all, select “Unselect All”. Then press [Options] to select the desired menu.*

To Sort the Files

**Note**

- *The following procedure applies when the entries other than “Get new” are highlighted.*

**“My Items” → “Videos” → [Options] → “Advanced” → “Sort”**

1. Select the desired order.

To Rename the File

**“My Items” → “Videos”**

1. Highlight the desired file.
2. Press [Options] and select “Rename”.

To Delete the File

**“My Items” → “Videos”**

1. Highlight the desired file.
2. Press [Options] and select “Delete”.

To See the Video Clip Details

**“My Items” → “Videos”**

1. Highlight the file of which you wish to view the detail information.
2. Press [Options] and select “Details”.



## My Items

---

### Uploading Video Clip Files

You can upload your video clips to the live! Studio.

#### **Note**

- *This service is not available with some service providers. Please contact your service provider for more information.*

#### **“My Items” → “Videos”**

1. Highlight the file you wish to upload.
2. Press [Options] and select “Send”.
3. Select “To live! Studio”.

#### **Note**

- *Video clips protected with a copyright cannot be uploaded, with the exception of Separate Delivery files.*

### Downloading Video Clip Files

#### **“My Items” → “Videos” → “Get new”**

The video clip file download site is displayed.

### Setting a Ring Video

You can set your video clip to play back when the phone rings.

#### **“My Items” → “Videos”**

1. Highlight the desired video clip.
2. Press [Options] and select “Set as Ring Video”.

## Sounds & Ringtones (M 6–3)

The downloaded sound files and the AMR data recorded by Voice Recorder are managed in Sounds & Ringtones. The default ringtones are not contained within Sounds & Ringtones. Only the sound files you can play back with the phone are stored in Sounds & Ringtones.

### Playing Back Sound Files

**“My Items”** → **“Sounds & Ringtones”**

1. Select the file you wish to play back.

To stop playback, press .

### Note

- This option may not be available in all regions.

### Switching the Memory Source

**“My Items”** → **“Sounds & Ringtones”**

1. Press .

The tab switches and the list is displayed from the memory card. To go back to the handset memory, press .

2. Select the desired sound file.

### Using the Sound Files as a Ringtone

#### **“My Items”** → **“Sounds & Ringtones”**

1. Highlight the file you wish to use as a ringtone.
2. Press [Options] and select “Set as Ringtone”.

#### **Note**

- *The formats that can be used for ringtones are SMAF, MIDI (SMF, SP–MIDI), MP3, MP4 and XMF. Other formats cannot be used.*

### Sending a Sound File

#### **“My Items”** → **“Sounds & Ringtones”**

1. Highlight the file you wish to send.
2. Press [Options] and select “Send”.
3. Select the desired option.

For details on creating a message, see “Creating a New Message” on page 87.

#### **Note**

- *Sounds protected with a copyright cannot be sent attached to a message, with the exception of Separate Delivery files.*

### Operating the Files

You can copy, move, sort, rename, and delete the saved sound files.

#### **“My Items” → “Sounds & Ringtones”**

1. Highlight the desired file.
2. Press [Options] and select “Advanced”.

Select the desired option according to your purpose.

- “Move”: Moves the files to another folder. Select the desired folder to move.
- “Copy”: Copies the file. Select the desired folder to copy.
- “Create Folder”: Creates a new folder.

### Using Multiple Select

You can select more than one file for moving, copying and deleting.

#### **Note**

- The following procedure applies when the entries other than “Get new” are highlighted.

#### **“My Items” → “Sounds & Ringtones” → [Options] → “Advanced” → “Multiple Select”**

1. Select the desired file names.
2. Press [Options] and select the desired menu.  
If you select “Delete”, a confirmation message is displayed.

#### **Tip**

- To remove the check, select the file again or select “Unselect” in step 2.
- If you wish to select all files, select “Select All” in step 2. To unselect all, select “Unselect All”. Then press [Options] to select the desired menu.

## My Items

---

To Sort the Files

### **Note**

- *The following procedure applies when the entries other than “Get new” are highlighted.*

**“My Items” → “Sounds & Ringtones” → [Options] → “Advanced” → “Sort”**

1. Select the desired order.

To Rename the File

**“My Items” → “Sounds & Ringtones”**

1. Highlight the desired file.
2. Press [Options] and select “Rename”.

To Delete the File

**“My Items” → “Sounds & Ringtones”**

1. Highlight the desired file.
2. Press [Options] and select “Delete”.

To See the Sound Details

**“My Items” → “Sounds & Ringtones”**

1. Highlight the file of which you wish to view the detail information.
2. Press [Options] and select “Details”.

### Uploading Sound Files

You can upload your sounds to the live! Studio.

#### **Note**

- *This service is not available with some service providers. Please contact your service provider for more information.*

#### **“My Items” → “Sounds & Ringtones”**

1. Highlight the file you wish to upload.
2. Press [Options] and select “Send”.
3. Select “To live! Studio”.

#### **Note**

- *Sounds protected with a copyright cannot be uploaded, with the exception of Separate Delivery files.*

### Downloading Sound Files

#### **“My Items” → “Sounds & Ringtones” → “Get new”**

The sound file download site is displayed.

### Games & More (M 6–4)

Along with the preloaded application, downloaded applications are saved in Applications.

#### Using Applications

Various kinds of Vodafone specific applications can be used on this phone.

To use applications, download the applications via the mobile Internet.

Some applications offer the ability to connect to a network either within a game or a network based application.

#### Note

- *Applications may be both localised (no connectivity) and network based (using the mobile Internet to update information/play games). The network may charge you more for using network-based applications. Please contact your service provider for more information.*

#### Downloading Applications

##### Confirmation Screen

Before downloading the application you are asked to confirm what you are about to receive.

After checking the information on the confirmation screen, the application can be downloaded.

#### Note

- *User authentication may be required before downloading the application on some information screens.*

### Executing Applications

#### ***“My Items” → “Games & More”***

Downloaded applications are sequentially displayed from the latest one.

1. Select the title of the application you wish to execute.

The selected application is executed. When using network connection type applications, connection to the network can be selected.

2. To end the application, press  and select “End”.

### To Set a Screensaver Application

#### ***“My Items” → “Games & More”***

1. Highlight the desired screensaver application.

2. Press .

The confirmation screen to set a screensaver is displayed.

3. Select [Yes].





### More Games

**“My Items” → “Games & More” → “More Games”**

1. Select the application you wish to download.

The confirmation screen is displayed after various WAP browser screens.

2. Press  to start downloading.
3. Press  when finished.

### Activating Files with Copyright Protection (DRM)

Some pictures, sound files, and video clips have a digital copy protection program, which is called DRM (Digital Rights Management). You need to activate the digital licence permission to open the files. Files protected with DRM are displayed with .

**“My Items”**

1. Select the desired menu from “Pictures”, “Sounds & Ringtones” or “Videos”.
2. Highlight the file you wish to activate.
3. Press [Options] and select “Activate”.

### Note

- *Some pictures with DRM may not open even when an attempt is made to activate it.*
- *Pictures with DRM cannot be sent attached to a message, with the exception of Separate Delivery files.*

### **Sending My Items Data**

Choose the appropriate menu.

**“My Items” → “Pictures”**

**“My Items” → “Sounds & Ringtones”**

**“My Items” → “Videos”**

**“My Items” → “Other Documents”**

1. Highlight the desired file.
2. Press [Options] and select “Send”.
3. Select “Via Bluetooth” or “Via Infrared”.

For “Via Bluetooth”

For details, see “Bluetooth” on page 206.

For “Via Infrared”

For details, see “Infrared” on page 212.

#### **Note**

- *Pictures/Sounds/Video clips protected with a copyright cannot be sent, with the exception of Separate Delivery files.*
- *When pairing, you need to enter your passcode when establishing contact with a Bluetooth wireless technology enabled device for the first time.*

## My Items

---

### Receiving the My Items Data

When the phone receives the My Items data, a confirmation message is displayed during stand-by.

1. Press [Yes].

The received data is saved in the corresponding My Items folder.

### Tip

- For details on Infrared or Bluetooth wireless settings, see “Connectivity” on page 206.

### Bookmarks (M 6–5)

You can store desired (or frequently used) pages (addresses) in Bookmarks. It can save you time in accessing WAP pages. For details, see “Vodafone live!” on page 105.

**“My Items” → “Bookmarks”**

1. Select the page you wish to browse.

### My Saved Page (M 6–6)

You can save the WAP page as a screenshot.

**“My Items” → “My Saved Page”**

1. Select the desired file to view.

## Text Templates (M 6–7)

You can register up to 50 text templates for use in text messages and multimedia messages. The maximum capacity of the text templates is 100 KB.

### Adding Phrases to Text Templates

***“My Items”*** → ***“Text Templates”*** → ***“Add New Template”***

1. Enter the text and press .

### Editing Text Templates

***“My Items”*** → ***“Text Templates”***

1. Highlight the text template you wish to edit.
2. Press [Options] and select “Edit”.
3. Modify the text and press .

### Viewing Text Templates

***“My Items”*** → ***“Text Templates”***

The list of Text Templates is displayed.

1. Highlight the text template you wish to view.
2. Press [Options] and select “View”.

### Deleting Text Templates

***“My Items”*** → ***“Text Templates”***

1. Highlight the text template you wish to delete.
2. Press [Options] and select “Delete”.

### **Sending Text Templates**

#### ***“My Items” → “Text Templates”***

1. Highlight the text template you wish to send.
2. Press [Options] and select “Send Template”.

### **Other Documents (M 6–8)**

Some types of files excluding picture files are stored in the Other Documents folder of the phone. You can edit and use these files as My Items data.

#### **Opening the Document File**

##### ***“My Items” → “Other Documents”***

1. Select the desired file.

#### **Sending the Document File**

##### ***“My Items” → “Other Documents”***

1. Highlight the file you wish to send.
2. Press [Options] and select “Send”.
3. Select the desired option.

### Operating the Files

You can copy, move, rename, sort, rename, and delete the saved documents.

#### ***“My Items” → “Other Documents”***

1. Highlight the desired file.
2. Press [Options] and select “Advanced”.

Select the desired option according to your purpose.

“Move”: Moves the files to another folder. Select the desired folder to move.

“Copy”: Copies the file. Select the desired folder to copy.

“Create Folder”: Creates a new folder.

### Using Multiple Select

You can select more than one file for moving, copying and deleting.

#### ***“My Items” → “Other Documents” → [Options] → “Advanced” → “Multiple Select”***

1. Select the desired file names.
2. Press [Options] and select the desired menu.  
If you select “Delete”, a confirmation message is displayed.

#### ***Tip***

- *To remove the check, select the file again or select “Unselect” in step 2.*
- *If you wish to select all files, select “Select All” in step 2. To unselect all, select “Unselect All”. Then press [Options] to select the desired menu.*

## My Items

---

To Sort the Files

***“My Items”*** → ***“Other Documents”*** → **[Options]** → ***“Advanced”*** → ***“Sort”***

1. Select the desired order.

To Rename the File

***“My Items”*** → ***“Other Documents”***

1. Highlight the desired file.
2. Press [Options] and select “Rename”.

To Delete the File

***“My Items”*** → ***“Other Documents”***

1. Highlight the desired file.
2. Press [Options] and select “Delete”.

To See the Document Details

***“My Items”*** → ***“Other Documents”***

1. Highlight the file of which you wish to view the detail information.
2. Press [Options] and select “Details”.

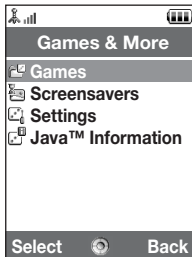

### Games (M 1-1)

The list of Java™ applications is displayed.

Downloaded applications are displayed in order starting from the latest one.

#### Executing Applications

For details on executing applications, see “Executing Applications” on page 135.

#### Setting Security Level

You can set the security level for selected Java™ applications.

**“Games & More” → “Games”**

1. Highlight the desired Java™ application.
2. Press [Options] and select “Security Level”.
3. Select one of the following options:

“Network Access”: Sets security to access the network.

“Messaging”: Sets security to perform MMS and SMS messaging.

“Auto Run”: Sets security to perform the Auto Run function.

“Local Connection”: Sets security to access local contents.

“Read User Data”: Sets security to read user data, such as Contacts List entries, mailbox (Inbox) and My Items data.



## Games & More

---

- “Write User Data”: Sets security to write entries in your phone, such as Contacts List entries, mailbox (Inbox) and My Items data.
- “Use Multimedia”: Sets security to use the barcode scanning function.
- “Location Access”: Sets security to update the positioning function.
- “Reset”: Clears all the above settings.

#### 4. Select one of the following options:

- “Session”: The confirmation message is not displayed until you exit the application, while execution of the API of the specified function group is authorised.
- “Oneshot”: The confirmation message is displayed every time the API of the specified function group is executed.
- “Blanket”: The confirmation message is not displayed until the application is deleted or you change the settings, while execution of the API of the specified function group is authorised.
- “No”: Execution of the API of the specified function group is not authorised.

### Setting Network Access

In order to download Java™ applications, you need to set the network access.

***“Games & More” → “Games” → [Options] → “Security Level” → “Network Access”***

1. Select “Session”, “Oneshot”, “Blanket” or “No”.

### Viewing Application Information

You can check the information of Java™ applications.

**“Games & More”** → **“Games”**

1. Highlight the desired Java™ application.
2. Press [Options] and select “Information”.

### Deleting an Application

You can delete an application from the handset memory.

**“Games & More”** → **“Games”**

1. Highlight the desired Java™ application.
2. Press [Options] and select “Delete”.

### Screensavers (M 1–2)

You can download screensaver applications for the stand-by screen.

#### Switching the Screensaver On or Off

**“Games & More”** → **“Screensavers”** → **“Switch On/Off”**

1. Select “On” or “Off”.

#### Note

- If you select “On” and a screensaver application is not set, a list displaying available screensavers is displayed, asking you to make a selection.

### Set Applications

***“Games & More” → “Screensavers” → “Set Applications”***

The downloaded applications are displayed.

1. Select the desired screensaver application.





### Settings (M 1–3)

#### Application Volume

You can set the volume of the application such as the sound effect to one of the five levels or silent. When “Application Volume” is set to “Silent”, this setup has priority.

***“Games & More” → “Settings” → “Application Volume”***

The current volume level is displayed.

1. Press  (or ) to increase the volume or press  (or ) to decrease the volume and then press .

#### Backlight

***“Games & More” → “Settings” → “Backlight” → “Switch On/Off”***

1. Select from “Always On”, “Always Off” or “Normal Settings”.

“Always On”: Lit while the application is operated. Blinks when the blink setting is on.

“Always Off”: Unlit while the application is operated even if a key is pressed.

“Normal Settings”: Works with the main backlight setting (p. 181). Blinks when the blink setting is on.

### To Set the Blinking Operation

This setting enables the backlight to be controlled by the application. If set to "Off", the backlight cannot be turned on from the application.

**"Games & More" → "Settings" → "Backlight" → "Blink"**

1. Select "On" or "Off".

### Vibration

When the vibrator is set in the application, you can choose whether the operation is enabled or disabled.

When a SMAF file is specified in the application, you can operate the vibrator set in the SMAF file.

### Note

- SMAF (*Synthetic music Mobile Application Format*) is a music data format for mobile phones.

**"Games & More" → "Settings" → "Vibration"**

1. Select from "On", "Link to Sound" or "Off".

When you set "Link to Sound", the vibration is synchronised with the sound of SMAF file in the application.



### Calls & Alarms

You can set the priority of incoming calls and alarms while an application is operating.

**“Games & More” → “Settings” → “Calls & Alarms”**

**1.** Select “Incoming Call”, “Video Call”, “Incoming Message” or “Alarm”.

**2.** Select the desired method.

- “Call Priority”, “Message Priority” or “Alarm Priority”:  
The application is suspended automatically, and you can receive a call or a message, or the alarm will sound. After finishing the call or the message, or the alarm ends, the suspend indicator (  ) is displayed letting you know there is a suspended application.
- “Call Notice”, “Message Notice” or “Alarm Notice”:  
The marquee (character scrolls) is displayed on the first line of the screen while the application continues. If you press , the application is suspended, and you can receive a call or a message. After finishing the call or the message, the suspend indicator (  ) is displayed letting you know there is a suspended application.

### Java™ Information (M 1–4)

The information about the licences belonging to Java™ is displayed.

### Calendar (M 7–1)

Calendar allows you to easily schedule appointments or events, which are associated with the date and time.

These entries can also be sent via infrared or *Bluetooth* wireless technology to a PC to share the same schedules. When you exchange entries with other devices, the date and time displayed may be different to that of the original data depending on the data format of the receiving device.

#### Creating a New Entry

**“Organiser” → “Calendar”**

1. Select the desired day to which you want to add an event.
2. Select “Add New Entry”.
3. Enter the subject.
4. Enter the location.
5. Select the desired category.
6. Enter the start date and then enter the start time.
7. Select the duration.
8. Select the reminder time or date.

## Organiser

---

9. Select “Repeat” and select the desired option.
10. Select “Description” and enter a memo for the schedule entry.
11. Select “Secret” and select “On” or “Off” to make it secret data.
12. Press [Save].

### **Note**

- *If the date and time settings have not been made, the date and time entry screen is displayed (p. 185).*
- *The reminder will not sound when “Ringer Volume” (p. 172) is set to “Silent”.*

### **Sending a Schedule Entry**

#### **“Organiser” → “Calendar”**

1. Select the day including schedule entries you wish to send.
2. Press [Options] and select “Send”.
3. Select “As Message”, “Via Bluetooth” or “Via Infrared”.

For “Via Bluetooth”

For details, see “Bluetooth” on page 206.

For “Via Infrared”

For details, see “Infrared” on page 212.

### **Note**

- *When pairing, you need to enter your passcode when establishing contact with a Bluetooth wireless technology enabled device for the first time.*

### Receiving a Schedule Entry

When the phone receives a schedule entry, a confirmation message is displayed during stand-by.

**1. Press [Yes].**

The received entry is saved in the Calendar.

Press [No] to reject.

#### Tip

- For details on making Infrared or Bluetooth wireless settings, see “Connectivity” on page 206.

### Viewing a Schedule Entry

“Organiser” → “Calendar”

**1. Select the day you wish to view.**

The daily view is displayed.

To Search By Date

**1. In the monthly or daily view, press [Options] and select “Go to”.**

**2. Select “Today” to display today or “Enter Date” to enter the desired date.**

### Editing a Schedule Entry

“Organiser” → “Calendar”

**1. Select the day you wish to edit.**

The daily view is displayed.





## Organiser

---

2. Press [Options] and select “Edit”.
3. Select the desired item and modify the entry.
4. Press [Save].

### Deleting Schedule Entries

1. In the monthly or daily view, press [Options] and select “Delete”.
2. Select the desired option.

“This Appointment” (daily view only):

Deletes the selected appointment.

“All This Day”: Deletes all entries for the selected day.

“All This Month” (monthly view only):

Deletes all entries for the selected month.

“Up to Last Month” (monthly view only):

Deletes all entries before this month.

“All Appointments” (monthly view only):

Deletes all entries in this application.

### Viewing the Memory Status

1. In the monthly or daily view, press [Options] and select “Memory Status”.  
The current memory status is displayed.

## Alarms (M 7–2)

### Setting the Alarms

The alarm function allows you to be alerted at a specified time.

Note that you need to set the current date and time before setting the alarm function if it has not been done already.

#### **Note**

- *The alarm will not ring when “Ringer Volume” (p. 172) is set to “Silent”.*

#### **“Organiser” → “Alarms”**

1. Select the blank setting.
2. Enter the desired time.
3. Select the repeat option.

#### To Change the Type of Alarm Tone

1. On the Set Alarm screen, select “Assign Tone/Video”.
2. Select “Assign Alarm Tone”.
3. Select “Preset Sounds” or “My Sounds”.
4. Select the desired tone.

For details on selecting a tone, see “Assigning a Ringtone” on page 173.





### To Change the Type of Video

1. On the Set Alarm screen, select “Assign Tone/Video”.
2. Select “Assign Alarm Video”.
3. Select the desired video.

### To Change the Snooze of the Alarm Tone

1. On the Set Alarm screen, select “Snooze”.
2. Select the desired snooze option.

### To Change the Alarm Volume

1. On the Set Alarm screen, select “Alarm Volume”.
2. Press  (or ) to increase the volume or press  (or ) to decrease the volume.

### To Change the Vibration of Alarm Tone

1. On the Set Alarm screen, select “Vibration”.
2. Select “On”, “Link to Sound” or “Off”.

For details on selecting a vibration, see “Vibration” on page 176.

### To Change the Duration of the Alarm Tone

1. On the Set Alarm screen, select “Duration”.
2. Select the desired duration.



### Resetting an Alarm Setting

**“Organiser”** → **“Alarms”**

1. Highlight the alarm you wish to reset.
2. Press [Options] and select “Reset Alarm”.

### Resetting All Alarm Settings

**“Organiser”** → **“Alarms”** → **“Clear All”**

### Calculator (M 7–3)

The calculator function performs the 4 arithmetic calculations using up to 12 digits.

**“Organiser”** → **“Calculator”**

The calculator is displayed on the display.

Key operations for calculation are as follows:

To enter a decimal point, press  $\boxed{X \cdot}$ .

To clear the entered number or function, press  $\boxed{C:CE}$ .

To do the calculations, press  $\boxed{=}$ .

To start a new calculation, press  $\boxed{MC}$ .

## Organiser

---

### Rate Conversion

You can also use the calculator as a currency calculator to convert from/to a home currency using a conversion rate that you enter.

To Set a Currency Conversion Rate

***“Organiser” → “Calculator” → [Options] → “Currency Converter” → “Exchange Rate”***

1. Select “Domestic” or “Foreign”.
2. Enter the currency conversion rate.

To delete a digit, press .

To Convert a Value

***“Organiser” → “Calculator”***

1. Enter the value to be converted.
2. Press [Options] and select “Currency Converter”.
3. Select “Convert to Domestic” or “Convert to Foreign”.



The result is displayed.

## Voice Recorder (M 7–4)



This allows you to record a voice clip, which can be used to remind you of schedule entries or be sent within a multimedia message. The recorded voice clip is saved in Saved Sounds. Voice clips are saved in .amr format.

### Recording a Voice Clip

#### “Organiser” → “Voice Recorder”



1. Press  to start recording.  
To stop recording before the recording time is over, press .
2. Select “Save” to save the voice clip.

#### Note

- Press  (or the side–up key) or  (or the side–down key) to adjust the sound volume when playing back the recorded file.

### Sending Voice Clips

#### “Organiser” → “Voice Recorder”

1. Press  to start recording.
2. Press  to stop recording.
3. Select “Save and Send”.

For details on creating a message, see “Creating a New Message” on page 87.

## Organiser

---

### Viewing Record Time

**“Organiser”** → **“Voice Recorder”** → **[Options]** → **“Record Time”**

1. Select “For Message” or “Extended Voice”.

When selecting “Extended Voice”, you can save the voice clip only in a memory card automatically.

### Selecting Storage Memory

**“Organiser”** → **“Voice Recorder”** → **[Options]** → **“Save Recording To”**

1. Select the desired location.

When selecting “Choice”, you can select the location when saving a voice clip.

## Scanner (M 7–5)

With the built-in digital camera, you can read texts and barcodes in Jan format and QR codes, and create QR codes. The scanned data can be saved as a Contacts List entry, URL, email address and text.

### Note

- *When scanning does not place it may be for one of the following reasons: type or size of barcode, scratches, dirt, damage, print quality, light reflection, etc.*

### Reading Barcodes

**“Organiser”** → **“Scanner”** → **“Scan Barcode”**

1. Display the barcode using the external camera.
2. Press .

The scanning starts and the scanned result is displayed.

### 3. Select the desired option.

The options vary depending on the scanned data.

“Open Link”: The browser opens the URL.

“Copy URL”: The URL is copied.

“Send Message”: The result is sent as SMS or MMS.

“Copy”: The result is copied.

### Using the Scanning Options

#### 1. In the scanning mode, press [Options] and select the desired option.

“Scan” Scanning is performed.

“Saved Files” The saved files are displayed.

“Auto Focus”: Select the focusing option from “Normal”, “Macro” or “Manual Focus”.

“Continuous Scan”: The continuous scanning is turned on.

“Mobile Light”: The mobile light is turned on or off.

“Exposure”: The exposure is adjusted in the following steps: +2, +1, 0, -1, -2.

“Help”: The Help for using the scan function is displayed.



### Creating QR Codes

You can create QR codes using texts and My Items data.

**“Organiser” → “Scanner” → “Create QR Code”**

1. Select the desired option.

“Text Input”: Create a QR code using the text you enter.

“My Items”: Create a QR code using the My Items data.

2. Press .

Creation of the barcode starts and is displayed on the screen.





3. Press .

#### Tip

- You can save the QR code in PNG format. Press [Options] and select “Save”.

### Scanning Texts

**“Organiser” → “Scanner” → “Scan Text”**

1. Display the text using the external camera.
2. When the bar under the scanned text is blue, press .
- The scanning starts and the scanned result is displayed.
3. Press  or  to select the desired text.
4. Press .

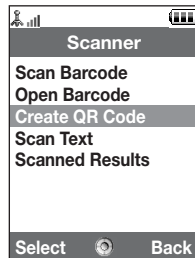

**5. Press [Options] and select the desired option.**

“OK”:	The scanned result is in the text entry screen.
“Select/Edit”:	The scanned result can be modified.
“Change Mode”:	The scanned result can be converted to a web address, mail address, phone number or to roman text.

**Using the Scanning Options****1. In the scanning mode, press [Options] and select the desired option.**

“Scan”:	Scanning is performed.
“Saved Files”:	The saved files are displayed.
“Auto Focus”:	Select the focusing option from “Normal”, “Macro” or “Manual Focus”.
“Reversed Text”:	Select the desired option from “Auto”, “Normal” or “Reversed”.
“Mobile Light”:	The mobile light is turned on or off.
“Exposure”:	The brightness is adjusted in the following steps: +2, +1, 0, -1, -2.
“Help”:	The Help for using the scan function is displayed.

**Deleting the Scanned Data**

**“Organiser” → “Scanner” → “Scanned Results”**

1. Highlight the data you wish to delete.
2. Press [Options] and select “Delete”.

### Renaming the Scanned Data

**“Organiser”** → **“Scanner”** → **“Scanned Results”**

1. Highlight the data you wish to rename.
2. Press [Options] and select “Rename”.

### Checking the Information of the Scanned Data



**“Organiser”** → **“Scanner”** → **“Scanned Results”**

1. Highlight the data the information of which you wish to check.
2. Press [Options] and select “Information”.

### Stopwatch (M 7–6)

You can store 4 lap times when using the stopwatch function.

**“Organiser”** → **“Stopwatch”**

1. Press  to start.  
Press [LAP] to view the lap time before the stopwatch stops. Last 4 lap times are saved.
2. Press  to stop.

#### Tip

- You can save a record of lap time and stop time in Text Templates by pressing [Options] and selecting “Save to Templates”.

### Resetting Time

1. After stopping the stopwatch, press [Options] and select “Reset”.

## Tasks (M 7–7)

You can register your schedule as task entries which are associated with the date and time.

### Creating a New Entry

#### **“Organiser”** → **“Tasks”**

1. Select “Add New Entry”.
2. Enter the subject.
3. Enter the due date and then due time.
4. Select the reminder option.  
When selecting “Other”, enter the desired reminder date and time.
5. Select “Description” and enter a memo for the task entry.
6. Select “Secret” and select “On” or “Off” to make it a secret data.
7. Press [Save].

#### **Note**

- *If the date and time settings have not been made, the date and time entry screen is displayed (p. 185).*

### Setting the Alarms

You can set the alarm at a specified time on the entry.

#### **“Organiser”** → **“Tasks”**

1. Highlight the desired entry.
2. Press [Options] and select “Edit”.
3. Select “Reminder” and select “Reminder Time”.
4. Select the desired reminder time.

## Organiser

---

### To Change the Type of Alarm Tone

1. On the Reminder screen, select “Assign Tone/Video”.
2. Select “Assign Tone”.
3. Select “Preset Sounds” or “My Sounds”.
4. Select the desired tone.

For details on selecting a tone, see “Assigning a Ringtone” on page 173.

### To Change the Type of Video

1. On the Reminder screen, select “Assign Tone/Video”.
2. Select “Assign Video”.
3. Select the desired video clip file.

### To Change the Duration of Alarm Tone or Video

1. On the Reminder screen, select “Duration”.
2. Select the desired duration.

## Editing the Task Entry

### *“Organiser”* → *“Tasks”*

1. Highlight the desired entry.
2. Press [Options] and select “Edit”.
3. Modify the entry.

### **Sending a Task Entry**

#### ***“Organiser”* → *“Tasks”***

1. Highlight the task entry you wish to send.
2. Press [Options] and select “Send”.
3. Select the desired option.

“As Message”: Sends the entry as a message.

“Via Bluetooth”: Sends the entry through Bluetooth connection.

“Via Infrared”: Sends the entry through Infrared connection.

#### **For “Via Bluetooth”**

For details, see “Bluetooth” on page 206.

#### **For “Via Infrared”**

For details, see “Infrared” on page 212.

#### **Note**

- *When pairing, you need to enter your passcode when establishing contact with a Bluetooth wireless technology enabled device for the first time.*

### **Viewing the Memory Status**

#### ***“Organiser”* → *“Tasks”***

1. Highlight the task entry you wish to view the memory status of.
2. Press [Options] and select “Memory Status”.

The current memory status is displayed.

## Organiser

---

### Deleting Entries

***“Organiser”*** → ***“Tasks”*** → ***[Options]*** → ***“Delete”***



1. Select the desired option.

“This Task”: Deletes the selected entry.  
“All Completed Tasks”: Deletes all checked entries.  
“All Tasks”: Deletes all entries.

### World Clock (M 7–8)

#### Setting the Time Zone

***“Organiser”*** → ***“World Clock”***

1. Press [Edit].
2. Select “Set Time Zone”.  
The current time zone is indicated on the world map.
3. Press  or  to change the time zone.
4. Press .

To Set the Custom Time Zone

***“Organiser”*** → ***“World Clock”***

1. Press [Edit].
2. Select “Set Time Zone”.

The current time zone is indicated on the world map.

3. Press [Options] and select “Set Custom Zone”.
4. Enter the desired city name and time.

**Setting the Daylight Saving**

***“Organiser”*** → ***“World Clock”***

1. Press [Edit].
2. Select “Daylight Saving”.
3. Select “On” or “Off”.

**Countdown Timer (M 7–9)**

***“Organiser”*** → ***“Countdown Timer”***

1. Enter the time to count.

You can set the time from 1 second to 60 minutes.

2. Press  to start counting.
3. Press  to pause.  
Press  again to continue counting.



## Organiser

---

4. If the countdown has finished, press [Cancel] and then press  to start the countdown again.

### Editing the Countdown Time

1. In the countdown start screen, press [Options] and select “Edit”.
2. Modify the desired time.

## Expenses Memo (M 7–10)

You can record an expenses memo with predefined or edited categories.

### Recording in the Expenses Memo

**“Organiser”** → **“Expenses Memo”** → **“Add New Expense”**

1. Enter the expenses using the digit keys.
2. Select the desired category.  
Expenses memo is registered.

### Viewing Totals

**“Organiser”** → **“Expenses Memo”** → **“Totals”**

Recorded expenses are displayed on the screen.

#### To Change Amount

1. In the total view, select the desired item.
2. Press [Options] and select “Change Amount”.
3. Enter the desired amount using the digit keys.

#### To Delete a Recorded Item

1. In the total view, select the desired item.
2. Press [Options] and select “Delete Item”.  
The selected item is deleted from the list.

#### To Delete All Items

1. In the total view, select the desired item.
2. Press [Options] and select “Delete All”.

#### Editing the Category Name



***“Organiser” → “Expenses Memo” → “Edit Category”***

1. Select the desired category name.
2. Modify the name.

#### Phone Help (M 7–11)

You can view the help list and use it to guide you in the phone’s functions.

***“Organiser” → “Phone Help”***

1. Press  or .

## **SIM Application (M 9)**

---

You can refer to the information on the SIM/USIM. Contact your service provider for further details.

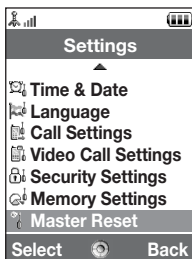
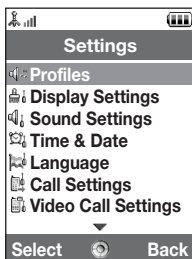

### Profiles (M 12–1)

The tone sound and vibration settings can be customised for each profile according to your environment.

There are 6 profiles: “Normal”, “Meeting”, “Activity”, “Car”, “Headset” and “Silent”.

#### Activating a Profile

“Settings” → “Profiles”

1. Select the desired profile.

#### Note

- When a profile is set, the corresponding indicator described on page 29 is displayed during stand-by.

#### Tip

- Press and hold **[M]** to switch Profiles settings between the mode most recently activated and Silent mode during stand-by.

#### Customising Profiles

“Settings” → “Profiles”

1. Highlight the profile you wish to customise.
2. Press [Options] and select “Personalise”.
3. Select the setting you wish to customise and change as desired.

For details on settings, see pages 172 to 177.

### Resetting Profile Settings

#### **“Settings”** → **“Profiles”**

1. Highlight the profile you wish to reset.
2. Press [Options] and select “Set to Default”.
3. Enter your handset code.

The default handset code is “9999”. For details on changing the handset code, see “To Change the Handset Code” on page 199.





### Ringer Volume



You can adjust the ringer volume to one of six levels or to an increasing volume.



#### **“Settings”** → **“Profiles”**

1. Highlight the profile you wish to customise.
2. Press [Options] and select “Personalise”.
3. Select “Volume”.

The current volume level is displayed.

4. Press  (or ) to increase the ringer volume or press  (or ) to decrease the ringer volume and then press .

To select “Increasing Volume”, press  (or ) at level 5.

To select “Silent”, press  (or ) at level 1.

**Tip**

- You can select from two levels or an increasing volume, when selecting the “Silent” profile.

**Assigning a Ringtone**

You can select the ringtone from 28 tones including 5 patterns, 13 sound effects and 10 melodies. You can also select a sound in Saved Sounds as the default ringtone excluding the AMR or WAVE format.

**“Settings” → “Profiles”**

1. Highlight the profile you wish to customise.
2. Press [Options] and select “Personalise”.
3. Select “Ringtone/Ringvideos”.
4. Select “For Voice Call” or “For Video Call”.
5. Select “Assign Tone”.
6. Select “Preset Sounds” or “My Sounds”.
7. Highlight the ringtone you wish to use.  
To hear the demo play, press [Options] and select “Play”.
8. Press [Options] and select “Assign”.

## Settings

---

### **Note**

- *Even if you delete a ringtone that uses a sound in Saved Sounds, the setting remains the same and the default ringtone sounds. If you delete a ringtone assigned for the ringtone, the default ringtone is set.*

### **Assigning a Ring Video Clip File**

You can select a video clip file in Saved Videos as the default ring video clip file.

#### **“Settings” → “Profiles”**

1. Highlight the profile you wish to customise.
2. Press [Options] and select “Personalise”.
3. Select “Ringtone/Ringvideos”.
4. Select “For Voice Call” or “For Video Call”.
5. Select “Assign Video”.
6. Highlight the ring video clip file you wish to use.  
To preview the file, press [Options] and select “Play”.
7. Press [Options] and select “Select”.

**Message Notification**

When receiving messages, your phone will notify you of their arrival with the ringtone or ring video you specify.

***“Settings” → “Profiles”***

1. Highlight the profile you wish to customise.
2. Press [Options] and select “Personalise”.
3. Select “Ringtone/Ringvideos”.
4. Select “For New Message”.
5. Select “Assign Tone” or “Assign Video”.

If “Assign Tone” is selected, select “Preset Sounds” or “My Sounds”.

6. Highlight the desired ringtone or ring video clip.

For details on selecting a ringtone or a ring video, see “Assigning a Ringtone” on page 173 or “Assigning a Ring Video Clip File” on page 174.

7. Press [Options] and select “Assign” (for a ringtone) or “Select” (for a video clip).
8. Select “For New Message” and select “Duration”.
9. Enter the desired duration.

**Keypad Tones**

When the keypad tone is set on, you will hear a confirmation tone each time you press any keys.

***“Settings” → “Profiles”***

1. Highlight the profile you wish to customise.
2. Press [Options] and select “Personalise”.



## Settings

---

3. Select “System Sounds”.
4. Select “Keypad Tones”.
5. Highlight the desired tone pattern.
6. Press [Options] and select “Assign”.

### Vibration

When the vibrator option is set on, the phone will vibrate for incoming calls regardless of the ringer volume and ringtone settings.

#### **“Settings” → “Profiles”**

1. Highlight the profile you wish to customise.
2. Press [Options] and select “Personalise”.
3. Select “Vibration”.
4. Select “On”, “Link to Sound” or “Off”.

### Tip

- When the “Link to Sound” option is selected in step 4, the vibrator synchronises with your selected melody to pulse in time with the melody. Please note that not all melodies support the “Link to Sound” option.
- When you select “On” or “Link to Sound” in step 4, “ ” is displayed during stand-by.

### External Light Colour

You can select from 7 colours and 1 pattern for each profile and change it during an incoming call.



#### **“Settings” → “Profiles”**

1. Highlight the profile you wish to customise.
2. Press [Options] and select “Personalise”.
3. Select “External Light”.
4. Select “For Voice Call”, “For Video Call” or “For New Message”.
5. Select the desired colour or “Off”.

#### **Tip**

- If you select “Disco” in step 5, all 7 colours flash in order during an incoming call.

### Any Key Answer

You can answer a call by pressing any key except , ,  and [Busy]. For details, see page 38.

#### **“Settings” → “Profiles”**

1. Highlight the profile you wish to customise.
2. Press [Options] and select “Personalise”.
3. Select “Any Key Answer”.
4. Select “On” or “Off”.

### Setting the Display (M 12–2)

You can change the settings of the main and sub displays.

#### Setting the Main Display

##### Wallpaper

For the stand-by screen, 5 pictures are provided.

Pictures taken with the digital camera or images downloaded from a WAP site can be used for wallpapers.

##### Setting My Pictures

**“Settings”** → **“Display Settings”** → **“Wallpaper”**

1. Select “My Pictures”.
2. Select the desired picture.
3. After displaying the picture, press .

##### Note

- Some pictures cannot be used because of their picture and data types.
- If the picture in My Pictures is already set, it is displayed in step 1. Press [Change] and select the desired picture.

### Assigning the Pictures

Pictures can be displayed when turning the power on or off, when receiving an incoming call, or when operating the alarm.

Pictures taken with the digital camera or images downloaded from a WAP site can be used.

To Set Built-in Pictures

***“Settings” → “Display Settings” → “System Graphics”***

1. Select the desired scene to set the picture to.
2. Select “Preset Animation” when you select “Power On” or “Power Off” in step 1.  
Select “Pattern 1”, “Pattern 2” or “Pattern 3” when you select “Incoming Call” or “Alarm” in step 1.

To Set My Pictures

***“Settings” → “Display Settings” → “System Graphics”***

1. Select the desired scene to set the picture to.
2. Select “My Pictures”.
3. Select the desired picture.
4. After displaying the picture, press .
5. Specify the area you wish to display using the navigation keys.

## Settings

---

### **Note**

- *Some pictures cannot be used because of their picture and data types.*
- *If the picture in My Pictures is already set, it is displayed in step 2. Press [Change] and select the desired picture.*

### **Setting the Font Weight**

You can change the font weight displayed on the screen.

**“Settings”** → **“Display Settings”** → **“Font Settings”**

1. Select “Thin”, “Normal”, “Bold” or “Bolder”.

The preview image is displayed in the selected weight.

### **Setting the Greeting Message**

You can set the message which is displayed when the phone is turned on.

**“Settings”** → **“Display Settings”** → **“Greeting Message”** → **“Switch On/Off”**

1. Select “On” or “Off”.
2. Select “Edit Message” and enter the message when you select “On” in step 1.

Up to 10 characters can be saved as a message.

### Showing the Clock

You can display the calendar or the current date and/or time during stand-by.

To Set the Clock Display

**“Settings”** → **“Display Settings”** → **“Clock & Calendar”** → **“Show Clock”**

1. Select the desired clock type or “Off” to set clock display off.

#### **Tip**

- *When you select “Calendar”, you can display one or two consecutive calendars by selecting “1 month” or “2 months”.*

### Backlight

The backlight will shut off if you do not press the keypad for a certain length of time. You can specify a desired time to elapse before the backlight shuts off, which will help conserve battery life.

#### **Tip**

- *When you purchase this phone, Backlight is set to 15 seconds.*

To Select the Backlight Time Out

**“Settings”** → **“Display Settings”** → **“Backlight”**

1. Select the desired time.  
Select “Off” to shut it off.



## Settings

---

### Adjusting the Brightness of the Backlight

You can adjust the brightness of the backlight of the screen between 4 levels.

**“Settings”** → **“Display Settings”** → **“Brightness”**

1. Press  (Light) and  (Dark) for maximum clarity.
2. Press .

### Setting the Display Saving

The screen of this phone will automatically turn off after a given amount of time. You can change the length of time before the Display Saving goes into effect, which will help conserve battery life.

#### Tip

- *When you purchase this phone, Display Saving is set to 2 minutes.*

**“Settings”** → **“Display Settings”** → **“Display Saving”**

1. Select the desired time.

#### Note

- *Display Saving does not work while you are making a call, using WAP, or using an application.*
- *To cancel the Display Saving: The display saving continues until either a key is pressed or there is an incoming alert. The first key press only cancels this function. You must press another key in order to enter any numerical or text value.*

### Setting Video Out

With the optional cable, you can connect your phone to other device, such as TVs or videos set to output, and display images or video clips stored on your phone. It is also possible to output and display data stored in the memory card.

#### To Set Output Function On

You need to connect your phone to the other device with the optional cable beforehand.

**“Settings” → “Display Settings” → “Video Output” → “Output” → “On”**

Select “Off” on the Output screen when finished.

#### Note

- *When closing your phone, you cannot output data to the connected device.*
- *It is not possible to output some images or video clips.*

#### To Select Display Size

You can display images in enlarged size.

**“Settings” → “Display Settings” → “Video Output” → “Display Size”**

1. Select “Enlarge”.

To display in original size, select “Original Size”.

#### To Rotate Image

**“Settings” → “Display Settings” → “Video Output” → “Rotate Image”**

1. Select the desired item.

The image displayed on the device will rotate until the selected degree.



## Settings

---

### To Select TV System

You need to select the appropriate TV system. Refer to the instruction manual of your connected device to confirm the TV system.

**“Settings” → “Display Settings” → “Video Output” → “TV System”**

1. Select the desired item.

### Setting the Sub Display

#### To Turn On/Off the Sub Display

You can turn the sub display on or off when the phone is closed.

**“Settings” → “Display Settings” → “Sub Display” → “Display On/Off”**

1. Select “On” to turn sub display on or “Off” to turn sub display off.

#### To Select the Backlight Time Out

**“Settings” → “Display Settings” → “Sub Display” → “Backlight”**

1. Select the desired time out.

Select “Off” to shut the backlight off.

#### To Adjust the LCD Contrast

You can adjust the LCD contrast to suit certain lighting conditions.

**“Settings” → “Display Settings” → “Sub Display” → “Contrast”**

1. Press ☀️ (Light) or 🌑 (Dark) to adjust the contrast and press ⏪.

The LCD contrast can be adjusted to 9 levels.

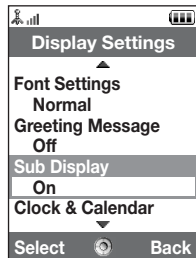

### To Set Incoming Indication

Caller number or registered caller name can be displayed on the external display when receiving an incoming call.

**“Settings”** → **“Display Settings”** → **“Sub Display”** → **“Caller Display”**

Select “On” or “Off”.

### Sound Settings (M 12–3)

You can use this menu to check or edit the current Profiles settings (except “Any Key Answer”).



### Time & Date (M 12–4)

You need to set the correct time and date in order for your phone’s various time-based functions to work correctly.

**“Settings”** → **“Time & Date”** → **“Set Date/Time”**

1. Enter the day, month and year using the digit keys.
2. Enter the time using the digit keys.

#### **Tip**

- When you enter the time in the 12-hour format, press  or  to switch between am and pm. The order in which the date and time is displayed is based on the format setting.

## Settings

---

### Selecting the Time Format

***“Settings”*** → ***“Time & Date”*** → ***“Time Format”***

1. Select “24 Hour” or “12 Hour”.

### Selecting the Date Format

***“Settings”*** → ***“Time & Date”*** → ***“Date Format”***

1. Select from “D.M.Y”, “M–D–Y” or “Y/M/D”.



### Setting the Daylight Saving

***“Settings”*** → ***“Time & Date”*** → ***“Daylight Saving”***

1. Select “On” or “Off”.



### Setting the Time Zone

***“Settings”*** → ***“Time & Date”*** → ***“Set Time Zone”***

1. Press  or  to select the home city to set.
2. Press .

### Customising the Time Zone

***“Settings”*** → ***“Time & Date”*** → ***“Set Time Zone”*** → ***[Options]*** → ***“Set Custom Zone”***

1. Enter the city name.
2. Enter the time–zone differences using the digit keys.  
Press  or  to switch between – and +.
3. Press .

### Setting the Calendar Format

**“Settings”** → **“Time & Date”** → **“Calendar Format”**

1. Select “Sunday–Saturday” or “Monday–Sunday”.

### Language Setting (M 12–5)

You can change the language that the phone uses to display messages.

**“Settings”** → **“Language”**

1. Select the desired language.

#### **Tip**

- You can also change the input language on the text entry screen (p. 55).

#### **Note**

- If you select “Automatic” in step 1, the language preset on the SIM/USIM card is selected.
- If the language preset on the SIM/USIM card is not supported, then the default language of the phone is selected.

### Call Settings (M 12–6)

Set various types of functions and services for voice calls.

#### Diverts

##### **Note**

- *This service may not be available on all mobile phone networks. Contact your network operator for more information.*

This service is used to divert incoming calls to your voice mail system or to another phone number depending on certain conditions in which you cannot answer a call.

To Divert Calls

**“Settings”** → **“Call Settings”** → **“Diverts”**

**1. Select one of the following options:**

- “All Calls”: Diverts all calls without ringing.
  - “When Busy”: Diverts incoming calls when you are talking on the phone.
  - “No Answer”: Diverts incoming calls if you do not answer a call within a certain period of time.
  - “Not Reachable”: Diverts incoming calls when your phone has no network service or is switched off.
  - “Cancel All”: Clears all the above settings.
- If you select “No Answer”, go to step 5.

**2. Select “On”.**

3. Enter a phone number to which you wish to divert calls or search for it in the Contacts List (p. 63).
4. Press .
5. Select the period of time from 6 levels (05 to 30 seconds).

**Note**

- When a divert is set to "Voice calls" of "All Calls", " " is displayed during stand-by.

**Tip**

- If you select "By Service" in step 2, you can select further divert options.

To Check the Divert Status

**"Settings" → "Call Settings" → "Diverts"**

1. Select the divert option you wish to check.
2. Select "Status".

## Settings

---

### Call Waiting

#### **Note**

- *This service may not be available on all mobile phone networks. Contact your network operator for more information.*

If you wish to be able to receive another incoming call while you have a call in progress, you must activate the Call Waiting service.

**“Settings” → “Call Settings” → “Call Waiting”**

1. Select “On”, “Off” or “Status”.

### Showing Your Phone Number

This lets you control whether to show your phone number when calling another party or not.

**“Settings” → “Call Settings” → “Show Your Number”**

1. Select “On”, “Off” or “Status”.

#### **Note**

- *Some networks do not support this service. Please check with your service provider for availability.*

### Call Information

With this setting On, the information of an incoming call is displayed.

***“Settings” → “Call Settings” → “Display Call Info”***

1. Select “On” or “Off”.

### Restrict Calls

This function lets you place restrictions on incoming and outgoing calls. To activate this option you will need the specified password, which is available from your service provider.

***“Settings” → “Call Settings” → “Restrict Calls”***

1. Select from one of the following options:

- “Outgoing Calls”: Restricts outgoing calls.
- “Fixed Dialling No.”: Restricts calls for fixed dialling numbers in the Contacts List.
- “Incoming Calls”: Restricts incoming calls.
- “Rejected Numbers”: You can register for dialling numbers to be restricted.
- “Withheld Call”: Restricts withheld calls.
- “Change N/W Password”: Changes the network password.

2. Select one of the following options:

(For “Outgoing Calls”)

- “Bar All Outgoing Calls”: Restricts all outgoing calls except emergency calls.
- “Bar International Calls”: Restricts all outgoing international calls.
- “Only Local & Home”: Restricts all outgoing international calls except to your home country.



## Settings

---

(For “Incoming Calls”)

“Bar All Incoming Calls”: Restricts all incoming calls.

“Bar if Abroad”: Restricts all incoming calls when you are outside of the coverage from your registered network operator.

### 3. Select one of the following options:

(For “Outgoing Calls” and “Incoming Calls”)

“All Services”: Restricts all services.

“Voice Calls”: Restricts all voice calls.

“Video Calls”: Restricts all video calls.

“Fax”: Restricts all fax calls.

“Messages”: Restricts all messages.

“All except msgs”: Restricts all services except messages.

4. Select “On”, “Off” or “Status”.

5. Enter the network password.

To Cancel Settings

**“Settings” → “Call Settings” → “Restrict Calls”**

1. Select “Outgoing Calls” or “Incoming Calls”.

2. Select “Cancel All”.

3. Enter the network password.

### Fixed Dialling No.

When the Fixed Dialling No. is enabled, you can only call pre-registered numbers.

To Enable Fixed Dialling No.

***“Settings”*** → ***“Call Settings”*** → ***“Restrict Calls”*** → ***“Fixed Dialling No.”*** → ***“Switch On/Off”***

1. Select “On” to enable this function.

To Add a New Name

***“Settings”*** → ***“Call Settings”*** → ***“Restrict Calls”*** → ***“Fixed Dialling No.”*** → ***“Edit Dial List”***

1. Highlight the blank entry, press [Options], then select “Add New Dial”.
2. Enter your PIN2 code.
3. Add a name and a phone number.

For details on adding a name and a phone number, see “Add New Contact” on page 61.

4. Press [Save].

### Rejecting an Incoming Call

You can register phone numbers you do not wish to answer.

To Reject the Registered Number

***“Settings”*** → ***“Call Settings”*** → ***“Restrict Calls”*** → ***“Rejected Numbers”*** → ***“Switch On/Off”***

1. Select “On” or “Off”.

## Settings

---

To Register the Rejected Number

***“Settings” → “Call Settings” → “Restrict Calls” → “Rejected Numbers” → “Set Rejecting Number”***

1. Select a blank field.
2. Enter the desired number.

### Changing the Network Password

***“Settings” → “Call Settings” → “Restrict Calls” → “Change N/W Password”***

1. Enter the old network password.
2. Enter a new network password.
3. Enter the new network password again.

If you enter the incorrect password, you are asked to enter the password again.

4. Press .

### Minute Minder

Minute Minder function informs you of your talk time by sounding a tone after every minute.

***“Settings” → “Call Settings” → “Minute Minder”***

1. Select “On” or “Off”.

### Displaying Call Timer

***“Settings” → “Call Settings” → “Display Call Timer”***

1. Select “On” or “Off”.

### Auto Redial

***“Settings” → “Call Settings” → “Auto Redial”***

1. Select “On” or “Off”.

## Video Call Settings (M 12–7)

Set various types of functions and services for video calls.

### Selecting an Image for the Alternative Image

You can select your image to be sent through the internal camera from the saved picture files.

### Turning On or Off the Speakers

***“Settings” → “Video Call Settings”***

1. Select “Loud Speaker On” to turn on the loud speakers on the back of the phone, or select “Loud Speaker Off” to turn them off.

### Selecting the Picture Quality

Select the desired incoming data format for your environment.

***“Settings” → “Video Call Settings” → “Picture Quality”***

1. Select from “Normal”, “Quality Prio.” or “Frame Rate Prio.”.  
Select “Frame Rate Prio.” to perform faster communication.

### Backlight

With this setting On, the phone’s backlight is on when making a video call.

***“Settings” → “Video Call Settings” → “Backlight”***

1. Select “On”, “As Normal Setting” or “Off”.

The “As Normal Setting” option depends on the backlight setting of the main display (p. 181).

## Settings

---

### Mute

You can mute the microphone while making a video call.

***“Settings” → “Video Call Settings” → “Mute Microphone”***

1. Select “Unmute Microphone” to cancel the mute.

### Assigning Hold Guidance Picture

You can display an image saved in the phone on your main display while you are putting a call on hold.

***“Settings” → “Video Call Settings” → “Hold Guidance Pict”***

1. Select “Preset Picture” or “My Pictures”.
2. Select the desired picture.

---

## Security (M 12–8)

### Enabling/Disabling the PIN Code

If the PIN code is enabled you are asked to enter the PIN code each time the phone is switched on. Your PIN code is registered on the SIM/USIM card and you should have been made aware of the code when you purchased the SIM/USIM card. Contact your service provider for further details.

**“Settings” → “Security Settings” → “PIN Entry” → “Switch On/Off”**

1. Select “On” to enable the PIN code or “Off” to disable.
2. Enter your PIN code.

### Note

- *If you enter the wrong PIN code three times in step 2, the SIM/USIM card will lock. To remove the lock, contact your service provider/SIM/USIM card vendor.*

### To Change the PIN Code

This allows you to change the PIN code registered on the SIM/USIM card. Before you change the PIN code, select “On” in step 1 in “Enabling/Disabling the PIN Code”.

**“Settings” → “Security Settings” → “PIN Entry” → “Change PIN”**

1. Enter the existing PIN code.
2. Enter a new PIN code.
3. Enter the new PIN code again.

## Settings

---

### Changing the PIN2 Code

The PIN2 code is used to protect certain functions in the phone such as Fixed Dialling No. and call cost limits. The following shows you how to change the PIN2 code.

***“Settings” → “Security Settings” → “Change PIN2”***

1. Enter the existing PIN2 code.
2. Enter a new PIN2 code.
3. Enter the new PIN2 code again.

### Handset Lock

The Handset Lock is an additional security feature which prevents unauthorised use of the phone or certain features.

***“Settings” → “Security Settings” → “Handset Lock”***

1. Select “On” or “Off”.
2. Enter your handset code.

The default handset code is “9999”. For details on changing the handset code, see “To Change the Handset Code” on page 199.

### To Change the Handset Code

Before you change the handset code, select “On” in step 1 in “Handset Lock”.

**“Settings” → “Security Settings” → “Change Handset Code”**

1. Enter the old handset code.
2. Enter a new handset code.
3. Enter the new handset code again.

### Phone Lock

By setting this option on, your phone will lock the keypad until the correct handset code is entered.

**“Setting” → “Security Setting” → “Phone Lock”**

1. Enter your handset code.

The default handset code is “9999”. For details on changing the handset code, see “To Change the Handset Code”.

### To Turn Off the Phone Lock

Enter your handset code during stand-by to turn the Phone Lock off.



## Settings

---

### Showing Secret Data

By setting this option on, the hidden data can be displayed.

**“Settings” → “Security Settings” → “Show Secret Data”**

1. Select “On” to display or “Off” to hide.

### Memory Settings (M 12–9)

#### Viewing the Memory Status

**“Settings” → “Memory Settings” → “Memory Status”**

1. Select from “Handset” or “Memory Card”.

The memory status of the selected item is displayed.

#### Formatting Memory Card

**“Settings” → “Memory Settings” → “Format Card”**

1. Enter your handset code.

The default handset code is “9999”. For details on changing the handset code, see “To Change the Handset Code” on page 199.

2. Press [Yes] to start formatting.

---

## Master Reset (M 12–10)

You can reset M5 and M12 settings or all settings from M1 to M12 and all created data.

### Resetting M5 and M12 Settings

***“Settings” → “Master Reset” → “Reset Settings”***

1. Enter your handset code.

The default handset code is “9999”. For details on changing the handset code, see “To Change the Handset Code” on page 199.

### Resetting All Settings from M1 to M12

***“Settings” → “Master Reset” → “Reset All”***

1. Enter your handset code.

The default handset code is “9999”. For details on changing the handset code, see “To Change the Handset Code” on page 199.

## Call Log (M 11)

---



The phone will record the last 10 missed calls, received calls and dialled numbers.

### Viewing Call Log

#### “Call Log”

1. Select from “All Calls”, “Dialled Numbers”, “Missed Calls” or “Received Calls”.

The selected call log list is displayed.

To switch logs, press  or .

2. Select the phone number you wish to view.

If you wish to dial the number, press .

#### Tip

- You can also confirm call logs by pressing  during stand-by.

### Sending Messages

1. In the call log list, highlight the call log you wish to send a message to.

2. Press [Options] and select “Create Message”.

For details on creating a message, see “Creating a New Message” on page 87.

#### Note

- The Postcard service is not available with some service providers. Please contact your service provider for more information.

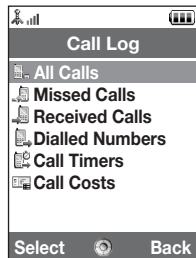

**Deleting a Call Log**

1. In the call log list, press [Options] and select “Delete”.

**Call Timers (M 11–5)**

This function lets you check the duration of your calls.

**Checking the Duration of the Last Call and All Calls**

*“Call Log”* → *“Call Timers”*

1. Select “Received Calls” or “Dialled Numbers”.

The duration of the last call and all calls is displayed.

**Resetting Call Timers**

*“Call Log”* → *“Call Timers”* → *“Clear Timers”*

1. Enter your handset code.

The default handset code is “9999”. For details on changing the handset code, see “To Change the Handset Code” on page 199.

### Call Costs (M 11–6)

This function lets you check the charges for your calls. *Some networks do not support Charging Advice. Please check with your service provider for availability.*

#### Checking the Cost of the Last Call

**“Call Log”** → **“Call Costs”** → **“Last Call”**

The cost of the last call is displayed.

#### Checking the Total Call Cost

**“Call Log”** → **“Call Costs”** → **“All Calls”**

The cost of all calls is displayed.

#### Setting the Charge Rate

Set the charge rate to calculate the call cost and set the maximum limit for call cost.

**“Call Log”** → **“Call Costs”** → **“Cost Units”** → **“Set Units”**

1. Enter your PIN2 code.
2. Enter a currency unit (up to 3 characters).
3. Enter a cost per unit.

To enter a decimal point, press

**Setting the Charge Limit**

This function is useful if you wish to make sure you do not exceed a certain charge limit.

***“Call Log” → “Call Costs” → “Max Cost” → “Set Limit”***

1. Enter your PIN2 code.
2. Enter a value.

**Checking the Residual Credit**

***“Call Log” → “Call Costs” → “Residual Credit”***

**Resetting All Call Costs**

***“Call Log” → “Call Costs” → “Clear Costs”***

1. Enter your PIN2 code.

## Connectivity (M 10)

---

By configuring the settings in this menu, you can connect to *Bluetooth* wireless technology or infrared enabled phones via these connections, as well as a PC via *Bluetooth* wireless technology or infrared connections.

### Bluetooth (M 10-1)

For using the *Bluetooth* wireless function, you need to search for other *Bluetooth* wireless technology enabled devices to establish contact with your phone. Keep your phone within a distance of 10 metres before searching.

#### Using the Bluetooth Wireless Function

To Turn On or Off

**“Connectivity” → “Bluetooth” → “Switch On/Off”**

1. Select “On” or “Off”.

The *Bluetooth* wireless setting is activated, and “” is displayed.

To Show or Hide Your Phone

**“Connectivity” → “Bluetooth” → “Visibility”**

1. Select the desired visibility settings.

“Show My Phone”:

Allows other devices to recognise your phone.

“Hide My Phone”:

Hides your phone from other devices.

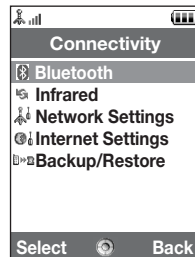

To Search for Devices to be Paired

**“Connectivity” → “Bluetooth” → “Search for Devices”**

The phone starts searching for devices within 10 metres. A maximum of 16 devices can be searched for and listed on the displayed.

1. Select the desired device for pairing.
2. Enter the device passcode.

**Note**

- *If the Bluetooth wireless function is off before searching, the phone turns the Bluetooth wireless function on automatically and starts searching.*
- *You can only select one device for pairing. To change the paired device, see “Handsfree Devices”.*

Handsfree Devices

You can activate, rename and delete the paired handsfree device in the list.

To Activate a Device

**“Connectivity” → “Bluetooth” → “Handsfree Devices”**

1. Select the device you wish to activate.



## Connectivity

---

### **Tip**

- You can save battery power by turning the Bluetooth wireless function off while it is not in use. Turn the Bluetooth wireless function off in “To Turn On or Off” on page 206 or in “To Turn Off Automatically” on page 211.
- During a call, you can divert voice calls to the paired device. Press [Options] and select “Enable Bluetooth” or “Disable Bluetooth”. If you wish to disconnect the paired device, select “Off”.

To Rename a Device

**“Connectivity” → “Bluetooth” → “Handsfree Devices”**

1. Highlight the device you wish to rename.
2. Press [Options] and select “Change Name”.
3. Rename the device.

To Clear a Device Name

**“Connectivity” → “Bluetooth” → “Handsfree Devices”**

1. Highlight the device you wish to clear.
2. Press [Options] and select “Delete”.

### Paired Devices

You can rename and delete the paired device in the list.

***“Connectivity” → “Bluetooth” → “Paired Devices”***

1. Highlight the desired device.
2. Press [Options].
3. Select “Change Name” or “Delete”.

You can rename or delete by pressing  after selecting desired device.

### To Send All Data to Other Devices

You can send all the data for applications such as Contacts List, Calendar, Tasks or etc. to selected devices.

***“Connectivity” → “Bluetooth” → “Send All”***

1. Select the desired device.

If a device is not specified, searching starts automatically.

2. Enter your handset code.

The default handset code is “9999”. For details on changing the handset code, see “To Change the Handset Code” on page 199.

## Connectivity

---

3. Enter the device passcode for unpaired devices.
4. Select the desired data to send.

### **Note**

- *If the handsfree device is connected, the confirmation screen to deactivate the handsfree function is displayed. Press [Yes] to deactivate.*

### **Bluetooth Wireless Settings**

With this setting you can rename your phone, prevent other phones from recognising your phone, turn the *Bluetooth* wireless function off automatically to save battery power, etc.

#### To Rename Your Phone

You can rename your phone. The name is shown in other devices when your phone is detected.

**“Connectivity” → “Bluetooth” → “Bluetooth Settings” → “Device Name”**

1. Enter the new device name.

To Turn Off Automatically

***“Connectivity” → “Bluetooth” → “Bluetooth Settings” → “Bluetooth Timeout”***

1. Select the desired time.

Your phone turns the function off automatically in the specified time.

To Switch the Handsfree Settings

You can switch modes of the handsfree kit between two modes; talking with the handsfree kit or talking with the phone.

***“Connectivity” → “Bluetooth” → “Bluetooth Settings” → “Handsfree Setting”***

1. Select “Private mode” or “Handsfree mode”.

“Private mode”: For talking with the handset

“Handsfree mode”: For talking with the handsfree kit

### Infrared (M 10–2)

In order to use the infrared function, you need to search for other infrared enabled devices to establish contact with your phone. Keep your phone within a distance of 20 centimetres before searching. The infrared setting will return to off when no data is transmitted/received via infrared communication.

#### Turning On or Off

***“Connectivity” → “Infrared” → “Switch On/Off”***

1. Select “On” or “Off”.

The infrared setting is activated, and “” is displayed.

#### Sending All Data

***“Connectivity” → “Infrared” → “Send All”***

1. Enter your handset code.

The default handset code is “9999”. For details on changing the handset code, see “To Change the Handset Code” on page 199.

2. Select the desired data to send.
3. Enter the authorisation code.

## Network Settings (M 10–3)

### System Settings

To Select a System Automatically

Each time the power is turned on, your phone always performs the selected system.

***“Connectivity” → “Network Settings” → “System Settings”***

1. Select “Auto”.

To Set the System Manually

***“Connectivity” → “Network Settings” → “System Settings”***

1. Select “GSM”.

### Network Settings

To Select a Network Automatically

Each time the power is turned on, your phone always tries to connect to the preferred network.

If your phone is not connected to the network, you can perform the following immediately to establish the preferred network connection.

***“Connectivity” → “Network Settings” → “Network Settings” → “Select Network” → “Automatic”***

## Connectivity

---

To Set the Network Manually

***“Connectivity” → “Network Settings” → “Network Settings” → “Select Network” → “Manual”***

1. Select the desired network.

To Add a New Network

***“Connectivity” → “Network Settings” → “Network Settings” → “Select Network” → “Add New Network”***

If there are no entries, press  and go to step 2.

If there is an entry, press  and perform the following steps.

1. Select “Add”.
2. Enter the country code.  
Up to 3 digits code can be entered.
3. Enter the network code.  
Up to 3 digits code can be entered.
4. Enter a new network name.  
Up to 25 characters can be entered.
5. Select “Select network type”.
6. Select the desired network.

---

To Change the Position of a Network in the Preferred List

***“Connectivity” → “Network Settings” → “Network Settings” → “Select Network” → “Set Preferred”***

1. Select the name of the network you wish to change the position in the list.
2. Select “Insert” to insert over the selected position or “Add to end” to insert at the end.

To Delete a Network from the Preferred List

***“Connectivity” → “Network Settings” → “Network Settings” → “Select Network” → “Set Preferred”***

1. Select the name of the network you wish to delete.
2. Select “Delete”.

To Cut the Network Connection

***“Connectivity” → “Network Settings” → “Network Settings” → “Off Line Mode”***

1. Select “On” or “Off”.

To Show the Network Information

***“Connectivity” → “Network Settings” → “Network Settings” → “Network Information”***

Information about the operator name, package and services are displayed.



### Internet Settings (M 10–4)

#### Note

- In normal operations, you do not need to change the settings.
- Internet settings have already been made in your phone depending on your network operator. You may have restrictions on viewing, deleting, copying or modifying the settings. Contact your network operator for details.

#### **“Connectivity” → “Internet Settings” → “Proxy”**

##### Proxy

“Proxy Name”:	Proxy name (Unique name)
“IP Address”:	IP address
“Access Point”:	Access point
“Home”:	Home page URL
“Port Number”:	Port number (1-65535)
“Authentication Type”:	Authentication Type (“HTTP-BASIC” or “HTTP-DIGEST”)
“User Name”:	User name for authentication
“Password”:	Password for authentication

#### **“Connectivity” → “Internet Settings” → “Access Point”**

##### Access Point

“Access Point Name”:	Access point name (Unique name)
“APN”:	APN setting
“Authentication Type”:	Authentication type (“NONE”, “PAP” or “CHAP”)
“User Name”:	User name for access point
“Password”:	Password for access point
“DNS”:	DNS setting
“Linger Time”:	Linger time setting

**“Connectivity” → “Internet Settings” → “Re-Provisioning Settings”****Re-Provisioning Settings**

“Execute Pending”: Updates provisioning data.

**“Connectivity” → “Internet Settings” → “Clear DNS Cache”**

Clears the DNS cache.

**“Connectivity” → “Internet Settings” → “White List”****White List:**

“SMSC Address”: SMSC address

“SM Originating Address”: SM originating address

**Application Settings****“Connectivity” → “Internet Settings” → “Application”****WAP Settings**

“Profile Name”: WAP profile name (Unique name)

“Proxy”: Proxy setting for WAP

**MMS Settings**

“Profile Name”: MMS profile name (Unique name)

“Proxy”: Proxy setting for MMS

“Relay Server URL”: MMS relay server

## Connectivity

---

### Email Settings

“Account Name”:	Email account name (Unique name)
“POP3”:	Server name, user ID, password and port number for POP3 server
“SMTP”:	Server name, user ID, password, port number for SMTP server and SMTP Authentication
“Access Point”:	Access point for email
“Email Address”:	Email address

### Streaming Settings

“Profile Name”:	Profile name for streaming (Unique name)
“Proxy Address”:	Proxy address
“Port Number”:	Port number (1-65535)
“Access Point”:	Access point

To Activate the WAP/MMS/Email/Streaming Profile

**“Connectivity” → “Internet Settings” → “Application”**

1. Select “WAP Settings”, “MMS Settings”, “Email Settings” or “Streaming Settings”.
2. Highlight the desired profile.
3. Press [Options] and select “Activate”.

---

To Edit the WAP/MMS/Email/Streaming Profile

***“Connectivity”*** → ***“Internet Settings”*** → ***“Application”***

1. Select “WAP Settings”, “MMS Settings”, “Email Settings” or “Streaming Settings”.
2. Highlight the desired profile.
3. Press [Options] and select “Edit”.
4. Edit the desired item.

To Copy the WAP/MMS/Email/Streaming Profile

***“Connectivity”*** → ***“Internet Settings”*** → ***“Application”***

1. Select “WAP Settings”, “MMS Settings”, “Email Settings” or “Streaming Settings”.
2. Highlight the desired profile.
3. Press [Options] and select “Copy”.
4. Edit the new profile name.

To Delete the WAP/MMS/Email/Streaming Profile

***“Connectivity”*** → ***“Internet Settings”*** → ***“Application”***

1. Select “WAP Settings”, “MMS Settings”, “Email Settings” or “Streaming Settings”.
2. Highlight the desired profile.
3. Press [Options] and select “Delete”.
4. Press [Yes].

### Backup/Restore (M 10–5)

With a memory card inserted in your phone, you can make backup files of Bookmarks, Text, Contacts, Calendar and Tasks in the handset memory card to the memory card. You can also restore the backup data from the memory card.

#### Making a Backup File on the Memory Card

***“Connectivity” → “Backup/Restore” → “Backup”***

1. Enter your handset code.

The default handset code is “9999”. For details on changing the handset code, see “To Change the Handset Code” on page 199.

2. Press [OK].
3. Select the desired item to backup.

To Backup All Files

***“Connectivity” → “Backup/Restore” → “Backup”***

1. Enter your handset code.
2. Press [OK].
3. Select “Select All”.

**Restoring a Backup File*****“Connectivity” → “Backup/Restore” → “Restore”***

1. Enter your handset code.
2. Press [OK].
3. Select the desired item.
4. Select the desired file to restore.

A confirmation message indicates deletion from the memory card is displayed on the screen.

5. Press [Yes].

To Restore All Files

***“Connectivity” → “Backup/Restore” → “Restore”***

1. Enter your handset code.
2. Press [OK].
3. Select “Select All”.

A confirmation message indicating deletion from the memory card is displayed on the screen.

4. Press [Yes].

## Connectivity

---

To Delete a Backup File

***“Connectivity”*** → ***“Backup/Restore”*** → ***“Restore”***

1. Enter your handset code.
2. Press [OK].
3. Select the desired item.
4. Highlight the desired file.
5. Press [Options] and select “Delete”.  
A confirmation message to delete the selected file is displayed on the screen.
6. Press [Yes].

You can use the following functions by connecting the 902SH to your PC using an infrared port, USB port\* or *Bluetooth* wireless technology port:

- 3G/GSM GPRS modem
- Handset Manager for 902SH

\* Requires an optional USB data cable XN-1DC30 for USB port connection.

### System Requirements

Operating System:

Windows® 98\*, Windows® Me, Windows® 2000\*\*, Windows® XP\*\*\*

\* Windows® 98 Second Edition, Windows® 98 Service Pack 1 with Internet Explorer 5.01 or later

\*\* Service Pack 4

\*\*\* Service Pack 1a

Supported Software:

Microsoft® Outlook/Outlook Express

Interface:

Infrared port, USB port or *Bluetooth* wireless port

CD-ROM drive



### 3G/GSM GPRS Modem

You can use 902SH as a 3G/GSM GPRS modem to access the Internet from your PC. Connect your phone to your PC via *Bluetooth* wireless technology or USB interface. Software installation on your PC is required. For details, see “Software Installation” on page 225.

#### Modem via the USB Cable

To use the modem function using a USB cable, use the cable mentioned above and see the instructions accompanying the cable.

#### Modem via Bluetooth connection

To use the modem function via *Bluetooth* wireless technology interface, see “Using the Bluetooth Wireless Function” on page 206 and turn the modem function on.

For details on software support, refer to the following site:

<http://www.sharp-mobile.com>

#### Note

- *Modem communication is not possible while communicating with the Handset Manager via Bluetooth wireless technology, infrared or USB interface.*
- *Your phone exhausts the battery when connected to a PC, even when not communicating.*

### Handset Manager

You can transmit the following items between your phone and your PC, and can use Contacts List entries on your PC:

- My Items files (pictures/sounds/video clips/Other Documents data)
- Contacts List entries
- Schedule entries

To use the Handset Manager function, see “Connecting 902SH to Your PC” on page 223 and set your phone to Data Transfer mode.

For details on software support, refer to the following site:

<http://www.sharp-mobile.com>

### Software Installation

1. Insert the supplied CD-ROM into your CD-ROM drive.

The 902SH CD-ROM screen is displayed.

If the 902SH CD-ROM screen is not displayed, double-click [Launcher.exe] in your CD-ROM.

2. Press the desired button.

The installation starts.

3. Follow the on-screen instructions to complete installation.

## Connecting 902SH to Your PC

---

### **Note**

- The phone may not recognise the USB data cable if it is connected while an application (Camera, My Items, etc.) is running. Connect the USB data cable during stand-by.

### **Infrared communication**

- Infrared ports need to be aligned with each other.
- Infrared ports need to be placed within 20 cm of each other and within a 30° angle.

### **3G/GSM GPRS modem**

- It is not recommended that you make or answer calls when you are using 902SH as a 3G/GSM GPRS modem. The operation may be interrupted.

### **Handset Manager**

- Some large files may not be able to be transmitted from the PC to the phone.
- Applications (Camera, My Items, etc.) do not run when the phone is connected to the PC via Bluetooth wireless technology interface, infrared port or USB data cable.

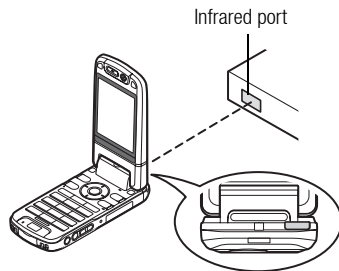

Problem	Solution
The phone does not turn on.	<ul style="list-style-type: none"> <li>• Make sure the battery is properly inserted and charged.</li> </ul>
PIN code or PIN2 code is rejected.	<ul style="list-style-type: none"> <li>• Make sure you have entered the correct code (4 to 8 digits).</li> <li>• Your SIM/USIM card/protected functions will become locked after three unsuccessful attempts.</li> <li>• Contact your SIM/USIM provider if you do not have the correct PIN code.</li> </ul>
The SIM/USIM card becomes locked.	<ul style="list-style-type: none"> <li>• Enter the PUK code (8 digits) provided by your service provider (if supported).</li> <li>• If the attempt is successful, enter the new PIN code and confirm your phone is operational again. Otherwise contact your dealer.</li> </ul>
The display is difficult to read.	<ul style="list-style-type: none"> <li>• Adjust the backlight brightness for the display.</li> </ul>
Phone functions do not work after the phone is turned on.	<ul style="list-style-type: none"> <li>• Check the radio signal strength indicator as you may be outside the service area.</li> <li>• Check to see if any error message is displayed when you turn your phone on. If so, contact your dealer.</li> <li>• Make sure the SIM/USIM card is correctly inserted.</li> </ul>
Calls cannot be made or received.	<ul style="list-style-type: none"> <li>• If the message “SIM card error” is displayed when the phone is switched on, you cannot use your SIM/USIM card or the SIM/USIM card is damaged. Contact your dealer or network service provider.</li> <li>• Check your call barring, fixed dialling setting, remaining battery and call forwarding settings.</li> <li>• Check if your phone is currently performing data communication using Infrared (IrDA), <i>Bluetooth</i> wireless technology interface or a USB data cable.</li> <li>• Check the remaining balance if you are using a pre-paid SIM/USIM card.</li> </ul>
Call quality is poor.	<ul style="list-style-type: none"> <li>• Your current location may not provide good call quality (i.e., in a car or train). Move to a location where radio signal strength is greater.</li> </ul>

## Troubleshooting

---

Problem	Solution
Cannot access network service.	<ul style="list-style-type: none"><li>• Check where your account has been registered and where the service is available.</li></ul>
Cannot send or receive text message.	<ul style="list-style-type: none"><li>• Make sure you are correctly subscribed for the Short Message Service, that the network supports this service, and that the centre number is set up correctly. If not, contact your network service provider.</li></ul>
Cannot connect to Multimedia Messaging Service provider.	<ul style="list-style-type: none"><li>• MMS settings and configuration may be missing or incorrect or the network does not support it. Check your service provider's access point number. Contact your service provider to confirm the correct settings.</li></ul>
Limited memory available.	<ul style="list-style-type: none"><li>• Delete any unnecessary data.</li></ul>
Call is terminated unexpectedly.	<ul style="list-style-type: none"><li>• Magnetised objects such as health necklaces placed near the phone may terminate the call. Keep your phone away from such objects.</li></ul>
No entries are displayed in the Contacts List.	<ul style="list-style-type: none"><li>• Confirm that the Contacts Location setting (Handset or SIM/USIM) is made correctly.</li></ul>
Fax transmission failure	<ul style="list-style-type: none"><li>• Before transmitting fax data, configure your fax software to use the software flow control.</li><li>• Use of the optional data cable is recommended for transmitting fax data.</li></ul>
Cannot receive OBEX data.	<ul style="list-style-type: none"><li>• The OBEX data can only be received only during stand-by. The message "Please return to stand-by." is displayed.</li></ul>

## Safety Precautions and Conditions of Use

---

Your phone conforms to international regulations insofar as it is used under normal conditions and in accordance with the following instructions.

### CONDITIONS OF USE

#### Electromagnetic waves

- Do not switch on your phone aboard an aircraft (as your phone may interfere with the aircraft's electronic systems). Current legislation forbids this use and legal action can be taken against the user.
- Do not switch on your phone in a hospital, except in designated areas.
- Use of your phone's function may affect the performance of medical electronic units (pacemakers, hearing aids, insulin pumps, etc.). When the phone function is on, do not bring it near medical equipment or into areas in which medical equipment is being used. If you have a hearing aid or a pacemaker, only use the phone on the opposite side of your body from where it is located. The phone should be kept at least 6 inches (15.24 cm) from a pacemaker ANYTIME the phone is switched on.
- Do not switch on your phone near gas or flammable substances.
- Observe the rules concerning the use of mobile phones at gasoline stations, chemical plants and at all sites where a risk of explosion exists.

## Safety Precautions and Conditions of Use

---

### **Caring for your phone**

- Do not allow children to use your phone without supervision.
- Do not open or attempt to repair your phone yourself. The product can only be repaired by authorised service personnel.
- Do not drop your phone or subject it to severe impacts. Bending the body and pushing the display or keys with extreme force could damage the phone.
- Do not use solvents to clean your phone. Use only a soft, dry cloth.
- Do not carry your phone in your back pocket as it could break when you sit down. The display is made of glass and is particularly fragile.
- Avoid touching the external connector on the underside of the phone, since the delicate components within can be damaged by static electricity.

### **Battery**

- Use your phone only with batteries, chargers and accessories recommended by the manufacturer. The manufacturer disclaims any liability for damage caused by the use of other chargers, batteries or accessories.

- **Network configuration and phone usage will affect talk–time and stand–by time.**

Using the games or camera will hasten battery consumption.

- **When the battery charging alert is displayed on the screen, charge the battery as soon as possible.** If you continue using your phone ignoring the alert, the phone may cease to function, and all data and settings you have stored may be lost at any moment.
- Before removing the battery from the phone, make sure the phone is switched off.
- Replace and charge the new battery as soon as possible after removing the old one.
- Do not touch the battery terminals. Batteries can cause damage, injury or burns if a conductive material touches exposed terminals. When the battery is detached from the phone, use a cover made of non-conductive material for keeping and carrying the battery safely.
- Recommended temperature for using and storing batteries is approximately 20°C.
- The batteries' performance is limited in low temperatures, particularly below 0°C and the phone may not work temporarily regardless of the amount of remaining battery power.
- Exposing the phone to extreme temperatures will shorten battery life.



## Safety Precautions and Conditions of Use

---

- The battery can be charged and discharged hundreds of times but it will eventually wear out. When the operating time (talk-time and stand-by time) is noticeably shorter than normal, it is time to buy a new battery.

### CAUTION

RISK OF EXPLOSION IF BATTERY IS REPLACED  
BY AN INCORRECT TYPE,  
DISPOSE OF USED BATTERIES ACCORDING  
TO THE INSTRUCTIONS

See "Battery Disposal" on page 21.

### Aerial Care

- Do not cover the top of the phone (p. 17, No. 21) with your hand when in use as this may interfere with the performance of the built-in aerial. Call quality may deteriorate leading to shortened talk-time and stand-by time because the mobile phone has to operate on a higher power level than is necessary.

- Use only the aerial supplied or one approved by Sharp for your mobile phone. Using unauthorised or modified aerials may damage the mobile phone. Moreover, since the mobile phone may violate the appropriate regulations, it may lose performance or exceed the limitation of SAR levels.
- To avoid impaired performance, do not damage the aerial of the mobile phone.
- While talking directly to the microphone, please hold the mobile phone so that the aerial is upwards over your shoulder.
- To avoid interfering with blasting operations, please turn off the mobile phone in a blasting area or in a place where a “turn off two-way radio” sign is posted.

## Safety Precautions and Conditions of Use

---

### Camera Operation

- Learn picture quality, file formats, etc. beforehand.

The taken pictures can be saved in JPEG format.

- Be careful not to move your hand while taking pictures.

If the phone moves while taking a picture, the picture can become blurred. When taking a picture, hold the phone firmly to prevent it from moving, or use the delay timer.

- Clean the lens cover before taking a picture.

Fingerprints, oils, etc. on the lens cover hinder clear focusing. Wipe them off with a soft cloth before taking a picture.

### Others

- As with any electronic storage unit, data may be lost or corrupted under various circumstances.

- Before connecting the phone with a PC or a peripheral unit, read the operation manual for the other unit carefully.
- If the phone's battery has been removed for some time, or the phone has been reset, the unit's clock and calendar may be reinitialised. The date and time should be updated in this case.

### **ENVIRONMENT**

- Keep your phone away from extreme heat. Do not leave it on the dashboard of a car or near a heater. Do not leave it in any place that is extremely damp or dusty.
- Since this product is not waterproof, do not use it or store it where fluids such as water can splash onto it. Raindrops, water spray, juice, coffee, steam, perspiration, etc. will also cause malfunctions.

### PRECAUTIONS CONCERNING VEHICLE USE

- It is the user's responsibility to check the local laws governing the use of a mobile phone in vehicles. Pay full attention to driving. Pull off to the side of the road, park the car, and switch off the engine before making or answering a call.
- Use of your phone's function may interfere with the vehicle's electronic systems, such as the ABS anti-lock brakes or the air-bag. To ensure no such problem occurs, please check with your dealer or car manufacturer before connecting your phone.
- Only allow qualified service maintenance personnel to install the vehicle accessories.

The manufacturer disclaims any liability for damage which may result as a consequence of improper use or use contrary to the instructions contained herein.

### **SAR**

Your Sharp mobile phone has been designed, manufactured and tested so as not to exceed the limits for exposure to electromagnetic fields recommended by the Council of the European Union. These limits are part of comprehensive guidelines developed by independent scientific organisations. The guidelines include a substantial safety margin designed to assure the safety of the phone user and others and to take into account variations in age and health, individual sensitivities and environmental conditions. European standards provide for the amount of radio frequency electromagnetic energy absorbed by the body when using a mobile phone to be measured by reference to the Specific Absorption Rate (SAR). The SAR limit for the general public is currently 2 watts per kilogram averaged over 10 grams of body tissue. Your Sharp mobile phone SAR value is 0.638 watts per kilogram. This has been tested to ensure that this limit is not exceeded even when the phone is operating at its highest certified power. In use however your Sharp mobile phone may operate at less than full power because it is designed to use only sufficient power to communicate with the network.

### PRECAUTIONS FOR USE IN USA

#### **FCC Declaration of Conformity**

This mobile phone 902SH with PC/Data interface cable XN-1DC30 complies with part 15 of the FCC Rules.

Operation is subject to the following two conditions:

- (1) This device may not cause harmful interference, and
- (2) this device must accept any interference received, including interference that may cause undesired operation.

Responsible Party:

SHARP ELECTRONICS CORPORATION

Sharp Plaza, Mahwah, New Jersey 07430

TEL: 1-800-BE-SHARP

Tested To Comply With FCC Standards

FOR HOME OR OFFICE USE



#### **FCC Notice**

The phone may cause TV or radio interference if used in close proximity to receiving equipment. The FCC can require you to stop using the phone if such interference cannot be eliminated.

#### **Information To User**

This equipment has been tested and found to comply with the limits of a Class B digital device, pursuant to Part 15 of the FCC Rules. These limits are designed to provide reasonable protection against harmful interference in a residential installation. This equipment generates, uses and can radiate radio frequency energy and, if not installed and used in accordance with the instructions, may cause harmful interference to radio communications.

However, there is no guarantee that interference will not occur in a particular installation; if this equipment does cause harmful interference to radio or television reception, which can be determined by turning the equipment off and on, the user is encouraged to try to correct the interference by one or more of the following measures:

1. Reorient/Relocate the receiving antenna.
2. Increase the separation between the equipment and receiver.
3. Connect the equipment into an outlet on a circuit different from that to which the receiver is connected.
4. Consult the dealer or an experienced radio/TV technician for help.

**CAUTION:** Changes or modifications not expressly approved by the manufacturer responsible for compliance could void the user's authority to operate the equipment.

### **Exposure to Radio Waves**

#### **THIS MODEL PHONE MEETS THE GOVERNMENT'S REQUIREMENTS FOR EXPOSURE TO RADIO WAVES.**

Your wireless phone is a radio transmitter and receiver. It is designed and manufactured not to exceed the emission limits for exposure to radio frequency (RF) energy set by the Federal Communications Commission of the U.S. Government. These limits are part of comprehensive guidelines and establish permitted levels of RF energy for the general population. The guidelines are based on standards that were developed by independent scientific organizations through periodic and thorough evaluation of scientific studies. The standards include a substantial safety margin designed to assure the safety of all persons, regardless of age and health.



## Safety Precautions and Conditions of Use

---

The exposure standard for wireless mobile phones employs a unit of measurement known as the Specific Absorption Rate, or SAR. The SAR limit set by the FCC is 1.6 W/kg.\* Tests for SAR are conducted using standard operating positions specified by the FCC with the phone transmitting at its highest certified power level in all tested frequency bands.

Although the SAR is determined at the highest certified power level, the actual SAR level of the phone while operating can be well below the maximum value. This is because the phone is designed to operate at multiple power levels so as to use only the power required to reach the network. In general, the closer you are to a wireless base station antenna, the lower the power output.

Before a phone model is available for sale to the public, it must be tested and certified to the FCC that it does not exceed the limit established by the government-adopted requirement for safe exposure. The tests are performed in positions and locations (e.g., at the ear and worn on the body) as required by the FCC for each model. The highest SAR value for this model phone when tested for use at the ear is 0.530 W/kg and when worn on the body, as described in this user guide, is 0.386 W/kg. Body-worn Operation; This device was tested for typical body-worn operations with the back of the phone kept 1.5 cm from the body. To maintain compliance with FCC RF exposure requirements, use accessories that maintain a 1.5 cm separation distance between the user's body and the back of the phone. The use of belt-clips, holsters and similar accessories should not contain metallic components in its assembly.

The use of accessories that do not satisfy these requirements may not comply with FCC RF exposure requirements, and should be avoided. While there may be differences between the SAR levels of various phones and at various positions, they all meet the government requirement for safe exposure.

The FCC has granted an Equipment Authorization for this model phone with all reported SAR levels evaluated as in compliance with the FCC RF emission guidelines. SAR information on this model phone is on file with the FCC and can be found under the Display Grant section of <http://www.fcc.gov/oet/fccid> after searching on FCC ID APYHR000038.

Additional information on Specific Absorption Rates (SAR) can be found on the Cellular Telecommunications & Internet Association (CTIA) web-site at <http://www.phonefacts.net>.

- \* In the United States and Canada, the SAR limit for mobile phones used by the public is 1.6 watts/kg (W/kg) averaged over one gram of tissue. The standard incorporates a substantial margin of safety to give additional protection for the public and to account for any variations in measurements.

## Specifications and Optional Accessories

---

### Specifications

Weight:	Approximately 149 g (with battery)
Dimensions (W × H × D):	Approximately 50 × 102 × 26 mm (without protruding parts)
Battery:	Lithium Ion, 3.7 V, 870 mAh

### Optional Accessories

- Lithium Ion Battery (XN-1BT90)
- Cigarette Lighter Charger (XN-1CL30)
- USB Data Cable (XN-1DC30)
- AC Charger (XN-1QC30, XN-1QC31)
- External Antenna Cable (XN-1AT90)
- Audio Remote-Controller (XN-1AR90)
- Car Holder (XN-1CH90)
- Desktop Holder (XN-1DH90)
- Stereo Headset (XN-1HS90)
- Handsfree Microphone Unit (XN-1HU90)
- Video Cable (XN-1VC90)

The above accessories may not be available in all regions.

For details, please contact your dealer.

**Symbols**

- #/Flash Light Key 16
- \* /Shift Key 14

**A**

- Alarms 153
  - Resetting 155
  - Setting 153
- Area Info 100
  - Enabling/Disabling 100

**B**

- Backup/Restore 220
  - Making a Backup File 220
  - Restoring a Backup File 221
- Battery 20
  - Charging 22
  - Disposal 21
  - Inserting 20
  - Removing 21
- Battery Cover 17
- Battery Level Indicator 23
- Bluetooth Wireless Function 206
- Built-in Aerial 17

**C**

- Calculator 155
- Calendar
  - Creating 149
  - Deleting Schedule Entries 152
  - Editing a Schedule Entry 151

- Receiving a Schedule Entry 151
- Sending a Schedule Entry 150
- Viewing a Schedule Entry 151
- Viewing the Memory Status 152
- Call Costs 204
  - Checking the Cost of the Last Call 204
  - Checking the Residual Credit 205
  - Checking the Total Call Cost 204
  - Resetting All Call Costs 205
  - Setting the Charge Limit 205
  - Setting the Charge Rate 204
- Call Log 202
  - Deleting 203
  - Sending Messages 202
  - Viewing 202
- Call Settings 188
  - Auto Radial 194
  - Call Information 191
  - Call Waiting 190
  - Changing the Network Password 194
  - Displaying Call Timer 194
  - Diverts 188
  - Fixed Dialling No. 193
  - Minute Minder 194
  - Rejecting an Incoming Call 193
  - Restrict Calls 191
  - Showing Your Phone Number 190
- Call Timers 203
  - Checking the Duration of the Last Call and All Calls 203

- Resetting Call Timers 203
- Camera (digital/video) 70
  - Adjusting the Exposure 73, 82
  - Auto Save 79
  - Changing the Picture Size 85
  - Continuous Shoot 75
  - Focus Setting 78
  - Focus Settings 86
  - Mobile Light 73, 83
  - Recording Video Clips 80
  - Recording with Sound 85
  - Saving 78, 85
  - Selecting a Frame 76
  - Selecting the Picture Quality 77
  - Selecting the Picture Size 72
  - Selecting the Recording Time 83
  - Selecting the Scene 74
  - Selecting the Shutter Sound 77
  - Selecting Video Quality 84
  - Sending 71, 81
  - Switching to the Photo Camera Mode 84
  - Switching to the Video Camera Mode 76
  - Taking Pictures 70
  - Using the Timer 74
  - Using the Zoom Function 72, 81
  - Viewing 82
- Cell Broadcasts 98
  - Enabling/Disabling 98
  - Reading 98
  - Setting Languages 98

- Subscribing 99
- Centre Key 14, 29
- Characters 53
  - Changing the Input Languages 55
  - Changing the Input Mode 55
  - Using Templates 57
- Clear/Back Key 15
- Conditions of Use 229
- Connectivity 206
  - Bluetooth 206
  - Infrared 212
  - Internet Settings 216
  - Network Settings 213
- Contacts List 59
  - Assigning a Ringtone or a Ring Video Clip 66
  - Changing the List 60
  - Changing the List Order 61
  - Changing the Name Order 60
  - Copying 63
  - Creating 61
  - Deleting 64
  - Dialling 63
  - Editing 64
  - Finding 63
  - Manage Group 65
  - Memory Status 67
  - Receiving 69
  - Selecting the Storage Memory 61
  - Sending 68
  - Setting in the Speeddial List 67
  - Speeddial List 67
  - Viewing My Contact Details 62
- Countdown Timer
  - Editing the Countdown Time 168
- D**
- Display
  - Adjusting the Brightness of the Backlight 182
  - Assigning the Pictures 179
  - Backlight 181
  - Setting My Pictures 178
  - Setting the Display Saving 182
  - Setting the Font Weight 180
  - Setting the Greeting Message 180
  - Setting the Sub Display 184
  - Setting Video Out 183
  - Showing the Clock 181
  - Wallpaper 178
- Display Indicators 29
- Display Position
  - Normal Position 33
- E**
- Earpiece 14
- Earpiece Volume 40
- Emergency Calls 36
- End/Power Key 15
- Expenses Memo 168
  - Modifying the Category Name 169
- Recording 168
- Viewing Totals 168
- External Camera 17
- External Connector 17
- F**
- Flash Light Key 16
- Functions
  - Navigating 34
- G**
- Games & More 143
  - Activating Files with Copyright Protection (DRM) 136
  - Deleting an Application 145
  - Downloading 134
  - Executing 135
  - Java™ Information 148
  - More Games 136
  - Receiving 138
  - Sending 137
  - Setting Network Access 144
  - Setting Security Level 143
  - Settings 146
  - Switching the Screensaver On or Off 145
  - Using 134
  - Viewing Application Information 145
- H**
- Handset Code 199

Handset Lock 198

## I

Incall Menu (Video Call) 47

    Changing the Image of Yourself 47

    Muting the Microphone 47

    Swapping Images 47

    Turning the Speakers On and Off 48

    Using the Optical Zoom Function 48

    Video Call Settings 49

Incall Menu (Voice Call) 40

    Accessing SMS/MMS Menu during a  
    Call 41

    Adjusting the Earpiece Volume 40

    Call Waiting 42

    Conference Call 42

    Muting the Microphone 44

    Putting a Call on Hold 41

    Turning the Speakers On and Off 40

Infrared 212

Infrared Port 18

International Calls 37

Internet Settings 216

## J

Java™ Applications 143

## K

Keypad 16

Keypad Lock 28

## L

Language Setting 187

Left Soft Key 14

## M

Main Display 15

Master Reset 201

Media Player 110

    Music Player 110

    Switching between Music Player and

    Video Player 110

    Video Player 113

Memory Card

    Inserting 25

    Removing 26

Memory Card Slot Cover 18

Memory Settings 200

    Formatting Memory Card 200

    Viewing the Memory Status 200

Menu and Shortcut 51

Messages (MMS/SMS/Email)

    Calling the Phone Number 93

    Creating 87

    Downloading 94

    Email Settings 104

    Forwarding 95

    General Settings 101

    Locking or Unlocking 95

    MMS Settings 103

    Reading 93

    Remote Forward 95

    Replying 94

    Sending a Message in the Drafts Box 92

    Sending with Postcard 96

    SMS Settings 102

    Sorting the Messages 95

    Storing the Phone Number 93

Microphone 15

Mobile Light 17

Multimedia Key 15

Music Player 110

    Adding a File to the Playlist 111

    Adding a New Playlist 113

    Playing Back 110

    Searching a File to Be Played Back 111

    Streaming 112

My Items 117

    Bookmarks 138

    Games & More 134

    My Saved Page 138

    Other Documents 140

    Pictures 118

    Sounds & Ringtones 129

    Text Templates 139

    Videos 124

## N

Navigation Keys 14

Network Settings 213

### O

- Organiser 149
  - Alarms 153
  - Calculator 155
  - Calendar 149
  - Countdown Timer 167
  - Expenses Memo 168
  - Phone Help 169
  - Scanner 158
  - Stopwatch 162
  - Tasks 163
  - Voice Recorder 157
  - World Clock 166

### P

- PC Connection 223
  - 3G/GSM GPRS Modem 224
  - Handset Manager 225
  - Software Installation 225
  - System Requirements 223

Phone Help 169

### Pictures

- Adjusting the Size 120
- Downloading 124
- Editing 119
- Operating 121
- Saving to Contacts List Entries 119
- Sending a Picture File 121
- Switching the Memory Source 118
- Uploading 123

- Viewing 118
- Power On and Off 26
- Profiles 171
  - Activating 171
  - Any Key Answer 177
  - Assigning a Ring Video Clip File 174
  - Assigning a Ringtone 173
  - Customising 171
  - External Light Colour 177
  - Keypad Tones 175
  - Message Notification 175
  - Resetting 172
  - Ringer Volume 172
  - Vibration 176

### R

- Redialling 38
- Right Soft Key 15

### S

- Safety Precautions 229
- Scanner 158
  - Checking the Information of the Scanned Data 162
  - Creating QR Codes 160
  - Deleting the Scanned Data 161
  - Reading Barcodes 158
  - Renaming the Scanned Data 162
  - Scanning Texts 160
- Screensavers 145
  - Setting Applications 146

### Security 197

- Changing the PIN2 Code 198
- Enabling/Disabling the PIN Code 197
- Handset Lock 198
- Phone Lock 199
  - Showing Secret Data 200
- Send/Redial Key 14
- Shortcut Key 14
- Side Keys 18
- SIM Application 170
- SIM Card 20
  - Inserting 20
  - Removing 21
- Small Light 18
- Sound Settings 185
- Sounds & Ringtones
  - Downloading 133
  - Operating 131
  - Playing Back 129
  - Sending a Sound File 130
  - Switching the Memory Source 129
  - Uploading 133
    - Using the Sound Files as a Ringtone 130
- Speed Dialling 37
- Stereo Speakers 17
- Stopwatch 162
- Sub Camera (Internal Camera) 15
- Sub Display 17
- Switching the Screensaver On or Off 145

**T**

## Tasks

- Creating 163
  - Deleting 166
  - Editing 164
  - Sending 165
  - Setting the Alarm 163
  - Viewing the Memory Status 165
- Time & Date 185
- Customising the Time Zone 186
  - Selecting the Date Format 186
  - Selecting the Time Format 186
  - Setting the Calendar Format 187
  - Setting the Daylight Saving 186
  - Setting the Time Zone 186
- Troubleshooting 227

**V**

## Video Call

- Answering 46
  - Letting the Caller Know You are Unavailable 46
  - Making 45
  - Rejecting 46
  - Status Indicators 45
- Video Call Settings 49, 195
- Assigning Hold Guidance Picture 196
  - Backlight 195
  - Mute 196
  - Selecting Picture Quality 195

- Turning On or Off the Speakers 195
- Video Clip
- Downloading 128
  - Operating 125
  - Playing Back 124
  - Sending a Video Clip File 125
  - Switching the Memory Source 124
  - Uploading 128
- VIDEO OUT/Handsfree Microphone Connector 17
- Video Player 113
- Adding a File to the Playlist 114
  - Adding a New Playlist 115
  - Backlight 116
  - Editing the Video Clip File 116
  - Playing Back Video Clip Files 113
  - Searching a File to Be Played Back 114
  - Streaming 115
- Vodafone live! 105
- Voice Call 36
- Answering 38
  - Call Waiting 42
  - Conference Call 42
  - Earpiece Volume 40
  - Making 36
  - Muting 44
  - Putting on Hold 41
  - Rejecting 39
  - Speed Dialling 37
- Voice Mail Key 14

- Voice Recorder 157
- Recording 157
  - Selecting Storage Memory 158
  - Sending 157
  - Viewing Record Time 158

**W**

## WAP Browser

- Browser Menu 107
- Navigating a WAP Page 106
- Starting 106

## World Clock

- Setting the Daylight Saving 167
- Setting the Time Zone 166



## List of Menu Functions

Menu No./ Main Menu	Menu No./ Sub Menu1
1 Games & More	1 Games 2 Screensavers 3 Settings 4 Java™ Information
2 Vodafone live!	
3 Media Player	
4 Messages	1 Create New 2 Inbox 3 Drafts 4 Templates 5 Sent 6 Outbox 7 live! Studio 8 Messenger 9 Voice Mail 10 Cell Broadcasts 11 Area Info 12 Settings 13 Memory Status
5 Camera	
6 My Items	1 Pictures 2 Videos 3 Sounds & Ringtones 4 Games & More 5 Bookmarks 6 My Saved Page 7 Text Templates 8 Other Documents

Menu No./ Main Menu	Menu No./ Sub Menu1
7 Organiser	1 Calendar 2 Alarms 3 Calculator 4 Voice Recorder 5 Scanner 6 Stopwatch 7 Tasks 8 World Clock 9 Countdown Timer 10 Expenses Memo 11 Phone Help
8 Contacts	1 Contacts List 2 Manage Group 3 Speeddial List 4 My Contact Details 5 Advanced
9 SIM Application	
10 Connectivity	1 Bluetooth 2 Infrared 3 Network Settings 4 Internet Settings 5 Backup/Restore

---

Menu No./ Main Menu	Menu No./ Sub Menu1
11 Call Log	1 All Calls 2 Missed Calls 3 Received Calls 4 Dialed Numbers 5 Call Timers 6 Call Costs
12 Settings	1 Profiles 2 Display Settings 3 Sound Settings 4 Time & Date 5 Language 6 Call Settings 7 Video Call Settings 8 Security Settings 9 Memory Settings 10 Master Reset