

VA-10 / VA-11

Brief Installation Guide

(A complete user's manual is also available
via browsing the Driver & Utilities CD.)

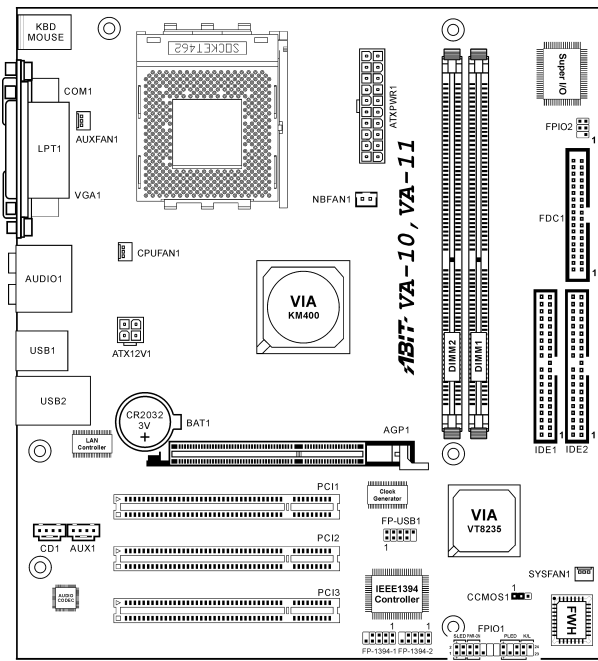

Features & Specifications

Processor

- Supports AMD Athlon XP Socket A Processors with 333/266 MHz Front Side Bus
- Supports AMD K7 Athlon™ XP FSB 333/266MHz Processors

Chipset

- VIA KM400 / VT8235 chipset
- Supports Hi-Speed Universal Serial Bus (USB 2.0)
- Int. S3 UniChrome™ 2D/3D Graphics with motion compensation
- Ext. Accelerated Graphics Port connector supports AGP 8X /4X (0.8V /1.5V)

Memory

- Two 184-pin DIMM sockets (Un-buffered Non-ECC DIMM)
- Supports 2 DIMM DDR 333/266/200 (Max. 2GB)

IEEE 1394 (For VA-11 only)

- Onboard VIA VT6307 IEEE 1394 Controller

Audio

- Onboard VIA VT1616 6-Channel AC 97 CODEC
- Professional digital audio interface supports Optical S/PDIF Out

LAN

- Onboard VIA VT6103 10/100Mbps LAN

Internal I/O Connectors

- 1x AGP slot
- 3x PCI slots
- 1x Floppy Port supports up to 2.88MB
- 2x Ultra ATA 133/100/66/33 Connectors
- 2x IEEE 1394 headers
- 1x USB 2.0 header
- 1x CD-IN, 1x AUX-IN
- 1x IrDA

Back Panel I/O

- 1x PS/2 Keyboard, 1x PS/2 Mouse
- 1x Serial Port connector
- 1x VGA Port connector
- 1x Parallel Port connector
- 1x Audio connector (S/PDIF Out, Center/Subwoofer, Surround Speaker) (Front Speaker, Line-in, MIC-in)
- 4x USB Connectors
- 1x RJ-45 LAN Connector

Miscellaneous

- uATX form factor (245 X 220 mm)
- Hardware Monitoring - Including Fan speed, Voltages, CPU and System temperature
- Supports Wake Up by LAN, Modem Ring, RTC Alarm, Keyboard and Mouse Power On

Note: All brand names and trademarks are the property of their respective owners.

Connectors, Headers, and Jumper

Note: Always power off the computer and unplug the AC power cord before adding or removing any peripheral or component. Failing to do so may cause severe damage to your motherboard and/or peripherals. Plug in the AC power cord only after you have carefully checked everything.

ATX Power Connector:

- Connects to ATX power supply.

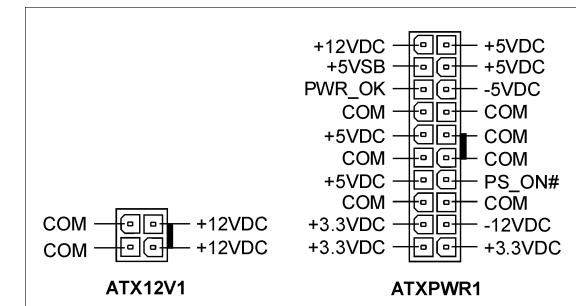

External I/O Panel:

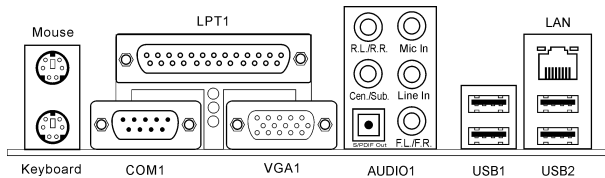

- **Mouse:** PS/2 mouse connector.
- **Keyboard:** PS/2 keyboard connector.
- **LPT1:** Parallel port connector.
- **COM1:** Serial port connector.
- **VGA1:** Monitor signal connector.
- **AUDIO1:**
 - R.L./R.R. (Rear Left / Rear Right):** Connects to the rear left and rear right channel in the 5.1 channel audio system.
 - Cent./Sub. (Center / Subwoofer):** Connects to the center and subwoofer channel in the 5.1 channel audio system.
 - S/PDIF Out:** This connector provides an S/PDIF out connection through optical fiber to digital multimedia devices.
 - Mic In:** Connects to the plug from external microphone.
 - Line In:** Connects to the line out from external audio sources.
 - F.L./F.R. (Front Left / Front Right):** Connects to the front left and front right channel in the 5.1-channel or regular 2-channel audio system.
- **LAN:** Local Area Network connector.
- **USB1/USB2:** Universal Serial Bus connector.

CMOS Memory Clearing Header:

- This header uses a jumper to clear the CMOS memory. Short pin 2 and pin 3 only when you want to clear the CMOS memory. The default setting is pin 1 and pin 2 shorted for normal operation.

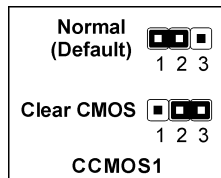

FAN Connectors:

- **CPUFAN1:** CPU Fan
- **AUXFAN1:** Auxiliary Fan
- **SYSFAN1:** System Fan
- **NBFAN1:** N.B. Chipset Fan

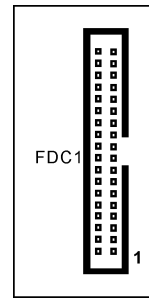

Floppy Disk Drive:

- This connector connects up to two floppy drives with a 34-wire, 2-conductor floppy cable.

Front Panel Switches & Indicators Headers:

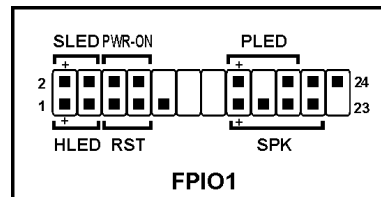

- **HLED:** Connects to the HDD LED cable of chassis front panel.
- **RST:** Connects to the Reset Switch cable of chassis front panel.
- **SPK:** Connects to the System Speaker cable of chassis.
- **SLED:** Connects to the Suspend LED cable (if there is one) of chassis front panel.
- **PWR-ON:** Connects to the Power Switch cable of chassis front panel.
- **PLED:** Connects to the Power LED cable of chassis front panel.

IDE Connector:

- Each of the IDE port connects up to two IDE drives at Ultra ATA/100 mode by one 40-pin, 80-conductor, and 3-conductor Ultra ATA/66 ribbon cables.

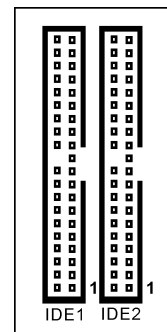

Infrared Device Header:

- This header connects to an optional infrared device attached to chassis. This motherboard supports standard infrared transfer rates.

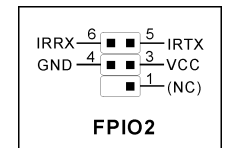

Internal Audio Connectors:

- Connects to internal audio sources.

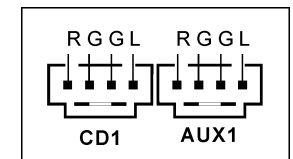

Additional IEEE1394 Port Headers: (For VA-11 only)

- These headers each provide one additional IEEE1394 port connection through an extension cable and bracket.

	Pin	Assignment	Pin	Assignment
<p>FP-1394-1 FP-1394-2</p>	1	TPA0 +	2	TPA0 -
	3	GND	4	GND
	5	TPB0 +	6	TPB0 -
	7	+12V	8	+12V
	9	NC	10	GND

Additional USB Port Header:

- This header provides two additional USB ports connection through an extension cable and bracket.

	Pin	Assignment	Pin	Assignment
<p>FP-USB1</p>	1	VCC	2	VCC
	3	Data 0 -	4	Data 1 -
	5	Data 0 +	6	Data 1 +
	7	Ground	8	Ground
	9	NC	10	NC

BIOS Setup

The "PRESS DEL TO ENTER SETUP" message appears briefly on the screen during POST sequence when powering on the computer. Press <Delete> key immediately will allow you to enter the BIOS Setup Menu.

Note: Don't change the parameters inside the BIOS Setup Menu unless you are thoroughly aware of the BIOS settings.